



**MICROCHIP**

---

**MRF24J40ME PICtail™/ PICtail  
Plus Daughter Board  
User's Guide**

---

**Note the following details of the code protection feature on Microchip devices:**

- Microchip products meet the specification contained in their particular Microchip Data Sheet.
- Microchip believes that its family of products is one of the most secure families of its kind on the market today, when used in the intended manner and under normal conditions.
- There are dishonest and possibly illegal methods used to breach the code protection feature. All of these methods, to our knowledge, require using the Microchip products in a manner outside the operating specifications contained in Microchip's Data Sheets. Most likely, the person doing so is engaged in theft of intellectual property.
- Microchip is willing to work with the customer who is concerned about the integrity of their code.
- Neither Microchip nor any other semiconductor manufacturer can guarantee the security of their code. Code protection does not mean that we are guaranteeing the product as "unbreakable."

Code protection is constantly evolving. We at Microchip are committed to continuously improving the code protection features of our products. Attempts to break Microchip's code protection feature may be a violation of the Digital Millennium Copyright Act. If such acts allow unauthorized access to your software or other copyrighted work, you may have a right to sue for relief under that Act.

---

Information contained in this publication regarding device applications and the like is provided only for your convenience and may be superseded by updates. It is your responsibility to ensure that your application meets with your specifications. MICROCHIP MAKES NO REPRESENTATIONS OR WARRANTIES OF ANY KIND WHETHER EXPRESS OR IMPLIED, WRITTEN OR ORAL, STATUTORY OR OTHERWISE, RELATED TO THE INFORMATION, INCLUDING BUT NOT LIMITED TO ITS CONDITION, QUALITY, PERFORMANCE, MERCHANTABILITY OR FITNESS FOR PURPOSE. Microchip disclaims all liability arising from this information and its use. Use of Microchip devices in life support and/or safety applications is entirely at the buyer's risk, and the buyer agrees to defend, indemnify and hold harmless Microchip from any and all damages, claims, suits, or expenses resulting from such use. No licenses are conveyed, implicitly or otherwise, under any Microchip intellectual property rights.

**Trademarks**

The Microchip name and logo, the Microchip logo, dsPIC, FlashFlex, flexPWR, JukeBlox, KEELOQ, KEELOQ logo, Kleer, LANCheck, MediaLB, MOST, MOST logo, MPLAB, OptoLyzer, PIC, PICSTART, PIC<sup>32</sup> logo, RightTouch, SpyNIC, SST, SST Logo, SuperFlash and UNI/O are registered trademarks of Microchip Technology Incorporated in the U.S.A. and other countries.

The Embedded Control Solutions Company and mTouch are registered trademarks of Microchip Technology Incorporated in the U.S.A.

Analog-for-the-Digital Age, BodyCom, chipKIT, chipKIT logo, CodeGuard, dsPICDEM, dsPICDEM.net, ECAN, In-Circuit Serial Programming, ICSP, Inter-Chip Connectivity, KleerNet, KleerNet logo, MiWi, MPASM, MPF, MPLAB Certified logo, MPLIB, MPLINK, MultiTRAK, NetDetach, Omniscient Code Generation, PICDEM, PICDEM.net, PICkit, PICtail, RightTouch logo, REAL ICE, SQI, Serial Quad I/O, Total Endurance, TSHARC, USBCheck, VariSense, ViewSpan, WiperLock, Wireless DNA, and ZENA are trademarks of Microchip Technology Incorporated in the U.S.A. and other countries.

SQTP is a service mark of Microchip Technology Incorporated in the U.S.A.

Silicon Storage Technology is a registered trademark of Microchip Technology Inc. in other countries.

GestIC is a registered trademarks of Microchip Technology Germany II GmbH & Co. KG, a subsidiary of Microchip Technology Inc., in other countries.

All other trademarks mentioned herein are property of their respective companies.

© 2015, Microchip Technology Incorporated, Printed in the U.S.A., All Rights Reserved.

ISBN: 978-1-63277-074-5

**QUALITY MANAGEMENT SYSTEM  
CERTIFIED BY DNV  
= ISO/TS 16949 =**

*Microchip received ISO/TS-16949:2009 certification for its worldwide headquarters, design and wafer fabrication facilities in Chandler and Tempe, Arizona; Gresham, Oregon and design centers in California and India. The Company's quality system processes and procedures are for its PIC<sup>®</sup> MCUs and dsPIC<sup>®</sup> DSCs, KEELOQ<sup>®</sup> code hopping devices, Serial EEPROMs, microperipherals, nonvolatile memory and analog products. In addition, Microchip's quality system for the design and manufacture of development systems is ISO 9001:2000 certified.*

**Object of Declaration: MRF24J40ME PICtail™/ PICtail Plus Daughter Board**

EU Declaration of Conformity

Manufacturer: Microchip Technology Inc.  
2355 W. Chandler Blvd.  
Chandler, Arizona, 85224-6199  
USA

This declaration of conformity is issued by the manufacturer.

The development/evaluation tool is designed to be used for research and development in a laboratory environment. This development/evaluation tool is not a Finished Appliance, nor is it intended for incorporation into Finished Appliances that are made commercially available as single functional units to end users under EU EMC Directive 2004/108/EC and as supported by the European Commission's Guide for the EMC Directive 2004/108/EC (8<sup>th</sup> February 2010).

This development/evaluation tool complies with EU RoHS2 Directive 2011/65/EU.

This development/evaluation tool, when incorporating wireless and radio-telecom functionality, is in compliance with the essential requirement and other relevant provisions of the R&TTE Directive 1999/5/EC and the FCC rules as stated in the declaration of conformity provided in the module datasheet and the module product page available at [www.microchip.com](http://www.microchip.com).

For information regarding the exclusive, limited warranties applicable to Microchip products, please see Microchip's standard terms and conditions of sale, which are printed on our sales documentation and available at [www.microchip.com](http://www.microchip.com).

Signed for and on behalf of Microchip Technology Inc. at Chandler, Arizona, USA

  
Derek Carlson  
VP Development Tools

12-Sep-14  
Date

# MRF24J40ME PICtail™/ PICtail Plus Daughter Board User's Guide

---

---

NOTES:



# MRF24J40ME PICtail™/PICtail PLUS DAUGHTER BOARD USER'S GUIDE

---

---

## Table of Contents

---

---

<b>Preface</b> .....	<b>7</b>
<b>Chapter 1. Overview</b>	
1.1 Introduction .....	13
1.2 MRF24J40ME PICtail™/PICtail Plus Daughter Board Contents .....	13
1.3 MRF24J40ME PICtail™/PICtail Plus Daughter Board .....	13
<b>Chapter 2. Getting Started</b>	
2.1 Introduction .....	15
2.2 Plugging into the PIC18 Explorer Board .....	15
2.3 Plugging into the Explorer 16 Development Board .....	16
2.4 Downloading and Running the Demo Program .....	17
<b>Appendix A. PIC18F1220/1320 Schematics</b>	
A.1 Introduction .....	19
A.2 MRF24J40ME PICtail™/PICtail Plus Daughter Board Schematic .....	20
A.3 MRF24J40ME PICtail™/PICtail Plus Daughter Board PCB Layout .....	21
A.4 MRF24J40ME PICtail™/PICtail Plus Daughter Board Bill of Materials .....	23
<b>Worldwide Sales and Service</b> .....	<b>24</b>

# MRF24J40ME PICtail™/PICtail Plus Daughter Board User's Guide

---

---

NOTES:



# MRF24J40ME PICtail™/PICtail PLUS DAUGHTER BOARD USER'S GUIDE

---

---

## Preface

---

---

### NOTICE TO CUSTOMERS

All documentation becomes dated, and this manual is no exception. Microchip tools and documentation are constantly evolving to meet customer needs, so some actual dialogs and/or tool descriptions may differ from those in this document. Please refer to our web site ([www.microchip.com](http://www.microchip.com)) to obtain the latest documentation available.

Documents are identified with a “DS” number. This number is located on the bottom of each page, in front of the page number. The numbering convention for the DS number is “DSXXXXXXXXA”, where “XXXXXXXX” is the document number and “A” is the revision level of the document.

For the most up-to-date information on development tools, see the MPLAB® IDE online help. Select the Help menu, and then Topics to open a list of available online help files.

## INTRODUCTION

- [Document Layout](#)
- [Conventions Used in this Guide](#)
- [Recommended Reading](#)
- [The Microchip Web Site](#)
- [Development Systems Customer Change Notification Service](#)
- [Customer Support](#)
- [Revision History](#)

## DOCUMENT LAYOUT

This document describes how to use the MRF24J40ME PICtail™/ PICtail Plus Daughter Board as a development tool to emulate and debug firmware on a target board, as well as how to program devices. The document is organized as follows:

- **Chapter 1. “Overview”**– This chapter provides a brief overview of the MRF24J40ME PICtail™/ PICtail Plus Daughter Board, including board contents and features.
- **Chapter 2. “Getting Started”** – This chapter describes how to start using your MRF24J40ME PICtail™/ PICtail Plus Daughter Board.
- **Appendix A. “MRF24J40ME PICtail™/ PICtail Plus Daughter Board Schematics”**– This appendix contains the schematics, PCB information and Bill of Materials for the MRF24J40ME PICtail™/ PICtail Plus Daughter Board.

## CONVENTIONS USED IN THIS GUIDE

This manual uses the following documentation conventions:

### DOCUMENTATION CONVENTIONS

Description	Represents	Examples
Italic characters	Referenced books	<i>MPLAB® IDE User's Guide</i>
	Emphasized text	...is the <i>only</i> compiler...
Initial caps	A window	the Output window
	A dialog	the Settings dialog
	A menu selection	select Enable Programmer
Quotes	A field name in a window or dialog	"Save project before build"
Underlined, italic text with right angle bracket	A menu path	<u><i>File &gt; Save</i></u>
Bold characters	A dialog button	Click <b>OK</b>
	A tab	Click the <b>Power</b> tab
Text in angle brackets < >	A key on the keyboard	Press <Enter>, <F1>
Plain Courier New	Sample source code	#define START
	Filenames	autoexec.bat
	File paths	c:\mcc18\h
	Keywords	_asm, _endasm, static
	Command-line options	-Opa+, -Opa-
	Bit values	0, 1
	Constants	0xFF, 'A'
<i>Italic Courier New</i>	A variable argument	<i>file.o</i> , where <i>file</i> can be any valid filename
Square brackets [ ]	Optional arguments	mcc18 [options] <i>file</i> [options]
Curly brackets and pipe character: {   }	Choice of mutually exclusive arguments; an OR selection	errorlevel {0 1}
Ellipses...	Replaces repeated text	var_name [, var_name...]
	Represents code supplied by user	void main (void) { ... }
Notes	A Note presents information that we want to re-emphasize, either to help you avoid a common pitfall or to make you aware of operating differences between some device family members. A Note can be in a box, or when used in a table or figure, it is located at the bottom of the table or figure.	<b>Note:</b> This is a standard note box.
		<b>CAUTION</b> This is a caution note. Note 1: This is a note used in a



## RECOMMENDED READING

This user's guide describes how to use MRF24J40ME PICtail™/ PICtail Plus Daughter Board. Other useful documents are listed below. The following Microchip documents are available and recommended as supplemental reference resources.

**MRF24J40 IEEE 802.15.4 2.4 GHz RF Transceiver Data Sheet (DS30009776)**

**MRF24J40MD/ME 2.4 GHz IEEE Std. 802.15.4™ RF Transceiver Module with PA/LNA (DS70005173)**

**PICDEM™ PIC18 Explorer Demonstration Board User's Guide (DS50001721)**

**Explorer 16 Development Board User's Guide (DS50001589)**

**2K SPI Bus Serial EEPROM with EUI-48™ Node Identity Data Sheet (DS20002123)**

## THE MICROCHIP WEB SITE

Microchip provides online support via our web site at [www.microchip.com](http://www.microchip.com). This web site is used as a means to make files and information easily available to customers. Accessible by using your favorite Internet browser, the web site contains the following information:

- **Product Support** – Data sheets and errata, application notes and sample programs, design resources, user's guides and hardware support documents, latest software releases and archived software
- **General Technical Support** – Frequently Asked Questions (FAQs), technical support requests, online discussion groups, Microchip consultant program member listing
- **Business of Microchip** – Product selector and ordering guides, latest Microchip press releases, listing of seminars and events, listings of Microchip sales offices, distributors and factory representatives

## DEVELOPMENT SYSTEMS CUSTOMER CHANGE NOTIFICATION SERVICE

Microchip's customer notification service helps keep customers current on Microchip products. Subscribers will receive e-mail notification whenever there are changes, updates, revisions or errata related to a specified product family or development tool of interest.

To register, access the Microchip web site at [www.microchip.com](http://www.microchip.com), click on Customer Change Notification and follow the registration instructions.

The Development Systems product group categories are:

- **Compilers** – The latest information on Microchip C compilers, assemblers, linkers and other language tools. These include all MPLAB C compilers; all MPLAB assemblers (including MPASM™ assembler); all MPLAB linkers (including MPLINK™ object linker); and all MPLAB librarians (including MPLIB™ object librarian).
- **Emulators** – The latest information on Microchip in-circuit emulators. This includes the MPLAB REAL ICE™ and MPLAB ICE 2000 in-circuit emulators.
- **In-Circuit Debuggers** – The latest information on the Microchip in-circuit debuggers. This includes MPLAB ICD 3 in-circuit debuggers and PICKit™ 3 debug express.
- **MPLAB® IDE** – The latest information on Microchip MPLAB IDE, the Windows® Integrated Development Environment for development systems tools. This list is focused on the MPLAB IDE, MPLAB IDE Project Manager, MPLAB Editor and MPLAB SIM simulator, as well as general editing and debugging features.
- **Programmers** – The latest information on Microchip programmers. These include production programmers such as MPLAB REAL ICE in-circuit emulator, MPLAB ICD 3 in-circuit debugger and MPLAB PM3 device programmers. Also included are non-production development programmers such as PICSTART® Plus and PICKit 2 and 3.

## CUSTOMER SUPPORT

Users of Microchip products can receive assistance through several channels:

- Distributor or Representative
- Local Sales Office
- Field Application Engineer (FAE)
- Technical Support

Customers should contact their distributor, representative or field application engineer (FAE) for support. Local sales offices are also available to help customers. A listing of sales offices and locations is included in the back of this document.

Technical support is available through the web site at:

<http://www.microchip.com/support>.

## REVISION HISTORY

### Revision A (February 2015)

This is the initial release of the MRF24J40ME PICtail™/ PICtail Plus Daughter Board User's Guide.

NOTES:

---

---

## Chapter 1. Overview

---

---

### 1.1 INTRODUCTION

The MRF24J40ME PICtail™/ PICtail Plus Daughter Board is a demonstration and development daughter board for the MRF24J40ME 2.4 GHz IEEE Std. 802.15.4™ RF Transceiver Module with PA/LNA.

The daughter board can be plugged into multiple Microchip Technology demonstration and development boards. For example, the daughter board is appropriate for 8-bit microcontroller development using the PIC18 Explorer Board (DM183032) or for 16-bit and 32-bit microcontroller development using the Explorer 16 Development Board (DM240001).

Supporting software stacks and application notes may be downloaded from the Microchip web site <http://www.microchip.com/wireless>.

This chapter discusses the following topics:

- MRF24J40ME PICtail™/ PICtail Plus Daughter Board Contents
- MRF24J40ME PICtail™/ PICtail Plus Daughter Board

### 1.2 MRF24J40ME PICtail™/PICtail PLUS DAUGHTER BOARD CONTENTS

Depending on the development tool ordered, package contents will also contain the MRF24J40ME PICtail™/PICtail Plus Daughter Board.

### 1.3 MRF24J40ME PICtail™/PICtail PLUS DAUGHTER BOARD

The MRF24J40ME PICtail™/ PICtail Plus Daughter Board is a complete IEEE 802.15.4 2.4 GHz wireless transceiver. The daughter board is shown in [Figure 1-1](#).

#### IMPORTANT

The MRF24J40ME module contains a Power Amplifier (PA) and Low Noise Amplifier (LNA). It is important that the MRF24J40 be configured to control the PA and LNA. Refer to Section 4.2 “External PA/LNA Control” in the “*MRF24J40 IEEE 802.15.4 2.4 GHz RF Transceiver Data Sheet*” (DS39776). When using the source code, refer to the compile options to enable the PA and LNA.

#### CAUTION

Power to the MRF24J40ME PICtail™/ PICtail Plus Daughter Board should be in the range of 2.7V-3.6V. Ensure that the development/demonstration board the daughter board is plugged into meets this voltage requirement; otherwise, damage to the MRF24J40 may occur.

FIGURE 1-1: MRF24J40ME PICTAIL™/ PICTAIL PLUS DAUGHTER BOARD

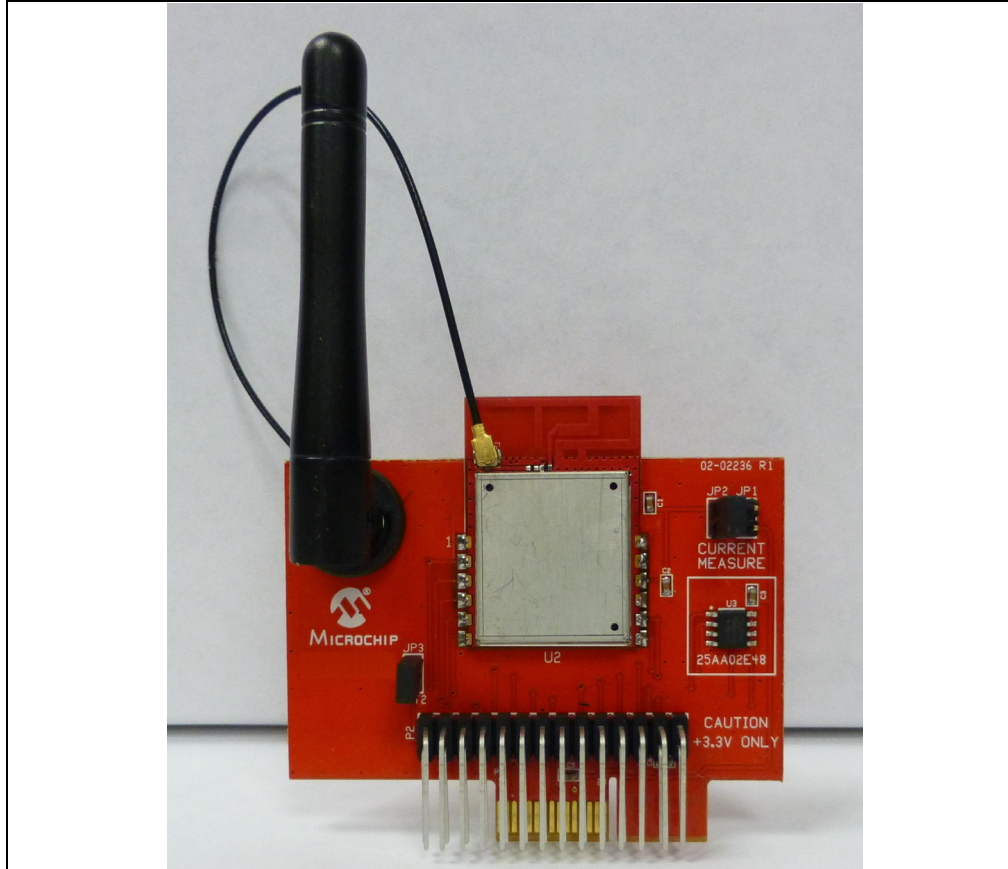

**PICtail Plus Connector (P1)** – 30-pin card edge connector for connecting into 16-bit and 32-bit development boards' PICtail Plus connectors.

**PICtail Connector (P2)** – 28-pin right angle connector to connect to 8-bit development boards' PICtail connector.

**MRF24J40ME (U2)** – 2.4 GHz IEEE 802.15.4 RF Transceiver Module.

**Power Disconnect/Current Measure Jumpers (JP1/JP2)** – Two 2-pin headers are connected in parallel. A shunt on one of the two headers connects power to the MRF24J40ME module. A current meter can be placed on the open header and when the shunt is removed from the opposite header, current consumption can be measured without interrupting power. A useful cable that can be connected to the 2-pin header and current meter, using banana plugs, is the XLP Current Measurement Cable (AC002023).

**External Antenna** – 2 dBi dipole whip antenna (P/N RFA-02-L2H1-70B-150 from Aristotle Enterprises Inc.).

**INT2 Jumper (JP3)** – Jumpering JP3 with a shunt allows you to connect RA5 to RB2/INT2. This enables push button switch S2 on the PIC18 Explorer to trigger an interrupt. For more information, see [Section 2.2.1 "Configuring Push Button Switch S2 to RB2/INT2"](#).

**EUI Node Identity Serial EEPROM (U3)** – Contains a unique IEEE EUI address. For more information, refer to the "2K SPI Bus Serial EEPROM with EUI-48™ Node Identity Data Sheet" (DS22123).

---

---

## Chapter 2. Getting Started

---

---

### 2.1 INTRODUCTION

The MRF24J40ME PICtail™/ PICtail Plus Daughter Board can be plugged into multiple Microchip Technology demonstration and development boards. This allows the developer to choose the microcontroller that best suits the customer's development environment.

The PICtail connector right-angle header, P2, can be plugged into the PIC18 Explorer Board (DM183032), which is an 8-bit demonstration and development board. The PICtail Plus card-edge connector, P1, can be plugged into the 16-bit or 32-bit Explorer 16 Development Board (DM240001).

This chapter describes how the MRF24J40ME PICtail™/ PICtail Plus Daughter Board is plugged into the PIC18 Explorer and Explorer 16 Development Boards.

### 2.2 PLUGGING INTO THE PIC18 EXPLORER BOARD

The MRF24J40ME PICtail™/ PICtail Plus Daughter Board can be plugged into the PIC18 Explorer Board PICtail connector, J3, as shown in [Figure 2-1](#). Make sure to align pin 1 to RE2 as shown.

#### IMPORTANT

The MRF24J40ME module contains a Power Amplifier (PA) and Low Noise Amplifier (LNA). It is important that the MRF24J40 be configured to control the PA and LNA. For more information, refer to Section 4.2 "External PA/LNA Control in the *MRF24J40 IEEE 802.15.4 2.4 GHz RF Transceiver Data Sheet*" (DS39776). When using the source code, refer to the compile options to enable the PA and LNA.

#### CAUTION

Ensure that the PIC18F87J11 PIM is plugged into the PIC18 Explorer Board. This sets the system VDD voltage to 3.3 volts, which is required by the MRF24J40ME PICtail™/ PICtail Plus Daughter Board.

#### 2.2.1 Configuring Push Button Switch S2 to RB2/INT2

On the PIC18 Explorer Board, push button switch S2 is normally connected to I/O port pin RA5. RA5 is not an interrupt-on-change or external interrupt capable I/O pin. Jumping JP3 with a shunt allows the connection of RA5 to RB2/INT2 to allow push button switch S2 to trigger an interrupt. Remember that RB2 also connects to pin 10 (input) of U6 (RS232 level shifter), which is a Clear-to-Send (CTS) signal on P2 pin 8 (DE9 receptacle).

**FIGURE 2-1: MRF24J40ME PICtail™/ PICtail Plus Daughter Board PLUGGED INTO PIC18 EXPLORER BOARD**

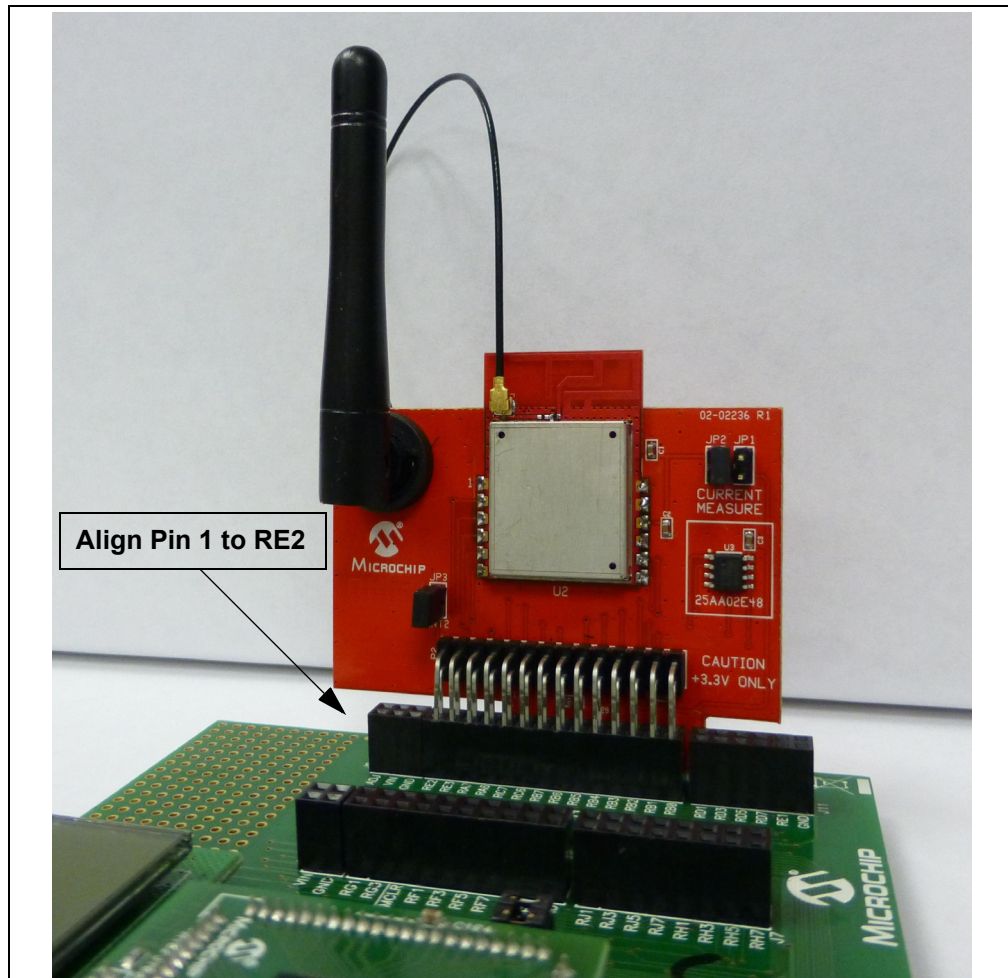

## 2.3 PLUGGING INTO THE EXPLORER 16 DEVELOPMENT BOARD

The MRF24J40ME PICtail™/ PICtail Plus Daughter Board can be plugged into the Explorer 16 Development Board as shown in [Figure 2-2](#).

To communicate through SPI Port 1 on the plug-in module socket's PIC® microcontroller, plug the MRF24J40ME PICtail™/PICtail Plus Daughter Board into the top section of the PICtail Plus connector.

To communicate through SPI Port 2 on the plug-in module socket's PIC microcontroller, plug the MRF24J40ME PICtail™/PICtail Plus Daughter Board into the middle section of the PICtail Plus connector.



**FIGURE 2-2: MRF24J40ME PICtail™/ PICtail Plus Daughter Board PLUGGED INTO EXPLORER 16 DEVELOPMENT BOARD**

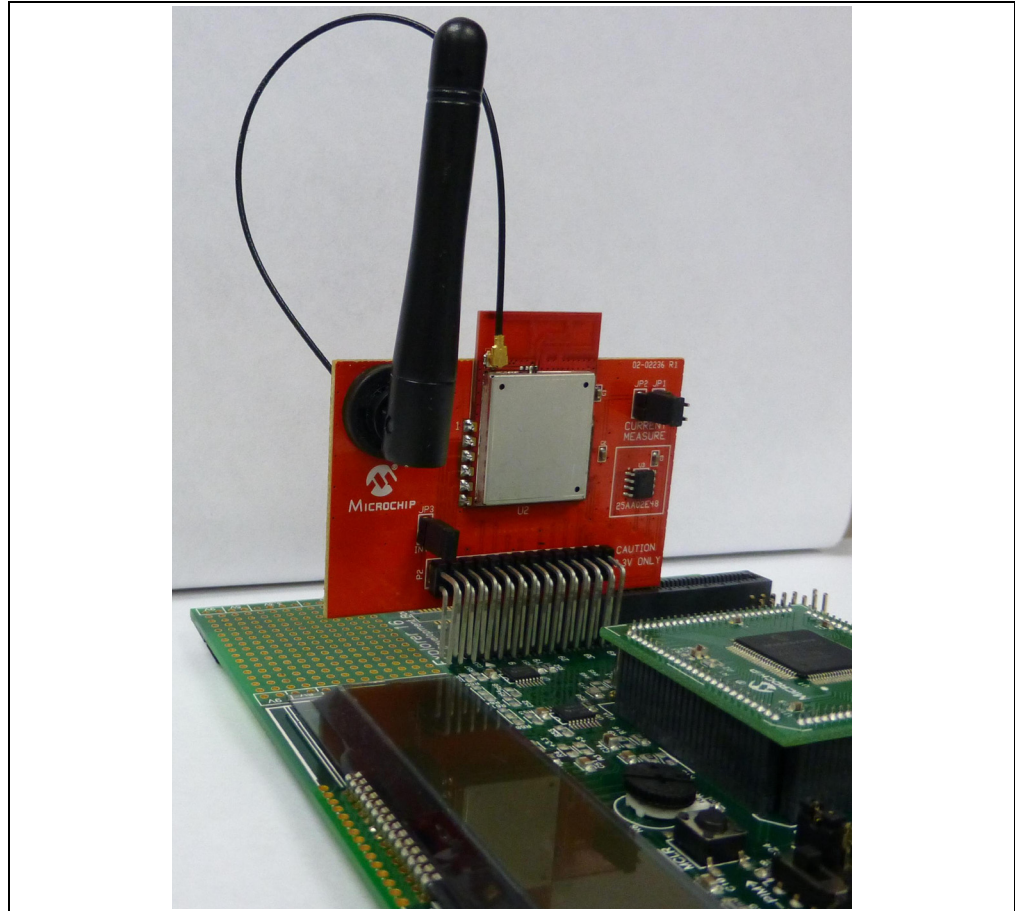

## 2.4 DOWNLOADING AND RUNNING THE DEMO PROGRAM

Sample source code is available from the Microchip Wireless Development Environment, MiWi™ Media Access Controller (MiMAC) and MiWi Application Programming Interface (MiApp). For detailed descriptions of MiMAC and MiAPP, refer to the application notes AN1283 “*Microchip Wireless (MiWi™) Media Access Controller – MiMAC*” (DS01283A) and AN1284 “*Microchip Wireless (MiWi™) Application Programming Interface – MiApp*” (DS01284A). A Quick Start Guide is included in the software installation package that explains the installation and operation of the demonstration program. It may be downloaded from the Microchip web site <http://www.microchip.com/miwi>.

**NOTES:**



# MRF24J40ME PICtail™/PICtail PLUS DAUGHTER BOARD USER'S GUIDE

---

---

## Appendix A. MRF24J40ME PICtail™/ PICtail Plus Daughter Board Schematics

---

---

### A.1 INTRODUCTION

This appendix provides the MRF24J40ME PICtail™/PICtail Plus Daughter Board schematics, PCB layout and Bill of Materials (BOM) and the following figures:

[Figure A-1: “MRF24J40ME PICtail™/PICtail Plus Daughter Board Schematic”](#)

[Figure A-2: “MRF24J40ME PICtail™/PICtail Plus Daughter Board Top Silkscreen”](#)

[Figure A-3: “MRF24J40ME PICtail™/PICtail Plus Daughter Board Top Copper”](#)

[Figure A-4: “MRF24J40ME PICtail™/PICtail Plus Daughter Board Bottom Copper”](#)

[Figure A-5: “MRF24J40ME PICtail™/PICtail Plus Daughter Board Bottom Silkscreen”](#)

## A.2 MRF24J40ME PICtail™/PICtail PLUS DAUGHTER BOARD SCHEMATIC

FIGURE A-1: MRF24J40ME PICtail™/PICtail PLUS DAUGHTER BOARD SCHEMATIC

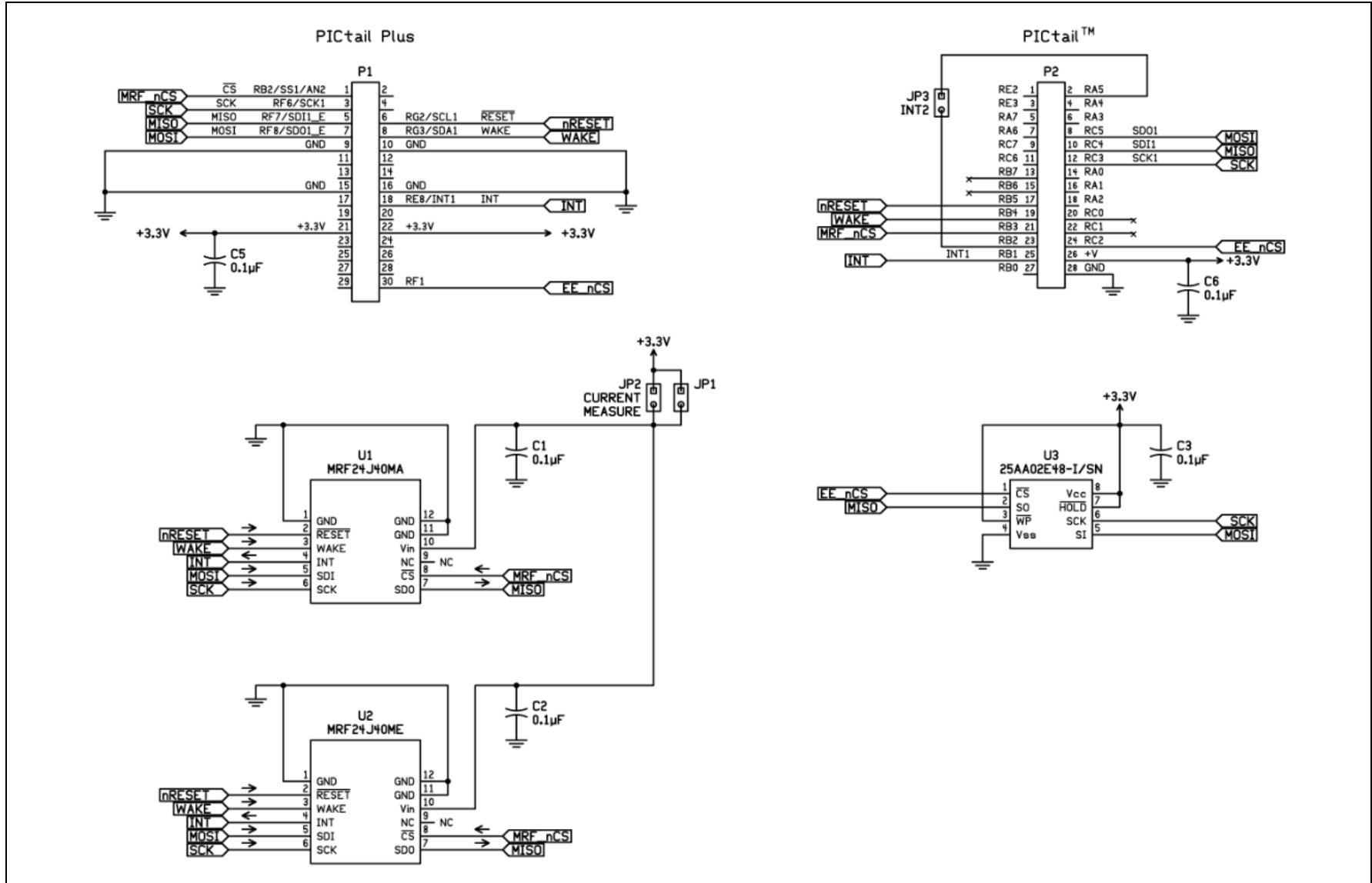

### A.3 MRF24J40ME PICtail™/PICtail PLUS DAUGHTER BOARD PCB LAYOUT

The MRF24J40ME PICtail™/PICtail Plus Daughter Board is a 2-layer, FR4, 0.062 inch, plated through hole PCB construction.

**FIGURE A-2: MRF24J40ME PICtail™/PICtail PLUS DAUGHTER BOARD TOP SILKSCREEN**

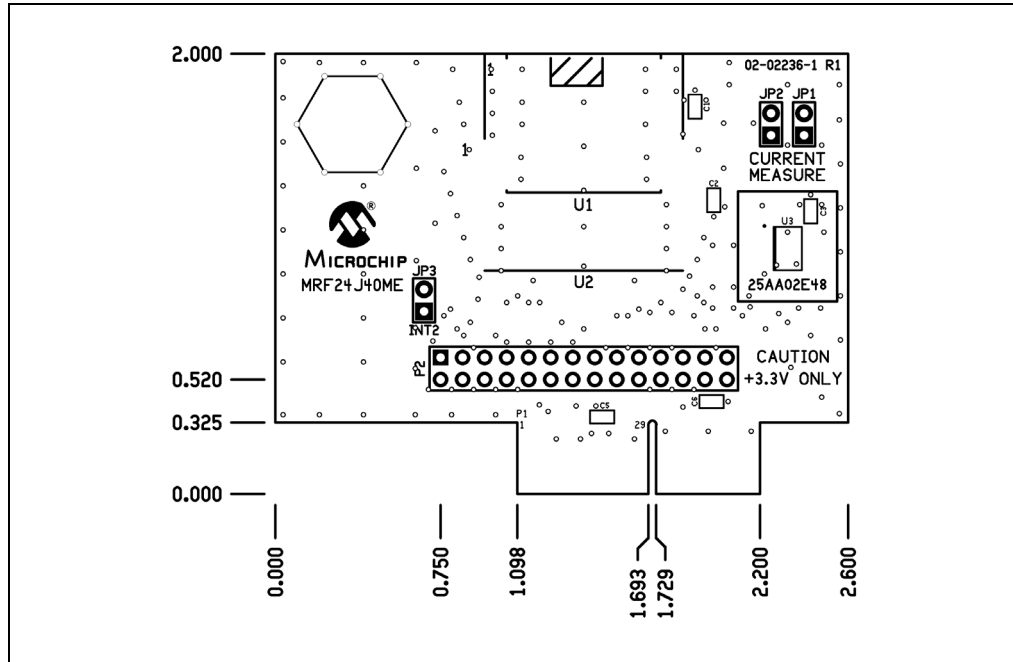

**FIGURE A-3: MRF24J40ME PICtail™/PICtail PLUS DAUGHTER BOARD TOP COPPER**

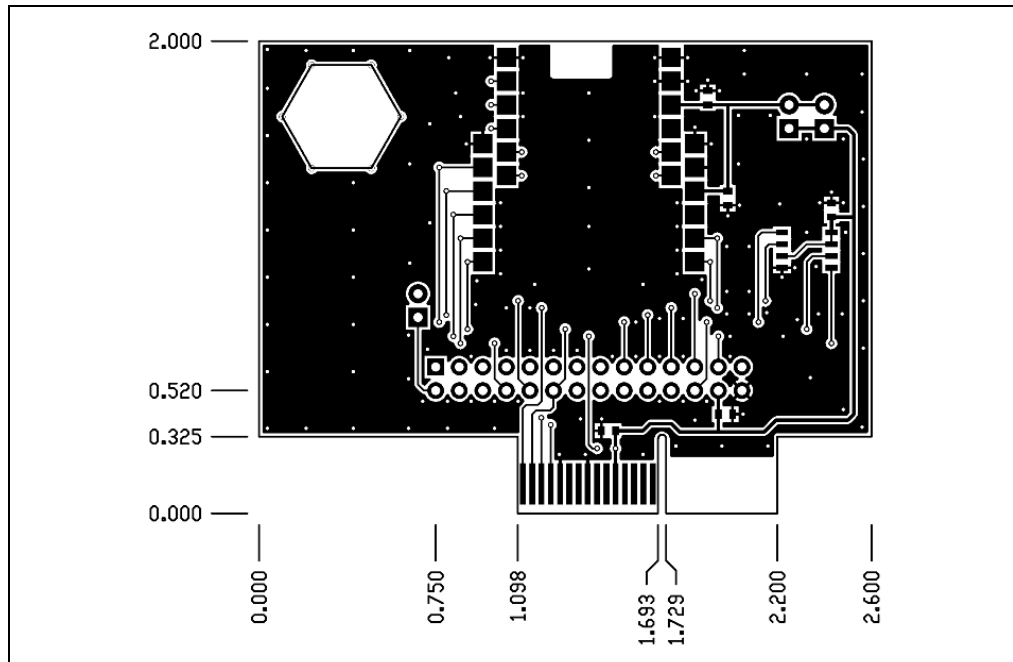

**FIGURE A-4: MRF24J40ME PICtail™/PICtail PLUS DAUGHTER BOARD BOTTOM COPPER**

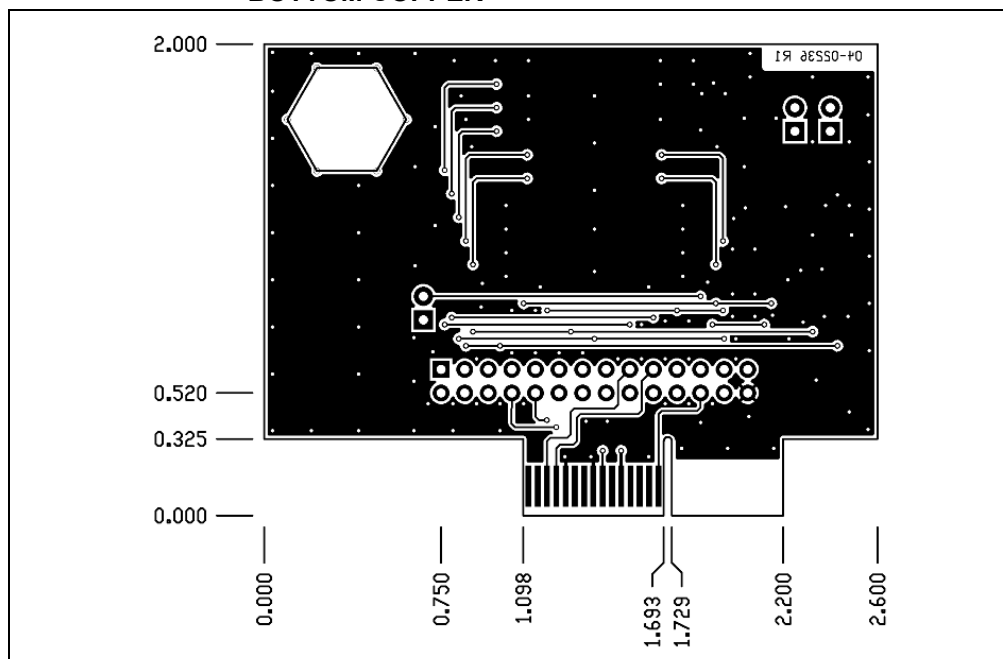

**FIGURE A-5: MRF24J40ME PICtail™/PICtail PLUS DAUGHTER BOARD BOTTOM SILKSCREEN**

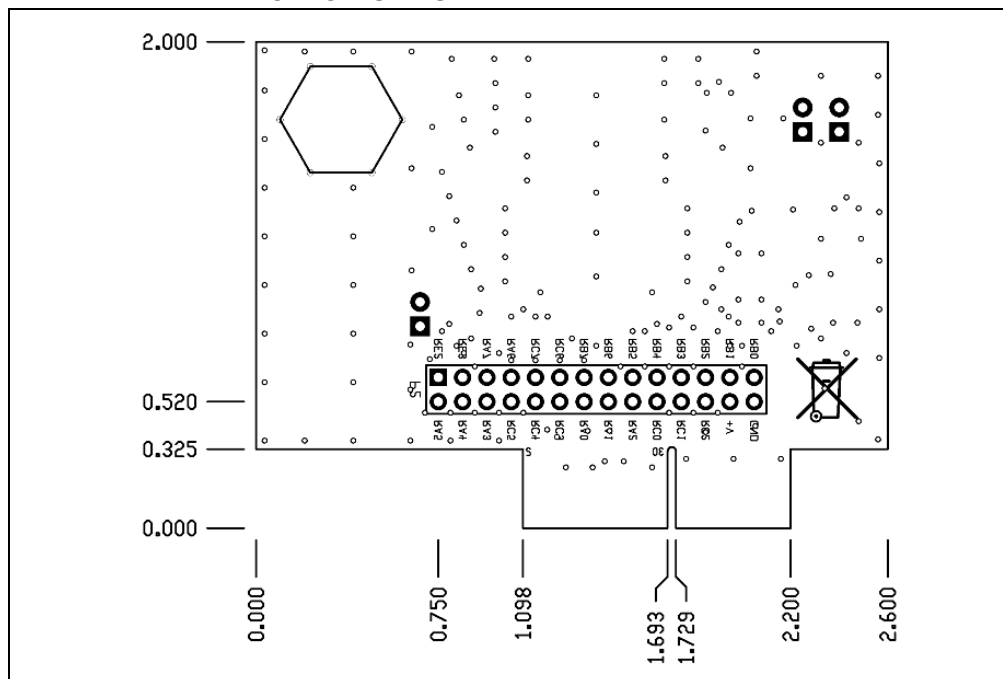

## A.4 MRF24J40ME PICtail™/PICtail PLUS DAUGHTER BOARD BILL OF MATERIALS

**TABLE A-1: MRF24J40ME PICtail™/PICtail PLUS DAUGHTER BOARD BILL OF MATERIALS**

Reference	Description	Manufacturers	Part Number	Comments
C1, C2, C3, C5, C6	0.1 µF Capacitor, Ceramic, 50V, COG, SMT 0603	Panasonic®	ECJ-1VB1C104K	Bypass capacitor
JP1, JP2, JP3	Connector, Header, 1x2, 0.100" pitch, 0.025" sq post	SPC TECHNOLOGY	SPC20481	—
Shunt	Connector, Shunt, 0.100" pitch	Sullins Connector Solutions	STC02SYAN	Shunts for JP1 and JP3
P2	Connector, Header, 2x14, 0.100" pitch, right angle 0.390/0.230	Sullins Connector Solutions	GBC14DBDN	—
U2	MRF24J40ME RF Transceiver Module	Microchip Technology	MRF24J40ME-I/RM	—
U3	EUI-48 Node Identity Serial EEPROM	Microchip Technology	25AA02E48-I/SN	—



# MICROCHIP

## Worldwide Sales and Service

### AMERICAS

#### Corporate Office

2355 West Chandler Blvd.  
Chandler, AZ 85224-6199

Tel: 480-792-7200

Fax: 480-792-7277

Technical Support:

[http://www.microchip.com/  
support](http://www.microchip.com/support)

Web Address:

[www.microchip.com](http://www.microchip.com)

#### Atlanta

Duluth, GA

Tel: 678-957-9614

Fax: 678-957-1455

#### Austin, TX

Tel: 512-257-3370

#### Boston

Westborough, MA

Tel: 774-760-0087

Fax: 774-760-0088

#### Chicago

Itasca, IL

Tel: 630-285-0071

Fax: 630-285-0075

#### Cleveland

Independence, OH

Tel: 216-447-0464

Fax: 216-447-0643

#### Dallas

Addison, TX

Tel: 972-818-7423

Fax: 972-818-2924

#### Detroit

Novi, MI

Tel: 248-848-4000

#### Houston, TX

Tel: 281-894-5983

Indianapolis

#### Noblesville, IN

Tel: 317-773-8323

Fax: 317-773-5453

#### Los Angeles

Mission Viejo, CA

Tel: 949-462-9523

Fax: 949-462-9608

#### New York, NY

Tel: 631-435-6000

#### San Jose, CA

Tel: 408-735-9110

#### Canada - Toronto

Tel: 905-673-0699

Fax: 905-673-6509

### ASIA/PACIFIC

#### Asia Pacific Office

Suites 3707-14, 37th Floor  
Tower 6, The Gateway  
Harbour City, Kowloon

#### Hong Kong

Tel: 852-2943-5100

Fax: 852-2401-3431

#### Australia - Sydney

Tel: 61-2-9868-6733

Fax: 61-2-9868-6755

#### China - Beijing

Tel: 86-10-8569-7000

Fax: 86-10-8528-2104

#### China - Chengdu

Tel: 86-28-8665-5511

Fax: 86-28-8665-7889

#### China - Chongqing

Tel: 86-23-8980-9588

Fax: 86-23-8980-9500

#### China - Dongguan

Tel: 86-769-8702-9880

#### China - Hangzhou

Tel: 86-571-8792-8115

Fax: 86-571-8792-8116

#### China - Hong Kong SAR

Tel: 852-2943-5100

Fax: 852-2401-3431

#### China - Nanjing

Tel: 86-25-8473-2460

Fax: 86-25-8473-2470

#### China - Qingdao

Tel: 86-532-8502-7355

Fax: 86-532-8502-7205

#### China - Shanghai

Tel: 86-21-5407-5533

Fax: 86-21-5407-5066

#### China - Shenyang

Tel: 86-24-2334-2829

Fax: 86-24-2334-2393

#### China - Shenzhen

Tel: 86-755-8864-2200

Fax: 86-755-8203-1760

#### China - Wuhan

Tel: 86-27-5980-5300

Fax: 86-27-5980-5118

#### China - Xian

Tel: 86-29-8833-7252

Fax: 86-29-8833-7256

### ASIA/PACIFIC

#### China - Xiamen

Tel: 86-592-2388138

Fax: 86-592-2388130

#### China - Zhuhai

Tel: 86-756-3210040

Fax: 86-756-3210049

#### India - Bangalore

Tel: 91-80-3090-4444

Fax: 91-80-3090-4123

#### India - New Delhi

Tel: 91-11-4160-8631

Fax: 91-11-4160-8632

#### India - Pune

Tel: 91-20-3019-1500

#### Japan - Osaka

Tel: 81-6-6152-7160

Fax: 81-6-6152-9310

#### Japan - Tokyo

Tel: 81-3-6880-3770

Fax: 81-3-6880-3771

#### Korea - Daegu

Tel: 82-53-744-4301

Fax: 82-53-744-4302

#### Korea - Seoul

Tel: 82-2-554-7200

Fax: 82-2-558-5932 or

82-2-558-5934

#### Malaysia - Kuala Lumpur

Tel: 60-3-6201-9857

Fax: 60-3-6201-9859

#### Malaysia - Penang

Tel: 60-4-227-8870

Fax: 60-4-227-4068

#### Philippines - Manila

Tel: 63-2-634-9065

Fax: 63-2-634-9069

#### Singapore

Tel: 65-6334-8870

Fax: 65-6334-8850

#### Taiwan - Hsin Chu

Tel: 886-3-5778-366

Fax: 886-3-5770-955

#### Taiwan - Kaohsiung

Tel: 886-7-213-7828

#### Taiwan - Taipei

Tel: 886-2-2508-8600

Fax: 886-2-2508-0102

#### Thailand - Bangkok

Tel: 66-2-694-1351

Fax: 66-2-694-1350

### EUROPE

#### Austria - Wels

Tel: 43-7242-2244-39

Fax: 43-7242-2244-393

#### Denmark - Copenhagen

Tel: 45-4450-2828

Fax: 45-4485-2829

#### France - Paris

Tel: 33-1-69-53-63-20

Fax: 33-1-69-30-90-79

#### Germany - Dusseldorf

Tel: 49-2129-3766400

#### Germany - Munich

Tel: 49-89-627-144-0

Fax: 49-89-627-144-44

#### Germany - Pforzheim

Tel: 49-7231-424750

#### Italy - Milan

Tel: 39-0331-742611

Fax: 39-0331-466781

#### Italy - Venice

Tel: 39-049-7625286

#### Netherlands - Drunen

Tel: 31-416-690399

Fax: 31-416-690340

#### Poland - Warsaw

Tel: 48-22-3325737

#### Spain - Madrid

Tel: 34-91-708-08-90

Fax: 34-91-708-08-91

#### Sweden - Stockholm

Tel: 46-8-5090-4654

#### UK - Wokingham

Tel: 44-118-921-5800

Fax: 44-118-921-5820

01/27/15