

MODEL: WSP-307008
PRODUCT: Water Resistant Speaker
EDITION: A/2017

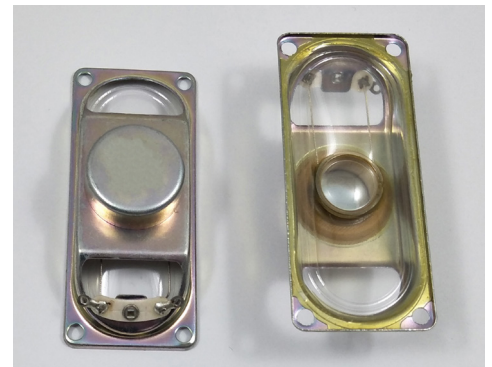

Specification	Unit	WSP-307008
AC Impedance	Ω	$8 \pm 15\%$ at 1000Hz
Rated Input Power	Watt	2.0
Max Input Power	Watt	3.0
Resonant Frequency	Hz	$650 \pm 20\%$
Frequency Range	Hz	F0 ~ 8.0KHz, Average SPL ± 10 dB
Output Sound Pressure Level	dB	93 ± 3 dB 1.0 Watt/1.0 Meter, AVG. at 0.8, 1.0, 1.2, 1.5KHz
Operating Temperature	$^{\circ}\text{C}$	$-20^{\circ}\text{C} \sim +50^{\circ}\text{C}$
Storage Temperature	$^{\circ}\text{C}$	$-40^{\circ}\text{C} \sim +60^{\circ}\text{C}$
Dimension	mm	70.4 x 30.4 x H18.4
Distortion		3% maximum at 1000Hz, 2.0W
Polarity		Diaphragm shall move forward when a positive DC current is applied to the "+" or "Marked" Terminal
Load Test		Audio Signal Generator at 4.0 Volt Total 48 hours and 20Hz ~ 20KHz resonant frequency
Abnormal Sound Test		Must be normal tested at 4.0 Volt sine wave
Ingress Rating		IP65

DIMENSIONS

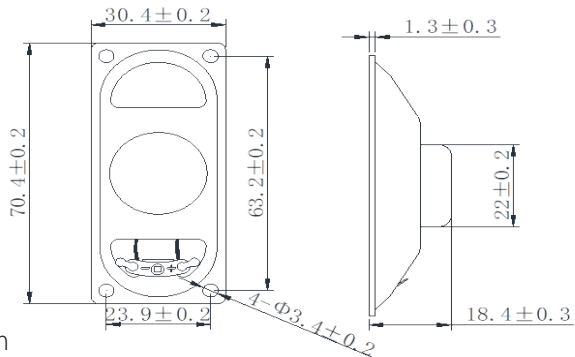

Unit: mm

FREQUENCY RESPONSE

