

# **AT85DVK-07 Development Board**

---

## **Hardware User's Guide**





---

## Section 1

Introduction .....	1-1
1.1 Overview .....	1-1
1.1.1 Typical Applications .....	1-1
1.2 AT85DVK-07 Starter Kit Content .....	1-1
1.3 AT85DVK-07 Starter Kit Information .....	1-2
1.3.1 Very Low Voltage 1.8V System .....	1-3
1.3.2 Low Voltage 3V System .....	1-3

---

## Section 2

Using the AT85DVK-07 Board .....	2-5
2.1 Development Board .....	2-5
2.2 Power Management Unit.....	2-7
2.2.1 Battery Power Supply .....	2-7
2.2.2 External Power Supply Connection .....	2-7
2.2.3 USB $V_{BUS}$ Power Supply .....	2-7
2.2.4 Power Configuration .....	2-8
2.2.5 External DC-DC Replacement.....	2-9
2.3 Microcontroller Unit .....	2-9
2.3.1 Socket.....	2-10
2.3.2 Reset .....	2-10
2.3.3 In System Programming .....	2-10
2.4 Remote Control Unit.....	2-10
2.4.1 Serial Remote Unit .....	2-10
2.4.2 Parallel Remote Unit.....	2-10
2.5 USB Unit .....	2-12
2.5.1 OTG Extension .....	2-12
2.6 Nand Flash Unit .....	2-12
2.6.1 Nand Flash Extension .....	2-13
2.6.2 On-Board Nand Flash Configuration .....	2-14
2.7 MMC/SD Unit .....	2-14
2.7.1 MMC I/O Extension .....	2-15
2.8 Audio Input Unit .....	2-15
2.9 Audio Output Unit.....	2-16
2.9.1 Headphone Amp Configuration .....	2-17
2.10 FM Receiver Unit .....	2-18
2.11 Display Unit.....	2-18
2.12 Keypad Unit .....	2-18
2.12.1 Keypad Extension.....	2-19
2.13 On-Chip Debug Unit.....	2-19

2.14	Power Consumption Measurement.....	2-19
2.15	USB Storage Device Connection.....	2-20
2.16	Nand Flash Board Extension .....	2-21
<hr/>		
<b>Section 3</b>		
	Technical Specifications .....	3-23
<hr/>		
<b>Section 4</b>		
	Development Board Errata List.....	4-25
4.1	<b>Board V1.0.0</b> .....	4-25
4.2	<b>Board V1.0.1</b> .....	4-25
<hr/>		
<b>Section 5</b>		
	Technical Support.....	5-27
5.1	Problem Reporting .....	5-27
5.2	Firmware .....	5-27
5.3	Hardware .....	5-27
5.4	Tools .....	5-28
5.5	Audio Player.....	5-28
5.6	Picture Viewer .....	5-28



# Section 1

---

## Introduction

Congratulations on your purchase of the C51 AT85DVK-07 Starter Kit. It is designed to give designers a quick start to develop code on the AT85C51SND3Bx and for prototyping and testing of new designs.

- 
- 1.1 Overview** This document describes the development board part of the AT85DVK-07 Starter Kit dedicated to the AT85C51SND3Bx microcontroller. This board is designed to allow an easy evaluation of the product using Atmel's demonstration software.
- To increase its demonstrative capabilities, this stand alone board has numerous interfaces (USB, PSI, RS232, SPI) and on-board resources (keyboard & 128x64 graphic LCD).
- This user's guide acts as a general getting started guide as well as a complete technical reference for advanced users.
- 1.1.1 Typical Applications**
- MP3/WMA/... Audio Player
  - PDA, Camera, Mobile Phone Audio Player
  - Car Audio/Multimedia Audio Player
  - Home Audio/Multimedia Audio Player
  - Karaoke
- 
- 1.2 AT85DVK-07 Starter Kit Content** The AT85DVK-07 Starter Kit contains the following items:
- a AT85DVK-07 Board V1.0.x
  - a Nand Flash daughter board equipped with one Nand Flash memory
  - a bare PCB Nand Flash daughter board for user's nand flash evaluation
  - a USB 2.0 high speed cable
  - a USB host adapter cable
  - a demonstration firmware programmed inside the Nand Flash memory
  - an OCD dongle with target cable for debugging the application

Figure 1-1. AT85DVK-07 Board Photo

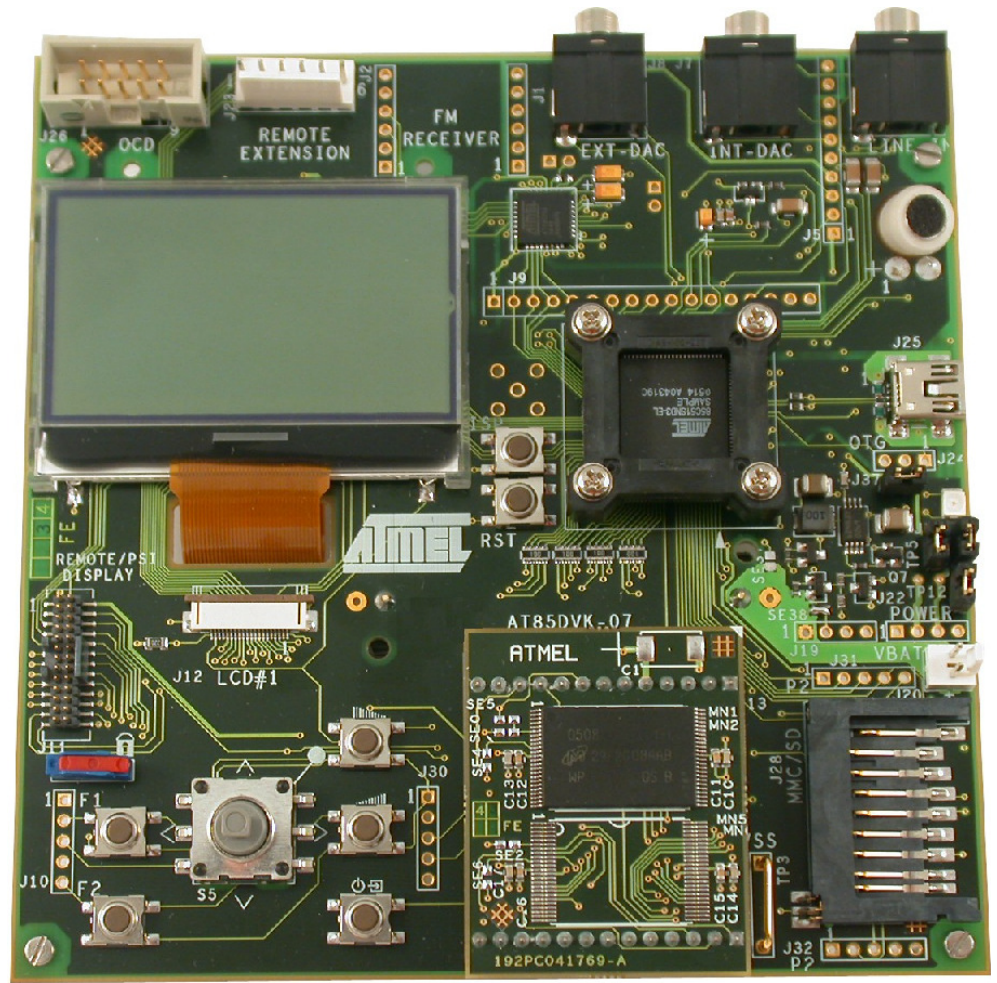

### 1.3 AT85DVK-07 Starter Kit Information

The AT85DVK-07 Starter Kit allows demonstrating of 2 typical applications which differentiate by the power supply voltage:

- The Very Low Voltage System  
The player operates at 1.8V and allows very low power consumption.
- The Low Voltage System  
The player operates at 3V and allows low power consumption.

1.3.1 Very Low Voltage 1.8V System

Figure 1-2. Typical Very Low Voltage 1.8V Application

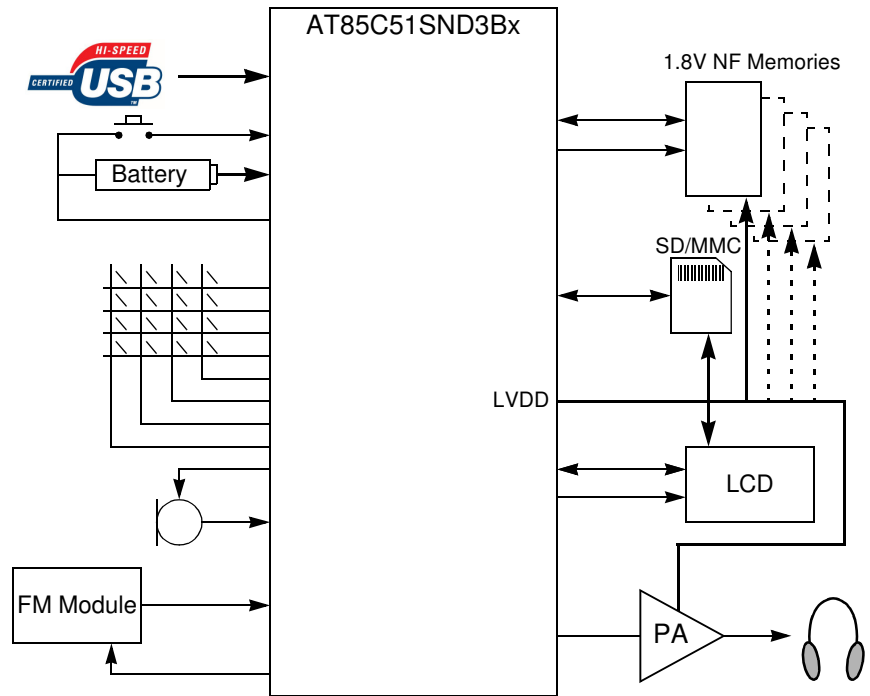

1.3.2 Low Voltage 3V System

Figure 1-3. Typical Low Voltage 3V Application

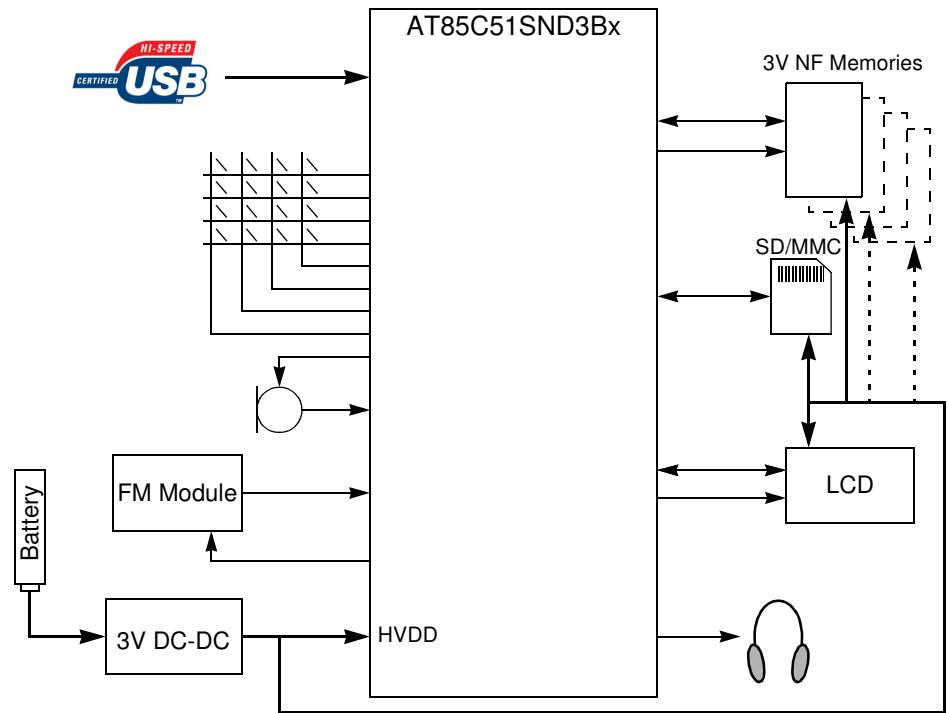



## Section 2

# Using the AT85DVK-07 Board

The AT85DVK-07 Board can be used as a stand-alone USB mass storage disk and master or slave multi-format audio player.

### 2.1 Development Board

Figure 2-1. AT85DVK-07 Board Block Diagram

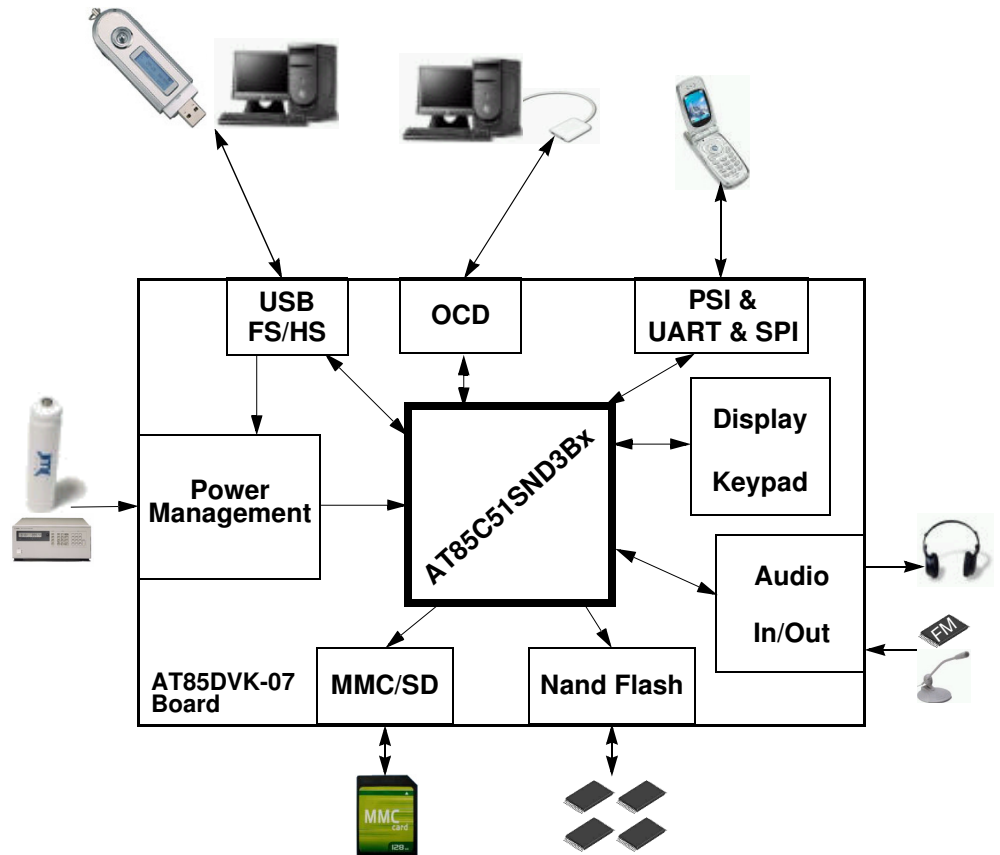
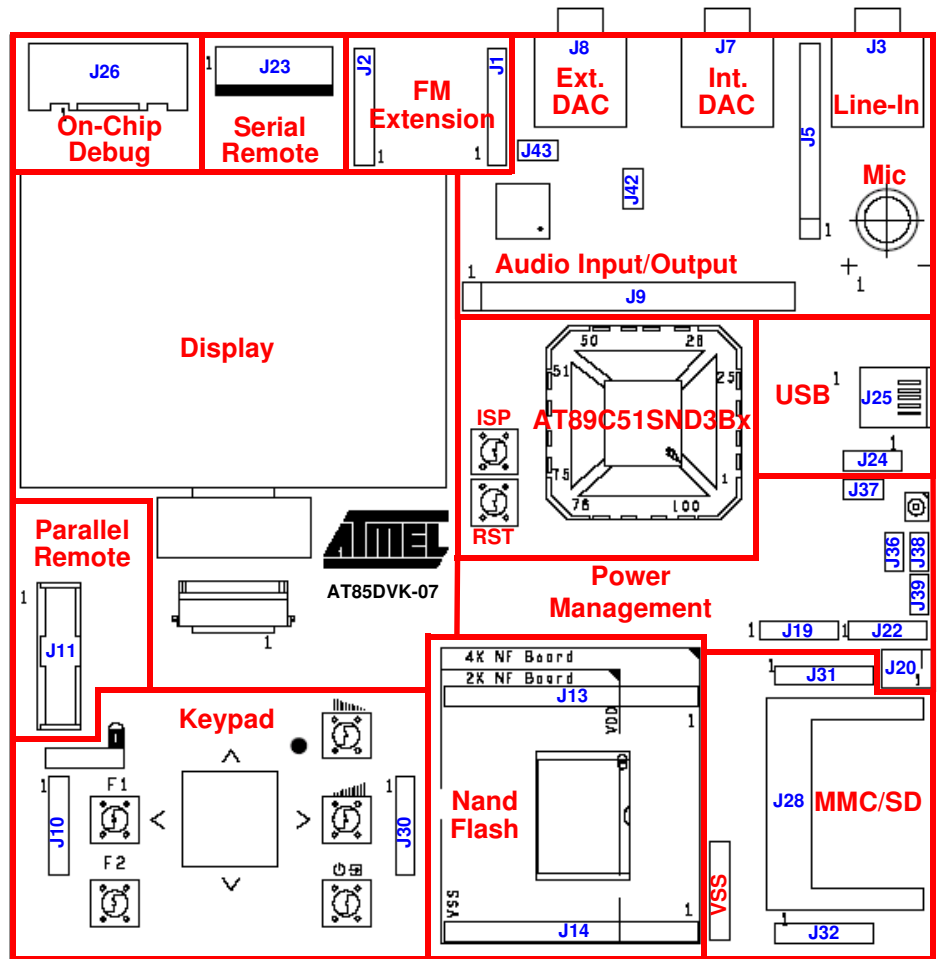

Figure 2-2. AT85DVK-07 Board





## 2.2 Power Management Unit

The Power Management unit allows three different power supply sources along with a set of solder strap allowing configuration of “Very Low Voltage 1.8V application” or “Low Voltage 3V application”. Figure 2-3 shows the power management unit implementation. Jumpers J36, J37, J38, J39 must always be in place for proper operation and are implemented for current measurement purpose only (see Section 2.14).

**Figure 2-3.** Power Management Unit Implementation

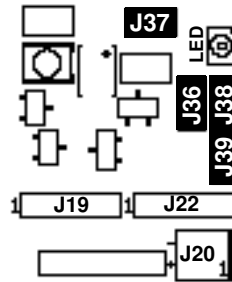

### 2.2.1 Battery Power Supply

The AT85DVK-07 Board allows direct plug-in of a single AAA battery element or a AA battery as an option.

**Table 2-1.** Battery Power Supply Range

Power supply source	Min.	Max.	Unit
Battery Power Supply	0.9	1.5	V

### 2.2.2 External Power Supply Connection

In order to operate without battery during firmware development process the AT85DVK-07 Board provides an external power supply input through connector J20.

- Notes:
1. Remove any plugged battery from the socket before applying the external voltage.
  2. The external power supply input is **not protected** against polarization inversion.

**Table 2-2.** External Power Supply Connector Pinout (J20)

Pin Number	Pin Name	Pin Description
1	VBAT	+ 1.5V supply voltage
2	VSS	0V supply reference

**Table 2-3.** External Power Supply Range

Power supply source	Min.	Max.	Unit
External Power Supply	0.9	3.0	V

**Figure 2-4.** External Power Supply Cable

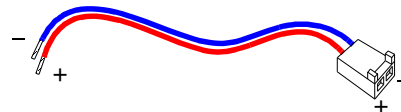

### 2.2.3 USB V<sub>BUS</sub> Power Supply

The AT85C51SND3Bx provides direct connection of USB V<sub>BUS</sub> power supply. When V<sub>BUS</sub> is present, the on-chip or on-board DC-DC is disabled to avoid battery power consumption.

**Table 2-4.** USB V<sub>BUS</sub> Power Supply Range

Power supply source	Min.	Max.	Unit
V <sub>BUS</sub> Power Supply	4.4	5.5	V

**2.2.4 Power Configuration**

The power configuration is done through a set of solder straps. By default, the AT85DVK-07 Board is delivered configured in “Low Voltage 3V application” meaning all external components (LCD, NF, MMC...) are powered at 3V.

Note: “Very Low Voltage 1.8V application” uses the on-chip 1.8V DC-DC of the AT85C51SND3Bx while “Low Voltage 3V application” uses the external on-board DC-DC.

**Table 2-5.** Power Configuration

Solder Strap	Very Low Voltage Application	Low Voltage Application	Comment
SE32	X		VDD selection amongst HVDD or LVDD
SE34		X	
SE33	X		AVDD2 selection amongst HVDD or LVDD
SE35		X	
SE37	X	X <sup>(1)</sup>	Internal / External DC-DC V <sub>BAT</sub> Selection
SE38		X <sup>(3)</sup>	
SE56		X <sup>(3)</sup>	On-board DC-DC output insulation
SE57	X	X <sup>(2)</sup>	Power-on switch routing
SE58		X	

- Notes:
- Option to allow battery voltage monitoring by the AT85C51SND3Bx.
  - Option to allow power key-press detection by the AT85C51SND3Bx.
  - Remove this connection when using a daughter board DC-DC extension.

**Figure 2-5.** Very Low Voltage Application Power Configuration

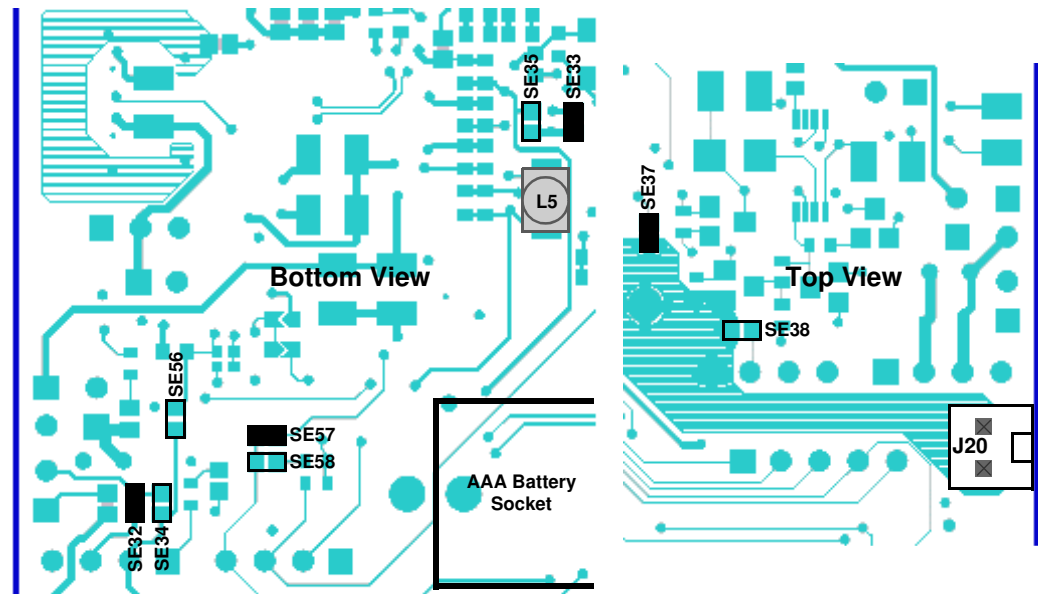

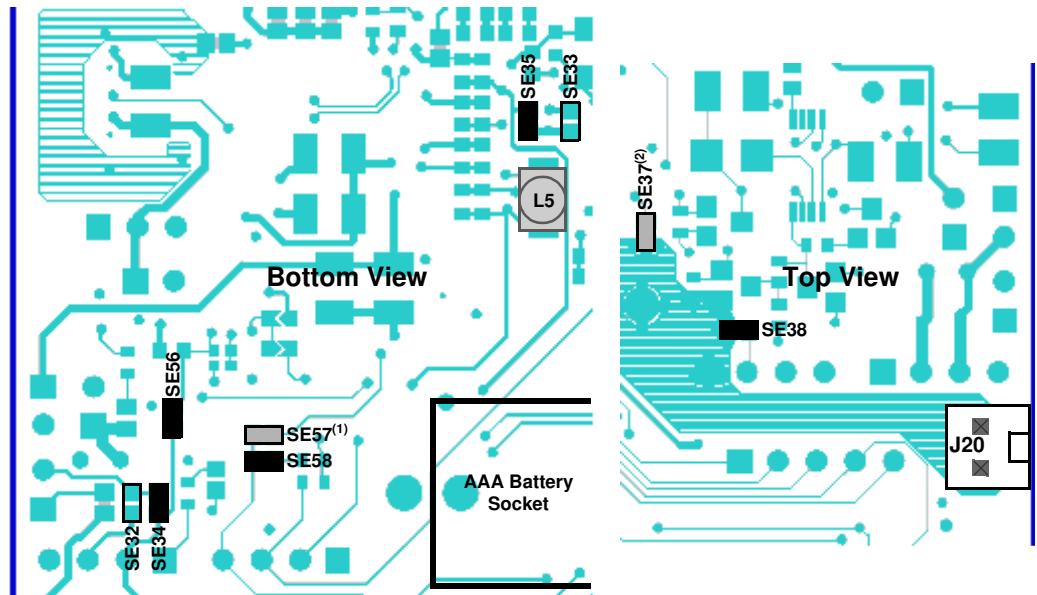
**Figure 2-6.** Low Voltage Application Power Configuration

- Notes:
1. Option to allow power key-press detection by the AT85C51SND3Bx.
  2. Option to allow battery voltage monitoring by the AT85C51SND3Bx.

### 2.2.5 External DC-DC Replacement

In order to allow developers to validate other external DC-DC power supply solution, two extension connectors J19 and J22 (see Table 2-6 and Table 2-7) are provided as option to plug a daughter board featuring an external 3V low voltage DC-DC. In such configuration the board must be configured in “Low Voltage” mode and SE38 along with SE56 must be open.

**Table 2-6.** External DC-DC Extension Connector (J19)

Pin Number	Pin Name	Pin Description
1	VBAT	Direct battery supply voltage
2	EXTDC	Battery supply voltage (SE38 ON)
3	P3.4/EXTDC_ON	Asserted low permanent power-on signal
4	SW_ON	Active low power-on switch

**Table 2-7.** External DC-DC Extension Connector (J22)

Pin Number	Pin Name	Pin Description
1	VBUS	USB +5V supply voltage
2	HVDD	3V supply voltage
3	LVDD	1.8V supply voltage
4	VSS	0V digital supply reference

## 2.3 Microcontroller Unit

The Microcontroller unit consists in the AT85C51SND3Bx component in LQFP100 pin package including its 12 MHz oscillator and the reset (RST) and in system programming (ISP) push-buttons.

**Figure 2-7.** Microcontroller Unit Implementation

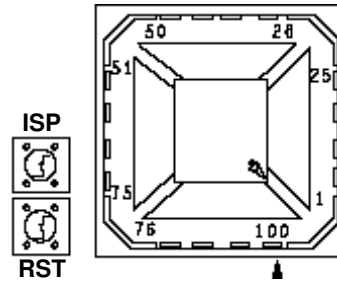

- 2.3.1 Socket** For development purpose, a ZIF socket may be soldered in place of the AT85C51SND3Bx chip.
- 2.3.2 Reset** By pressing the RST push-button, a warm RESET of the AT85C51SND3Bx is performed.
- 2.3.3 In System Programming** Pressing the ISP push-button while releasing the RST bush button enters the in system programming boot loader.  
Note: The AT85C51SND3Bx embeds a generic Nand Flash boot-loader.

**2.4 Remote Control Unit** The Remote Control unit is split in two different units: the Serial Remote Control Unit and the Parallel Remote Control Unit.

- 2.4.1 Serial Remote Unit** The Serial Remote Control unit implements a 6-pin connector J23 sharing the UART and high-speed SPI Interfaces. This connector allows easy connection with a host able to control the audio player remotely.  
Note: The AT85DVK-07 Board is supplied without any RS-232 driver/receiver.

**Figure 2-8.** Serial Remote Control Unit Implementation

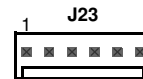
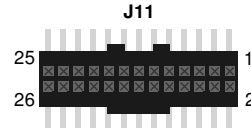

**Table 2-8.** Remote Control Connector (J23)

Pin Number	Pin Name	Pin Description
1	VDD	IOVDD power supply 1.8V or 3V depending on the power configuration
2	P3.0/RXD/MISO	UART Receive Serial Data SPI Master Input Slave Output Data Line
3	P3.1/TXD/MOSI	UART Transmit Serial Data SPI Master Output Slave Input Data Line
4	P3.2/ $\overline{\text{INT0}}$ / $\overline{\text{RTS}}$ / $\overline{\text{SCK}}$	UART Request To Send Control Line SPI Clock Line
5	P3.3/ $\overline{\text{INT1}}$ / $\overline{\text{CTS}}$ / $\overline{\text{SS}}$	UART Clear To Send Control Line SPI Slave Select Line
6	VSS	0V digital supply reference

- 2.4.2 Parallel Remote Unit** The Parallel Remote Control unit implements a 26-pin connector J11 sharing the PSI (8-bit Parallel Slave Interface) UART and high-speed SPI Interfaces. This connector allows easy connection with a host able to control the audio player remotely.  
Note: The Parallel Slave Interface and Display Interface are sharing same signals. So on board LCD must then be disconnected by removing its flat cable from J34 socket.



**Figure 2-9.** Parallel Remote Control Unit Implementation**Table 2-9.** Remote Control Connector (J11)

Pin Number	Pin Name	Pin Description
1	VDD	IOVDD power supply 1.8V or 3V depending on the power configuration
2	BLVDD	Controlled HVDD for back-light usage (LCD extension)
3	P3.0/RXD/MISO	UART Receive Serial Data SPI Master Input Slave Output Data Line
4	P1.7	General purpose I/O or back-light control (LCD extension)
5	P3.1/TXD/MOSI	UART Transmit Serial Data SPI Master Output Slave Input Data Line
6	$\overline{\text{nRST}}$	Chip Reset (optional through SE30 solder strap)
7	P3.2/ $\overline{\text{INT0}}$ / $\overline{\text{RTS}}$ / $\overline{\text{SCK}}$	External Interrupt 0 UART Request To Send Control Line SPI Clock Line
8	P5.1/ $\overline{\text{SCS}}$ / $\overline{\text{LCS}}$	PSI Slave Chip Select LCD Chip Select
9	P3.3/ $\overline{\text{INT1}}$ / $\overline{\text{CTS}}$ / $\overline{\text{SS}}$	External Interrupt 1 UART Clear To Send Control Line SPI Slave Select Line
10	P5.2/ $\overline{\text{SA0}}$ / $\overline{\text{LA0}}$ / $\overline{\text{LRS}}$	PSI Slave Address Bit 0 LCD Address Bit 0 (8080) Register Select Signal (6800)
11	VSS	0V digital supply reference
12	P5.3/ $\overline{\text{SWR}}$ / $\overline{\text{LWR}}$ / $\overline{\text{LRW}}$	PSI Slave Write Signal LCD Write Signal (8080) Read/Write Signal (6800)
13	VSS	0V digital supply reference
14	P5.0/ $\overline{\text{SRD}}$ / $\overline{\text{LRD}}$ / $\overline{\text{LDE}}$	PSI Slave Write Signal LCD Read Signal (8080) Enable Signal (6800)
15	VSS	0V digital supply reference
16	P0.0/ $\overline{\text{SD0}}$ / $\overline{\text{LD0}}$	PSI Slave Data Bit 0 LCD Data Bit 0
17	VSS	0V digital supply reference
18	P0.1/ $\overline{\text{SD1}}$ / $\overline{\text{LD1}}$	PSI Slave Data Bit 1 LCD Data Bit 1
19	VSS	0V digital supply reference
20	P0.2/ $\overline{\text{SD2}}$ / $\overline{\text{LD2}}$	PSI Slave Data Bit 2 LCD Data Bit 2
21	VSS	0V digital supply reference
22	P0.3/ $\overline{\text{SD3}}$ / $\overline{\text{LD3}}$	PSI Slave Data Bit 3 LCD Data Bit 3
23	P0.5/ $\overline{\text{SD5}}$ / $\overline{\text{LD5}}$	PSI Slave Data Bit 5 LCD Data Bit 5

Pin Number	Pin Name	Pin Description
24	P0.4/SD4/LD4	PSI Slave Data Bit 4 LCD Data Bit 4
25	P0.7/SD7/LD7	PSI Slave Data Bit 7 LCD Data Bit 7
26	P0.6/SD6/LD6	PSI Slave Data Bit 6 LCD Data Bit 6

## 2.5 USB Unit

The USB unit provides all the required hardware to develop USB V2.0 full-speed and high-speed devices and full-speed reduced-host / OTG compliant applications. It consists in a USB mini AB connector (including ID pin) and an OTG extension connector J24 (see Table 2-10) which allows control of an external VBUS power supply able to power USB device.

Details on how to connect a USB storage device to the AT85DVK-07 Board are provided in Section 2.15.

**Figure 2-10.** USB Unit Implementation



### 2.5.1 OTG Extension

**Table 2-10.** OTG Extension Connector (J24)

Pin Number	Pin Name	Pin Description
1	UVCON	External VBUS ON/OFF control line
2	VBUS	+5V VBUS from external power supply
3	VSS	0V digital supply reference

## 2.6 Nand Flash Unit

The Nand Flash unit consists in a standard nand flash memory foot print allowing user to solder its own nand flash memory and 2 extension connectors J13 & J14 allowing insertion of a 2x NF daughter board or a 4x NF daughter board supporting up to 2 or 4 nand flash memories.

A 4x nand flash daughter board equipped with 1 memory along with a bare PCB (see Section 2.16) is delivered inside the AT85DVK-07 Starter Kit. Figure 2-12 shows the daughter-board plug-in orientation.

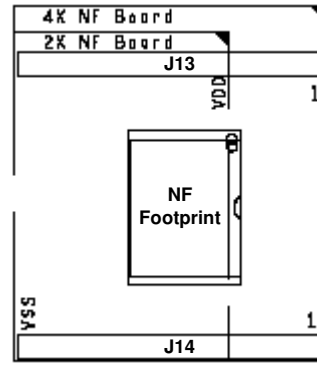
**Figure 2-11.** Nand Flash Unit Implementation

### 2.6.1 Nand Flash Extension

**Table 2-11.** Nand Flash Daughter Board Extension Connector (J13)

Pin Number	Pin Name	Pin Description
1	$\overline{\text{NFWP}}$	Write Protect Signal
2	$\overline{\text{NFCE3}}$ $\overline{\text{SMCE}}$	Nand Flash 3 Chip Enable SmartMediaCard/xD-Picture Card Chip Enable
3	$\overline{\text{NFCE2}}$ $\overline{\text{SMINS}}$	Nand Flash 2 Chip Enable SmartMediaCard/xD-Picture Card Insertion Signal
4	$\overline{\text{NFWP}}$	Write Protect Signal
5	VDD	IOVDD power supply 1.8V or 3V depending on the power configuration
6	NFCLE	Command Latch Enable Signal
7	NFALE	Address Latch Enable Signal
8	NC	Not Used
9	$\overline{\text{NFCE0}}$	Nand Flash 0 Chip Enable
10	NC	Not Used
11	$\overline{\text{NFCE1}}$ $\overline{\text{SMLCK}}$	Nand Flash 1 Chip Enable SmartMediaCard/xD-Picture Card Write Lock Signal
12	$\overline{\text{NFRE}}$	Read Enable Signal
13	$\overline{\text{NFWE}}$	Write Enable Signal

**Table 2-12.** Nand Flash Daughter Board Extension Connector (J14)

Pin Number	Pin Name	Pin Description
1	$\overline{\text{NFWP}}$	Write Protect Signal
2	NC	Not Used
3	NC	Not Used
4	$\overline{\text{NFWP}}$	Write Protect Signal
5	NFD7	Data Bit 7
6	NFD6	Data Bit 6
7	NFD5	Data Bit 5
8	NFD4	Data Bit 4
9	NFD3	Data Bit 3
10	NFD2	Data Bit 2

Pin Number	Pin Name	Pin Description
11	NFD1	Data Bit 1
12	NFD0	Data Bit 0
13	VSS	0V digital supply reference

**Figure 2-12.** Nand Flash Daughter Board Plug-In

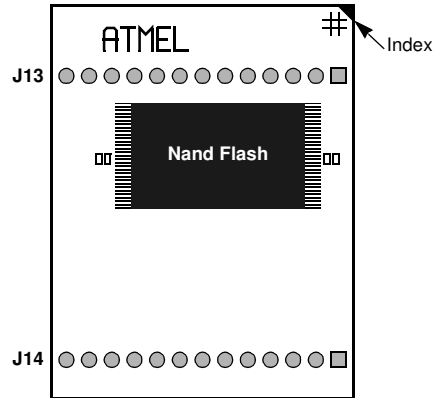

**2.6.2 On-Board Nand Flash Configuration**

In case nand flash memory is soldered on board (user’s responsibility) a hardware configuration must be applied (see Figure 2-13) to avoid any conflict with a nand flash daughter board that may be plugged-in. When no nand flash memory is soldered solder straps may be left opened.

**Figure 2-13.** Nand Flash Configuration (bottom view)

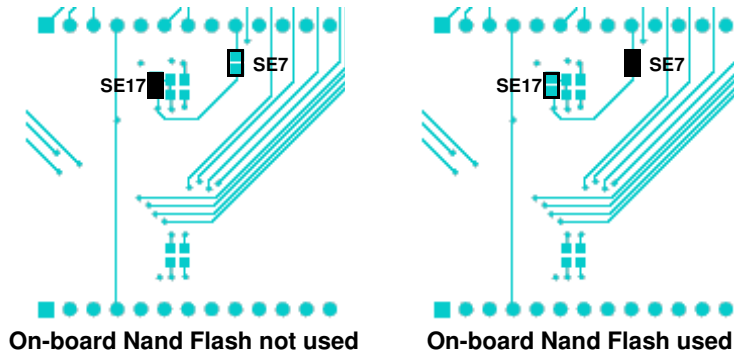

**2.7 MMC/SD Unit**

The MMC/SD unit consists in a single card socket that allows direct plug-in of MMC, RS-MMC and SD cards.

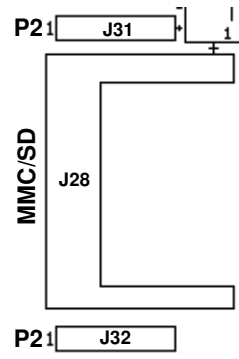

**Figure 2-14.** MMC/SD Unit Implementation

### 2.7.1 MMC I/O Extension

Two extension connectors J31 and J32 (see Table 2-13 and Table 2-14) are implemented to get an access to the P2 alternate I/Os in case MMC is not used, or to plug an other socket (e.g. Mini-SD) through a daughter board.

**Table 2-13.** MMC/SD I/O Extension Connector (J31)

Pin Number	Pin Name	Pin Description
1	P2.0/ $\overline{\text{SDINS}}$	SD/MMC Card Insertion Signal
2	P2.1/ $\overline{\text{SDLCK}}$	SD Card Write Lock Signal
3	P2.2/ $\overline{\text{SDCMD}}$	SD/MMC Command Line
4	P2.3/ $\overline{\text{SDCLK}}$	SD/MMC Clock
5	P2.4/ $\overline{\text{SDDAT0}}$	SD/MMC Data Line 0

**Table 2-14.** MMC/SD I/O Extension Connector (J32)

Pin Number	Pin Name	Pin Description
1	P2.5/ $\overline{\text{SDDAT1}}$	SD/MMC Data Line 1
2	P2.6/ $\overline{\text{SDDAT2}}$	SD/MMC Data Line 2
3	P2.7/ $\overline{\text{SDDAT3}}$	SD/MMC Data Line 3
4	VDD	IOVDD power supply 1.8V or 3V depending on the power configuration
5	VSS	0V digital supply reference

## 2.8 Audio Input Unit

The Audio Input unit consists in the electret microphone unit and a 3.5mm stereo input jack J3.

**Figure 2-15.** Audio Input Unit Implementation

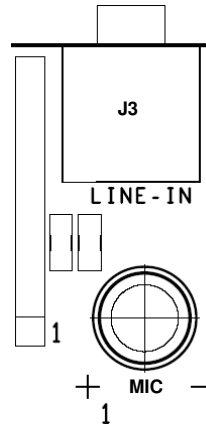

## 2.9 Audio Output Unit

The Audio Output unit consists in 2 stereo 3.5 mm jacks J7 & J8 allowing output selection between on-chip audio codec (with its optional on-board headphone amplifier) and on-board audio DAC. Moreover 2 extension connectors J5 and J9 (see Table 2-15 and Table 2-16) allow user to plug daughter boards replacing on-board headphone amplifier or on-board audio DAC. In this case, solder straps SE1, SE2, SE19, SE18, SE51 for external headphone amplifier and SE49, SE50 for external audio DAC must be left opened to avoid short circuits.

Note: On-board DAC and on-chip DAC (audio codec) usage is exclusive. User's selection can be configured in the audio firmware driver (for further information, refer to the firmware user's manual).

**Figure 2-16.** Audio Output Unit Implementation

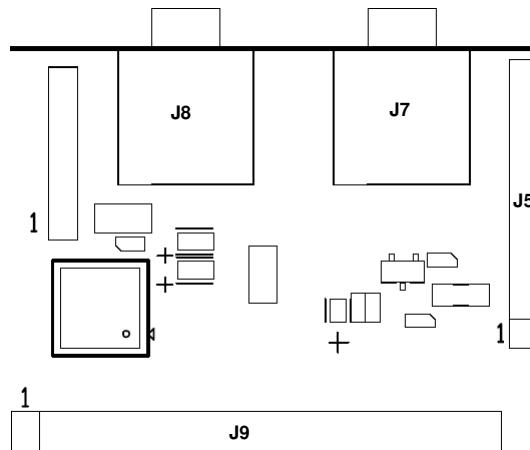

**Table 2-15.** Headphone Amplifier Extension Connector (J5)

Pin Number	Pin Name	Pin Description
1	LVDD	Very Low Voltage VDD power supply 1.8V
2	$\overline{\text{AMP\_EN}}$	Active low amplifier enable signal
3	AMP_IR	Amplifier left channel analog input
4	AMP_IC	Common reference analog input
5	AMP_IL	Amplifier right channel analog input
6	AMP_OR	Amplifier left channel output

Pin Number	Pin Name	Pin Description
7	AMP_OC	Common reference amplifier output
8	AMP_OL	Amplifier right channel output
9	AVSS	0V analog supply reference
10	NC	

**Table 2-16.** Audio DAC Extension Connector (J9)

Pin Number	Pin Name	Pin Description
1	VDD	IOVDD power supply 1.8V or 3V depending on the power configuration
2	DAC_I0	DAC control bit 0
3	DAC_I1	DAC control bit 1
4	DAC_I2	DAC control bit 2
5	DAC_I3	DAC control bit 3
6	$\overline{\text{DAC\_nRST}}$	Active low DAC reset signal
7	DAC_OCLK	DAC oversampling clock
8	DAC_DCLK	DAC data clock
9	DAC_DDAT	DAC data line
10	DAC_DSEL	DAC channel select line
11	VSS	0V digital supply reference
12	VSS	0V digital supply reference
13	DAC_OR	DAC left channel output
14	DAC_OC	Common reference DAC output
15	DAC_OL	DAC right channel output
16	AVSS	0V analog supply reference
17	AVSS	0V analog supply reference

### 2.9.1 Headphone Amp Configuration

In very-low voltage application, the on-chip headphone amplifier is not able to drive the headphone. In this case an external amplifier must be configured as detailed in Figure 2-17.

Note: On-board or on-chip headphone amplifier option must also be configured by user in the audio firmware driver (for further information, refer to the firmware user's manual).

**Figure 2-17.** Headphone Amplifier Configuration (bottom view)

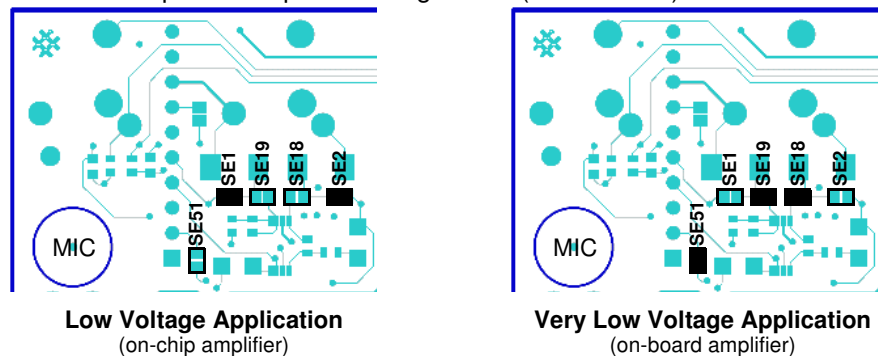

## 2.10 FM Receiver Unit

The FM unit consists in 2 extension connectors J1 & J2 (see Table 2-17 and Table 2-18) allowing user to plug a daughter board featuring a FM receiver.

Note: Using P4.3:0 I/O port to control the FM receiver chip implies that the on-board DAC can not be used in this configuration.

**Table 2-17.** FM Receiver Extension Connector (J1)

Pin Number	Pin Name	Pin Description
1	VDD	IOVDD power supply 1.8V or 3V depending on the power configuration
2	LINL	Left channel analog input
3	LINC	Common reference analog input
4	LINR	Right channel analog input
5	AVSS	0V analog supply reference
6	AVSS	0V analog supply reference

**Table 2-18.** FM Receiver Extension Connector (J2)

Pin Number	Pin Name	Pin Description
1	VDD	IOVDD power supply 1.8V or 3V depending on the power configuration
2	P4.0/OCLK	FM receiver control bit 0
3	P4.1/DCLK	FM receiver control bit 1
4	P4.2/DDAT	FM receiver control bit 2
5	P4.3/DSEL	FM receiver control bit 3
6	VSS	0V digital supply reference

## 2.11 Display Unit

The Display unit consists in a 128x64 monochrome pixels LCD. It is possible to plug a daughter board equipped with an other LCD (color, higher resolution...) using J11 connector (see Section 2.4.2).

Note: On-board LCD must be disconnected before plugging any daughter boards.

## 2.12 Keypad Unit

The Keypad unit consists in a 3 x 4 key matrix including a 4-direction mini joystick and power-on key along with 2 extension connectors. J10 & J30 allow user to plug a daughter board featuring particular keys like 2-direction mini joystick, rolling wheel...

Note: To ease software implementation with generic software keypad driver, user's keypad arrangement must fit with an available matrix configuration (for further information, refer to the firmware user's manual).

**Figure 2-18.** Keypad Unit Implementation

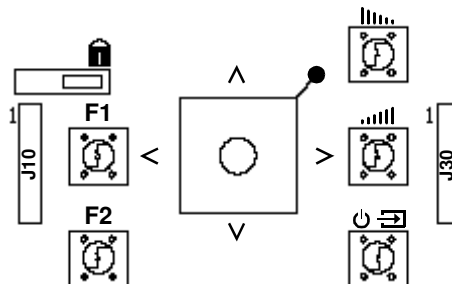

## 2.12.1 Keypad Extension

**Table 2-19.** Keypad Extension Connector (J10)

Pin Number	Pin Name	Pin Description
1	VDD	IOVDD power supply 1.8V or 3V depending on the power configuration
2	P1.4	General purpose I/O used for matrix row
3	P1.3/KIN3	General purpose I/O used for matrix row or matrix column 3 input <sup>(1)</sup>
4	P1.2/KIN2	General purpose I/O used for matrix row or matrix column 2 input <sup>(1)</sup>
5	P1.5	General purpose I/O used for matrix row

**Table 2-20.** Keypad Extension Connector (J30)

Pin Number	Pin Name	Pin Description
1	P1.0/KIN0	Matrix column 0 input
2	P1.1/KIN1	Matrix column 1 input
3	P1.6 <sup>(2)</sup>	General purpose I/O
4	P1.7 <sup>(3)</sup>	General purpose I/O
5	VSS	0V digital supply reference

- Notes:
1. Depends on matrix configuration.
  2. P1.6 is also used as external headphone amplifier enable signal and so may only be available when not used for such purpose.
  3. P1.7 is also used as LCD backlight control signal and so may only be available when not used for such purpose.

## 2.13 On-Chip Debug Unit

The On-Chip Debug (OCD) unit consists in a 10-pin or 6-pin connector J26 allowing connection of the OCD dongle V1 or V2 through a flat cable. This dongle is part of the development kit and allows debugging of the firmware using Keil's Integrated Development Environment.

**Table 2-21.** 10-pin OCD Connector (J26)

Pin Number	Pin Name	Pin Description	Pin Number	Pin Name	Pin Description
1	NC		2	NC	
3	VSS	0V digital supply reference	4 <sup>(1)</sup>	OCDT	OCD Transmit signal
5 <sup>(1)</sup>	$\overline{\text{RST}}$	MCU Reset signal	6 <sup>(1)</sup>	OCDR	OCD Receive signal
7	VSS	0V digital supply reference	8 <sup>(1)</sup>	VSS	0V digital supply reference
9	VSS	0V digital supply reference	10 <sup>(1)</sup>	$\overline{\text{RST}}$	MCU Reset signal

- Note:
1. Mandatory signals to implement on user's development board. Signal to connect to the OCD dongle for debugging.

**Table 2-22.** 6-pin OCD Connector (J26)

Pin Number	Pin Name	Pin Description	Pin Number	Pin Name	Pin Description
1	NC		2	NC	
3	VSS	0V digital supply reference	4	OCDT	OCD Transmit signal
5	$\overline{\text{RST}}$	MCU Reset signal	6	OCDR	OCD Receive signal

## 2.14 Power Consumption Measurement

In order to ease the power supply measurement, 4 jumpers are implemented as detailed in Figure 2-19:

**Figure 2-19.** Power Management Unit Implementation

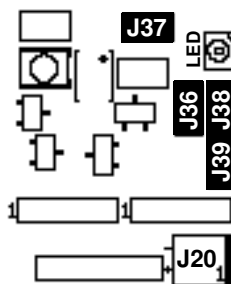

- J37
    - This jumper allows insertion of a ammeter on VBUS power supply.
    - Mass storage power consumption can be monitored using this jumper.
  - J36
    - This jumper allows insertion of a ammeter on AT85C51SND3Bx HV<sub>DD</sub> power supply.
    - The AT85C51SND3Bx HI<sub>DD</sub> power consumption can be monitored using this jumper.
  - J38
    - This jumper allows insertion of a ammeter on AT85C51SND3Bx LV<sub>DD</sub> power supply.
    - The AT85C51SND3Bx LI<sub>DD</sub> power consumption can be monitored using this jumper.
  - J39
    - This jumper allows insertion of a ammeter on board V<sub>DD</sub> power supply (LV<sub>DD</sub> or HV<sub>DD</sub> depending on power configuration).
    - The NF, MMC, LCD... power consumption can be monitored using this jumper.
- Note: In order to remove non significant consumption linked to the led power supply (HV<sub>DD</sub>), remove SE31 solder strap.

## 2.15 USB Storage Device Connection

A USB storage device can be connected to the AT85DVK-07 Board using the “Mini A to Receptacle A USB cable” as shown in Figure 2-20.

In order to power the USB storage device, an external 5V controlled VBUS power supply must be connected to J24 (see Table 2-10) according to Figure 2-21.

The VBUS power supply is controlled by the active-low UVCON signal.

**Figure 2-20.** USB Mass Storage Device Connection

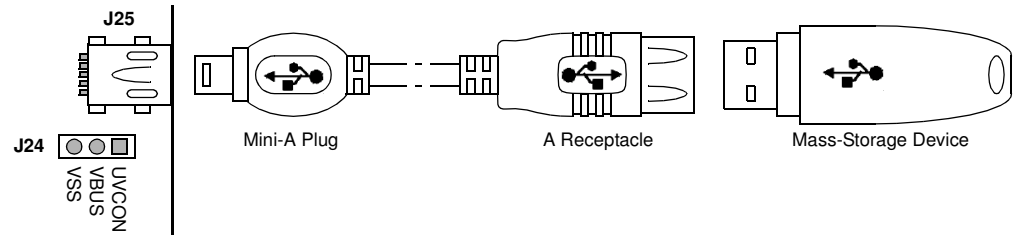

**Figure 2-21.** USB Device Power Supply Connection

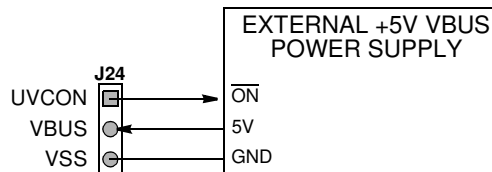

## 2.16 Nand Flash Board Extension

The Nand Flash bare PCB is delivered to make easy new Nand Flash testing.

The AT85C51SND3Bx Nand Flash drivers support up to 4 nand flash with 1x, 2x or 4x configuration. The Nand Flash extension board can be configured for operation with single CE or double CE Nand Flash memories (double dies per package).

Figure 2-22 shows the board implementation while Table 2-23 and Table 2-24 summarize the board configuration depending on Nand Flash memory type.

Note: In order to fit with generic software driver, the Nand Flash memories soldered on one board must be of same part number.

**Figure 2-22.** Nand Flash Board Implementation

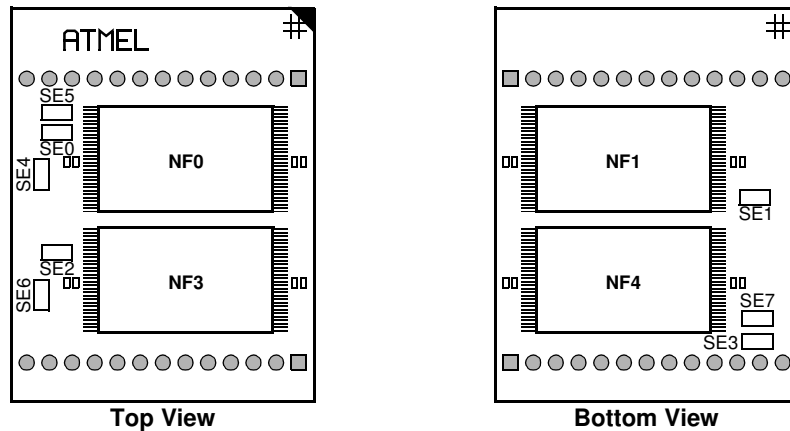

**Table 2-23.** Single  $\overline{\text{CE}}$  Nand Flash Memory Configuration

Number of NF	Populated Footprint				Solder Strap Configuration							
	NF0	NF1	NF2	NF3	SE0 <sup>(1)</sup>	SE1 <sup>(1)</sup>	SE2 <sup>(1)</sup>	SE3 <sup>(1)</sup>	SE4	SE5	SE6	SE7
x1	X				X							
x2	X	X			X	X						
x4	X	X	X	X	X	X	X	X				

Note: 1. Optional configuration depending on Nand Flash Manufacturer. These solder straps connect pin 6 (TSOP package) of selected NF to VSS (check Nand Flash datasheet).

**Table 2-24.** Double  $\overline{\text{CE}}$  Nand Flash Memory Configuration

Number of NF	Populated Footprint				Solder Strap Configuration							
	NF0	NF1	NF2	NF3	SE0	SE1	SE2	SE3	SE4	SE5	SE6	SE7
x1	X								X	X		
x2	X		X						X	X	X	X





## Section 3

---

# Technical Specifications

### ■ System Unit

- Physical Dimensions    L= 120 x W= 120 x H= 25 mm
- Weight                    100 g

### ■ Operating Conditions

- Voltage Supply  
1.5V single battery element or USB  $V_{BUS}$  or external power supply (battery replacement)



## Section 4

---

# Development Board Errata List

---

### 4.1 Board V1.0.0

- **On-Board 3V DC-DC - Bad Startup**  
DC-DC is not properly maintained after power-up.  
**Workaround:**  
Do not use external DC-DC: power the board using USB cable.
- **Microphone Input - DC Decoupling**  
The decoupling capacitor is missing between microphone and MICIN input.  
**Workaround:**  
Add 1uF capacitor between microphone and MICIN input (layout cut).
- **External DAC - Conflict Using SPI/SIO Interface**  
External DAC being controlled by the SPI/SIO lines, SPI or SIO transfers are disturbed by the SPI\_DOUT line when SPI\_CSB line is asserted.  
**Workaround:**  
Insulate SPI DAC control lines (layout cut).
- **LCD - Display Stability @ 1.8V**  
The display shows flickering when operating @ 1.8V (LCD charge pump issue).  
**Workaround:**  
None.

---

### 4.2 Board V1.0.1

- **LCD - Display Stability @ 1.8V**  
The display shows flickering when operating @ 1.8V (LCD charge pump issue).  
**Workaround:**  
None.



## Section 5

# Technical Support

There are two ways to report a technical issue:

- Through E-mail at [mcu@atmel.com](mailto:mcu@atmel.com)
- Through web site at <http://support.atmel.no/bin/customer>

When requesting technical support, please report the following information:

---

### 5.1 Problem Reporting

- Object:
  - Company Name
  - Product Name
  - Short Description

Example: COMPANY – AT85C51SND3B2 – Audio File Stop Playing

Note: For follow-up reason, report problems separately i.e. one problem per report.

- Problem Description
  - Give a detailed description of your problem

---

### 5.2 Firmware

- Send your complete firmware project unless it is strictly confidential
- Package
  - Base Name: e.g. snd3b-refd1-1\_0\_33
  - Any useful information about changes...

---

### 5.3 Hardware

- Silicon
  - Part Number: e.g. 85C51SND3B1-EL
  - Date Code: e.g. 0441
  - Lot Number: e.g. A04319B
- Memories
  - NF Part Number: e.g. Micron MT29F2G08AABWG,
  - Device Number: e.g. #2

- MMC/SD Ref: e.g. Sandisk 256MB
- File System: e.g. FAT32

Note: In order to be able to reproduce and investigate the problem in our laboratory, be ready to send memory samples if any.

■ Board

- Version: e.g. V1.0.1
- Oscillator Frequency: e.g. 12 MHz
- Voltage configuration: e.g. On board DC-DC
- Operating Voltage: e.g. 3V

Any useful information about configuration

Note: In order to be able to reproduce and investigate the problem in our laboratory, be ready to send to send schematic, bread board...

■ Host

- Operating System e.g. WIN 2000
- Version/build e.g. Service Pack 4

---

## 5.4 Tools

■ OCD

- Dongle Firmware Version

■ KEIL

- Add “about” windows screen-shot in attachment

■ ISP

- Software “music\_player\_isp.exe” version

---

## 5.5 Audio Player

Send any audio files that fail.

---

## 5.6 Picture Viewer

Send any picture files that fail.



## Atmel Corporation

2325 Orchard Parkway  
San Jose, CA 95131  
Tel: 1(408) 441-0311  
Fax: 1(408) 487-2600

## Regional Headquarters

### Europe

Atmel Sarl  
Route des Arsenalux 41  
Case Postale 80  
CH-1705 Fribourg  
Switzerland  
Tel: (41) 26-426-5555  
Fax: (41) 26-426-5500

### Asia

Room 1219  
Chinachem Golden Plaza  
77 Mody Road Tsimshatsui  
East Kowloon  
Hong Kong  
Tel: (852) 2721-9778  
Fax: (852) 2722-1369

### Japan

9F, Tonetsu Shinkawa Bldg.  
1-24-8 Shinkawa  
Chuo-ku, Tokyo 104-0033  
Japan  
Tel: (81) 3-3523-3551  
Fax: (81) 3-3523-7581

## Atmel Operations

### Memory

2325 Orchard Parkway  
San Jose, CA 95131  
Tel: 1(408) 441-0311  
Fax: 1(408) 436-4314

### Microcontrollers

2325 Orchard Parkway  
San Jose, CA 95131  
Tel: 1(408) 441-0311  
Fax: 1(408) 436-4314

La Chantrerie  
BP 70602  
44306 Nantes Cedex 3, France  
Tel: (33) 2-40-18-18-18  
Fax: (33) 2-40-18-19-60

### ASIC/ASSP/Smart Cards

Zone Industrielle  
13106 Rousset Cedex, France  
Tel: (33) 4-42-53-60-00  
Fax: (33) 4-42-53-60-01

1150 East Cheyenne Mtn. Blvd.  
Colorado Springs, CO 80906  
Tel: 1(719) 576-3300  
Fax: 1(719) 540-1759

Scottish Enterprise Technology Park  
Maxwell Building  
East Kilbride G75 0QR, Scotland  
Tel: (44) 1355-803-000  
Fax: (44) 1355-242-743

### RF/Automotive

Theresienstrasse 2  
Postfach 3535  
74025 Heilbronn, Germany  
Tel: (49) 71-31-67-0  
Fax: (49) 71-31-67-2340

1150 East Cheyenne Mtn. Blvd.  
Colorado Springs, CO 80906  
Tel: 1(719) 576-3300  
Fax: 1(719) 540-1759

### Biometrics/Imaging/Hi-Rel MPU/ High Speed Converters/RF Datacom

Avenue de Rochepleine  
BP 123  
38521 Saint-Egreve Cedex, France  
Tel: (33) 4-76-58-30-00  
Fax: (33) 4-76-58-34-80

---

### *e-mail*

[literature@atmel.com](mailto:literature@atmel.com)

### *Web Site*

<http://www.atmel.com>

**Disclaimer:** The information in this document is provided in connection with Atmel products. No license, express or implied, by estoppel or otherwise, to any intellectual property right is granted by this document or in connection with the sale of Atmel products. **EXCEPT AS SET FORTH IN ATMEL'S TERMS AND CONDITIONS OF SALE LOCATED ON ATMEL'S WEB SITE, ATMEL ASSUMES NO LIABILITY WHATSOEVER AND DISCLAIMS ANY EXPRESS, IMPLIED OR STATUTORY WARRANTY RELATING TO ITS PRODUCTS INCLUDING, BUT NOT LIMITED TO, THE IMPLIED WARRANTY OF MERCHANTABILITY, FITNESS FOR A PARTICULAR PURPOSE, OR NON-INFRINGEMENT. IN NO EVENT SHALL ATMEL BE LIABLE FOR ANY DIRECT, INDIRECT, CONSEQUENTIAL, PUNITIVE, SPECIAL OR INCIDENTAL DAMAGES (INCLUDING, WITHOUT LIMITATION, DAMAGES FOR LOSS OF PROFITS, BUSINESS INTERRUPTION, OR LOSS OF INFORMATION) ARISING OUT OF THE USE OR INABILITY TO USE THIS DOCUMENT, EVEN IF ATMEL HAS BEEN ADVISED OF THE POSSIBILITY OF SUCH DAMAGES.** Atmel makes no representations or warranties with respect to the accuracy or completeness of the contents of this document and reserves the right to make changes to specifications and product descriptions at any time without notice. Atmel does not make any commitment to update the information contained herein. Unless specifically provided otherwise, Atmel products are not suitable for, and shall not be used in, automotive applications. Atmel's products are not intended, authorized, or warranted for use as components in applications intended to support or sustain life.

©2007 Atmel Corporation. All rights reserved. Atmel®, logo and combinations thereof, are registered trademarks, are the trademarks of Atmel Corporation or its subsidiaries. Other terms and product names may be trademarks of others.



Printed on recycled paper.