

AIRPAX®

IAR/IUR/IER/CUR/CER Series "1RU" Magnetic Circuit Protectors

IAR/IUR/IER/CUR/CER [1RU]



| | | |
|---------------------------|--|----|
| Introduction | | 52 |
| Poles & Terminals | | 53 |
| Configurations | | 56 |
| Delay Curves & Specs | | 57 |
| Operating Characteristics | | 58 |
| Hardware | | 59 |
| Decision Tables | | 60 |





AIRPAX® | IAR/IUR/IER/CUR/CER Series

“1RU” Hydraulic Magnetic Circuit Protectors

FEATURES

- UL1077, TÜV, UL489A approved
- Designed to fit in a “1RU” application
- 5,000 AIC interrupt capacity (65/80VDC, 120/240VAC)
- Series or mid-trip with auxiliary switch alarm options
- Various delays including motor start
- 1 to 2 poles, multiple termination options

INTRODUCTION

The Airpax™ IAR/IUR/IER/CUR/CER series is a snap-acting hydraulic-magnetic circuit breaker / protector that combines power switching and accurate, reliable circuit protection in one aesthetically pleasing, “1RU” sized package.

Designed for rack mount applications, the IAR/IUR/IER/CUR/CER series allows efficient use of rack space without sacrificing performance via proven hydraulic-magnetic technology that provides consistent operation from -40°C to 85°C, with a circuit interrupt capacity up to 5,000 AIC at 65/80 VDC and 120/240 VAC. Available in series trip and mid-trip configurations, with auxiliary alarm switch options to provide monitoring of critical circuits.

The CER series circuit breaker provides the necessary ratings for wireless and wired applications while meeting UL489A and TÜV requirements for approval.

APPROVALS

| Ratings | Voltage | A.I.C. | Agency Approvals | Poles |
|--------------|---------------|--------|------------------------------|-------|
| 2 to 50 amps | 65 VDC | 5,000 | UL489A & C-UL | 1 |
| 2 to 50 amps | 80 VDC | 5,000 | TÜV to EN60934 | 1 |
| 2 to 50 amps | 250 VAC | 2,000 | UL1077 & TÜV to EN60934 | 1 |
| 2 to 50 amps | 80 VDC | 5,000 | UL489A & TÜV to EN60934 | 2 |
| 2 to 30 amps | 120 / 240 VAC | 5,000 | UL1077, C-UL, TÜV to EN60934 | 2 |

POLES & TERMINALS

The Airpax™ IAR/IUR/IER/CUR/CER series is available with one or two poles with various bullet, stud and screw terminals. Engineered for safe, sure operation, the toggle handles may be specified in blue, white, red, orange, green, yellow or black.

Single Pole

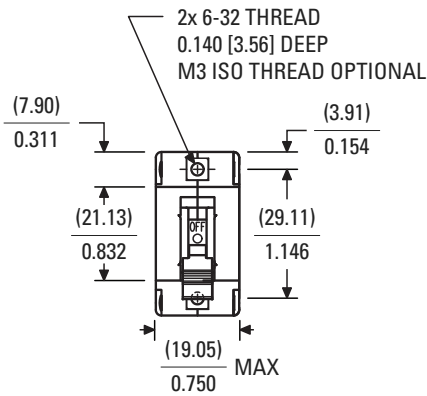

**Two Pole
(with or without two handles)**

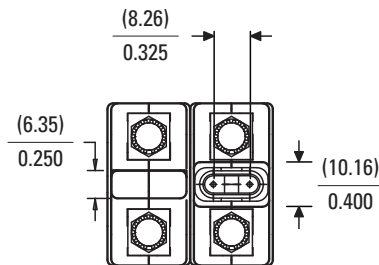
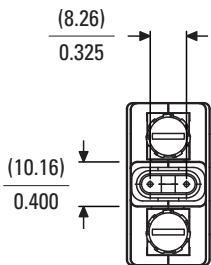
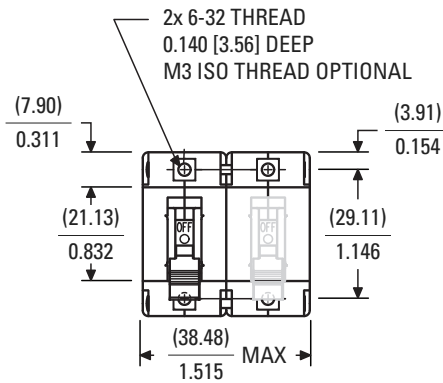

Auxiliary switch wires not shown for clarity

Panel Mounting Detail, Single Pole

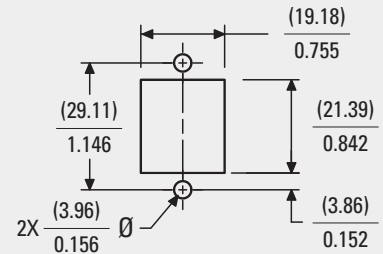

Panel Mounting Detail, Two Pole, One Handle

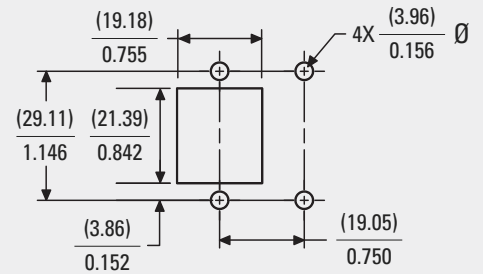

Panel Mounting Detail, Two Pole, Two Handles

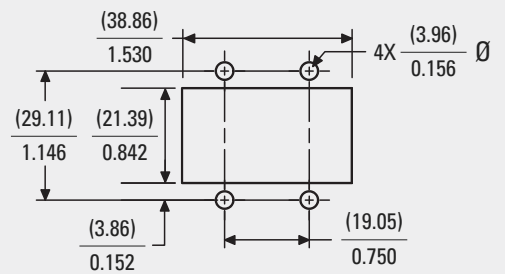

Single Pole

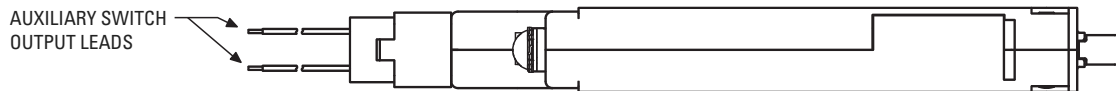

Two Pole (with or without 2nd handle)

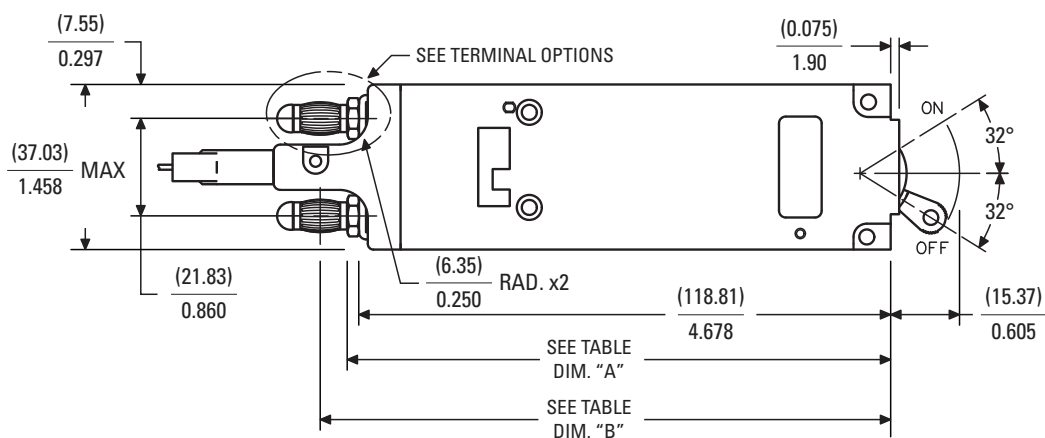
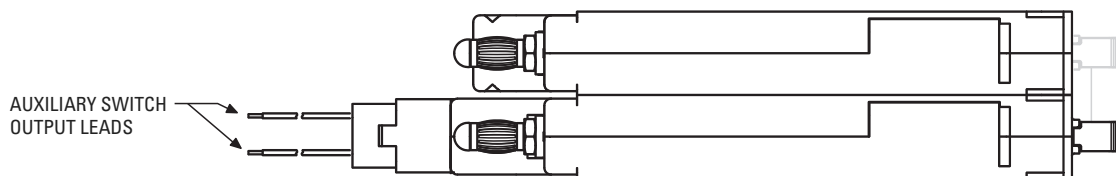

DIMENSIONS

| Bullet Type | Dim. "A" | Dim. "B" | Dim. "C" |
|--------------|-------------------|-------------------|------------------------------------|
| 1/4" Bullet | [121.35] 4.778 | [127.48] 5.019 | Ø [6.38 ± 0.03] Ø 0.251 ± 0.001 |
| 5/16" Bullet | [123.22] 4.851 | [129.35] 5.092 | Ø [7.92 ± 0.03] Ø 0.312 ± 0.001 |

| Stud Type | Dim. "E" | Dim. "F" |
|-----------|------------------|------------------|
| 10-32 | [13.84] 0.545 | [15.81] 0.622 |
| M5 | [12.95] 0.510 | [14.92] 0.588 |

**Single Pole Bullet Terminal
Mounting Detail**

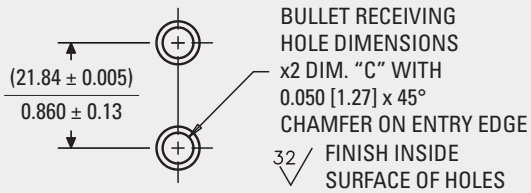

**Two Pole Bullet Terminal
Mounting Detail**

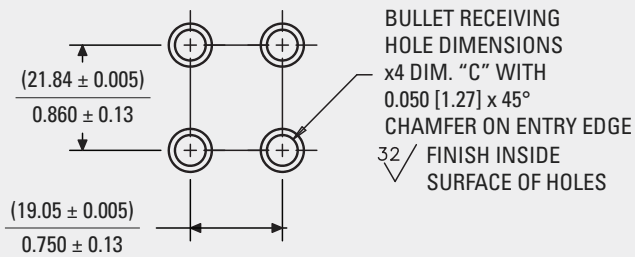

1/4" Bullet Terminals

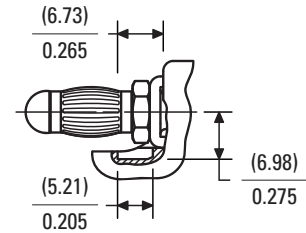

5/16" Bullet Terminals

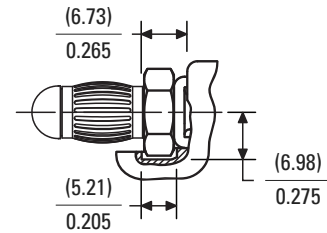

10-32 or M5 Screw Terminals

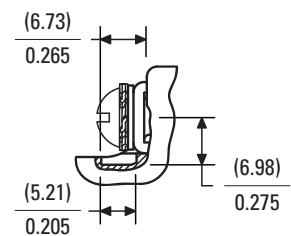

10-32 or M5 Stud Terminals

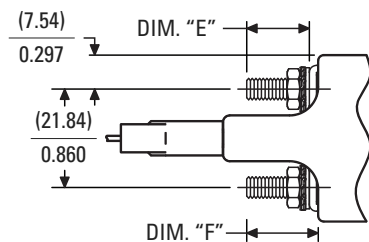

CONFIGURATIONS

Series Trip

The most popular configuration for magnetic protectors is the series trip where the sensing coil and the contacts are in series with the load being protected. In addition to providing conventional overcurrent protection, it is simultaneously used as an on-off switch.

Single Pole, Series Trip



Two Pole, Series Trip

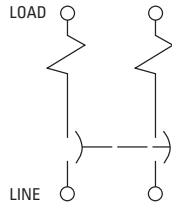

Mid-Trip

This is furnished as an integral part of a series pole in single or, multi-pole assemblies. Isolated electrically from the protector's circuit, the switch works in unison with the power contacts and provides indication at a remote location of the protector's ON-OFF status.

Mid-Trip

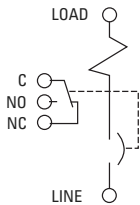

Breaker shown in ON position or manually turned OFF position

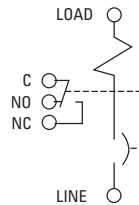

Breaker shown in mid-trip position (electrically tripped)

Auxiliary Switch

This is furnished as an integral part of a series pole in single or, multi-pole assemblies. Isolated electrically from the protector's circuit, the switch works in unison with the power contacts and provides indication at a remote location of the protector's ON-OFF status.

Auxiliary Switch

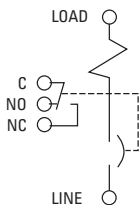

Breaker shown in OFF position

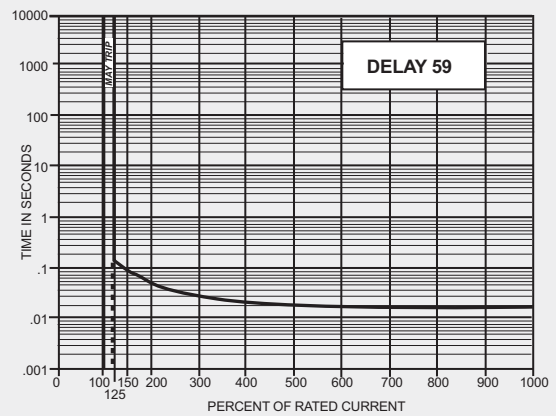
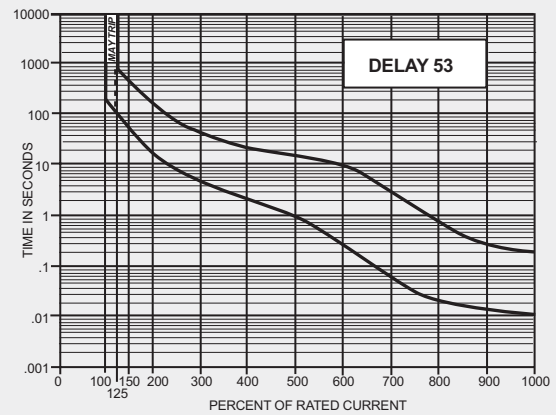
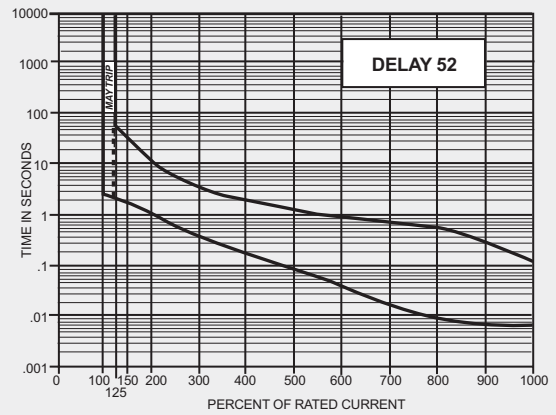
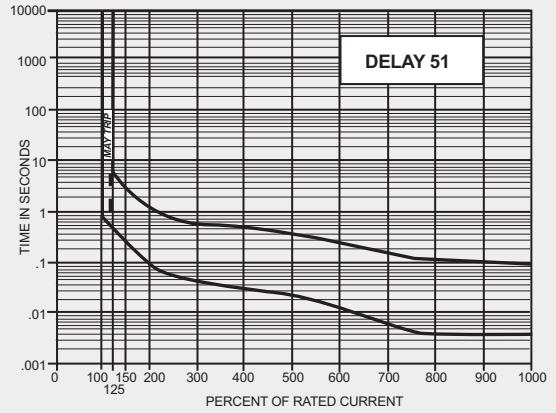

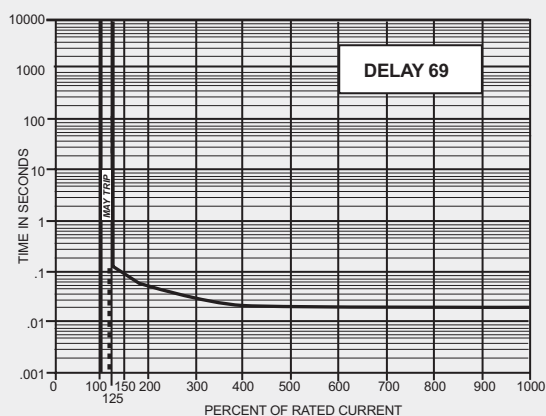
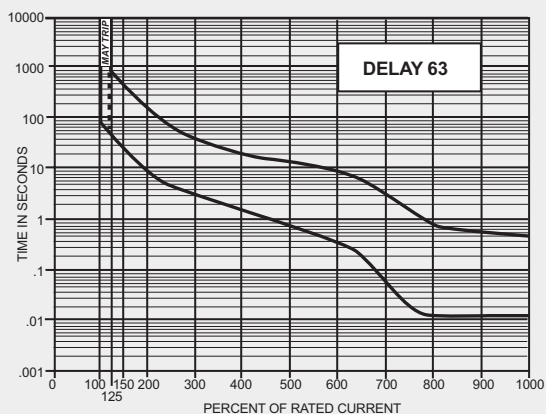
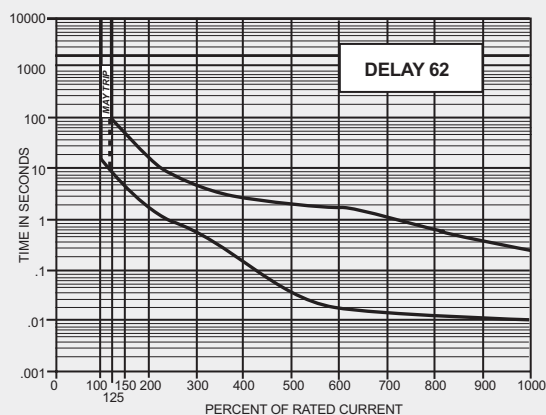
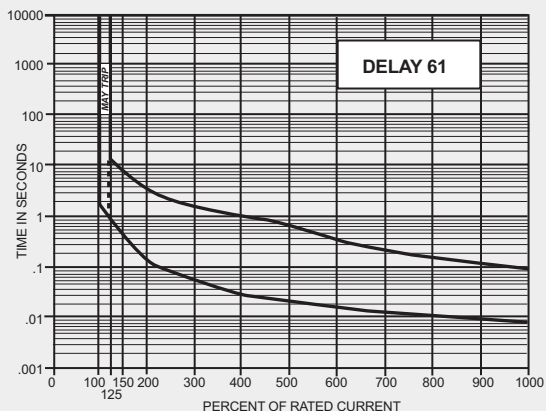

DELAY CURVES & SPECIFICATIONS

DC, 50/60Hz Delay Curves (typ)

A choice of delays is offered for DC and 50/60Hz applications. Delays 59 and 69 provide fast-acting, instantaneous trip and are often used to protect sensitive electronic equipment (not recommended where known inrush exists). Delays 51 and 61 have a short delay for general purpose applications. Delays 52 and 62 are long enough to start certain types of motors and most transformer and capacitor loads.

Trip Free

Will trip open on overload, even when forcibly held on. This prevents operator from damaging the circuit by holding handle in the ON position.

Trip Indication

The operating handle moves forcibly and positively to the OFF position on overload.

Ambient Operation

Operates normally in temperatures between -40°C and $+85^{\circ}\text{C}$.

Insulation Resistance

Not less than 100 megaohms at 500Vdc.

Dielectric Strength

Shall withstand AC voltage 60 Hz, for 60 seconds between all electrically isolated terminals as described below.

| | |
|----------------------------|---|
| Series, switch only | : 3,750 VAC |
| Auxiliary switches | : 600 VAC |
| Series w/ auxiliary switch | : 3,750 between main circuit breaker terminal and auxiliary switch terminal |

Shock

Shall not trip when tested per MIL-STD-202, method 213, test condition 1 with 100% rated current applied to delayed units, except 90% current in plane 4, (i.e. handle down). Instantaneous units shall have 80% rated current applied in all planes.

Vibration

Shall not trip when vibrated per MIL-STD-202, method 204, test condition A with 100% rated current applied to delayed units and 80% rated current to instantaneous units.

Endurance

In many applications contact wear due to the electrical load determines unit life. At maximum electrical ratings, the IAR/IUR/IER/CUR/CER can perform 10,000 operations at rated current and voltage at a maximum rate of 6 operations per minute.

OPERATING CHARACTERISTICS

Inrush Pulse Tolerance

Many circuit protector applications involve a transformer turn-on, an incandescent lamp load, or a capacitor charge from a DC source. Each of these applications has one common factor: a steep transient of very high current amplitude and short duration. This takes the form of a spike or a single pulse and is the cause of most nuisance tripping associated with magnetic circuit breakers.

The IAR/IUR/IER/CUR/CER series will withstand, without tripping, a single pulse of 8 milliseconds duration (half sine wave configuration) and peak amplitude of 10 times its rating.

MAXIMUM DCR AND IMPEDANCE (APPROXIMATE VALUES)

| Current Ratings (Amps) | DC Resistance (Ohms) 51, 52, 53, 59 | 50/60Hz Impedance (Ohms) 61, 62, 63, 69 |
|------------------------|--|--|
| 2.0 | 0.027 | 0.038 |
| 3.0 | 0.074 | 0.098 |
| 6.0 | 0.037 | 0.048 |
| 7.5 | 0.025 | 0.029 |
| 15.0 | 0.010 | 0.011 |
| 32.0 | 0.003 | 0.003 |
| 40.0 | 0.003 | 0.003 |
| 50.0 | 0.0024 | 0.0025 |

*Tolerance: 2 to 2.5 amps ±20%; 2.6 to 20 amps ± 25%; 21 to 50 amps ±50%
Consult factory for special values and for coil impedance of delays not shown

AUXILIARY SWITCH RATING

| | | |
|-----------|---|----------------|
| 10.0 amps | @ | 250 VAC, 60 Hz |
| 3.0 amps | @ | 50 VDC |
| 1.0 amps | @ | 80 VDC |

APPROXIMATE WEIGHT PER POLE

| | |
|--------|-----------|
| 1 pole | 134 grams |
| 2 pole | 263 grams |

PULSE TOLERANCE

| Delay | Pulse Tolerance |
|------------|------------------------|
| 61, 62, 63 | 10 Times Rated Current |

PERCENTAGE OF RATED CURRENT VS TRIP TIME IN SECONDS AT +25°C (APPROXIMATE VALUES)

| Delay | 100% | 125% | 150% | 200% | 400% | 600% | 800% | 1000% |
|-------|---------|------------|-----------|------------|--------------|---------------|---------------|---------------|
| 51 | No Trip | 0.5 to 6.5 | 0.3 to 3 | 0.1 to 1.2 | 0.031 to 0.5 | 0.011 to 0.25 | 0.004 to 0.1 | 0.004 to 0.08 |
| 52 | No Trip | 2 to 60 | 1.8 to 30 | 1 to 10 | 0.15 to 2 | 0.015 to 1 | 0.008 to 0.5 | 0.006 to 0.1 |
| 53 | No Trip | 80 to 700 | 40 to 400 | 15 to 150 | 2 to 20 | 0.015 to 9 | 0.015 to 0.55 | 0.012 to 0.2 |
| 59 | No Trip | 0.120 max | 0.1 max | 0.05 max | 0.022 max | 0.017 max | 0.017 max | 0.017 max |
| 61 | No Trip | 0.7 to 12 | 0.35 to 7 | 0.13 to 3 | 0.03 to 1 | 0.015 to 0.3 | 0.01 to 0.15 | 0.008 to 0.1 |
| 62 | No Trip | 10 to 120 | 6 to 60 | 2 to 20 | 0.2 to 3 | 0.015 to 2 | 0.015 to 0.8 | 0.01 to 0.25 |
| 63 | No Trip | 50 to 700 | 30 to 400 | 10 to 150 | 1.5 to 20 | 0.015 to 10 | 0.013 to 0.85 | 0.013 to 0.5 |
| 69 | No Trip | 0.12 max | 0.1 max | 0.05 max | 0.022 max | 0.017 max | 0.017 max | 0.017 max |

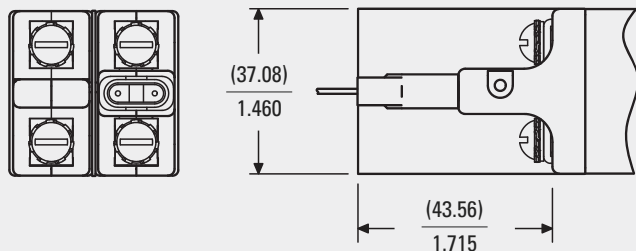
Barrier (-B)**Bullets****Socket 1/4-20 UNC-2A**

Order # 641-480-5032
(silver plated copper)

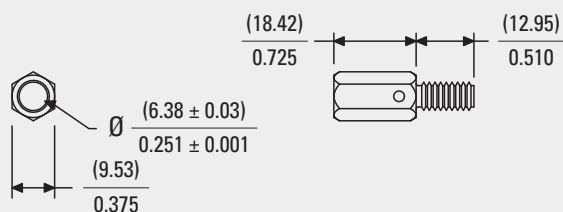
**Socket 1/4-20 UNC-2A**

Order # 641-480-5030
(silver plated copper)

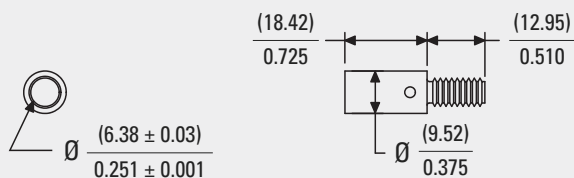
**Socket 1/4-20 UNC-2A**

Order # 641-480-5022
(silver plated copper)

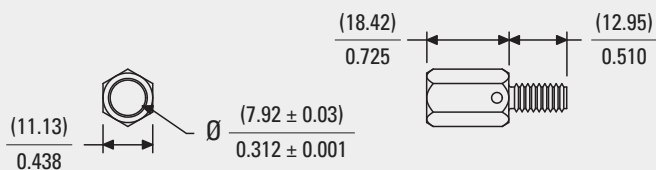
**Nut 1/4-20 UNC-2B**

Order # 388-899-5010
(silver plated copper)

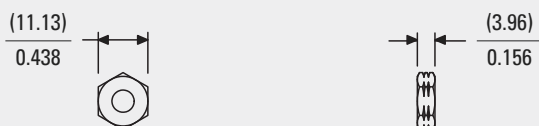
**HARDWARE****Handle Lock**

A handle lock option is available to prevent accidental actuation of the handle. The handle lock may be used in the ON or OFF position. Use of the handle lock on breakers with alarm style auxiliary switches may defeat the alarm feature on electrical trip. This option is available separately or pre-assembled (on single pole constructions only).

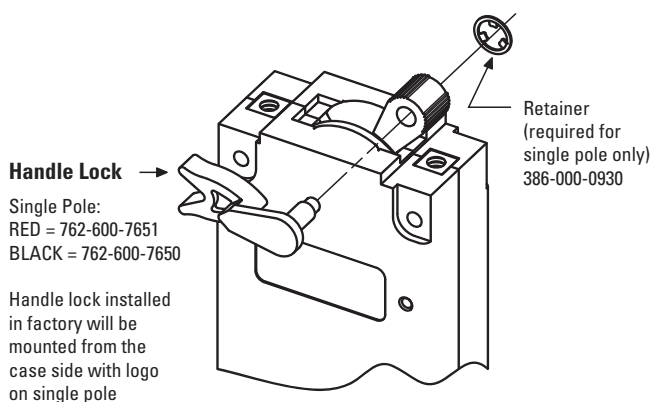
**Mid-Trip**

The handle position indicates the status of the circuit breaker. In addition to full ON and full OFF positions, there is a middle "MID-TRIP" position indicating that the breaker has electrically tripped from an overload. It is available in single pole and multi-pole (handle per pole only) series constructions. Switch only configuration is not available in mid-trip build. An auxiliary switch can be furnished as an integral part of the mid-trip breaker. The switch provides an indication at a remote location when the circuit breaker has electrically tripped and handle is in the mid-trip position.

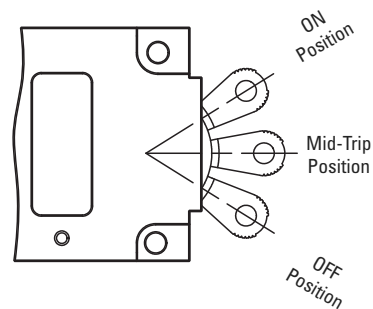

HOW TO ORDER

The ordering code for these circuit breakers / protectors may be determined by following the steps in the decision tables shown here.

The example shown is the code for a UL1077 & TÜV approved circuit protector with series trip, one handle per unit, single pole circuit protector with 10-32 terminal screws standard and a mechanical auxiliary switch. This unit is designed with a slow DC time delay and a rating of 20 amperes with optional metric threads and optional 80VDC capability. Handle color is black with white markings, and is has been met all the selection criteria to obtain the TÜV approval.

To determine the ordering code for your particular unit, simply follow the steps shown, then fill in the letters and/or numbers in the boxes. Space is available on the circuit breaker label for your part number (up to 12 digits). You may then use your own part number to place an order or as a reference for further questions you may have. This option does require a factory assigned part number for traceability to your drawing or internal part number.

| 1 | | First Choice: Type | Second Choice: Terminal |
|------|---|--------------------|---|
| IAR | Magnetic circuit protector, one handle per unit | | 10-32 screw terminal, standard (no entry) |
| IARH | Magnetic circuit protector, one handle per pole | K | 10-32 stud terminal |
| IER | UL1077 & TÜV, series trip, one handle per unit | B | 0.250" bullet terminal |
| IERH | UL1077 & TÜV, series trip, one handle per pole | | <p><i>The shaded areas denote TÜV approval options. This approval requires the addition of a "T" at the end of the part number (8th decision).</i></p> <p><i>The "T" will automatically be added to any part number formed entirely from these shaded decisions. If non-shaded areas are selected, the unit will not be TÜV approved, but other approvals (if applicable) will still apply.</i></p> |
| IUR | UL1077, series trip, one handle per unit | | |
| IURH | UL1077, series trip, one handle per pole | | |
| IMR | UL1077 & TÜV, mid trip, one handle per unit | | |
| IMRH | UL1077 & TÜV, mid trip, one handle per pole | | |
| CER | UL489A & TÜV, series trip, one handle per unit | | |
| CERH | UL489A & TÜV, series trip, one handle per pole | | |
| CUR | UL489A, series trip, one handle per unit | | |
| CURH | UL489A, series trip, one handle per pole | | |
| CMR | UL489A & TÜV, mid trip, one handle per unit | | |
| CMRH | UL489A & TÜV, mid trip, one handle per pole | | |

IER 1 - 1REC4C - 52 - 20.0 - AD - 01 - T



2

Number of Poles

| | |
|----|-------------|
| 1 | Single pole |
| 11 | Two pole |

3

Internal Configuration

| | |
|---------|---|
| -1 | Series trip |
| -1REC4C | Mechanical trip auxiliary switch* |
| -1RS4C | Electrical trip auxiliary switch* |
| -1RLS4C | Electrical trip auxiliary switch* (mid-trip only) |
| -1REG4C | Series trip with auxiliary switch* 0.110 quick-connects (gold contacts) |
| -1REC40 | Mechanical trip auxiliary switch** |
| -1RS40 | Electrical trip auxiliary switch* |
| -1RLS40 | Electrical trip auxiliary switch* (mid-trip only) |
| -1REG40 | Series trip with auxiliary switch* 0.110 quick-connects (gold contacts) |

* Alarms when circuit breaker closes
 ** Alarms when circuit breaker opens

Only one auxiliary switch is normally supplied on two pole units. Switch is located in the right hand pole (viewed from terminal end) unless otherwise specified.

4

Frequency & Delay

| | |
|-----|---|
| -51 | DC short delay |
| -52 | DC long delay |
| -53 | DC motor start / extra long delay |
| -59 | DC 125% instant trip |
| -61 | 50 - 60 Hz short delay |
| -62 | 50 - 60 Hz Long Delay |
| -63 | 50 - 60 Hz motor start / extra long delay (30A max) |
| -69 | 50 - 60 Hz 125% instant trip |

8

TÜV Approval

Per first decision's description: The shaded areas denote TÜV approval options. This approval requires the addition of a "T" at the end of the part number (8th decision).

7

Handle Color & Markings

| | | | |
|-----|--------|-----|------------------------------------|
| -00 | Black | -01 | Black w/ white markings (standard) |
| -10 | Yellow | -11 | Yellow w/ black markings |
| -20 | Red | -21 | Red w/ white markings |
| -30 | Blue | -31 | Blue w/ white markings |
| -40 | Green | -41 | Green w / white markings |
| -60 | Orange | -61 | Orange w/ black markings |
| -90 | White | -91 | White w/ black markings |

6

Optional

| | |
|----|--|
| -A | Metric thread mounting (M3) & terminals (M5) |
| -B | Barrier (AC only) |
| -C | 65 VDC |
| -D | 80VDC |
| -E | 0.312" diameter bullet (standard is 0.250" when prefix with "B" is chosen in first decision) |
| -F | 250VAC |
| -L | Handle Lock |

Notes:
 1. One or more descriptions may be used as required (for example, to get a barrier, 250VAC and handle lock, put -BFL)
 2. When the sixth decision is not required, the seventh decision may be substituted and U.S. thread will be supplied

5

Rated Current

Use three numbers to print required current value between 2.00 amps minimum and 50.0 amps maximum.

