

**PART No. 2CSBX263618**

for more information visit  
[www.hammfg.com](http://www.hammfg.com)

Data subject to change without notice

Isometric drawing Not to Scale

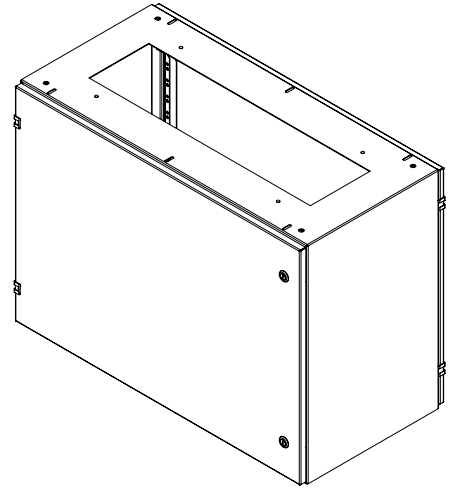

**ISOMETRIC VIEW**

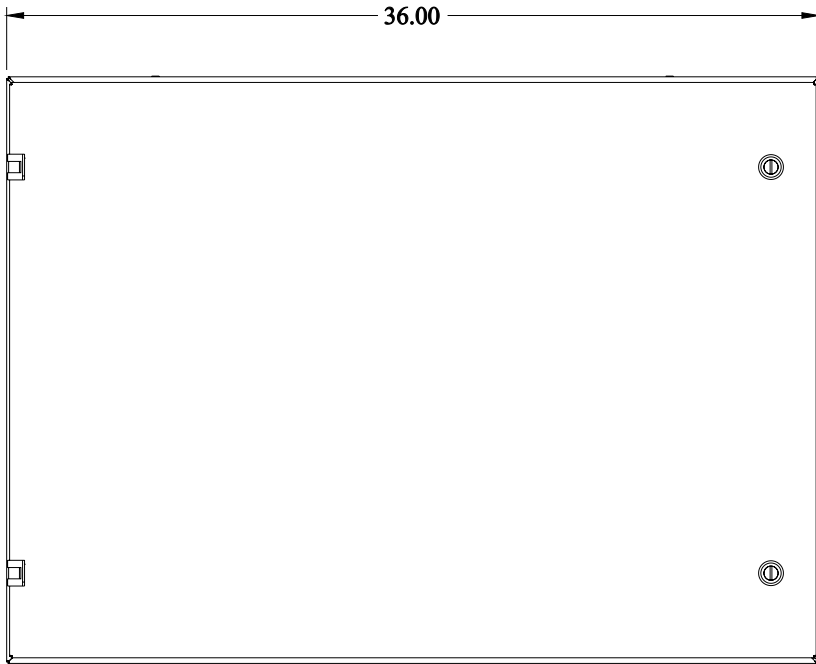

**FRONT VIEW**

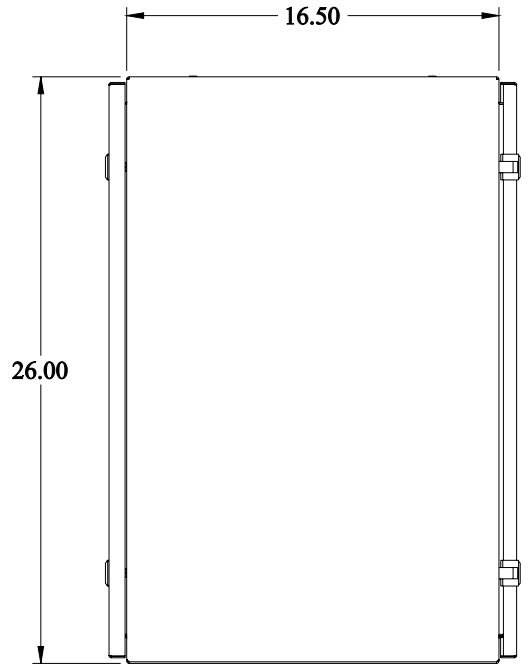

**RIGHT SIDE VIEW**