

SPECIFICATION

- Part No.** : **GWLA.10**
- Description** : GPS/GALILEO & Dual-Band Wi-Fi Ceramic Loop Antenna
Embedded 2in1 Structure
- Features** : Tiny Size
Omnidirectional
3.2*1.6*0.5mm
High Efficiency
Multi-Band Application
1575.42MHz GPS/GALILEO and 2.4/5.8GHz
Wi-Fi
Two Separate Feeds on one Antenna
Economical
Low profile
Surface-Mount
RoHS compliant

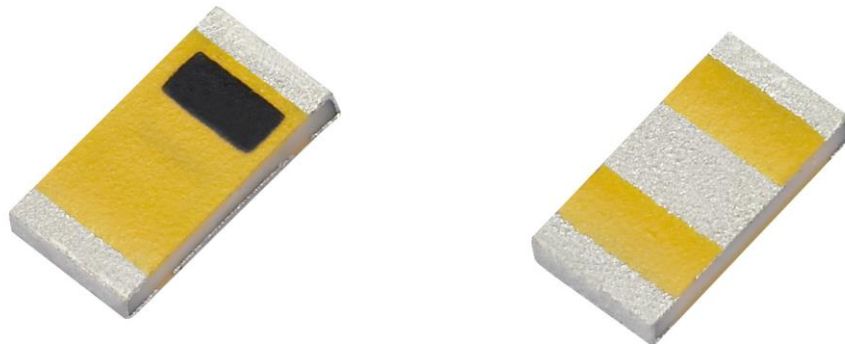

1. Introduction

The GWLA.10 GPS/GALILEO and 2.4/5.8GHz 2in1 Embedded Ceramic Loop antenna is a high efficiency, miniature SMD, edge mounted ceramic antenna for GPS/GALILEO and Wi-Fi, WLAN, ZigBee, Bluetooth, and 802.11ac applications where PCB space is limited, such as hand-held devices. Rather than using two separate chip antennas for GPS/GALILEO and Wi-Fi, the GWLA.10 has two separate antenna feeds in a single antenna body, making it the ideal choice for applications where there is limited PCB space and where low cost is important. The GWLA.10 uses the main PCB as its ground plane, thereby maintaining good efficiency despite its small size. The GWLA.10 can be tuned for different PCB sizes/environments by changing the values of the matching circuit. This needs to be carefully calculated, contact a regional Taoglas facility for support. Also be aware that smaller ground-planes will reduce the efficiency of the antenna.

At 3.2*1.6*0.5mm, the GWLA.10 is one of the smallest antennas available worldwide. This antenna is delivered on tape and reel and manufactured in a TS16949 first tier automotive approved facility.

The GPS/GALILEO performance is excellent, with high efficiency and an omnidirectional pattern. The Wi-Fi performance is also great and delivers stable efficiency and radiation pattern too, allowing this antenna to be used in a huge variety of devices.

Typical Applications – Where GPS/GALILEO and Dual-Band Wi-Fi are required

- Navigation or Position Tracking Systems
- Handheld Devices
- Tablets
- POS Systems
- Gateways and Routers
- Mobile Wireless Camera Systems
- OBD Devices

Many module manufacturers specify peak gain limits for any antennas that are to be connected to that module. Those peak gain limits are based on free-space conditions. In practice, the peak gain of an antenna tested in free-space can degrade by at least 1 or 2 dB when put inside a device. So ideally you should go for a slightly higher peak gain antenna than mentioned on the module specification to compensate for this effect, giving you better performance.

Upon testing of any of our antennas with your device and a selection of appropriate layout, integration technique, or cable, Taoglas can make sure any of our antennas' peak gain will be below the peak gain limits. Taoglas can then issue a specification and/or report for the selected antenna in your device that will clearly show it complying with the peak gain limits, so you can be assured you are meeting regulatory requirements for that module.

For example, a module manufacturer may state that the antenna must have less than 2 dBi peak gain, but you don't need to select an embedded antenna that has a peak gain of less than 2 dBi in free-space. This will give you a less optimized solution. It is better to go for a slightly higher free-space peak gain of 3 dBi or more if available. Once that antenna gets integrated into your device, performance will degrade below this 2 dBi peak gain due to the effects of GND plane, surrounding components, and device housing. If you want to be absolutely sure, contact Taoglas and we will test. Choosing a Taoglas antenna with a higher peak gain than specified by the module manufacturer and enlisting our help will ensure you are getting the best performance possible without exceeding the peak gain limits.

2. Specification

Electrical*			
Application Bands	GPS/GALILEO Antenna	Wi-Fi Antenna	
Frequency (MHz)	1575.42	2400-2500	5150-5850
Bandwidth (MHz)	35 (RL<-10dB)	100 (RL<-10dB)	820 (RL<-6dB)
Peak Gain (dBi)	1.36	0.27	1.86
Efficiency (%)	57.06	51.25	53.56
Return Loss (dB)	< -10	< -10	< -6
Isolation (dB)	>15	>10	>25
Impedance	50Ω		
Polarization	Linear		
Input Power	2W		
MECHANICAL			
Dimensions	3.2*1.6*0.5mm		
Ground Plane	80*40mm (Standard Evaluation Board)		
Weight	0.02g		
ENVIRONMENTAL			
Operating Temperature	-40°C to 85°C		
Storage Temperature	-25°C to 85°C		
Relative Humidity	20% to 70%		

*Tested on 80*40mm evaluation board.

3. Antenna Characteristics

3.1 GPS/GALILEO Band

3.1.1 Return Loss

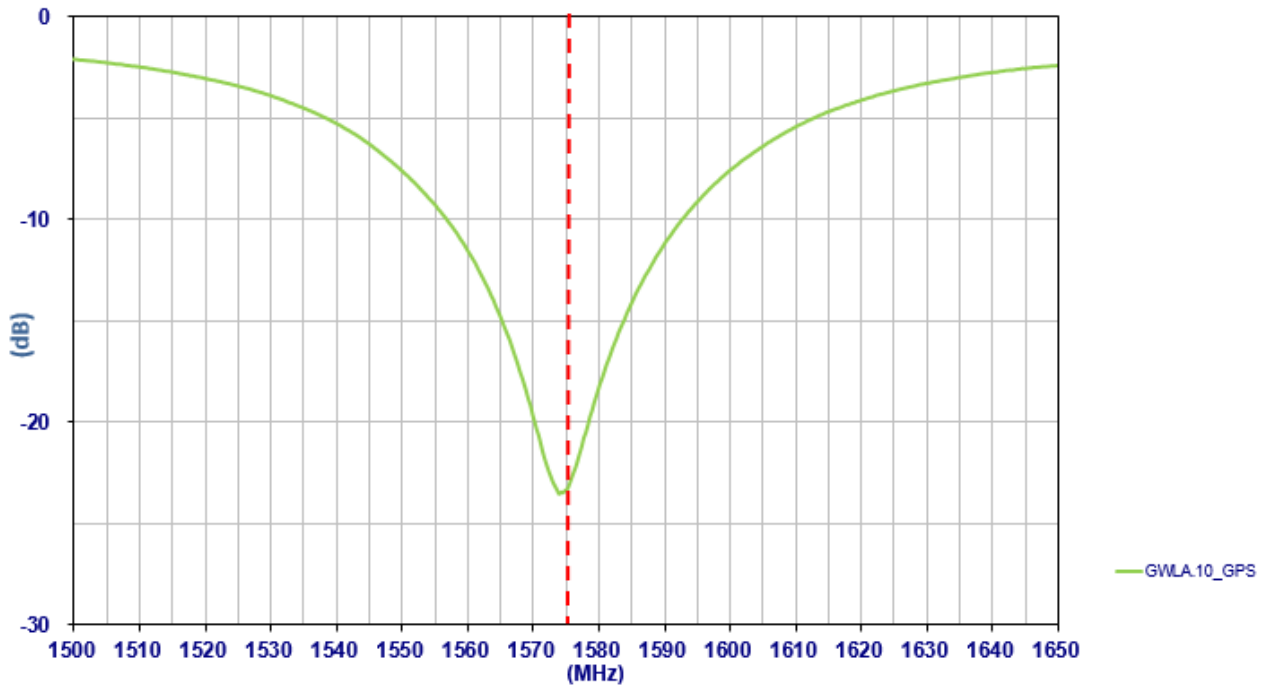

3.1.2 Efficiency

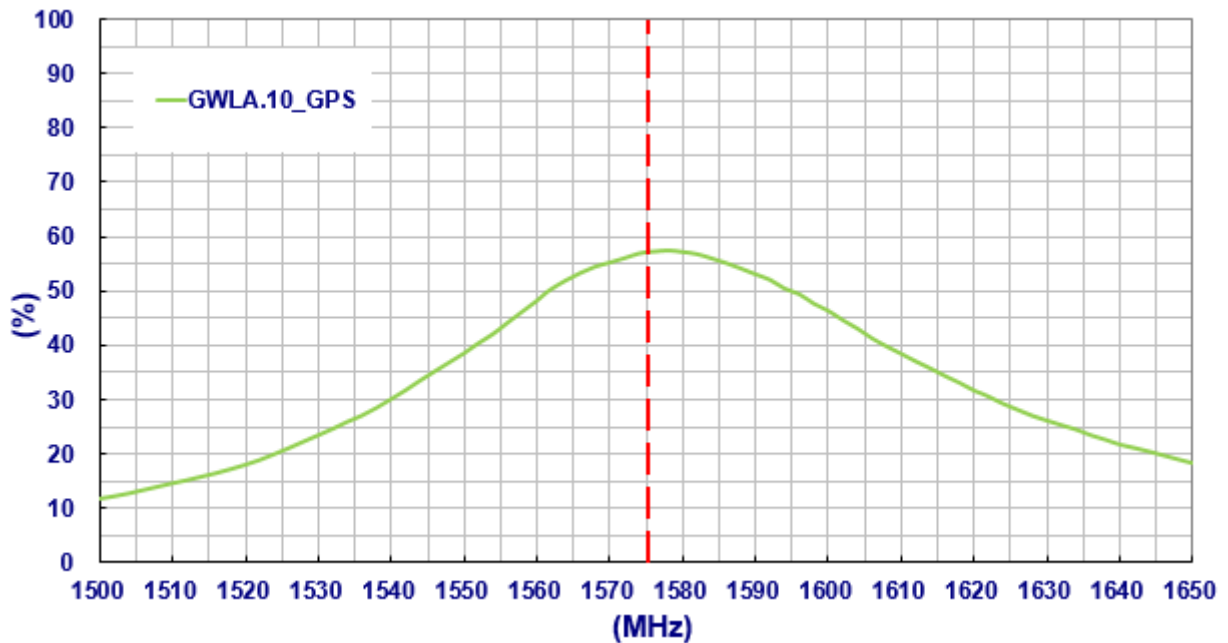

3.1.3 Peak Gain

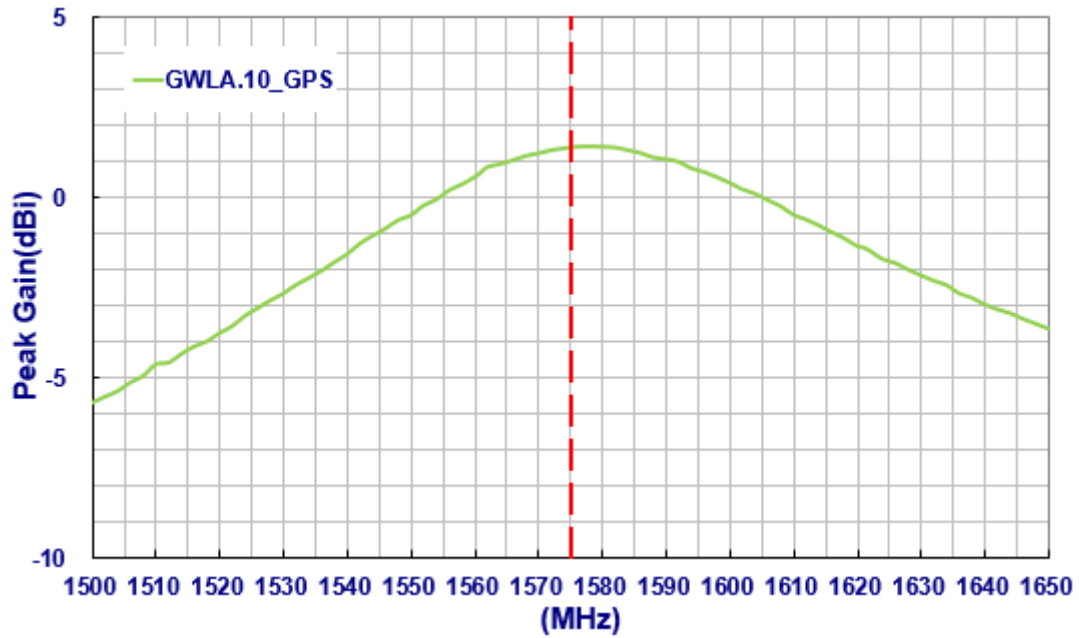

3.2 Wi-Fi Dual-Band

3.2.1 Return Loss

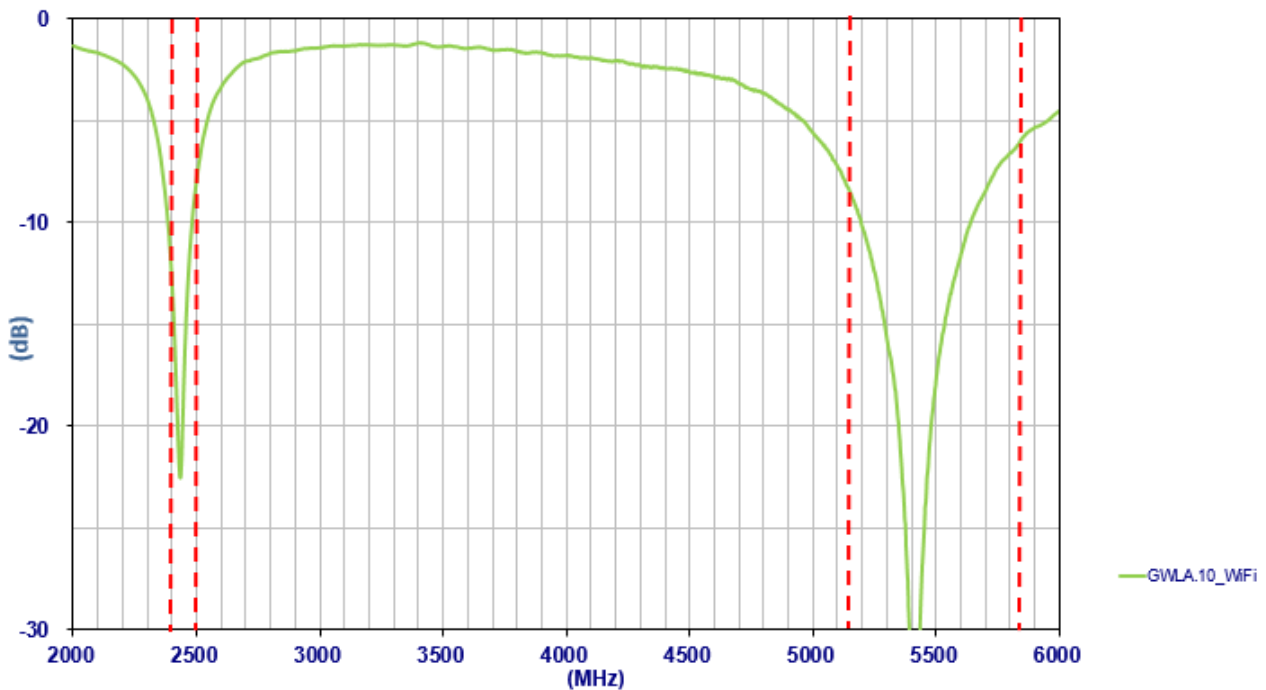

3.2.2 Efficiency

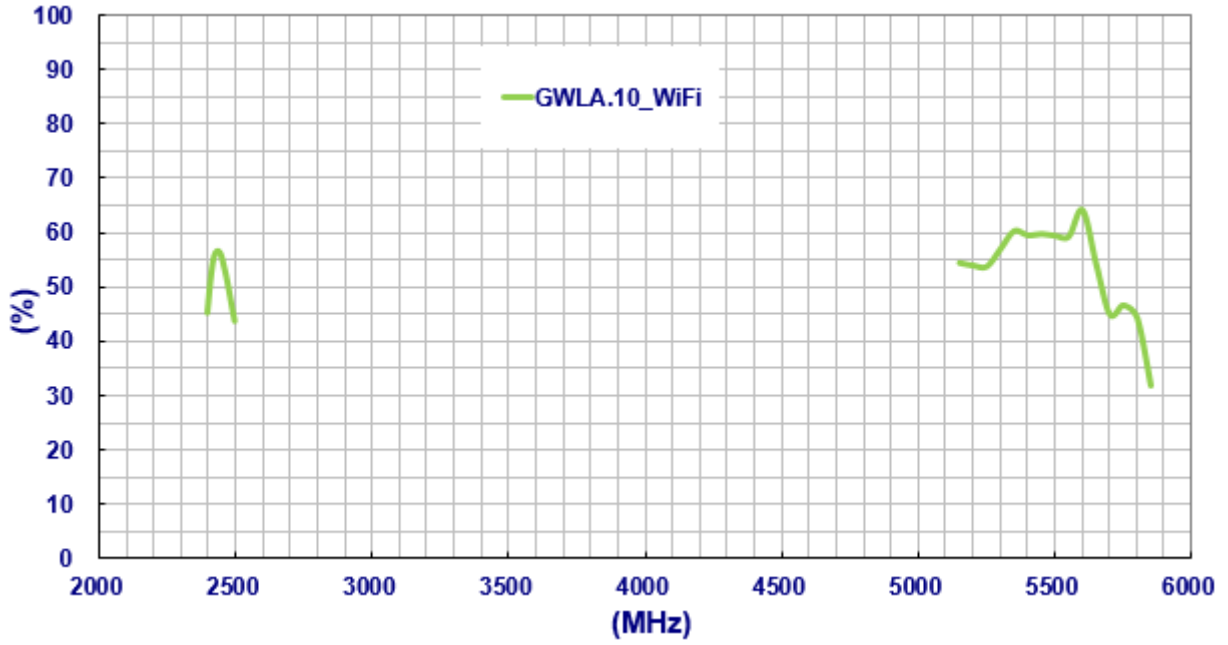

3.2.3 Peak Gain

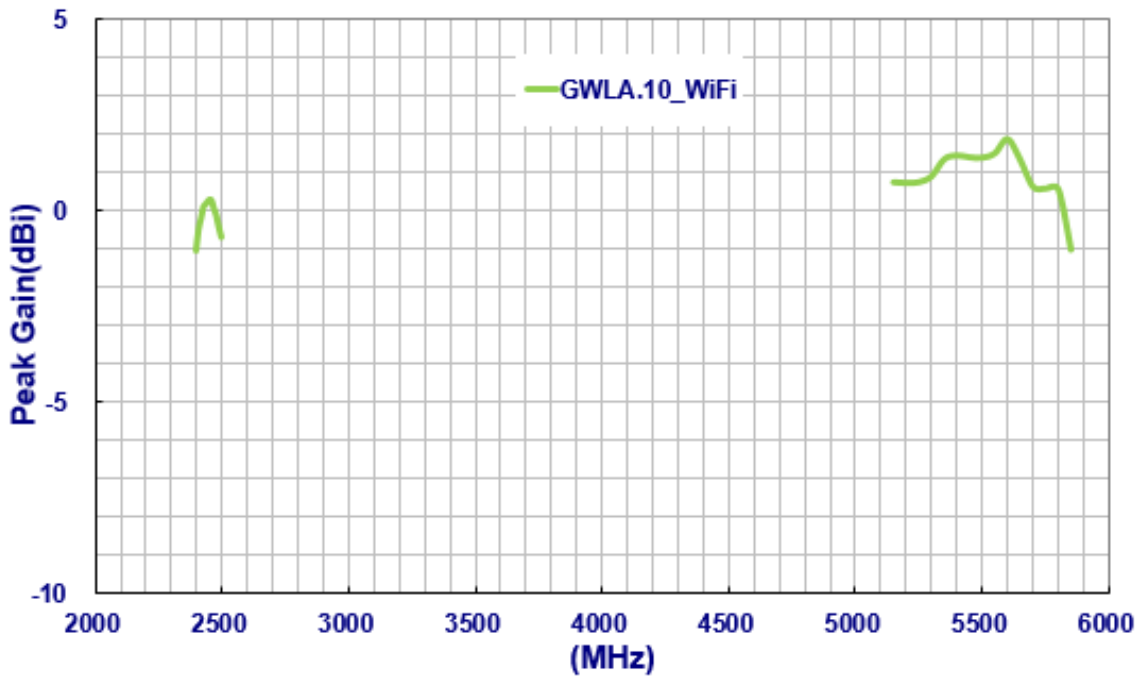

3.3 Isolation

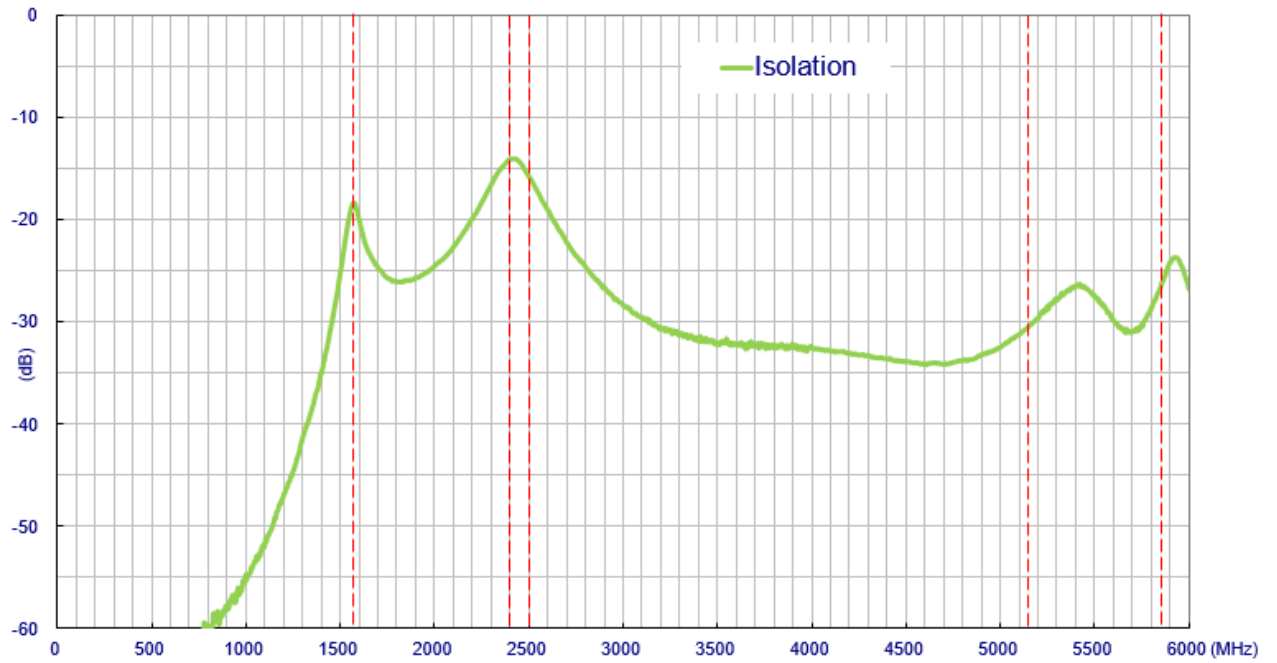

4. Antenna Radiation Pattern

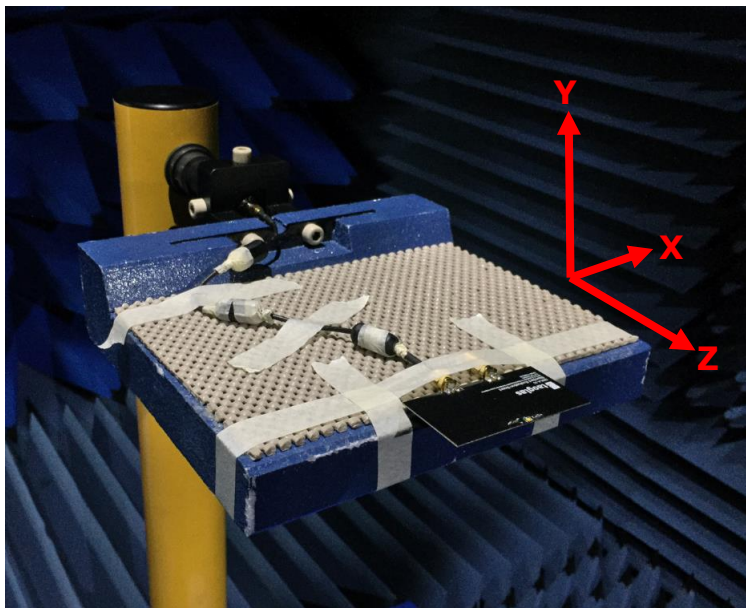

4.1 2D Gain Pattern@ GPS/GALILEO 1575.42MHz

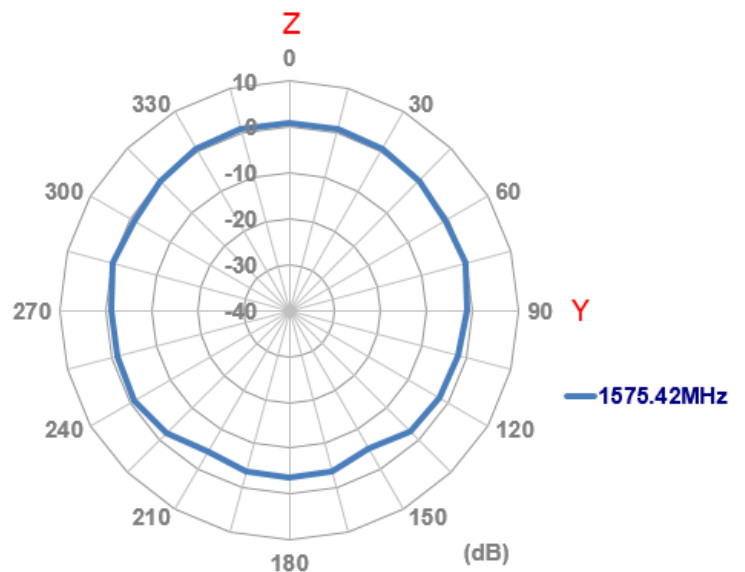
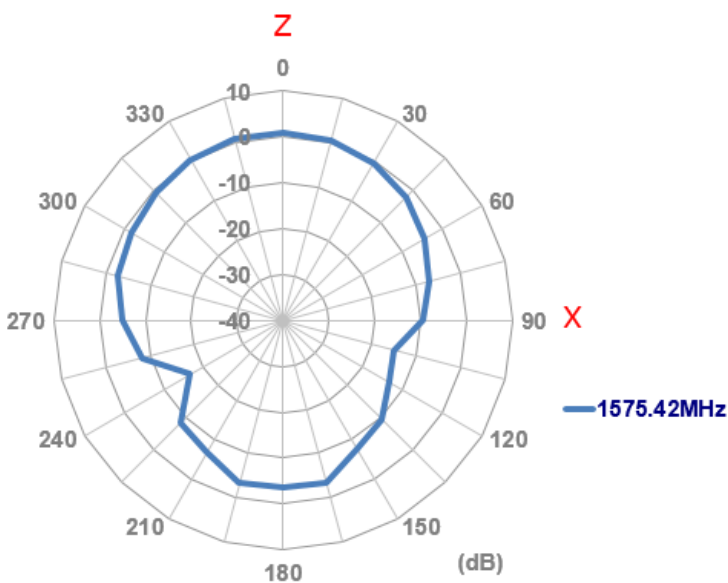
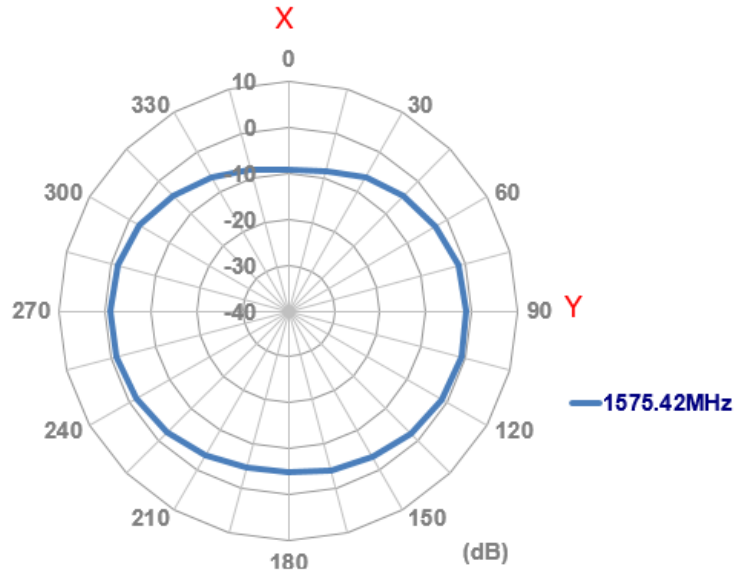

4.2 3D Gain Pattern@ GPS/GALILEO 1575.42MHz

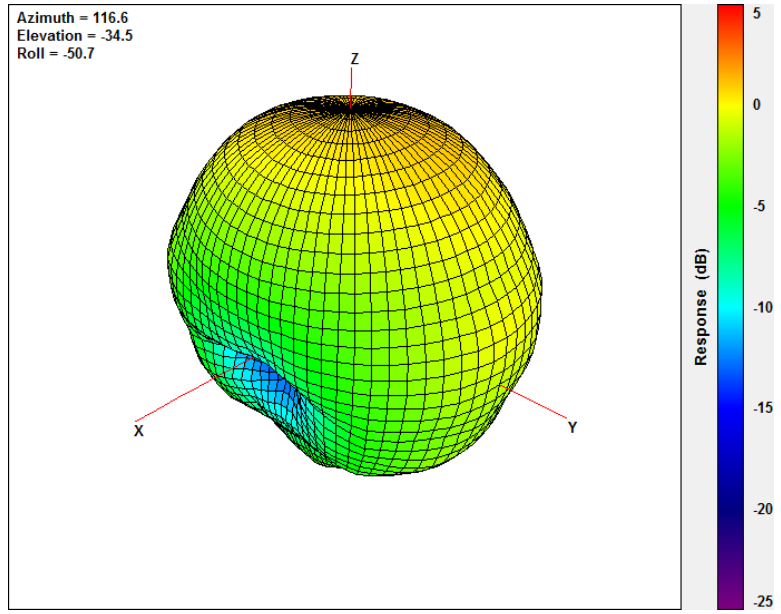

4.3 2D Gain Pattern@ Wi-Fi Dual Bands

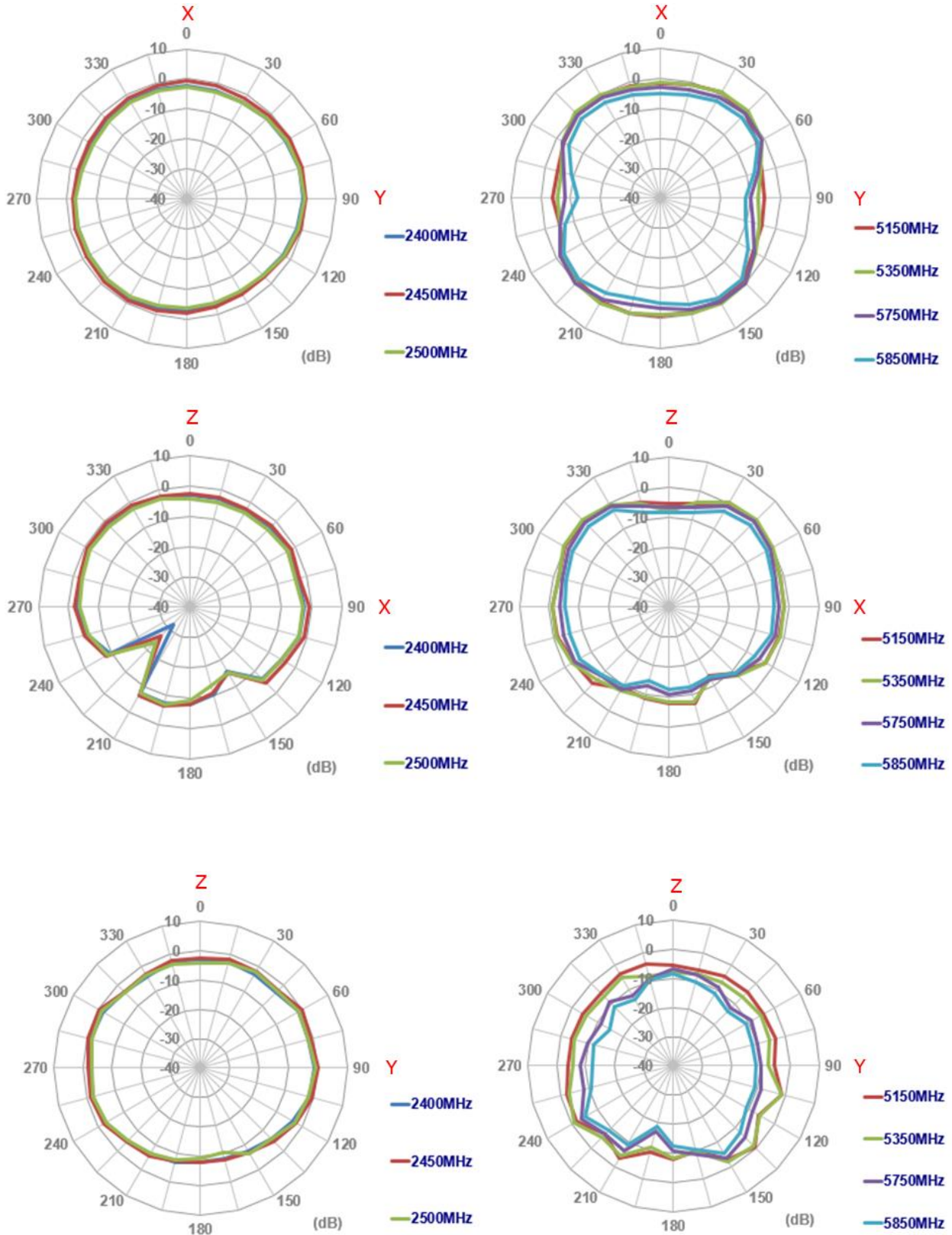

4.4 3D Gain Pattern@ Wi-Fi Dual Bands

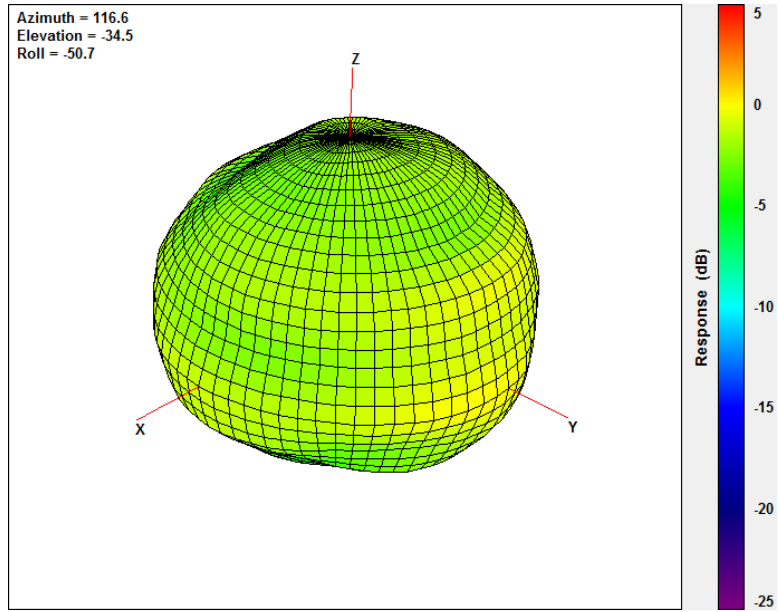

@2450MHz

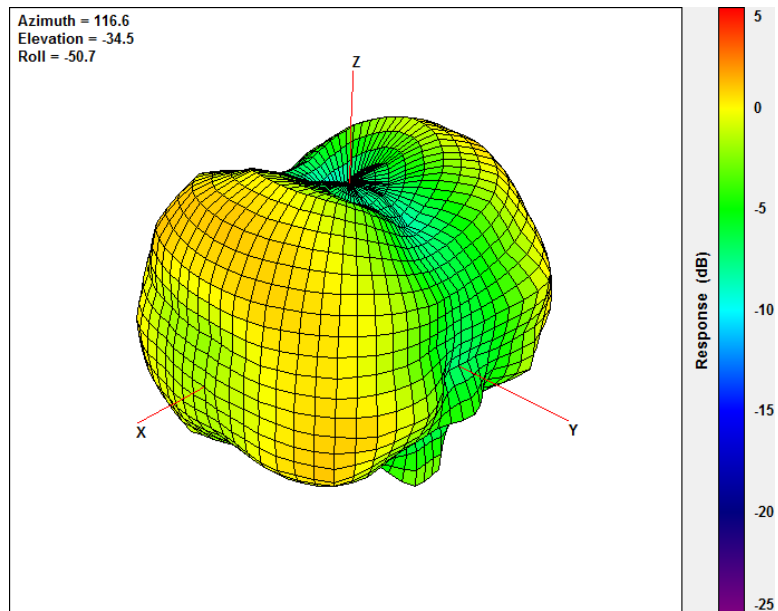

@5500MHz

5. Mechanical Drawing (Unit: mm)

5.1 GWLA.10

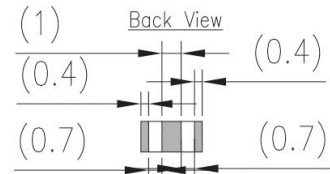
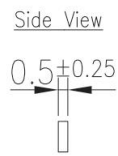
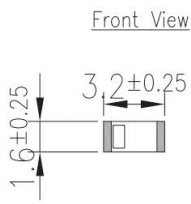

5.2 GWLAD.10

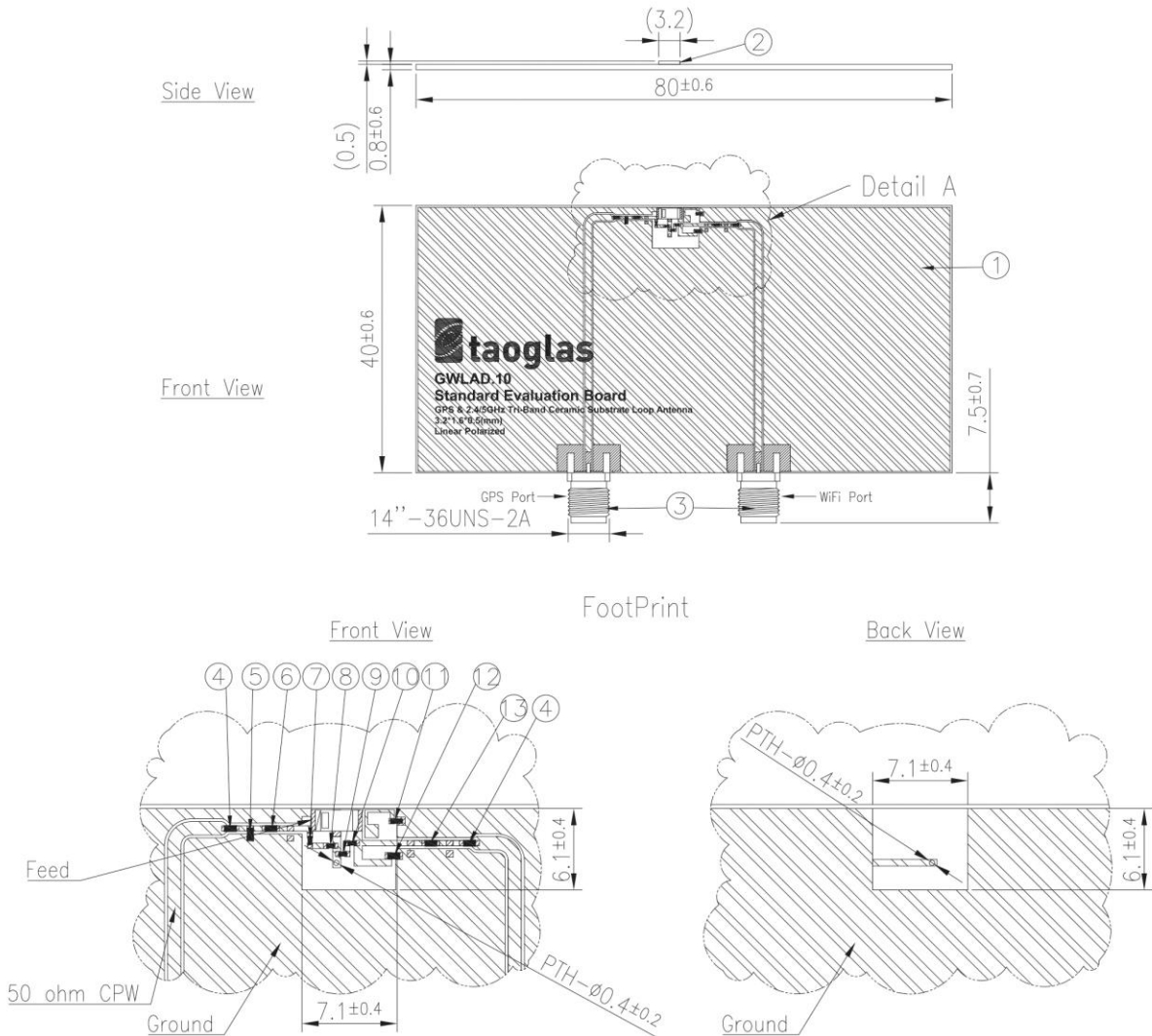

	Name	Material	Finish	QTY
1	GWLAD.10 EVB Board	Composite	Black	1
2	GWLA.10 Chip Antenna	Ceramic	N/A	1
3	SMA(F) ST	Brass	Au Plated	2
4	Capacitor 22pF (0402)	Ceramic	N/A	2
5	Capacitor 2.7pF (0402)	Ceramic	N/A	1
6	Capacitor 7.0pF (0402)	Ceramic	N/A	1
7	Capacitor 1.0pF (0201)	Ceramic	N/A	1
8	Capacitor 0.9pF (0201)	Ceramic	N/A	1
9	Capacitor 0.8pF (0201)	Ceramic	N/A	1
10	0Ω Resistor (0201)	Ceramic	N/A	1
11	Capacitor 0.6pF (0201)	Ceramic	N/A	1
12	Capacitor 18pF (0402)	Ceramic	N/A	1
13	Inductor 1.0nH (0402)	Ceramic	N/A	1

6. Layout Guide

6.1 Footprint

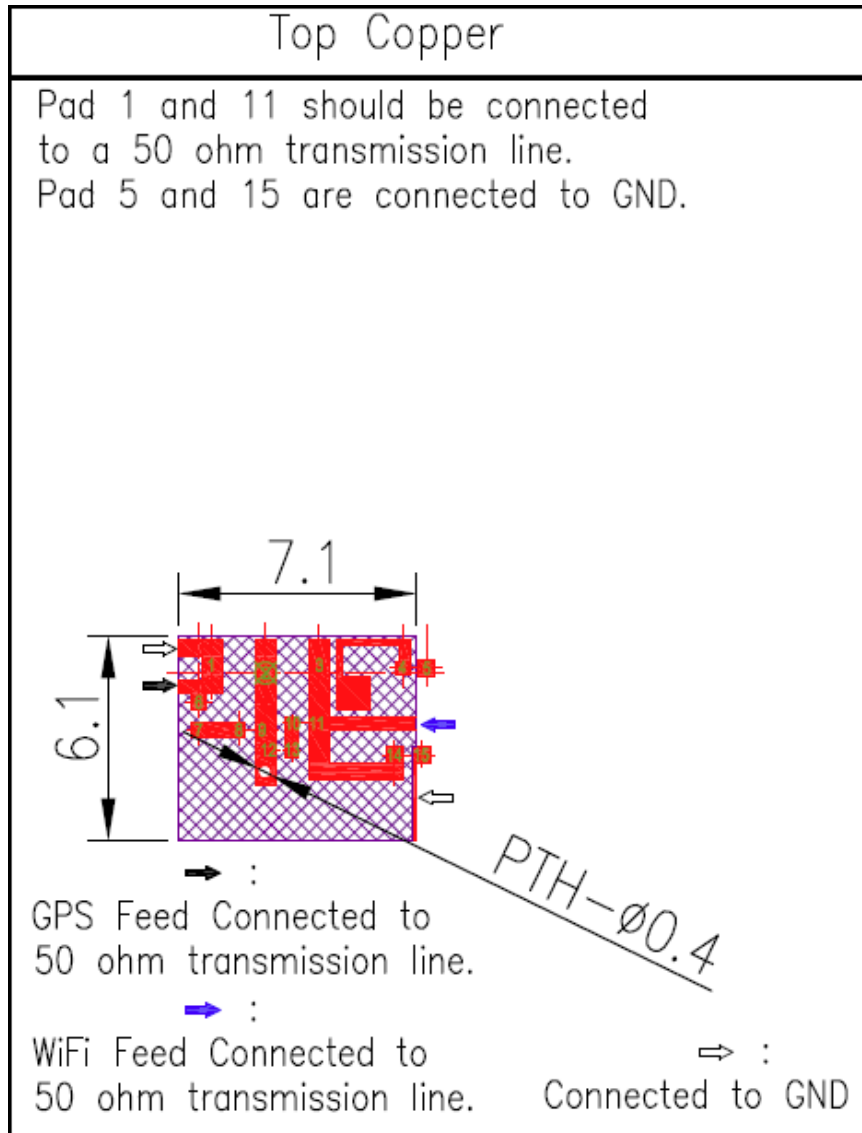

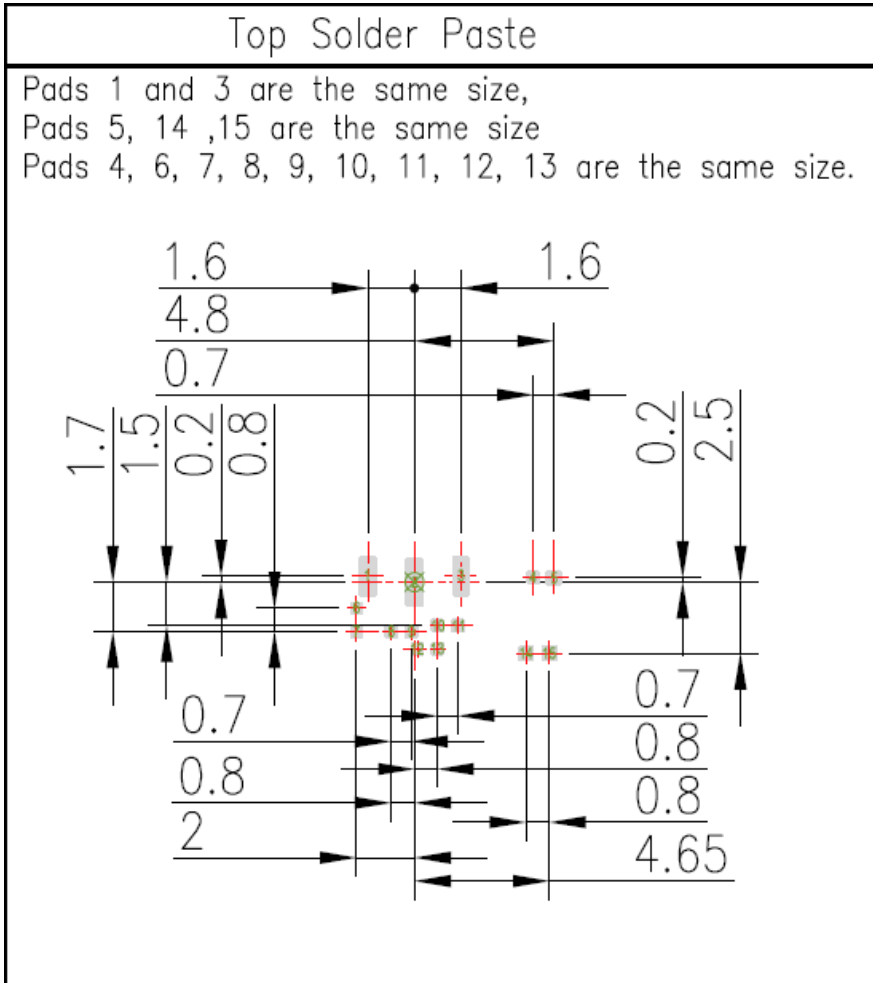

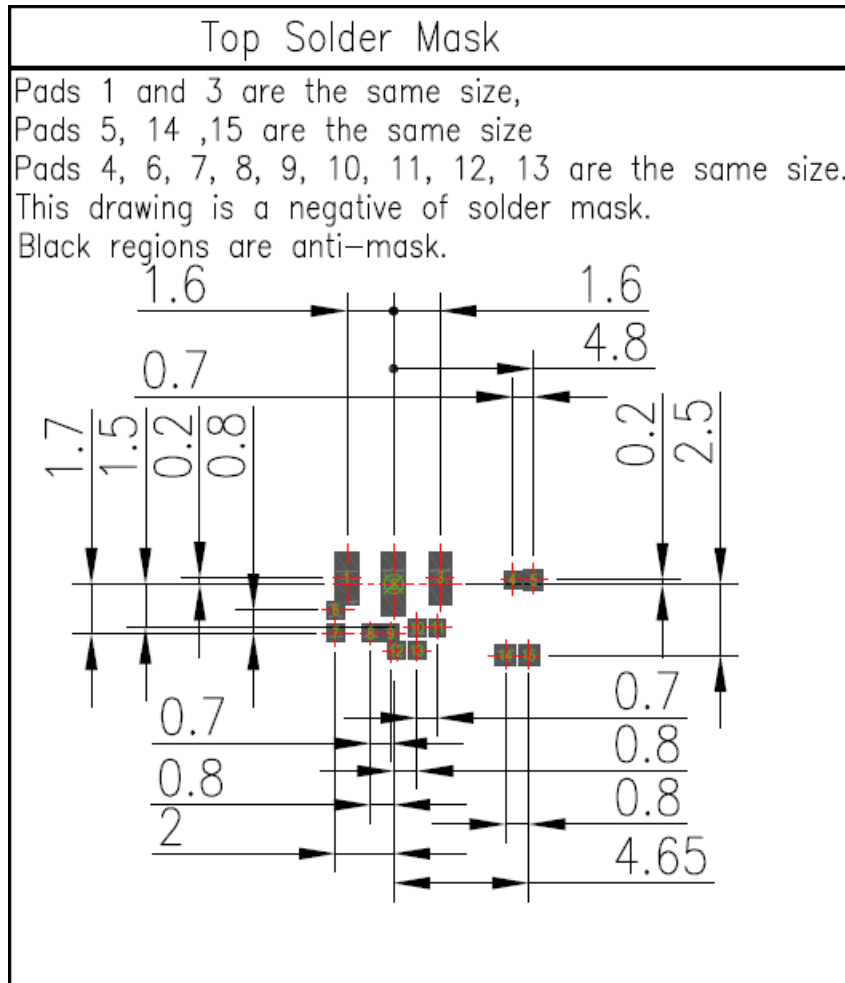

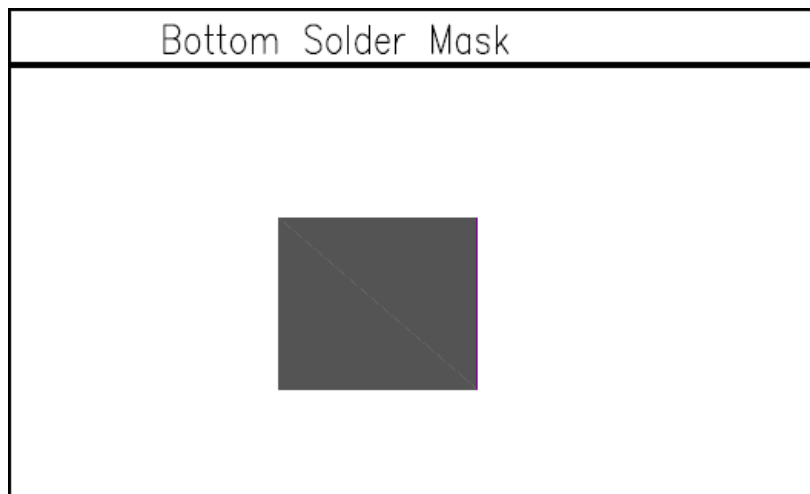
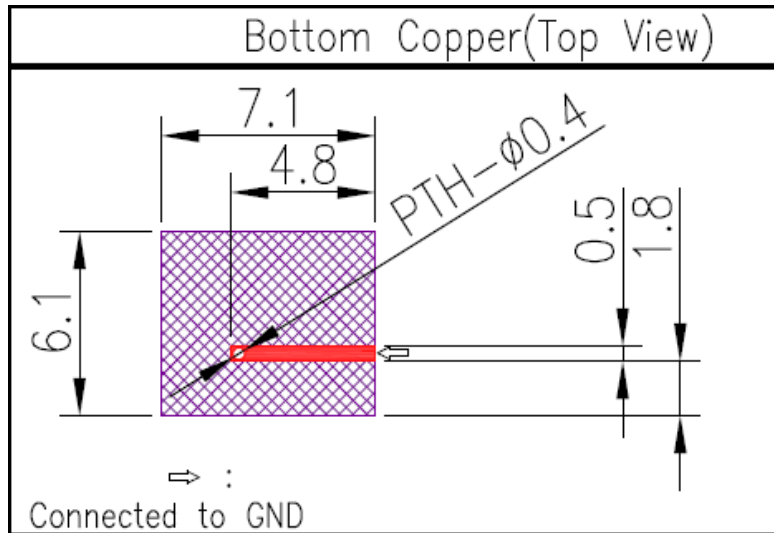

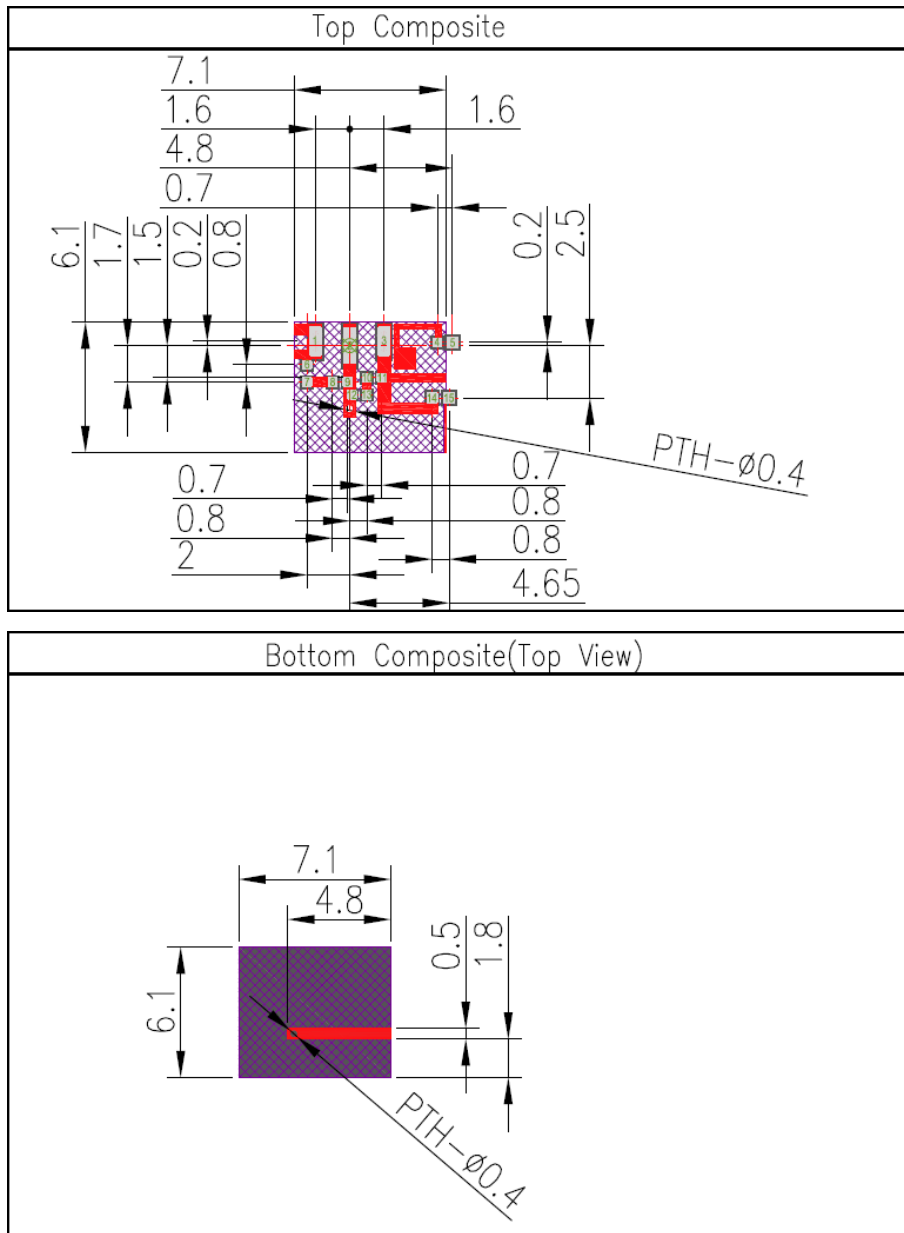

- NOTE:
- | | | |
|------------------------|--|--|
| 1. Ag Plated area | | 6. Ground keepout should extend from top layer through all inner PCB layers to minimize coupling from RF feed to ground. |
| 2. Solder Mask area | | 7. Any vias in pads should be either filled or tented to prevent solder from wicking away from the pad during reflow. |
| 3. Copper area | | 8. The dimension tolerances should follow standard PCB manufacturing guidelines |
| 4. Paste area | | |
| 5. Copper Keepout Area | | |

* Footprint drawings in .dwg format will be provided upon request.

6.2 Matching Circuit

Like all antennas, surrounding components, enclosures, and changes to the GND plane dimensions can alter performance. A pi-matching network like the one shown below is required in case adjustments need to be made. The antenna EVB has a similar matching network. The components on the EVB are a good starting point for a new design, but will need to be adjusted upon integration for best performance. The zero ohm resistor is needed to solder down a coax pigtail to make measurements with a vector network analyzer.

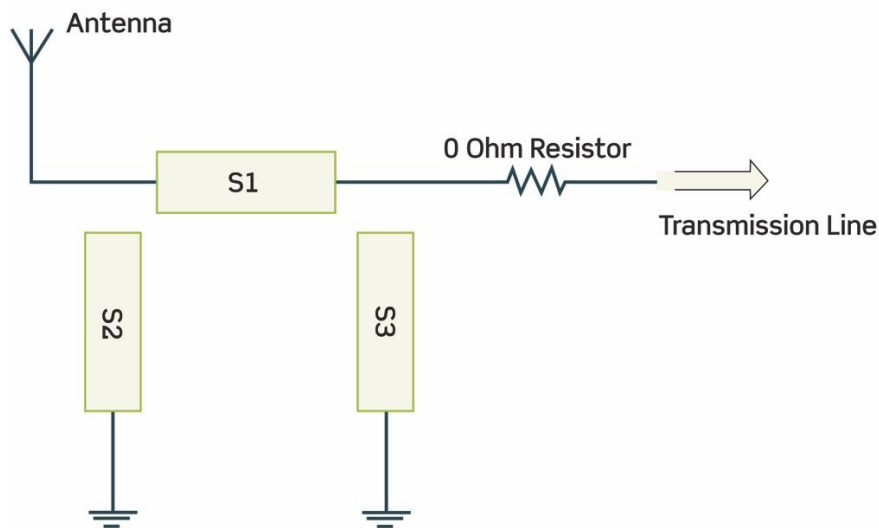

7. Solder Reflow Profile

Typical soldering profile for lead-free process:

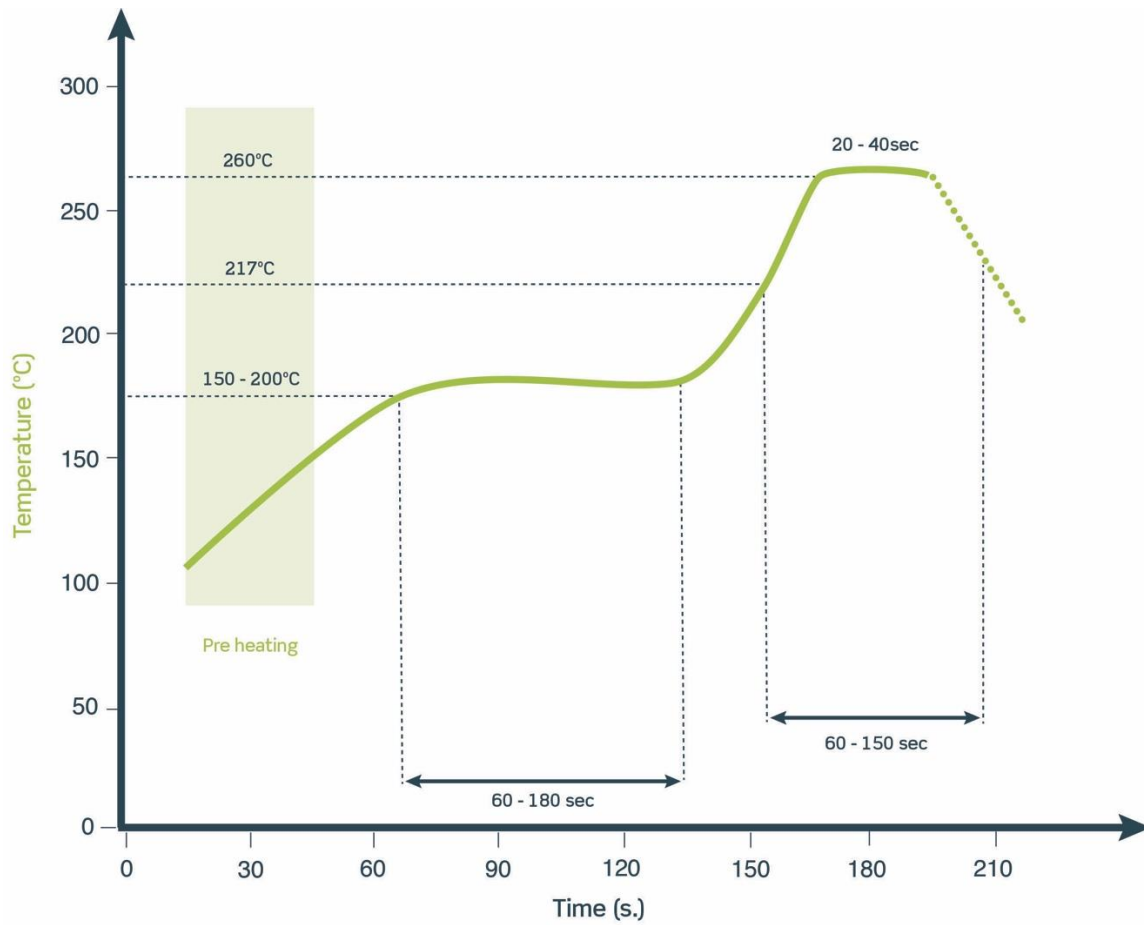

8. Packaging

5000 pcs GWLA.10 per tape & reel
 Dimensions - 330*330*17mm
 Weight - 484g

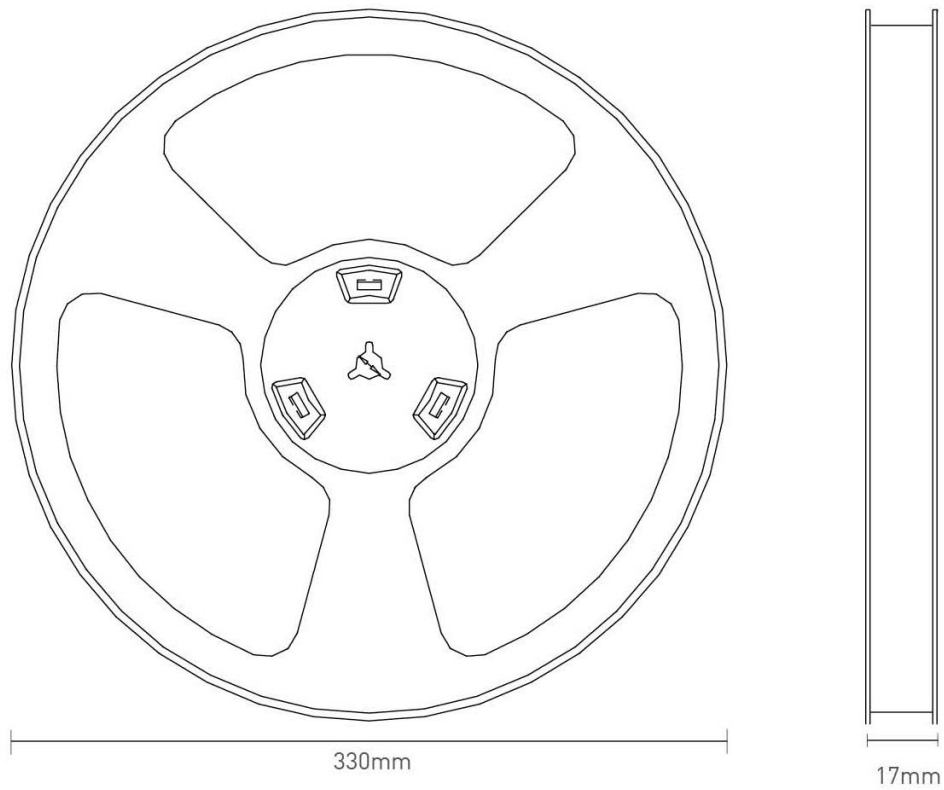

Tape Dimensions (unit: mm)		
Feature	Spec	Tolerances
W	12.00	±0.30
P	4.00	±0.10
E	1.75	±0.10
F	5.50	±0.10
P2	2.00	±0.10
D	1.50	+0.10 -0.00
Po	4.00	±0.10
10Po	40.00	±0.10

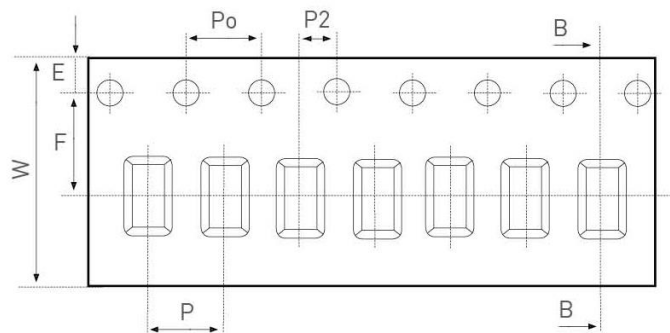

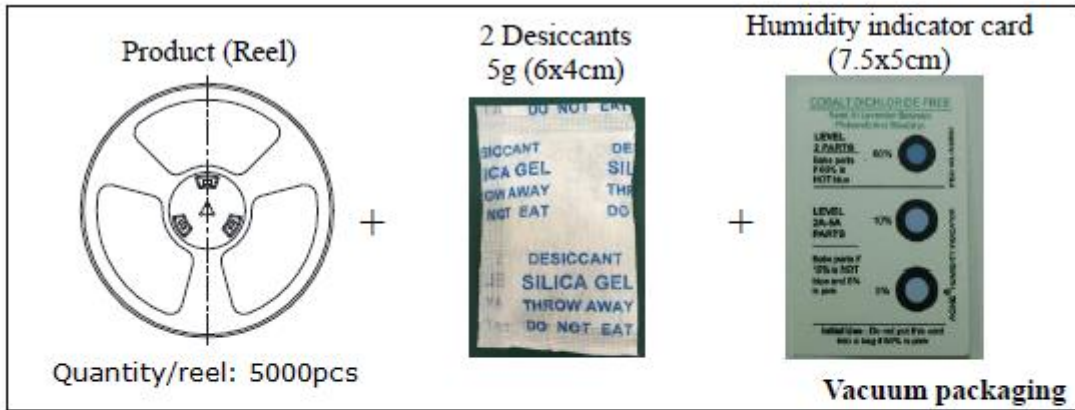

5000 pcs GWLA.01
1 reel in small inner box
Dimensions - 330*330*17
Weight - 484g

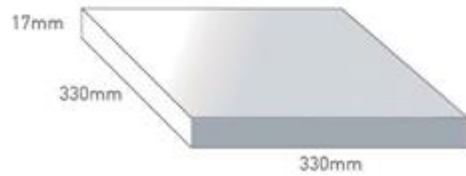

9 boxes / 45000 pcs in one carton
Carton Dimensions - 350*350*210mm
Weight - 4.89Kg

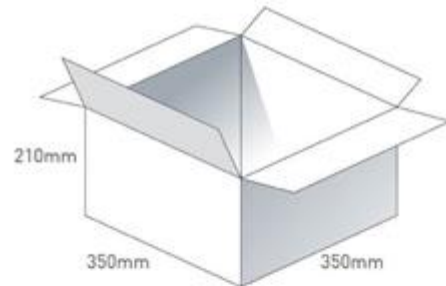

Pallet Dimensions 1220*1020*1410mm
36 Cartons per Pallet
4 Cartons per layer
9 Layers

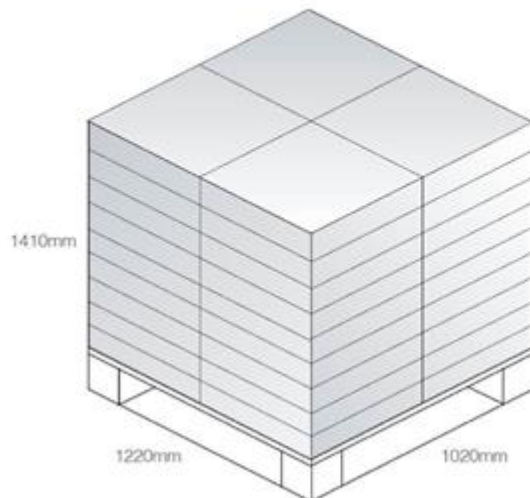



Taoglas makes no warranties based on the accuracy or completeness of the contents of this document and reserves the right to make changes to specifications and product descriptions at any time without notice. Taoglas reserves all rights to this document and the information contained herein.

Reproduction, use or disclosure to third parties without express permission is strictly prohibited.

Copyright © Taoglas Ltd.