

# High Voltage Isolator

## OPI1268



### Features:

- TTL compatible output
- 16 kV dc isolation
- 2Mbit/s
- $t_{PHL}-t_{PLH} \leq 500$  ns
- Creepage path: 0.970" (24.64 mm)
- Air path: 0.970" (24.64 mm)
- UL recognized file No. E58730



### Description:

The **OPI1268** is a high voltage isolator with a digital output that is capable of high speed data transmission. The input of the OPI1268 consists of a high-efficiency GaAlAs LED with a peak wavelength of 850 nm, which is optically coupled to the output optical IC. A photodiode in the output IC detects the incoming modulated light and converts it to a proportionate current. This current is fed into a high-gain linear amplifier which is temperature, current and voltage compensated. The result is a highly stable digital output with an open collector inverter configuration. This device produces DC and AC voltage isolation between the input and output circuitry while providing TTL signal integrity.

### Applications:

- Data transmission for High voltage isolation
- PCBoard power system isolation
- Industrial equipment power isolation
- Medical equipment power isolation
- Office equipment

Ordering Information							
Part Number	LED Peak Wavelength	Sensor Photologic®	Isolation Voltage kVDC	$t_{PLH} / t_{PHL}$ Max (ns)	$I_f$ (mA) Typ / Max	$V_{CE}$ (V) Max	Lead Length / Spacing
OPI1268	850 nm	Open Collector	16	100 / 200	10 / 50	18	0.12" / 0.98"

Pin	Function
1	Cathode
2	Anode
3	Vcc
4	Output
5	Ground

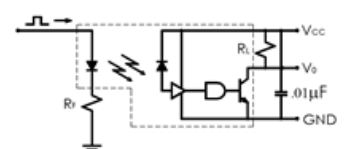
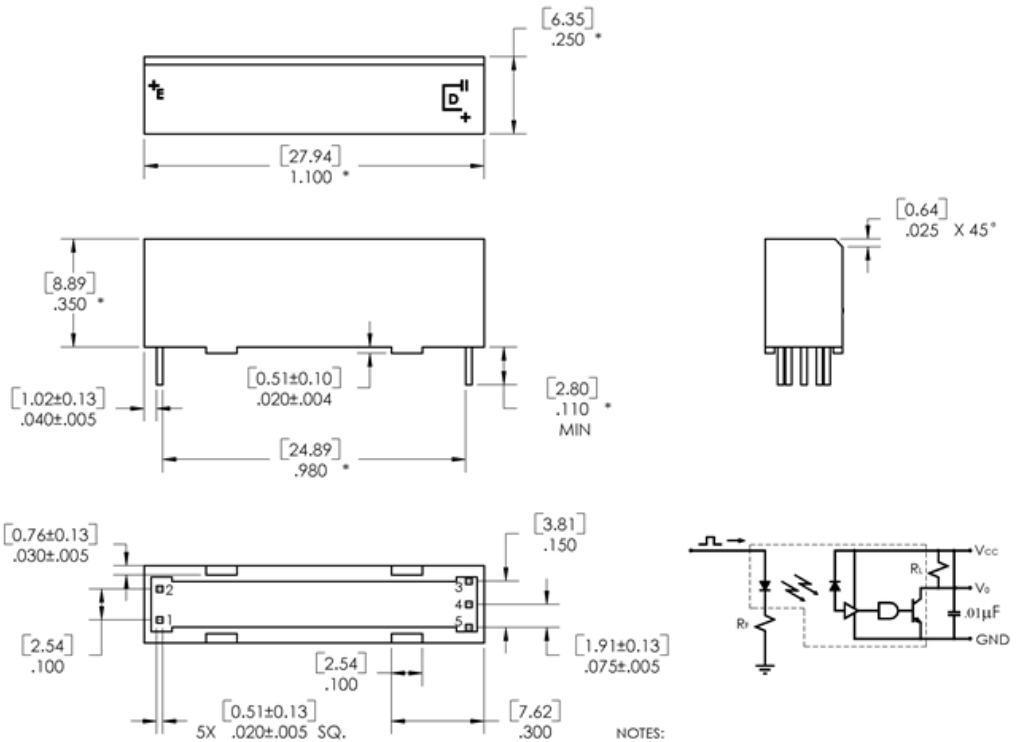

General Note  
 TT Electronics reserves the right to make changes in product specification without notice or liability. All information is subject to TT Electronics' own data and is considered accurate at time of going to print.

TT Electronics | OPTEK Technology  
 1645 Wallace Drive, Carrollton, TX 75006 | Ph: +1 972 323 2200  
 www.ttelectronics.com | sensors@ttelectronics.com

# High Voltage Isolator

OPI1268



## Absolute Maximum Ratings ( $T_A = 25^\circ\text{C}$ unless otherwise noted)

Storage Temperature	-40° C to +100° C
Operating Temperature	-40° C to +100° C
Input-to-Output Isolation Voltage <sup>(2)</sup>	16 kVDC
Lead Soldering Temperature (1/16" (1.6 mm) from case for 5 seconds with soldering iron) <sup>(3)</sup>	260° C
<b>Input Diode</b>	
Continuous Forward Current	30 mA
Peak Forward current (1 $\mu\text{s}$ pulse width, 300 pps)	3.0 A
Reverse Voltage	3.0 V
Power Dissipation <sup>(1)</sup>	100 mW
<b>Output IC</b>	
Maximum Supply Voltage	7 V
Power Dissipation <sup>(4)</sup>	40 mW
Maximum Output Voltage	18 V
Maximum Output Current	25 mA

## Electrical Characteristics ( $T_A = 0^\circ\text{C}$ to $70^\circ\text{C}$ unless otherwise noted)

SYMBOL	PARAMETER	MIN	TYP	MAX	UNITS	TEST CONDITIONS
<b>Input Diode</b>						
$V_F$	Forward Voltage	-	1.3	1.6	V	$I_F = 20\text{ mA}$
$I_R$	Reverse Current	-	0.1	100	$\mu\text{A}$	$V_R = 2.0\text{ V}$
<b>Output IC (<math>V_{CC} = 4.5\text{ V}</math> to <math>5.25\text{ V}</math>) (See OPL550 for additional information—for reference only.)</b>						
$I_{OH}$	High Level Output Current	-	0.20	10	$\mu\text{A}$	$I_F = 0.0\text{ mA}$ , $V_{OH} = 18.0\text{ V}$ , $V_{CC} = 5.25\text{ V}$
$V_{OL}$	Low Level Output Voltage	-	0.44	0.55	V	$I_F = 10.0\text{ mA}$ , $I_{OL} = 8.0\text{ mA}$ , $V_{CC} = 4.5\text{ V}$
$I_{CCH}$	High Level Supply Current	-	4.2	7	mA	$I_F = 0$ , $V_{CC} = 5.25\text{ V}$
$I_{CCL}$	Low Level Supply Current	-	6.7	10		$I_F = 10.0\text{ mA}$ , $V_{CC} = 5.25\text{ V}$
<b>Coupled Characteristics (<math>V_{CC} = 5\text{ V}</math>)</b>						
$C_{IO}$	Coupling Capacitance	-	-	2	pF	Input and output leads shorted.
$t_{PLH}$	Propagation Delay to Low Output Level	-	-	200	ns	$V_{CC}=5\text{V}$ , $I_F=30\text{mA}$ , $R_L=560\Omega$
$t_{PHL}$	Propagation Delay to High Output Level	-	-	100		
$I_{ISO}$	Isolation Leakage Current <sup>(5)</sup>	-	-	20	$\mu\text{A}$	$V_{ISO} = 19.2\text{kV dc}$
$I_{F+}$	LED Positive Going Threshold Current	0.8	1.7	5.0	mA	$V_{CC} = 5\text{V}$ , $I_{OL} = 8.0\text{mA}$

Notes:

- (1) Derate LED linearly 1.33 mW/°C above 25°C.
- (2) UL recognition is for 16kV dc for one minute.
- (3) RMA flux is recommended. The duration can be extended to 10 seconds maximum when flow soldering.
- (4) Derate linearly 0.54m W/°C above 25°C.
- (5) Measured with input leads shorted together and output leads shorted together in air with a maximum relative humidity of 50%.

General Note

TT Electronics reserves the right to make changes in product specification without notice or liability. All information is subject to TT Electronics' own data and is considered accurate at time of going to print.

TT Electronics | OPTEK Technology  
1645 Wallace Drive, Carrollton, TX 75006 | Ph: +1 972 323 2200  
www.ttelectronics.com | sensors@ttelectronics.com

# High Voltage Isolator

OPI1268

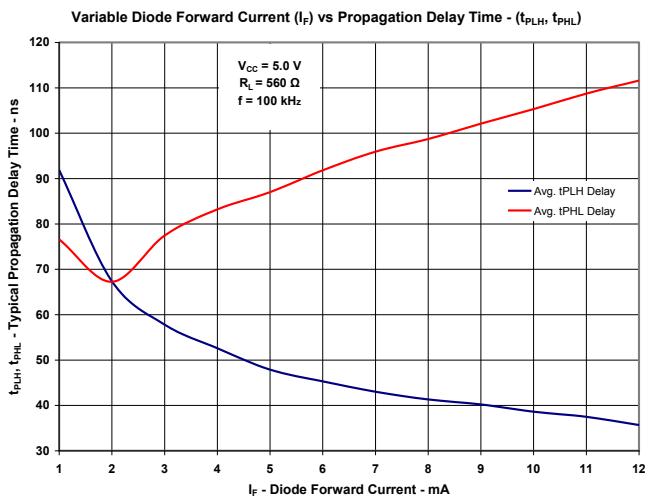
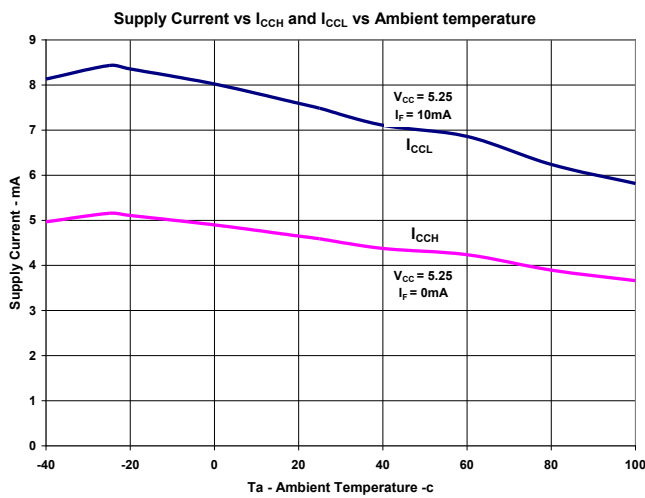
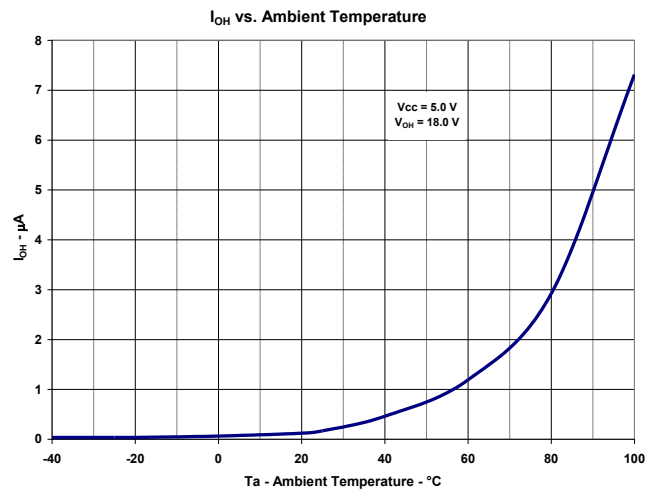
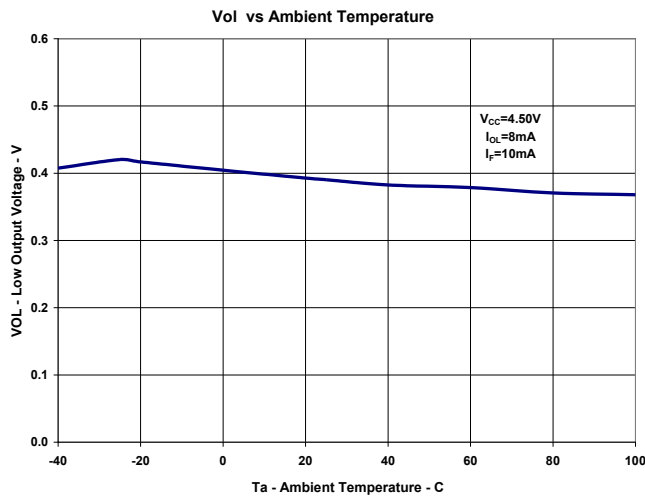
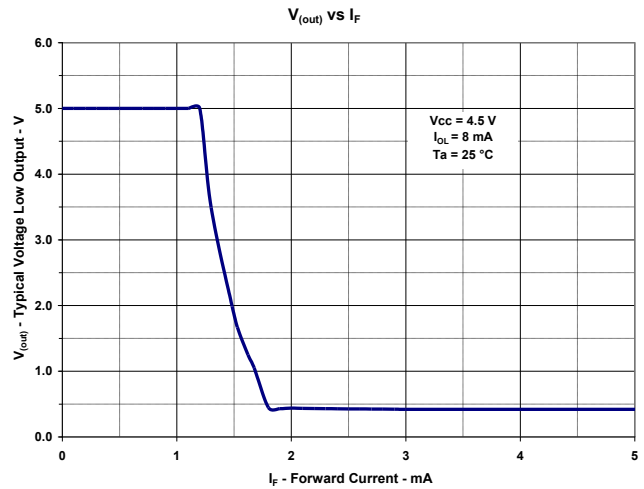
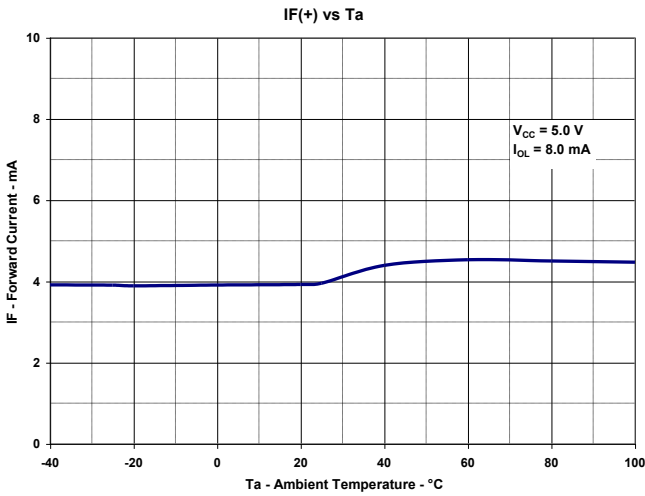

**General Note**

TT Electronics reserves the right to make changes in product specification without notice or liability. All information is subject to TT Electronics' own data and is considered accurate at time of going to print.

TT Electronics | OPTEK Technology  
1645 Wallace Drive, Carrollton, TX 75006 | Ph: +1 972 323 2200  
www.ttelectronics.com | sensors@ttelectronics.com

# High Voltage Isolator

## OPI1268



### dV/dT

OPI1268 dV/dT Emitter

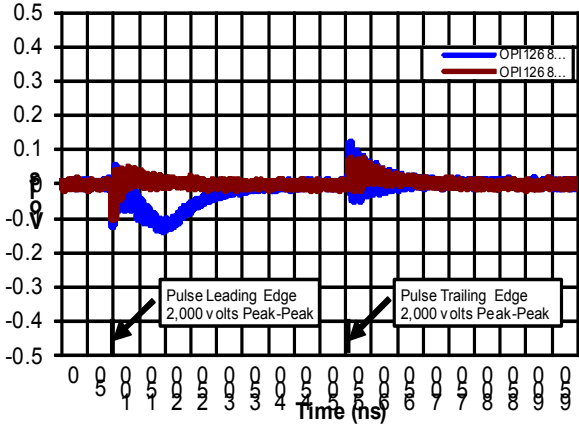

OPI1268 dV/dT Sensor

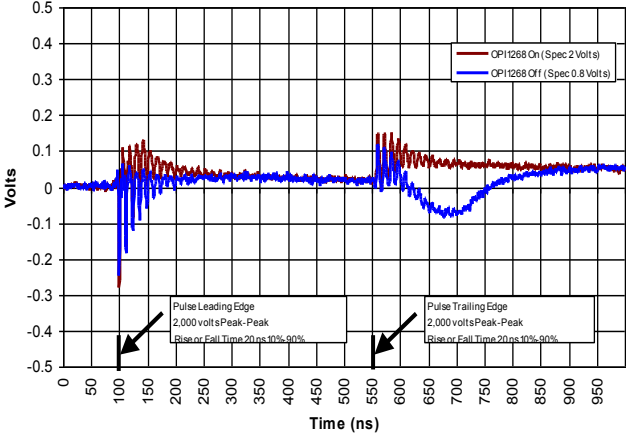

General Note  
TT Electronics reserves the right to make changes in product specification without notice or liability. All information is subject to TT Electronics' own data and is considered accurate at time of going to print.

TT Electronics | OPTEK Technology  
1645 Wallace Drive, Carrollton, TX 75006 | Ph: +1 972 323 2200  
www.ttelectronics.com | sensors@ttelectronics.com

# High Voltage Isolator

OPI1268



Issue	Change Description	Approval	Date
	Initial Release of OPI1266 (July 1996).		July 1996
A	OPI1268 (from PDF Catalog)		07/04
A.1	Combined OPI1266 and OPI1268 and put in new format. Inserted new package drawing.	Trevor Schelp	05/17/07
A.2	Added Note 3 on page 2	Bob Procsal	08/21/07
A.3	Updated Table on page 3	Trevor Schelp	10/01/07
A.4	Separated OPI1266 from the OPI1268	Trevor Schelp	11/27/07
A.5	Reversed tPHL & tPLH times, Removed reference to Input Diode	Trevor Schelp	05/07/2008
B	Change .01 $\mu$ F to 1.0 $\mu$ F on Figure 1. Change Peak Forward Current from 50 mA to 30 mA.	Trevor Schelp	11/11/10
C	Change "2 Mbd transfer rate" to 2MBit/s.	Trevor Schelp	11/23/10
D	Add the UL certification E58730	Cosmin Suci	4/9/15
E	Page 2 Note 1: added "m" to 1.33m W... Page 2 added Note 4: Derate linearly 0.54m W/ $^{\circ}$ C above 25 $^{\circ}$ C Removed (1) on "Input-to-Output Isolation Voltage"	Tom Osborne	
F	Deleted asterisk		

General Note  
TT Electronics reserves the right to make changes in product specification without notice or liability. All information is subject to TT Electronics' own data and is considered accurate at time of going to print.

TT Electronics | OPTEK Technology  
1645 Wallace Drive, Carrollton, TX 75006 | Ph: +1 972 323 2200  
www.ttelectronics.com | sensors@ttelectronics.com