

SPECIFICATION

- Part No. : **AA.171.301111**
- Product Name : MagmaX IP67 GPS/GLONASS/GALILEO/BeiDou
Low Axial Ratio
External Automotive Antenna 3M RG-174
SMA(M)-SAW Filter
- Feature : Magnetic Mount
Dual-pin Patch
Axial Ratio <3 at GPS/GLONASS/GALILEO/BeiDou
RHCP
3M RG-174
SMA(M) Connector
First Tier Automotive TS16949 Approved
Cable and connector customizable
Dimensions: 53mm*50mm*17mm
RoHS Compliant



1. Introduction

The AA.171 Magma Low Axial Ratio Magma magnetic mount external antenna is ideal for robust, covert installations where durability and small size is paramount. It is used in telematics and M2M applications, for example in commercial vehicle installations for fleet management.

Standard cable and connector version is 3 meter RG174 and SMA(M). Cable length and connector type are customizable upon request.

Using a unique specialist feed structure this antenna delivers best in class axial ratio across all GPS, GLONASS, GALILEO and BeiDou bands. Low axial ratio improves accuracy of GNSS system location and leads to quicker lock times. A front-end SAW reduces out-band interference from any nearby wireless transmitters, helping prevent LNA compression and burnout. Manufactured in a dedicated TS16949 facility, PPAP and IMDS documentation are available on request. Low power consumption lengthens device battery life. Adhesive mount version is available on request.

Contact your regional Taoglas office for support.

2. Specification Table

ELECTRICAL			
Center Frequency	1561.098±2.046M Hz	1575.42±1.023 MHz	1602±8 MHz
Antenna Gain	+3.98 dBi(typ.) @zenith XZ-Plane +4.16 dBi(typ.) @zenith YZ-Plane	+1.82 dBi(typ.) @zenith XZ-Plane +2.06 dBi(typ.) @zenith YZ-Plane	+1.10 dBi(typ.) @zenith XZ-Plane +1.43 dBi(typ.) @zenith YZ-Plane
Axial Ratio	1.99 dB(typ) @zenith	1.44 dB(typ) @zenith	2.98 dB(typ) @zenith
Polarization	RHCP		

LNA Electrical Properties			
Frequency	GPS/GALILEO: 1575.42±1.023 MHz GLONASS: 1602±8 MHz Beidou: 1561.098±2.046 MHz		
Impedance	50 Ω		
VSWR	2.0 Max.		
DC input	1.8V (min.)	3.0V (typ.)	5.5V (max.)
LNA Gain	22dB	28dB	30dB
Noise Figure	2.4dB	2.1dB	2.4dB
Power Consumption	3.2mA	7.3mA	8.4mA

MECHANICAL	
Embedded Ceramic Patch Antenna Dimensions	35 x 35 x 6mm
Housing Dimensions	53*50*17mm
Housing Material	ABS
Cable	3M RG174 (fully customizable)
Connector	SMA(M) (fully customizable)
Waterproof	IP67
Weight	92g
Magnetic Pull Force	Pull horizontal max pull force(kgf) : 0.52 Pull vertical max pull force(kgf) : 0.48

ENVIRONMENTAL	
Operation Temperature	-40°C ~ +85°C
Storage Temperature	-40°C ~ +90°C

3. Antenna Block Diagram

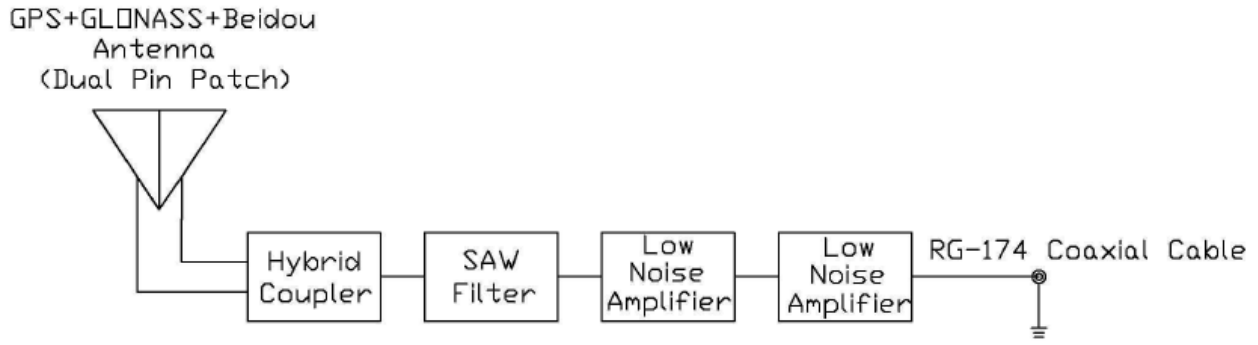

4. Antenna Characteristics

4.1 Return Loss

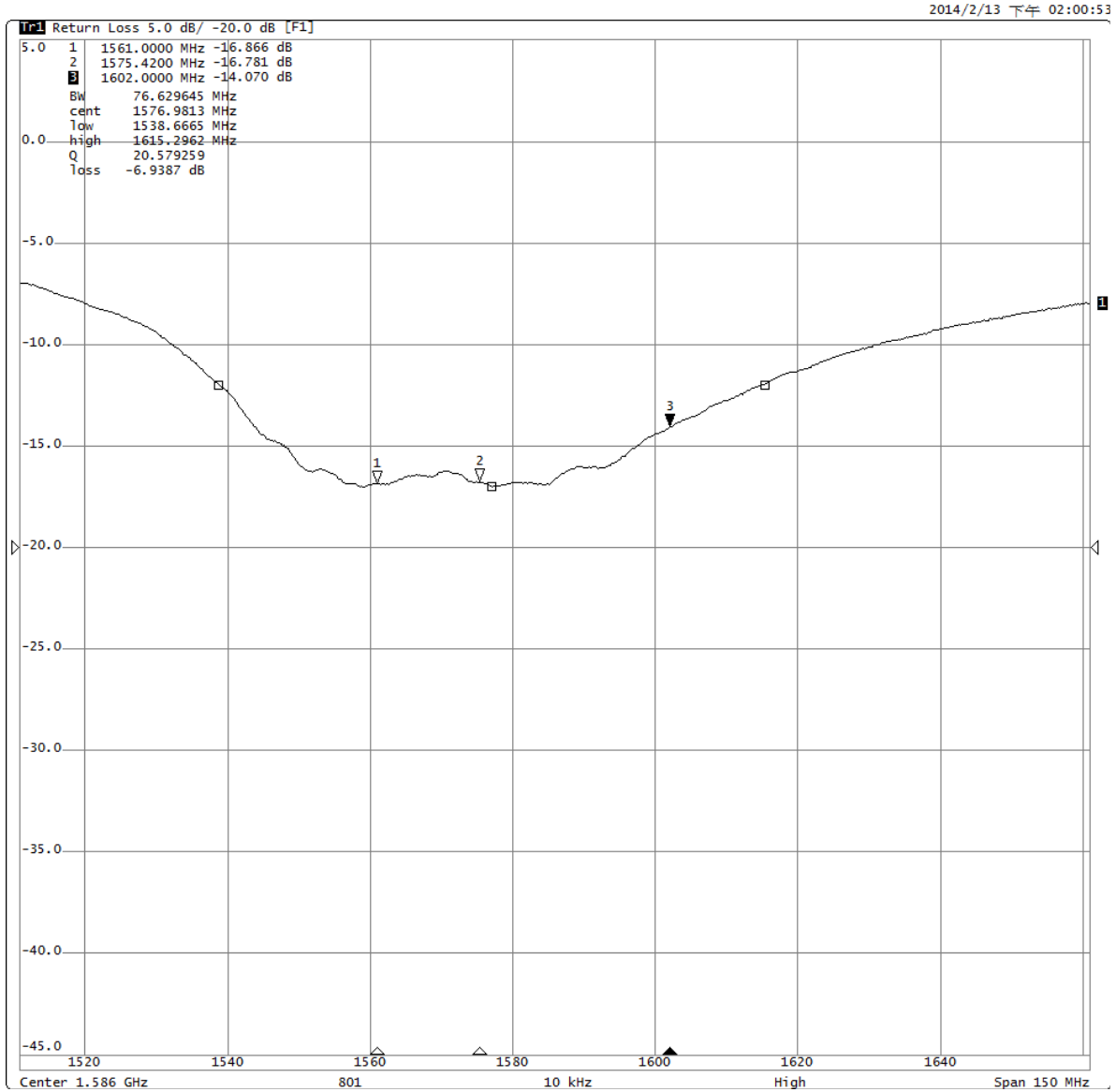

Frequency (MHz)	Return Loss
1561 MHz	-16.78dB
1575 MHz	-16.88dB
1602 MHz	-14.09dB

4.2 VSWR

2014/2/13 下午 02:01:02

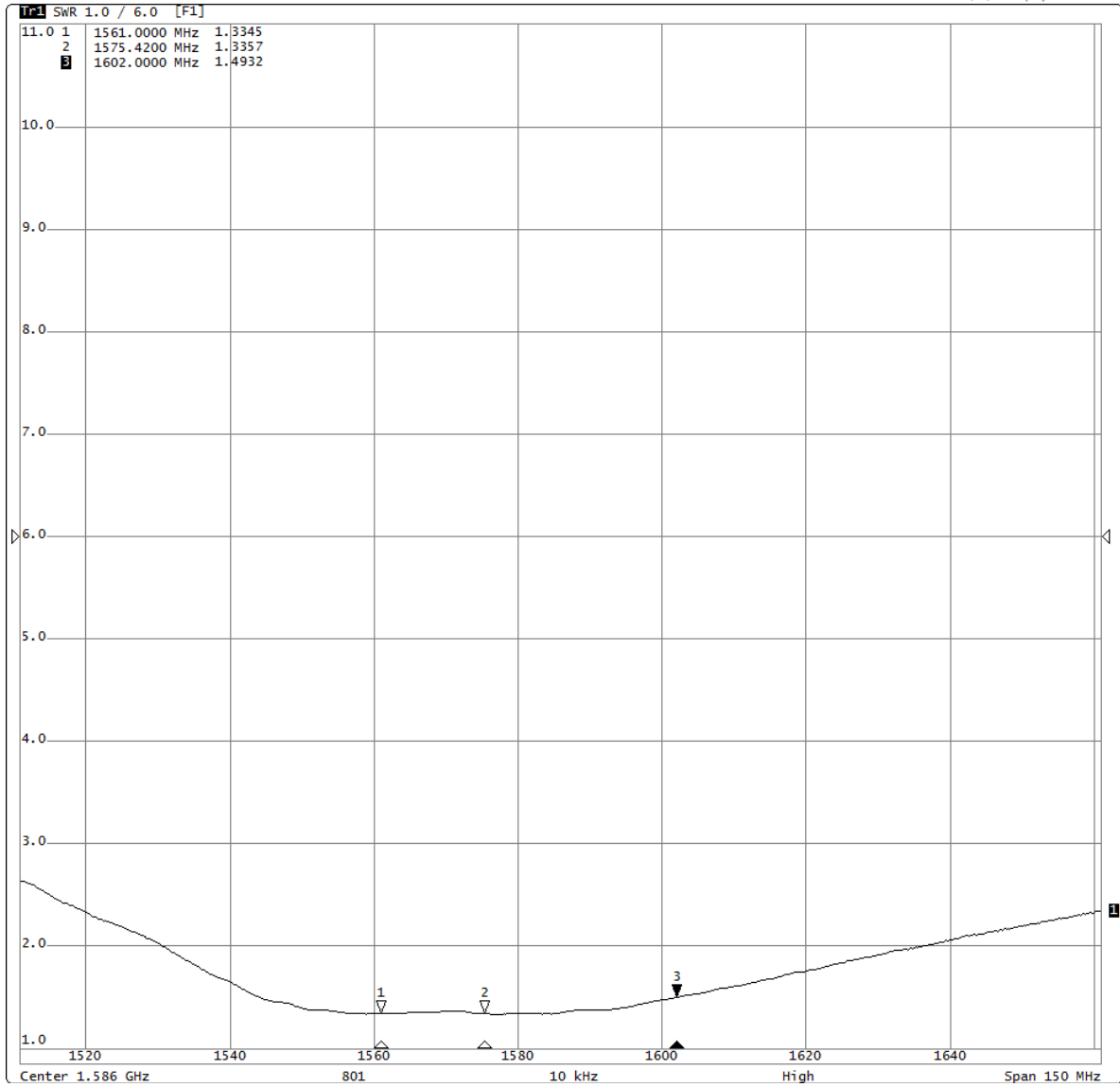

Frequency (MHz)	VSWR
1561 MHz	1.33
1575 MHz	1.33
1602 MHz	1.49

4.3 Impedance

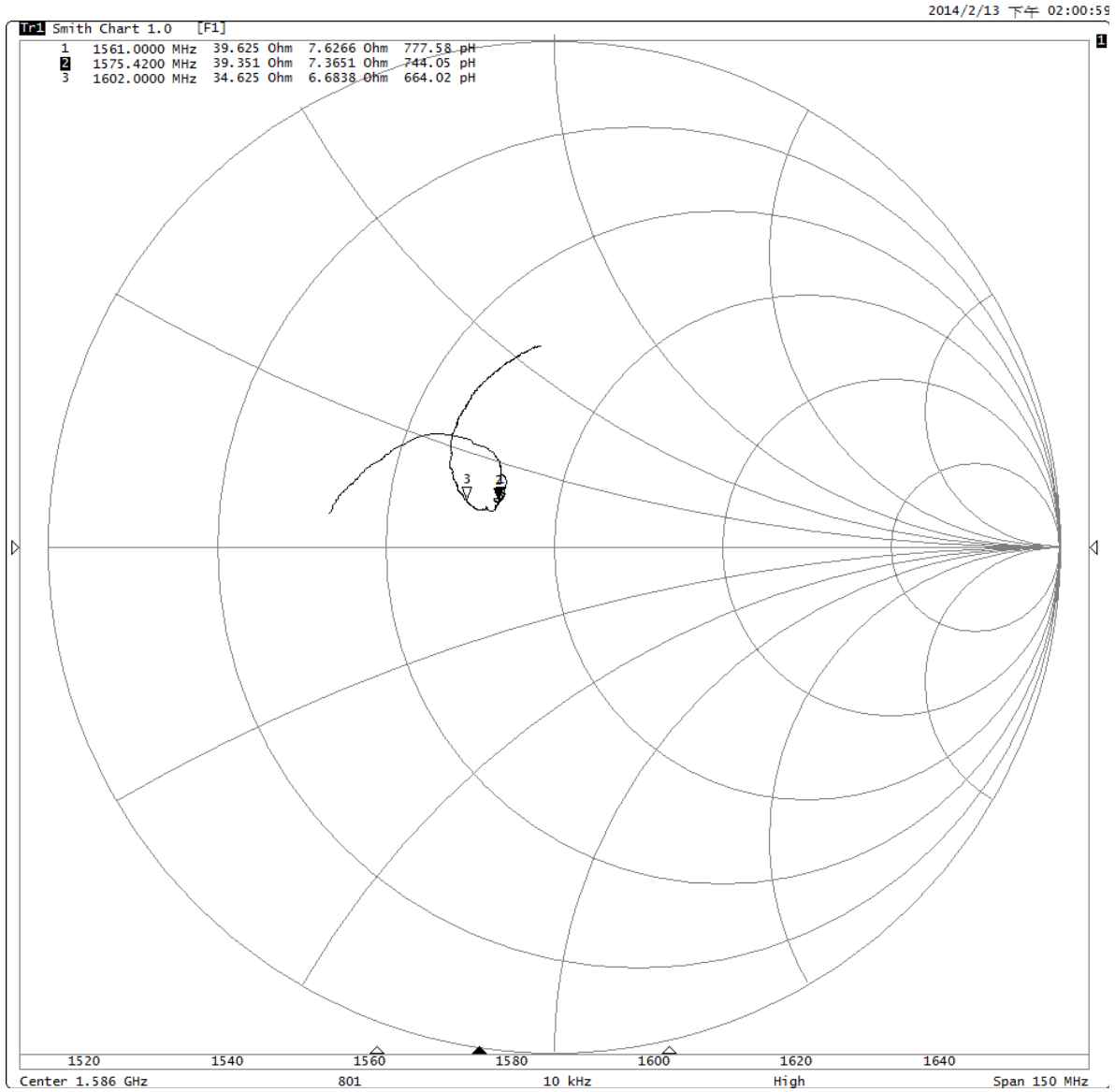

Frequency (MHz)	Impedance
1561 MHz	39.54 + j07.70
1575 MHz	39.36 + j07.32
1602 MHz	34.58 - j06.59

4.4 Radiation Pattern

XZ-Plane

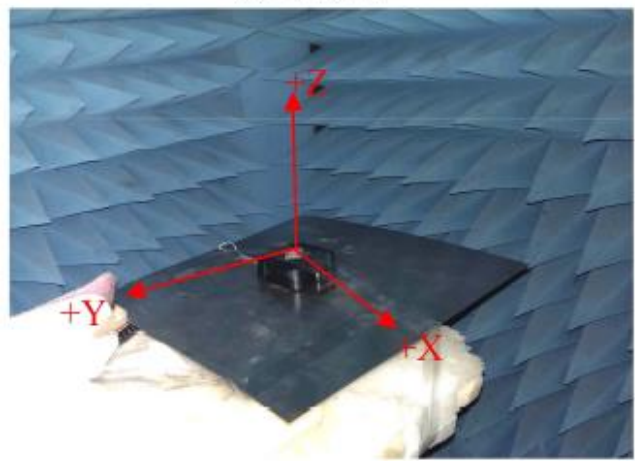

YZ-Plane

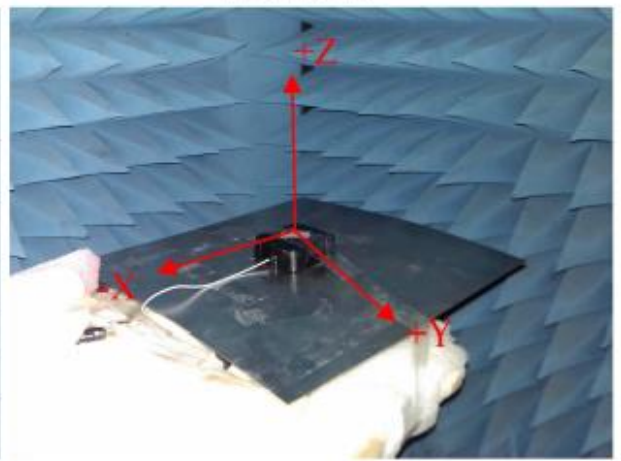

4.4.1 1561MHz

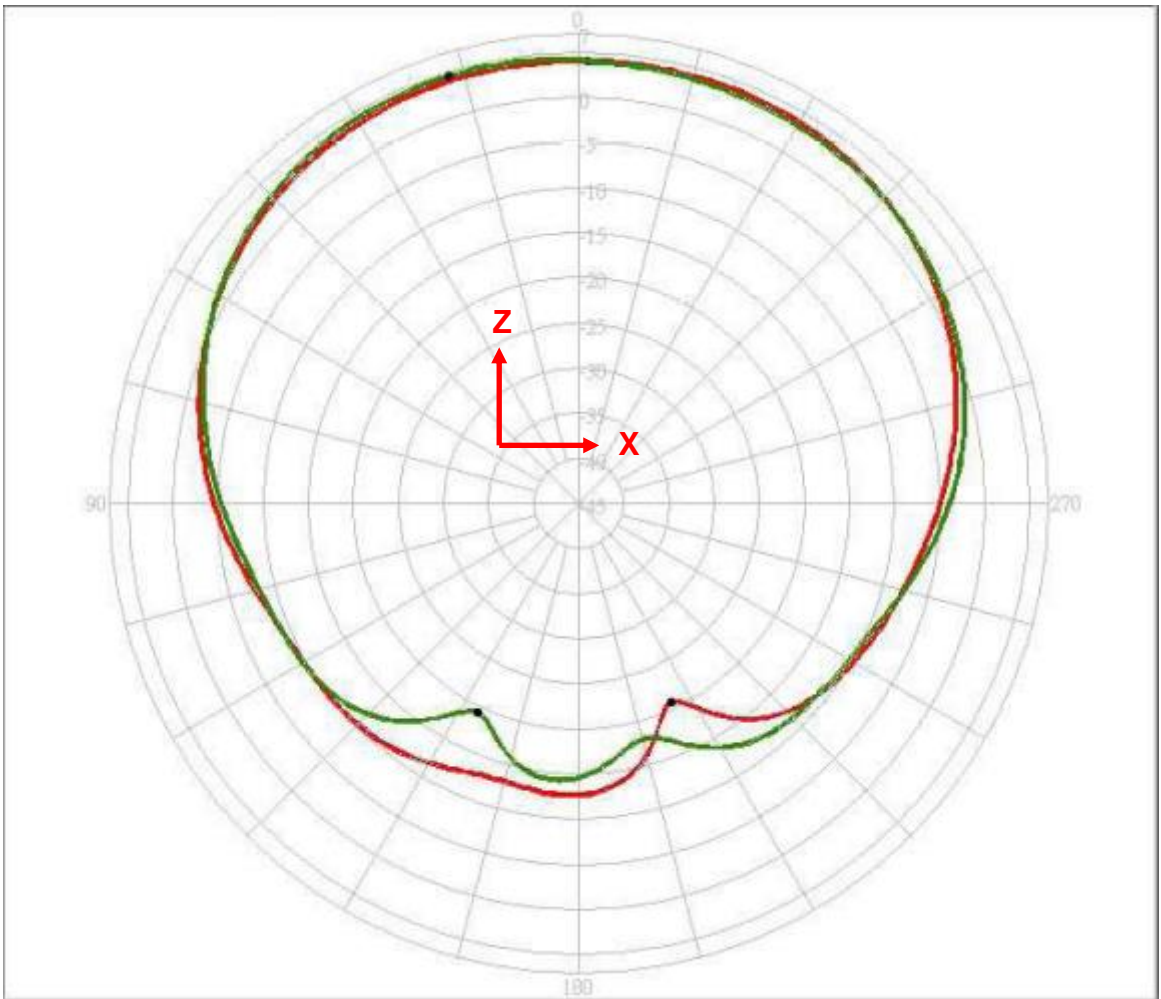

1561MHZ	XZ-Plane	YZ-Plane
At Zenith	3.98 dBi	4.16 dBi

4.4.2 1575.42MHz

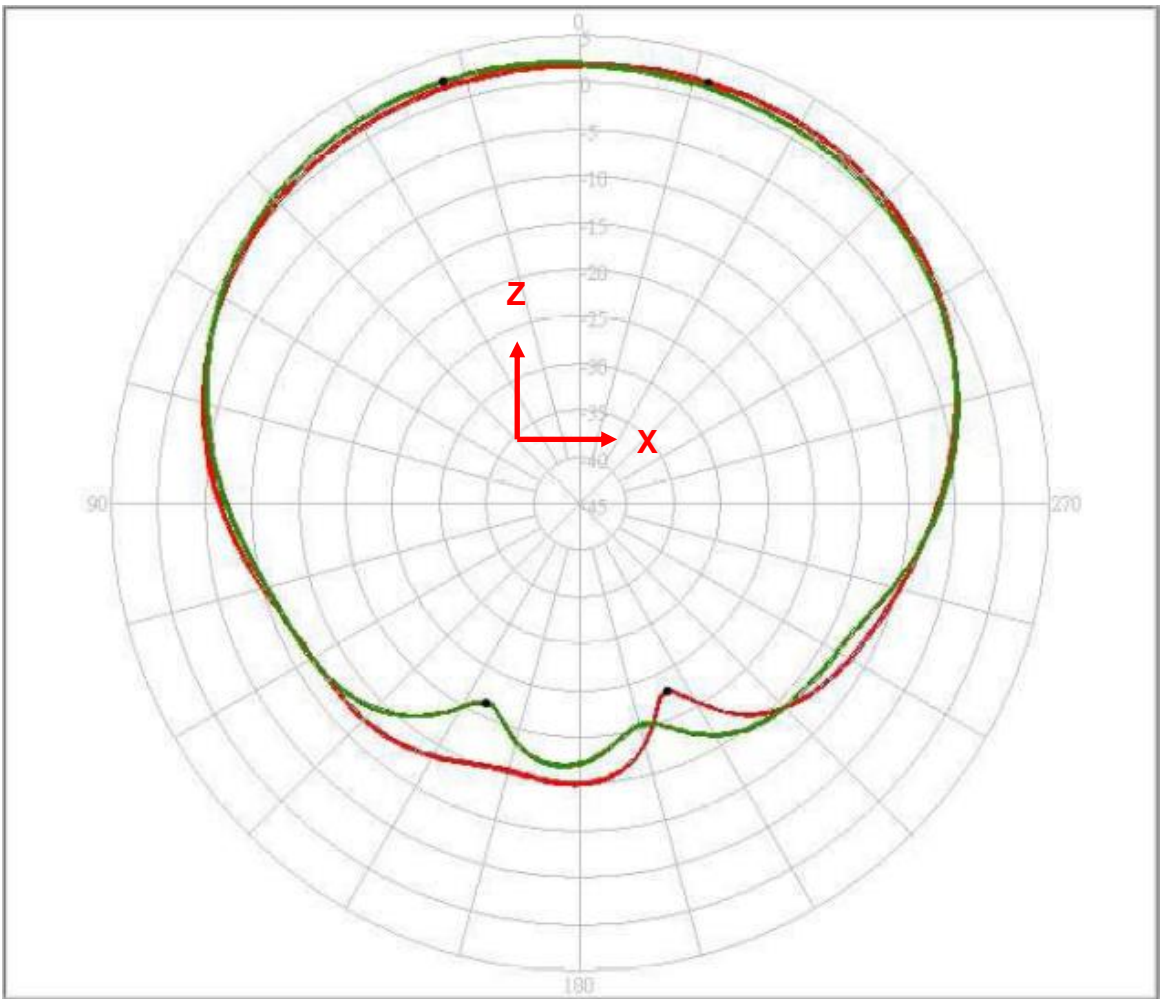

1575.42MHZ	XZ-Plane	YZ-Plane
At Zenith	1.82 dBi	2.06 dBi

4.4.3 1602MHz

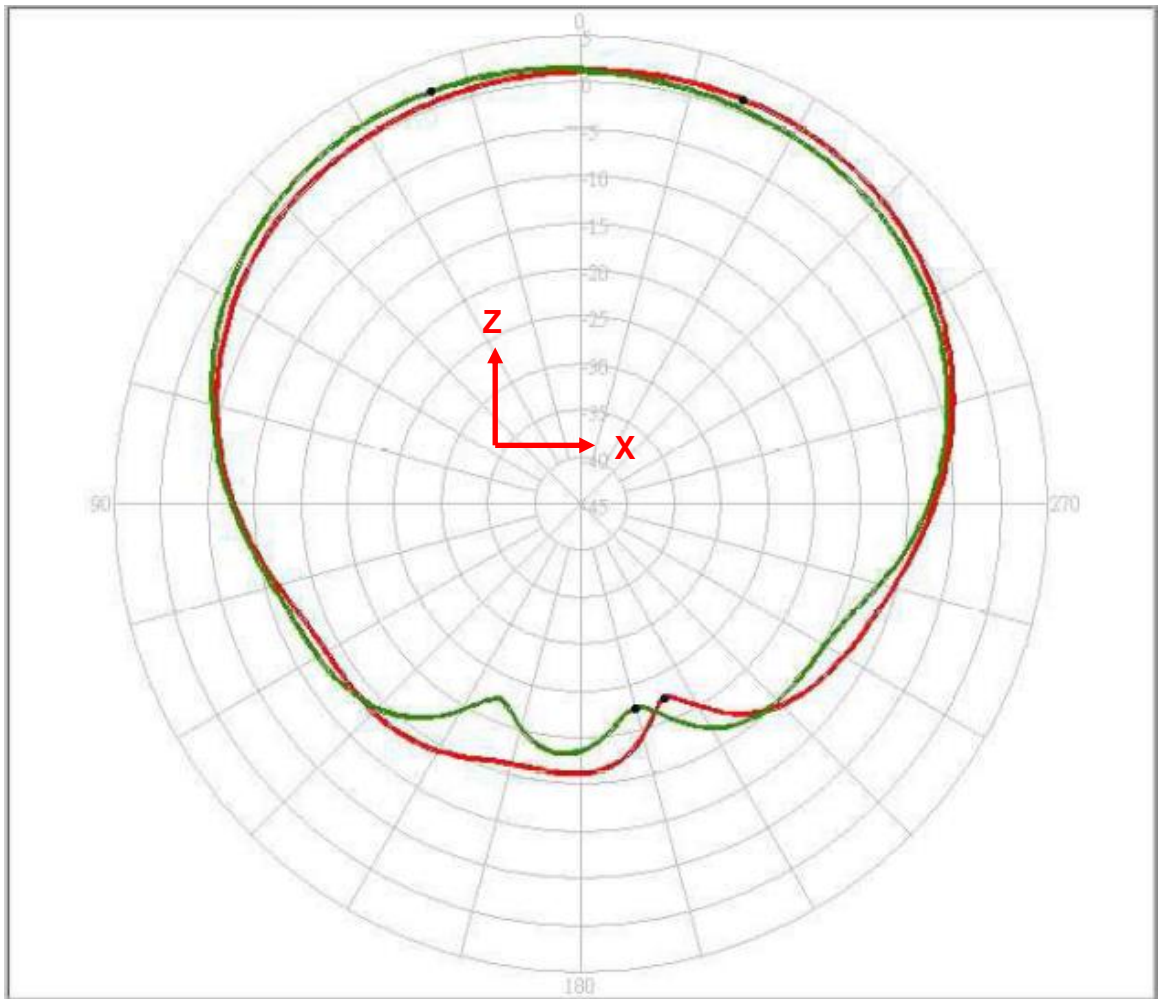

1602MHZ	XZ-Plane	YZ-Plane
At Zenith	1.10 dBi	1.43 dBi

4.5 Axial Ratio Pattern (Spin Dipole Method)

4.5.1 1561MHz

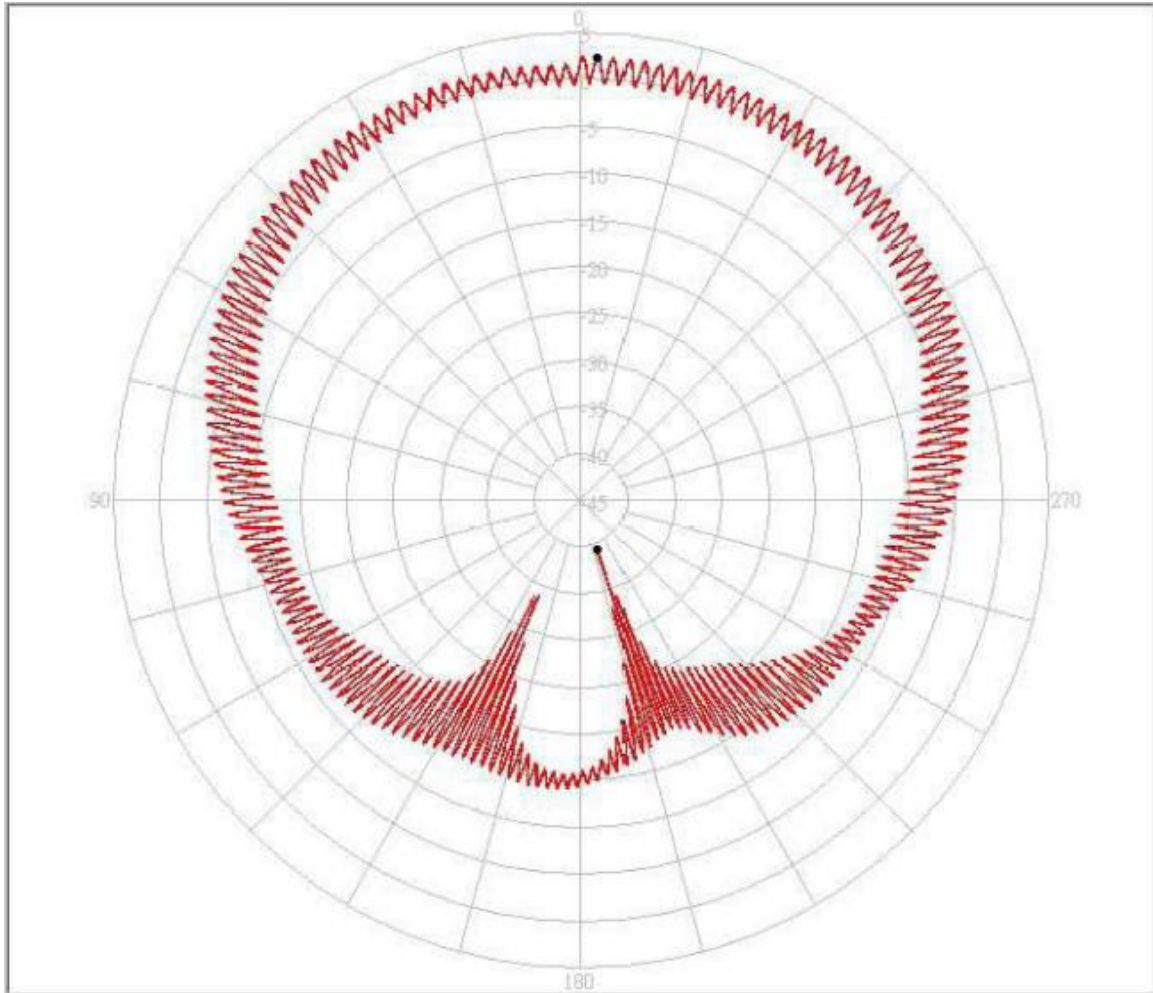

1561MHZ	Axial Ratio
At Zenith	1.99 dBi

4.5.2 1575.42MHz

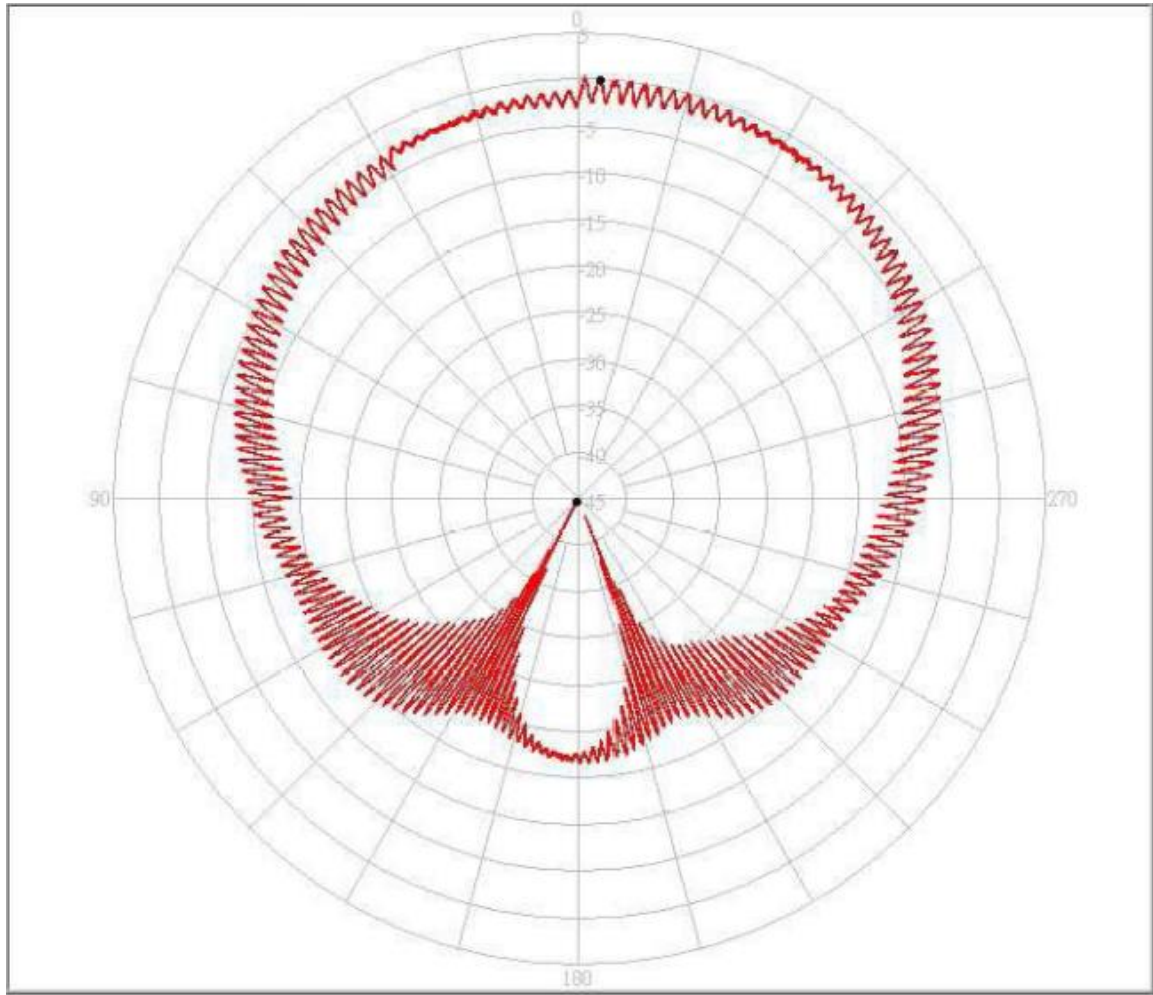

1575.42MHZ	Axial Ratio
At Zenith	1.44 dBi

4.5.3 1602MHz

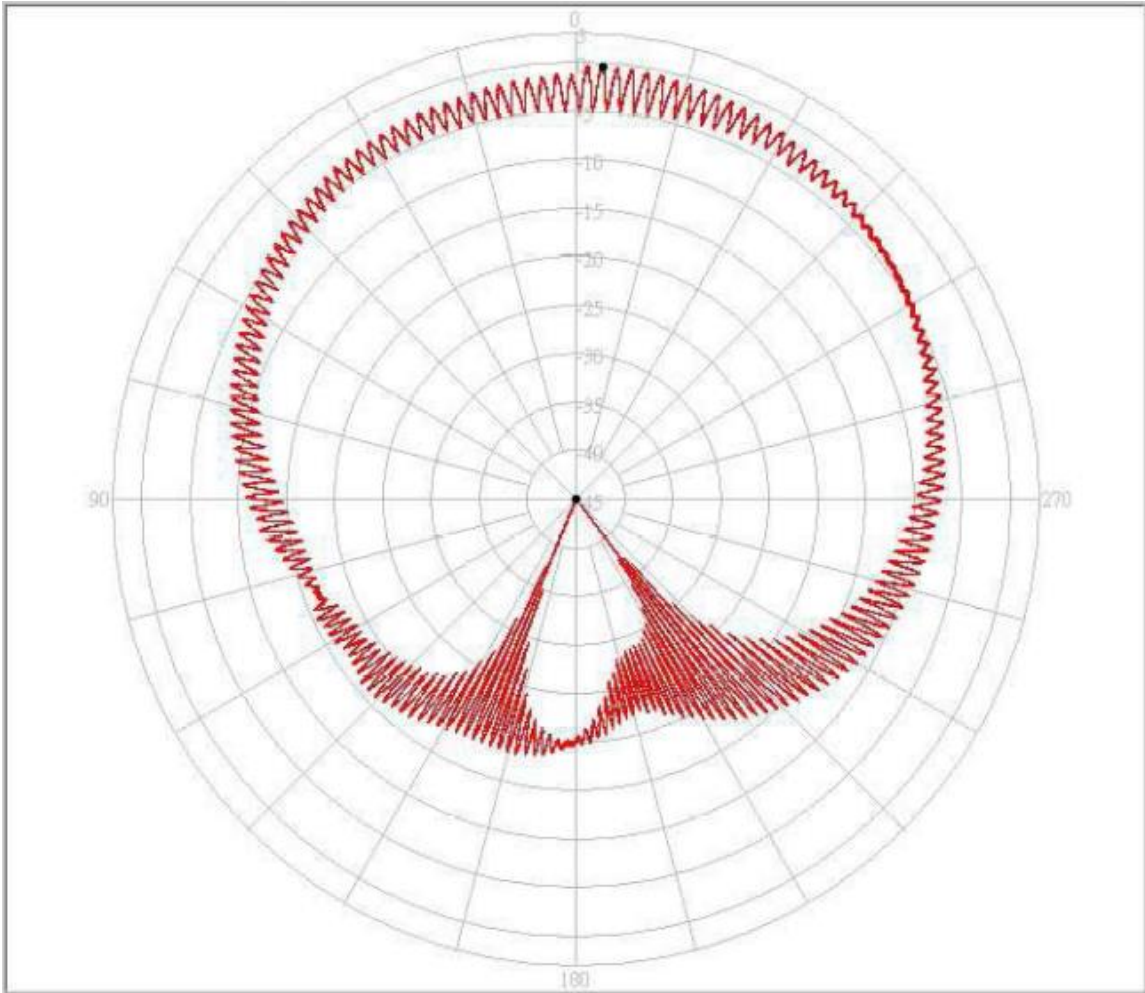

1602MHZ	Axial Ratio
At Zenith	2.98 dBi

5. GPS/GLONASS/GALILEO/Beidou LNA

5.1 LNA Gain and Output VSWR@3.0V

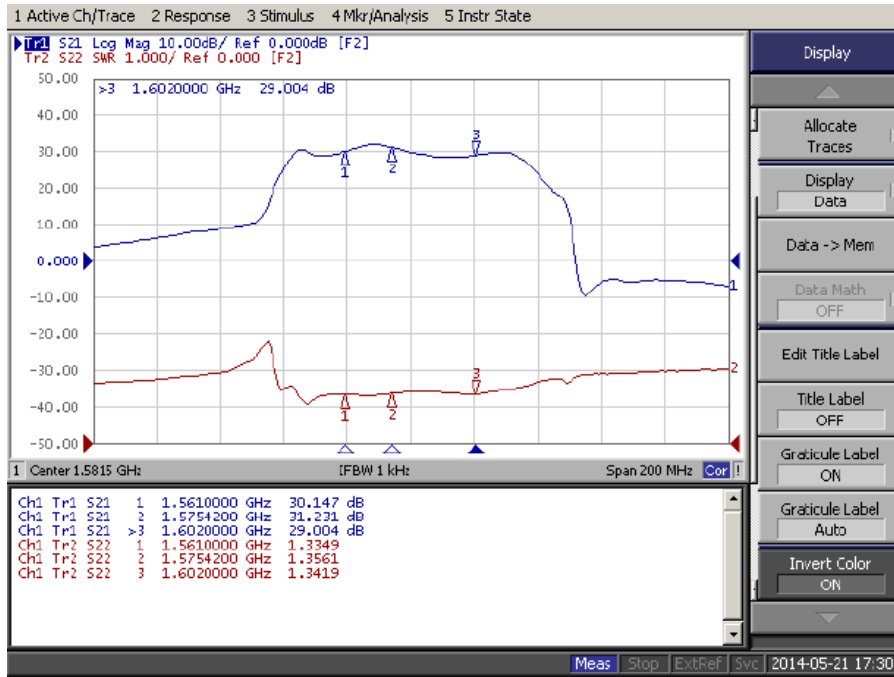

5.2 LNA Noise@3.0V

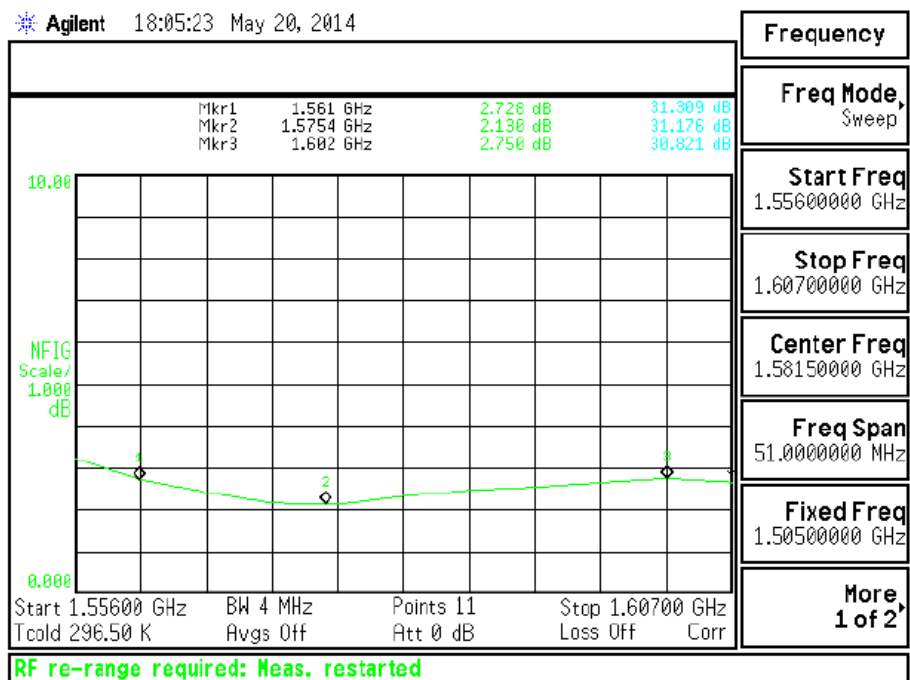

6. Magnetic Pull Force (kilogram – force (kgf))

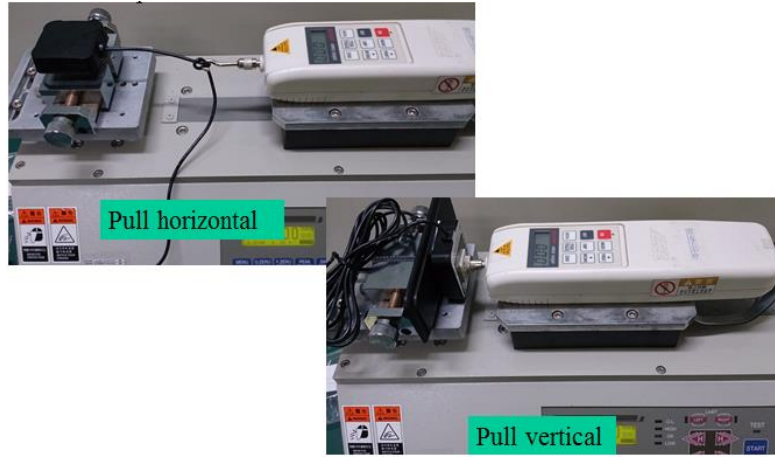

Horizontal Pull Force Breakdown: 0.52kgf

Distance(mm)	0.5	1.0	2.0	3.0	4.0	5.0	6.0	7.0	8.0	9.0
Pulling force(Kgf)	0	0	0.18	0.31	0.3	0.3	0.3	0.3	0.3	0.3
Distance(mm)	10.0	11.0	12.0	13.0	14.0	15.0	16.0	16.3	17.0	18.0
Pulling force(Kgf)	0.3	0.27	0.24	0.29	0.3	0.44	0.52	0.54	0.42	0.37

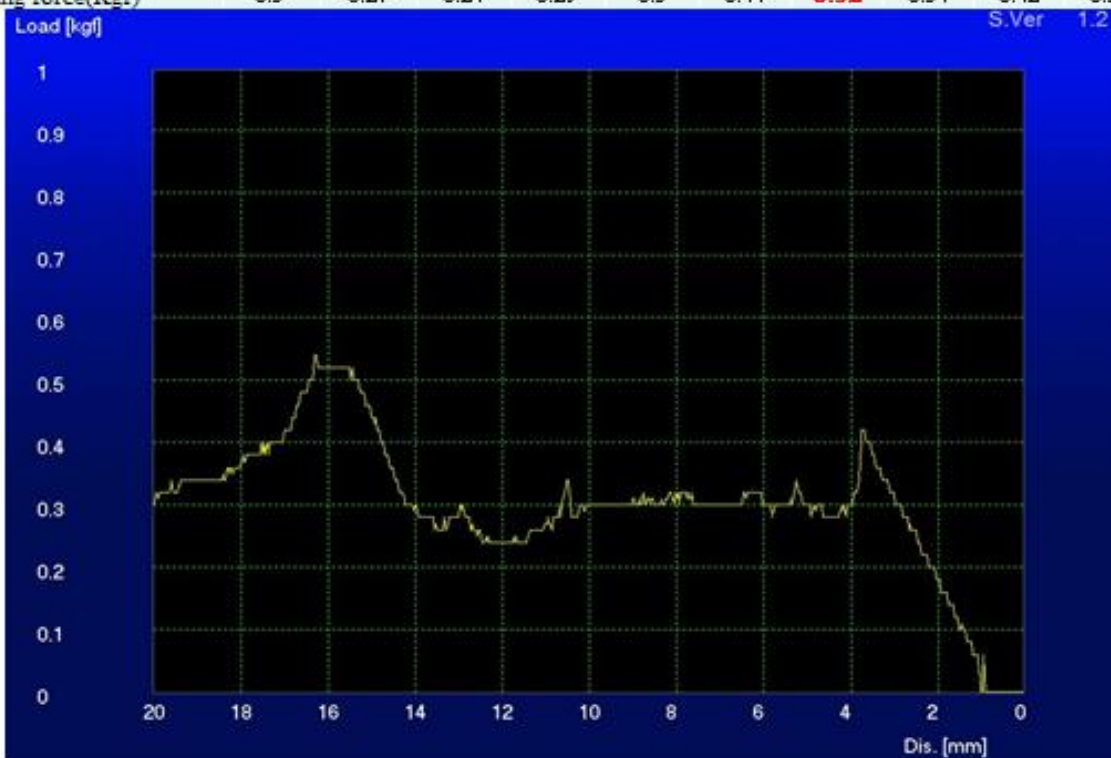

Vertical Pull Force Breakdown: 1.23 kgf

Distance(mm)	0.5	1.0	1.5	2.0	2.5	3.0	3.5	4.0	4.5	5.0
Pulling force (Kgf)	0.96	1.07	1.23	0.84	0.55	0.42	0.38	0.35	0.34	0.32

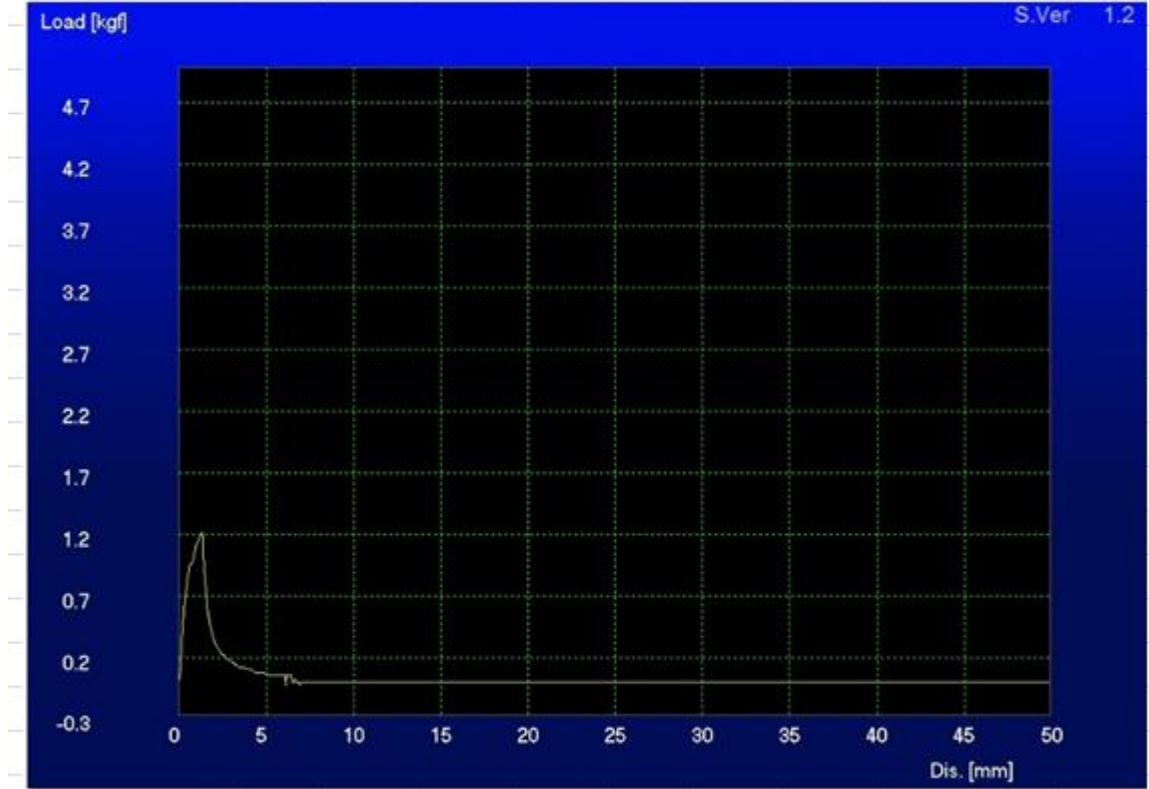

7. Mechanical Drawing

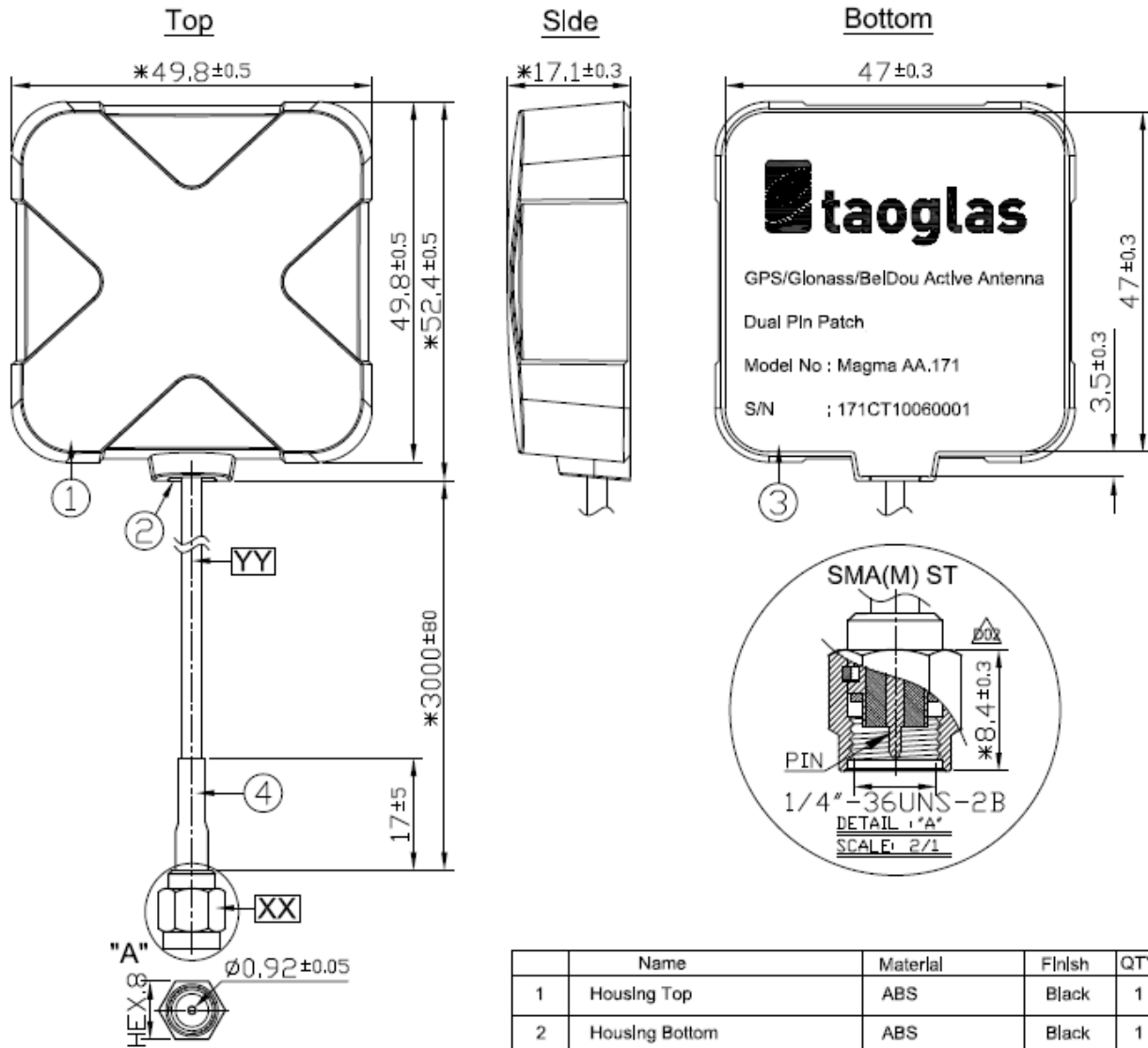

8. Packaging

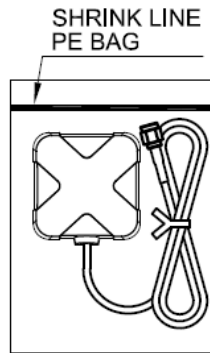

1 piece per bag
100 units per carton

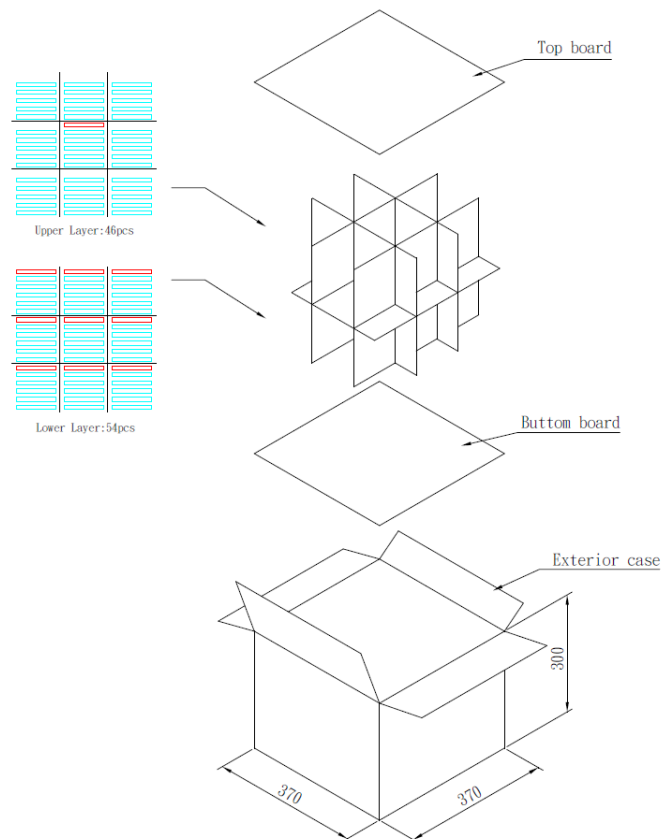

Taoglas makes no warranties based on the accuracy or completeness of the contents of this document and reserves the right to make changes to specifications and product descriptions at any time without notice. Taoglas reserves all rights to this document and the information contained herein.

Reproduction, use or disclosure to third parties without express permission is strictly prohibited.

Copyright © Taoglas Ltd.