

THIS DRAWING IS UNPUBLISHED. RELEASED FOR PUBLICATION
 © COPYRIGHT BY TYCO ELECTRONICS CORPORATION. ALL RIGHTS RESERVED.

LOC		DIST		REVISIONS			
P	LTR	DESCRIPTION		DATE	DWN	APVD	
	H	REVISED PER EC 0512-0273-05		19SEP05	JDP	DD	

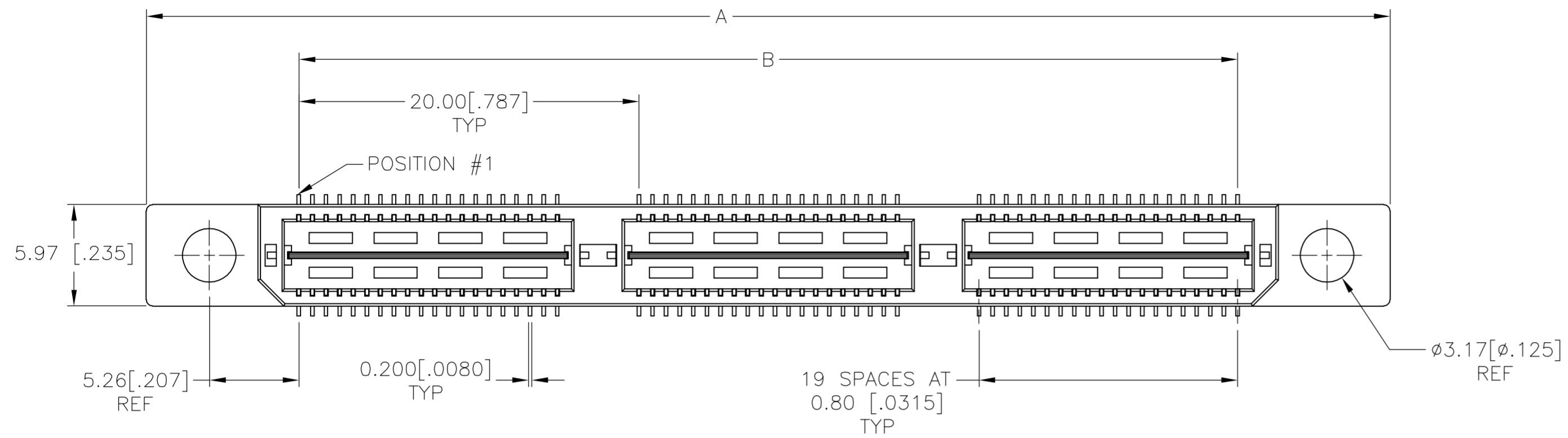

- 1 HOUSING: LCP, BLACK.
CONTACT & GROUND PLANE: PHOS BRONZE.
- 2 CONTACT PLATING: SELECT GOLD FLASH.
- 3 FOR STANDARD APPLICATIONS, ORIENTATION HOLE TO BE $\phi 1.02$ [$\phi .040$].

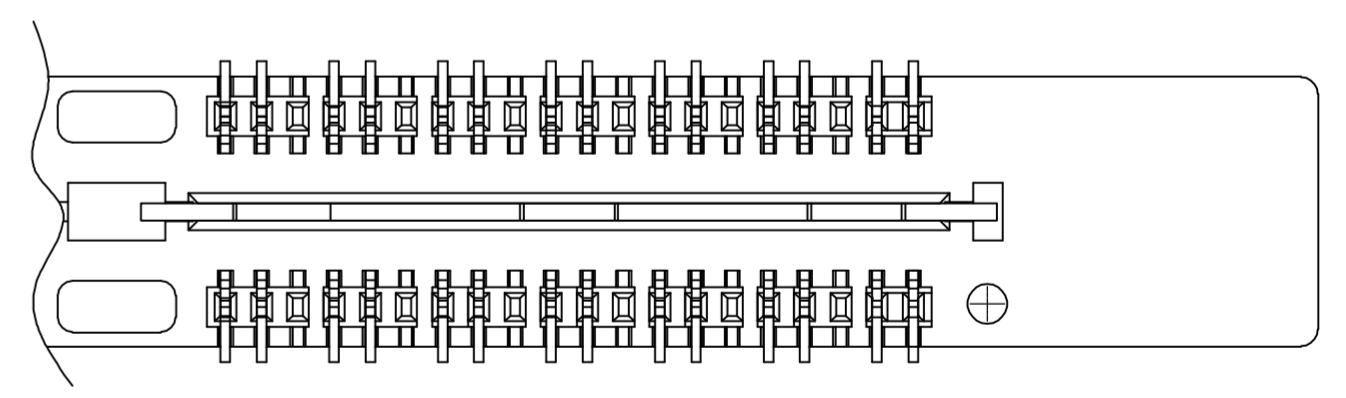
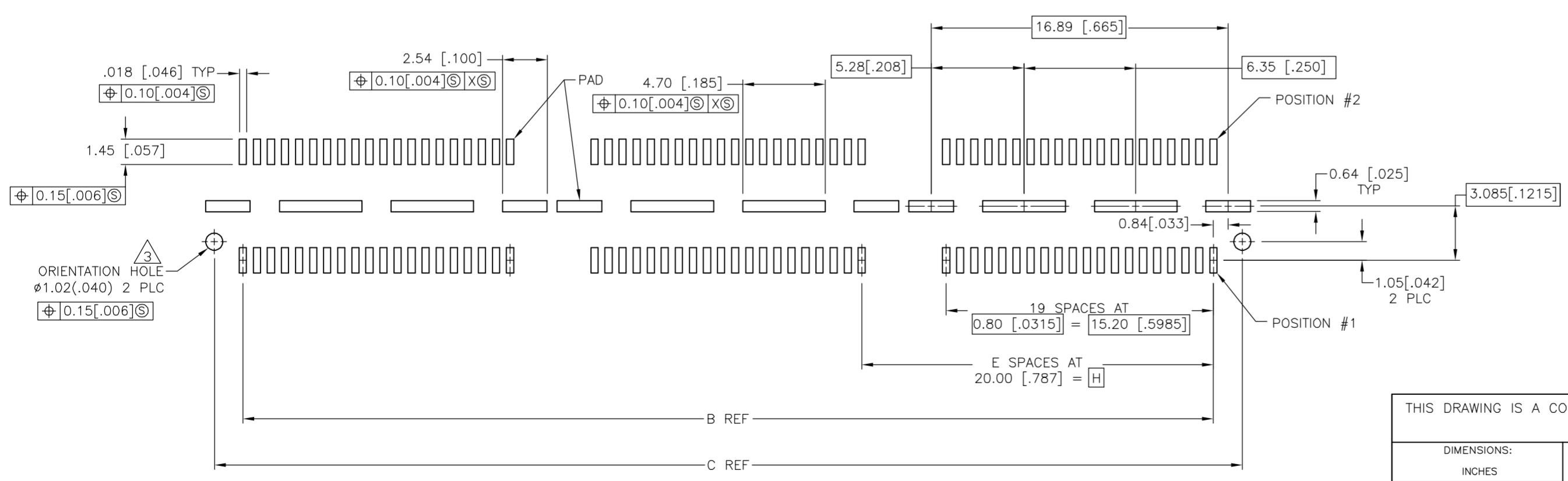
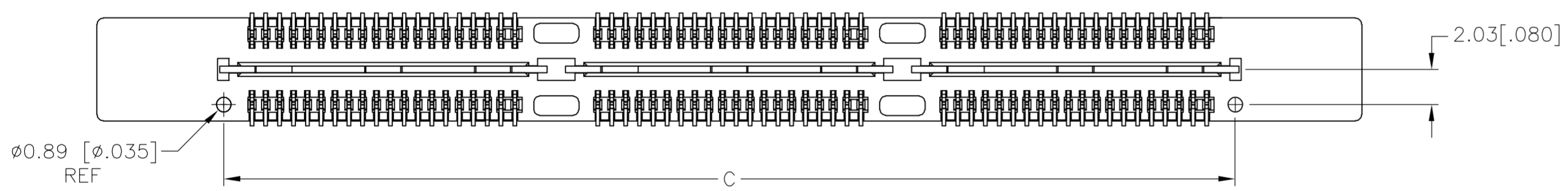
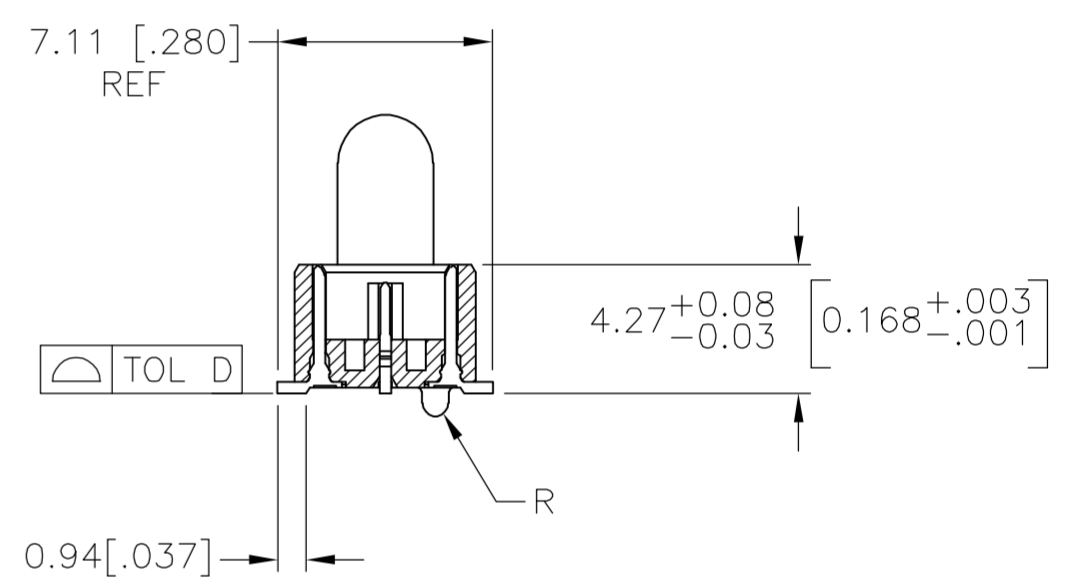
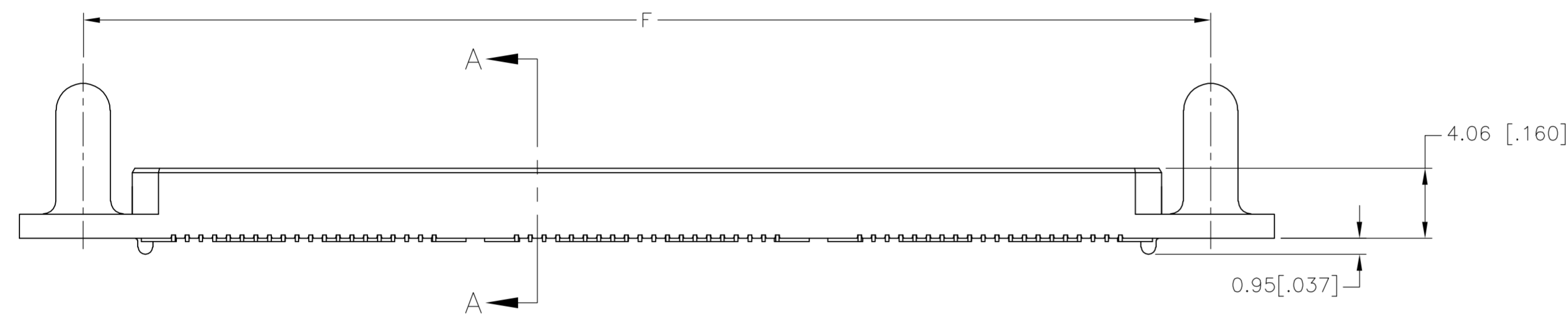

RECOMMENDED PC BOARD LAYOUT
 (VIEWED FROM CONNECTOR SIDE)

THIS DRAWING IS A CONTROLLED DOCUMENT.		DWN B.CARBO 26FEB03	tyco Electronics	Tyco Electronics Corporation Harrisburg, PA 17105-3608	
DIMENSIONS: INCHES		CHK D.DIXON 26FEB03		NAME	
TOLERANCES UNLESS OTHERWISE SPECIFIED:		APVD D.DIXON 26FEB03	PLUG ASSEMBLY, 5.0MM [.197] VERTICAL, 0.80MM CL, MICTOR SB		
0 PLC ± -		PRODUCT SPEC	SIZE A2	CAGE CODE 00779	DRAWING NO C=1658072
1 PLC ± 0.3[.01]		APPLICATION SPEC	WEIGHT -	SCALE 3:1	SHEET 1 of 2
2 PLC ± 0.13[.005]			CUSTOMER DRAWING	RESTRICTED TO -	REV H
3 PLC ± 0.05[.0020]					
4 PLC ± -					
ANGLES ± 2'					
FINISH					

THIS DRAWING IS UNPUBLISHED. RELEASED FOR PUBLICATION
 © COPYRIGHT BY TYCO ELECTRONICS CORPORATION. ALL RIGHTS RESERVED.

LOC	DIST	REVISIONS					
AD	00	P	LTR	DESCRIPTION	DATE	DWN	APVD
		-		SEE SHEET 1			

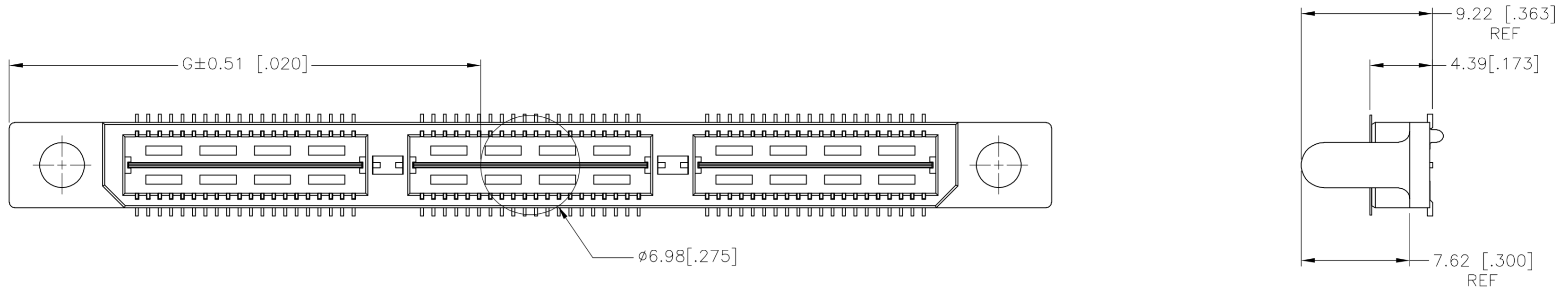

20.00(.7874)	23.06(.908)	45.72(1.800)	1	0.102(.0040)	38.48(1.515)	35.20(1.386)	53.14(2.092)	YES	POCKET TAPE	YES	56	7-1658072-2	
0(.000)	13.08(.515)	25.72(1.013)	0	0.102(.0040)	18.49(.728)	15.20(.598)	33.15(1.305)	YES	POCKET TAPE	YES	28	7-1658072-1	
20.00(.7874)	23.06(.908)	45.72(1.800)	1	0.102(.0040)	38.48(1.515)	35.20(1.386)	53.14(2.092)	YES	POCKET TAPE	NO	80	6-1658072-2	
0(.000)	13.08(.515)	25.72(1.013)	0	0.102(.0040)	18.49(.728)	15.20(.598)	33.15(1.305)	YES	POCKET TAPE	NO	40	6-1658072-1	
20.00(.7874)	-	45.72(1.800)	1	0.102(.0040)	38.48(1.515)	35.20(1.386)	53.14(2.092)	NO	POCKET TAPE	YES	56	5-1658072-2	
0(.000)	-	25.72(1.013)	0	0.102(.0040)	18.49(.728)	15.20(.598)	33.15(1.305)	NO	POCKET TAPE	YES	28	5-1658072-1	
20.00(.7874)	-	45.72(1.800)	1	0.102(.0040)	38.48(1.515)	35.20(1.386)	53.14(2.092)	NO	POCKET TAPE	NO	80	4-1658072-2	
0(.000)	-	25.72(1.013)	0	0.102(.0040)	18.49(.728)	15.20(.598)	33.15(1.305)	NO	POCKET TAPE	NO	40	4-1658072-1	
80.00(3.150)	53.07(2.090)	105.72(4.162)	4	0.152(.0060)	98.50(3.878)	95.20(3.748)	113.15(4.454)	YES	TRAY	YES	140	3-1658072-5	
60.00(2.362)	43.08(1.696)	85.72(3.375)	3	0.152(.0060)	78.49(3.090)	75.20(2.961)	93.14(3.667)	YES	TRAY	YES	112	3-1658072-4	
40.00(1.575)	33.07(1.302)	65.72(2.587)	2	0.152(.0060)	58.50(2.303)	55.20(2.173)	73.15(2.88)	YES	TRAY	YES	84	3-1658072-3	
20.00(.7874)	23.06(.908)	45.72(1.800)	1	0.102(.0040)	38.48(1.515)	35.20(1.386)	53.14(2.092)	YES	TRAY	YES	56	3-1658072-2	
0(.000)	13.08(.515)	25.72(1.013)	0	0.102(.0040)	18.49(.728)	15.20(.598)	33.15(1.305)	YES	TRAY	YES	28	3-1658072-1	
80.00(3.150)	53.07(2.090)	105.72(4.162)	4	0.152(.0060)	98.50(3.878)	95.20(3.748)	113.15(4.454)	YES	TRAY	NO	200	2-1658072-5	
60.00(2.362)	43.08(1.696)	85.72(3.375)	3	0.152(.0060)	78.49(3.090)	75.20(2.961)	93.14(3.667)	YES	TRAY	NO	160	2-1658072-4	
40.00(1.575)	33.07(1.302)	65.72(2.587)	2	0.152(.0060)	58.50(2.303)	55.20(2.173)	73.15(2.88)	YES	TRAY	NO	120	2-1658072-3	
20.00(.7874)	23.06(.908)	45.72(1.800)	1	0.102(.0040)	38.48(1.515)	35.20(1.386)	53.14(2.092)	YES	TRAY	NO	80	2-1658072-2	
0(.000)	13.08(.515)	25.72(1.013)	0	0.102(.0040)	18.49(.728)	15.20(.598)	33.15(1.305)	YES	TRAY	NO	40	2-1658072-1	
80.00(3.150)	-	105.72(4.162)	4	0.152(.0060)	98.50(3.878)	95.20(3.748)	113.15(4.454)	NO	TRAY	YES	140	1-1658072-5	
60.00(2.362)	-	85.72(3.375)	3	0.152(.0060)	78.49(3.090)	75.20(2.961)	93.14(3.667)	NO	TRAY	YES	112	1-1658072-4	
40.00(1.575)	-	65.72(2.587)	2	0.152(.0060)	58.50(2.303)	55.20(2.173)	73.15(2.88)	NO	TRAY	YES	84	1-1658072-3	
20.00(.7874)	-	45.72(1.800)	1	0.102(.0040)	38.48(1.515)	35.20(1.386)	53.14(2.092)	NO	TRAY	YES	56	1-1658072-2	
0(.000)	-	25.72(1.013)	0	0.102(.0040)	18.49(.728)	15.20(.598)	33.15(1.305)	NO	TRAY	YES	28	1-1658072-1	
80.00(3.150)	-	105.72(4.162)	4	0.152(.0060)	98.50(3.878)	95.20(3.748)	113.15(4.454)	NO	TRAY	NO	200	1658072-5	
60.00(2.362)	-	85.72(3.375)	3	0.152(.0060)	78.49(3.090)	75.20(2.961)	93.14(3.667)	NO	TRAY	NO	160	1658072-4	
40.00(1.575)	-	65.72(2.587)	2	0.152(.0060)	58.50(2.303)	55.20(2.173)	73.15(2.88)	NO	TRAY	NO	120	1658072-3	
20.00(.7874)	-	45.72(1.800)	1	0.102(.0040)	38.48(1.515)	35.20(1.386)	53.14(2.092)	NO	TRAY	NO	80	1658072-2	
0(.000)	-	25.72(1.013)	0	0.102(.0040)	18.49(.728)	15.20(.598)	33.15(1.305)	NO	TRAY	NO	40	1658072-1	
H	G	F	E	D	C	B	A	POLYIMIDE FILM PAD ▲		PACKAGING TYPE	DIFF. PAIR	NO OF POS	PART NUMBER

THIS DRAWING IS A CONTROLLED DOCUMENT.

DWN	B. CARRO	26FEB03
CHK	D. DIXON	26FEB03
APVD	D. DIXON	26FEB03
PRODUCT SPEC	-	-
APPLICATION SPEC	-	-
WEIGHT	-	-
CUSTOMER DRAWING	SCALE 3:1 SHEET 2 of 2 REV H	

tyco Electronics Tyco Electronics Corporation
Harrisburg, PA 17105-3608

NAME: PLUG ASSEMBLY, 5.0MM [.197] VERTICAL, 0.80MM CL, MICTOR SB

SIZE: A2 CAGE CODE: 00779 DRAWING NO: C=1658072 RESTRICTED TO: -