

LTM4651 EN55022B Compliant 58V, 24W Inverting-Output DC/DC μ Module Regulator

DESCRIPTION

Demonstration circuit 2328A is an inverting buck-boost converter with 12V to 34V input voltage, -24V output voltage and max 2A output current capability, which features the LTM[®]4651Y. The LTM4651 is an ultralow noise, 58V, 24W inverting-topology DC/DC μ Module regulator. It is designed to meet the radiated emissions requirement of EN55022B. A switching frequency range of 250kHz to

3MHz is supported and the module can synchronize to an external clock. The LTM4651 data sheet must be read in conjunction with this demo manual prior to working on or modifying demo circuit DC2328A.

Design files for this circuit board are available at <http://www.linear.com/demo/DC2328A>

LT, LTC, LTM, Linear Technology and the Linear logo are registered trademarks of Analog Devices, Inc. All other trademarks are the property of their respective owners.

PERFORMANCE SUMMARY Specifications are at T_A = 25°C

PARAMETER	CONDITIONS	VALUE
Input Voltage Range		12V to 34V
Output Voltage, V _{OUT}	12V _{IN} , 0A to 1A; 24V _{IN} , 0A to 2A; 34V _{IN} , 0A to 2A	-24V \pm 2%
Maximum Output Current, I _{OUT}	Derating for Certain V _{IN} and Thermal Conditions	2A
Default Operating Frequency		1.2MHz
Efficiency	24V _{IN} , -24V _{OUT} , 2A	87.5%

BOARD PHOTO

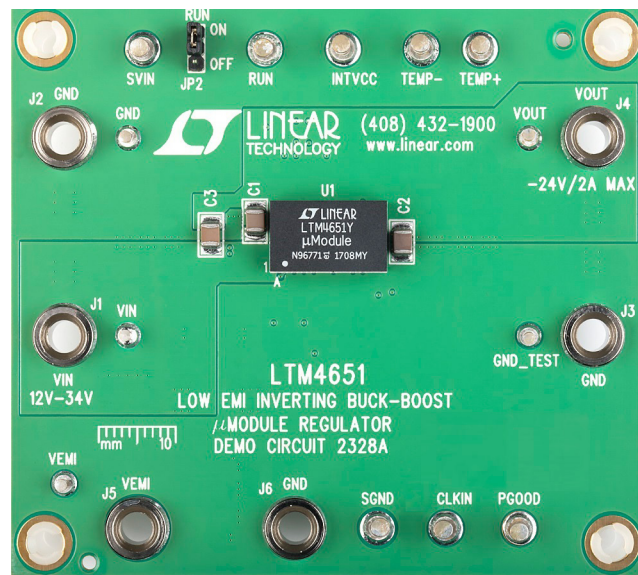

DC2328A Top View

QUICK START PROCEDURE

Demonstration circuit 2328A is easy to set up to evaluate the performance of the LTM4651Y. Refer to Figure 1 for the proper measurement equipment setup and follow the procedure below:

1. With power off, connect the input power supply to V_{IN} (12V to 34V) and GND (input return).
2. Connect the -24V output load between V_{OUT} (-) and GND (+) (Initial load: no load).
3. Connect the DVMs to the input and output. Set the default jumper position, JP2: ON.
4. Turn on the input power supply and check for the proper output voltages. V_{OUT} should be $-24V \pm 2\%$.

5. Once the proper output voltages are established, adjust the loads within the operating range and observe the output voltage regulation, ripple voltage and other parameters.

Note: When measuring the output or input voltage ripple, do not use the long ground lead on the oscilloscope probe. See Figure 2 for the proper scope probe technique. Short, stiff leads need to be soldered to the (+) and (-) terminals of an output capacitor. The probe's ground ring needs to touch the (-) lead and the probe tip needs to touch the (+) lead.

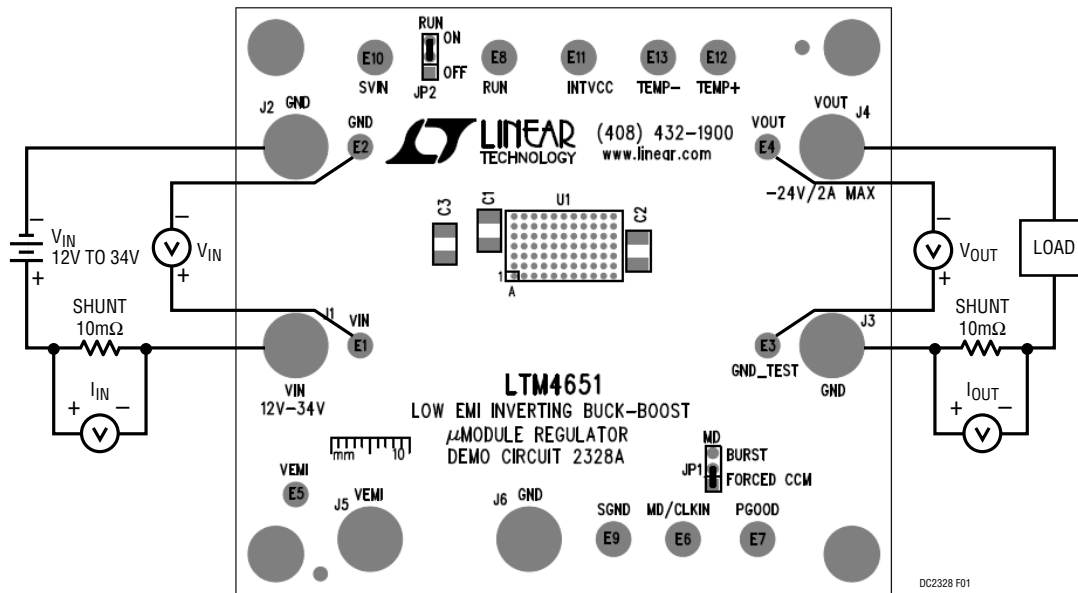

Figure 1. Proper Measurement Equipment Setup

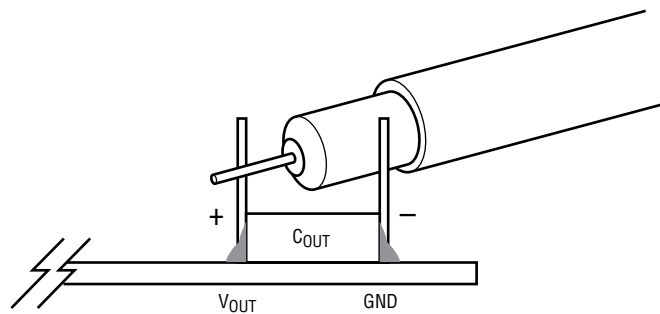

Figure 2. Measuring Output Voltage Ripple

QUICK START PROCEDURE

Optional $-12V_{OUT}$

Besides the default $-24V$ output voltage which shows the full capacity of LTM4651, it is very easy to customize the DC2328A demo board to make other negative output voltages available. As an example, to implement $-12V_{OUT}$ with $5V - 36V V_{IN}$,

1. Change R4 from 14k to 39k. This sets the minimum operation input voltage, 5V for this case.
2. Change R1 and R8 from 240k to 121k. This sets the output voltage, $-12V$ for this case.

Check the input and output capacitor voltage rating. And then it is done.

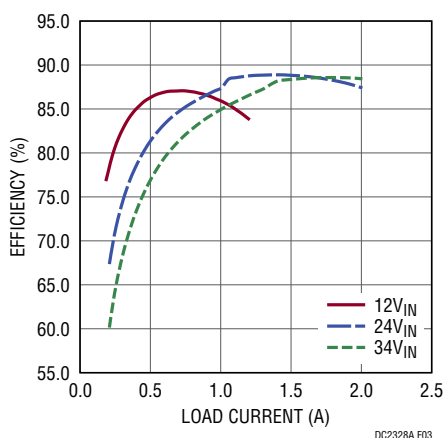

Figure 3. Efficiency vs Load Current ($V_{OUT} = -24V$)

However, to maximize the efficiency of the regulator for different input voltage, the switching frequency can be adjusted by changing R13. For the recommended switching frequency for given input voltage and given output voltage, please refer to the LTM4651 data sheet.

The results for the $-12V_{OUT}$ are listed below.

For $5V_{IN}$, change R13 from 124k to 1.3M Ω . The switching frequency will be 475kHz. For $12V_{IN}$, change R13 from 124k to 237k. The switching frequency will be 825kHz. For $24V_{IN}$, change R13 from 124k to 143k. The switching frequency will be 1.1MHz. For $36V_{IN}$, keep the default R13. The switching frequency will be 1.2MHz.

The optimized efficiency for $-12V_{OUT}$ is as shown in Figure 4.

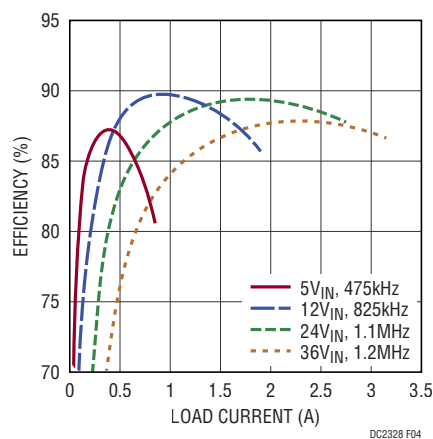

Figure 4. Efficiency vs Load Current ($V_{OUT} = -12V$)

QUICK START PROCEDURE

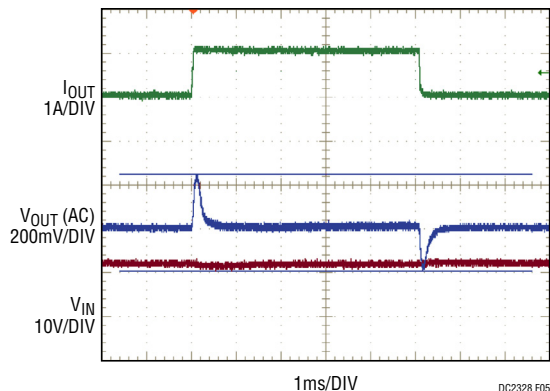

Figure 5. 0A \leftrightarrow 1A Load Transients
($V_{IN} = 12V$, $V_{OUT} = -24V$)

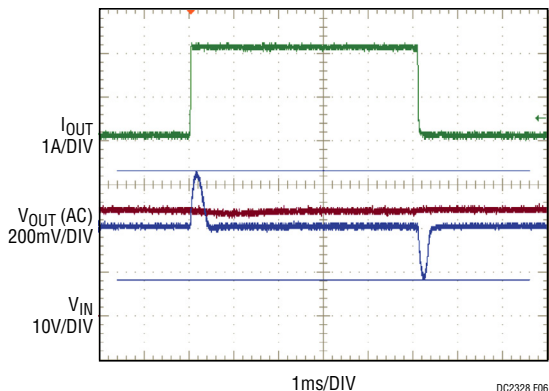

Figure 6. 0A \leftrightarrow 2A Load Transients
($V_{IN} = 24V$, $V_{OUT} = -24V$)

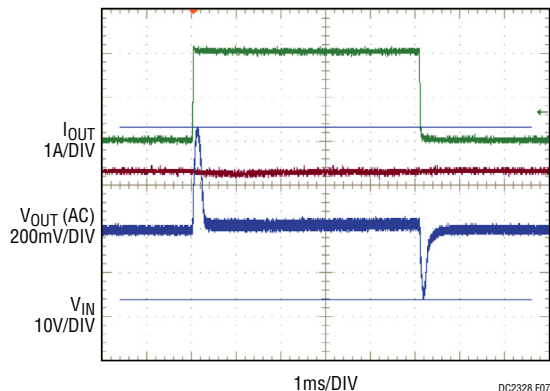

Figure 7. 0A \leftrightarrow 2A Load Transients
($V_{IN} = 34V$, $V_{OUT} = -24V$)

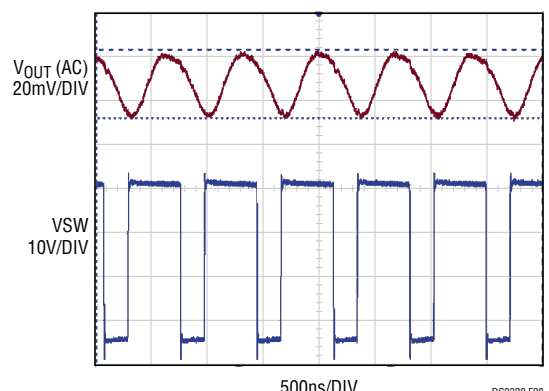

Figure 8. Output Voltage Ripple
($V_{IN} = 12V$, $V_{OUT} = -24V$, 1A Load)

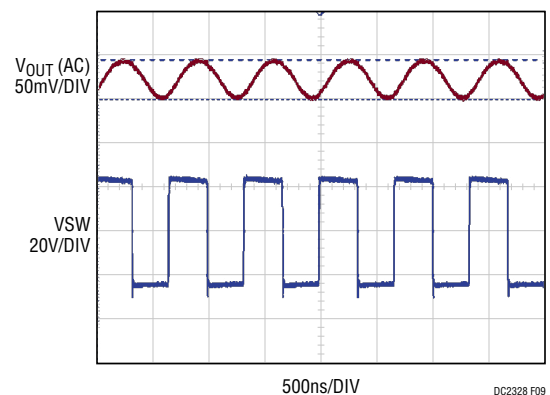

Figure 9. Output Voltage Ripple
($V_{IN} = 24V$, $V_{OUT} = -24V$, 2A Load)

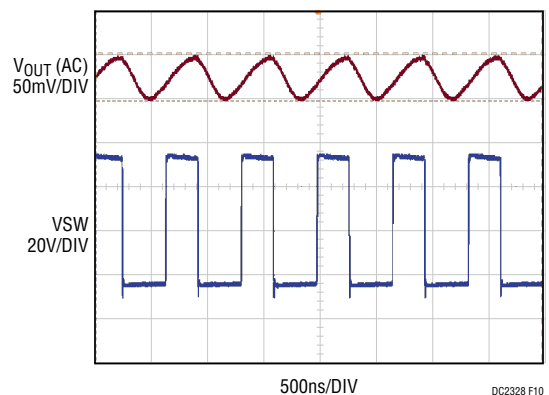

Figure 10. Output Voltage Ripple
($V_{IN} = 34V$, $V_{OUT} = -24V$, 2A Load)

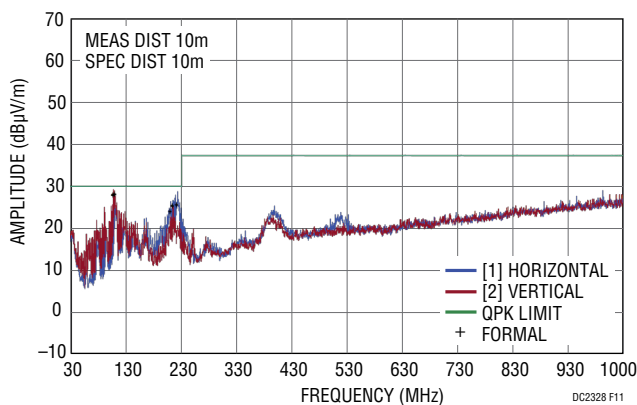

Figure 11. Radiated Emissions Scan of the LTM4651. Producing $-24V_{OUT}$ at 1A, from $12V_{IN}$. DC2328A Hardware. $f_{SW} = 1.2\text{MHz}$. Measured in a 10m Chamber. Peak Detect Method

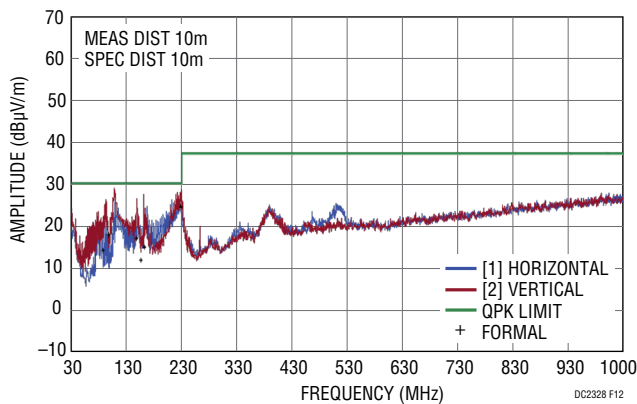

Figure 12. Radiated Emissions Scan of the LTM4651 Producing $-24V_{OUT}$ at 2A, from $25V_{IN}$. DC2328 Hardware. $f_{SW} = 1.2\text{MHz}$. Measured in a 10m Chamber. Peak Detect Method

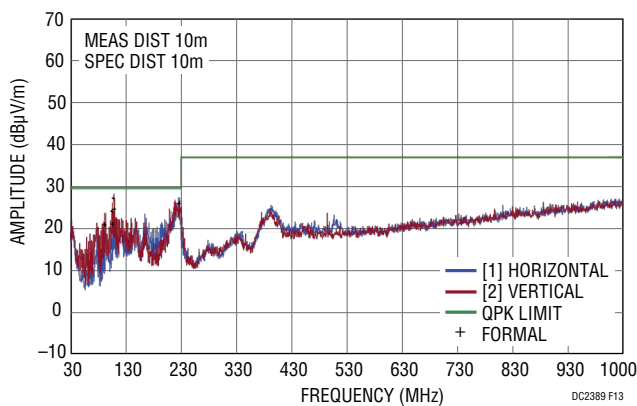

Figure 13. Radiated Emissions Scan of the LTM4651. Producing $-24V$ at 2A, from $34V$. DC2328A Hardware. $f_{SW} = 1.2\text{MHz}$. Measured in a 10m Chamber. Peak Detect Method

DEMO MANUAL DC2328A

PARTS LIST

ITEM	QTY	REFERENCE	PART DESCRIPTION	MANUFACTURER/PART NUMBER
Required Circuit Components				
1	5	C1, C3, C8, C25, C28	CAP, X7R, 4.7 μ F, 80V, 10%, 1210	MURATA, GRM32ER71K475KE14L
2	6	C2, C4, C5, C6, C16, C17	CAP, X7R, 10 μ F, 50V, 10%, 1210	MURATA, GRM32ER71H106KA12L
3	0	C19, C20, C21, C22, C23	CAP, OPT, 1210	OPT
4	1	C7	CAP, ALUM., 100 μ F, 40V, 10x10.5	SUN ELECTRONIC, 40HVP100M
5	1	C9	CAP, X7R, 0.1 μ F, 100V, 10%, 0805	MURATA, GRM21BR72A104KAC4K
6	1	C10	CAP, X7R, 1 μ F, 50V, 10%, 0805	MURATA, GRM21BR71H105KA12L
7	1	C11	CAP, X7R, 4.7nF, 50V, 10%, 0603	MURATA, GRM188R71H472KA01D
8	1	C12	CAP, X7R, 3.3nF, 50V, 10%, 0603	MURATA, GRM188R71H332KA01D
9	1	C13	CAP, X7R, 100nF, 50V, 10%, 0603	MURATA, GRM188R71H104KA93D
10	0	C15	CAP, OPT, 10X10.2	OPT
11	0	C18	CAP, OPT, 0805	OPT
12	0	C24	CAP, OPT, 0603	OPT
13	1	C26	CAP, OS-CON., 82 μ F, 35V, 8x11.9	PANASONIC, 35SVPF82M
14	1	C27	CAP, X5R, 1 μ F, 25V, 10%, 0603	MURATA, GRM188R61E105KA12D
15	0	D1	DIODE, OPT, SOT23	OPT
16	0	D2	DIODE, OPT, SMA	OPT
17	5	E1-E5	TESTPOINT, TURRET, .061"	MILL-MAX, 2308-2-00-80-00-00-07-0
18	8	E6-E13	TESTPOINT, TURRET, .094"	MILL-MAX, 2501-2-00-80-00-00-07-0
19	0	JP1	HEADER, OPT	OPT
20	1	JP2	HEADER, 1X3, 0.079	WURTH ELEKTRONIK, 62000311121
21	6	J1, J2, J3, J4, J5, J6	JACK, BANANA	KEYSTONE, 575-4
22	0	L1	IND, OPT, 1206	OPT
23	0	L2	IND, OPT, IHLP3232CZ-01	OPT
24	2	R1, R8	RES., 240k, 0.1%, 0603	PANASONIC, ERA3AEB244V
25	1	R2	RES., 332 Ω , 1%, 0603	VISHAY, CRCW0603332RFKEA
26	1	R3	RES., 102k, 1%, 0603	VISHAY, CRCW0603102KFKEA
27	1	R4	RES., 14k, 1%, 0603	VISHAY, CRCW060314K0FKEA
28	3	R5, R10, R20	Res., 10 Ω , 1%, 0603	VISHAY, CRCW060310R0FKEA
29	0	R7, R9, R12, R14, R19, R22, R23, R24	RES., OPT, 0603	OPT
30	1	R13	RES., 124k, 1%, 0603	VISHAY, CRCW0603124KFKEA
31	1	R18	RES., 0 Ω , 1%, 0603	VISHAY, CRCW06030000Z0EA
32	1	U1	I.C., LTM4651EY, BGA77-15X9X5.01	LINEAR TECH., LTM4651EY#PBF
33	1	XJP2	SHUNT, 0.079" CENTER	WURTH ELEKTRONIK, 60800213421
34	4	(STAND-OFF)	STAND-OFF, NYLON 0.50"	WURTH ELEKTRONIK, 702935000
35	1		FAB, PRINTED CIRCUIT BOARD	DEMO CIRCUIT, 2328A
36	2		STENCILS TOP AND BOTTOM	STENCIL DC2328A

SCHEMATIC DIAGRAM

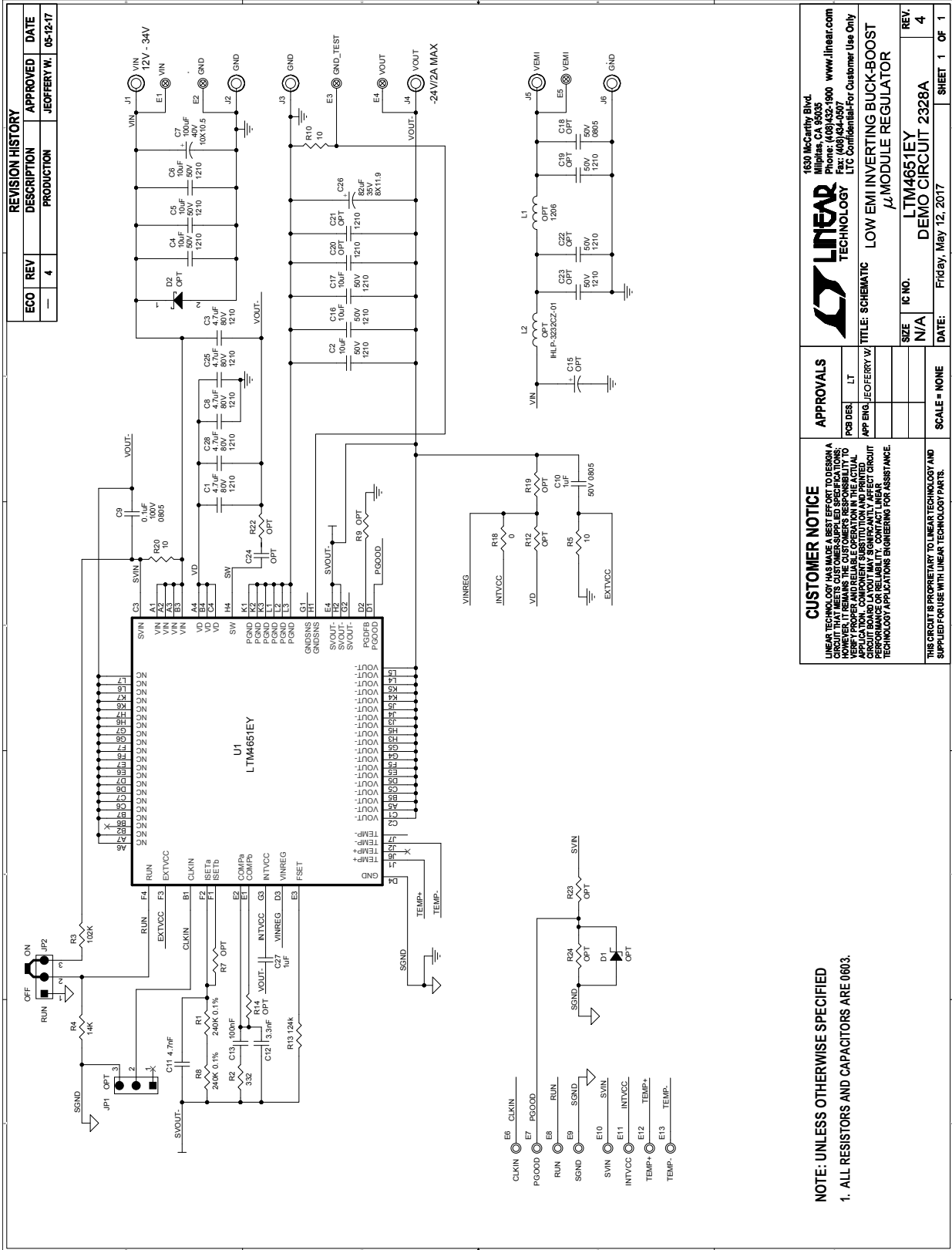

REVISION HISTORY			
ECO	REV	DESCRIPTION	APPROVED DATE
—	4	PRODUCTION	JEC/FERY W/ 05-12-17

CUSTOMER NOTICE
 LINEAR TECHNOLOGY HAS MADE A BEST EFFORT TO DESIGN A VERIFIABLE AND RELIABLE OPERATION IN THE ACTUAL CIRCUIT BOARD LAYOUT. ANY SIGNIFICANTLY AFFECT CIRCUIT PERFORMANCE OR RELIABILITY. CONTACT LINEAR TECHNOLOGY APPLICATIONS ENGINEERING FOR ASSISTANCE.

APPROVALS
 PCB DES: LT
 APP ENG: JEC/FERY W/

1630 McCarthy Blvd.
 Milpitas, CA 95035
 Phone: (408)432-1900 www.linear.com
 Fax: (408)434-1907
 LTC is Compliant for Customer Use Only

TITLE: SCHEMATIC LOW EMI INVERTING BUCK-BOOST μMODULE REGULATOR

SIZE	IC NO.	REV.
N/A	LTM4651EY	4
SCALE = NONE	DATE: Friday, May 12, 2017	SHEET 1 OF 1

THIS CIRCUIT IS PROPRIETARY TO LINEAR TECHNOLOGY AND SUPPLIED FOR USE WITH LINEAR TECHNOLOGY PARTS.

NOTE: UNLESS OTHERWISE SPECIFIED
 1. ALL RESISTORS AND CAPACITORS ARE 0603.

DEMO MANUAL DC2328A

DEMONSTRATION BOARD IMPORTANT NOTICE

Linear Technology Corporation (LTC) provides the enclosed product(s) under the following **AS IS** conditions:

This demonstration board (DEMO BOARD) kit being sold or provided by Linear Technology is intended for use for **ENGINEERING DEVELOPMENT OR EVALUATION PURPOSES ONLY** and is not provided by LTC for commercial use. As such, the DEMO BOARD herein may not be complete in terms of required design-, marketing-, and/or manufacturing-related protective considerations, including but not limited to product safety measures typically found in finished commercial goods. As a prototype, this product does not fall within the scope of the European Union directive on electromagnetic compatibility and therefore may or may not meet the technical requirements of the directive, or other regulations.

If this evaluation kit does not meet the specifications recited in the DEMO BOARD manual the kit may be returned within 30 days from the date of delivery for a full refund. **THE FOREGOING WARRANTY IS THE EXCLUSIVE WARRANTY MADE BY THE SELLER TO BUYER AND IS IN LIEU OF ALL OTHER WARRANTIES, EXPRESSED, IMPLIED, OR STATUTORY, INCLUDING ANY WARRANTY OF MERCHANTABILITY OR FITNESS FOR ANY PARTICULAR PURPOSE. EXCEPT TO THE EXTENT OF THIS INDEMNITY, NEITHER PARTY SHALL BE LIABLE TO THE OTHER FOR ANY INDIRECT, SPECIAL, INCIDENTAL, OR CONSEQUENTIAL DAMAGES.**

The user assumes all responsibility and liability for proper and safe handling of the goods. Further, the user releases LTC from all claims arising from the handling or use of the goods. Due to the open construction of the product, it is the user's responsibility to take any and all appropriate precautions with regard to electrostatic discharge. Also be aware that the products herein may not be regulatory compliant or agency certified (FCC, UL, CE, etc.).

No License is granted under any patent right or other intellectual property whatsoever. **LTC assumes no liability for applications assistance, customer product design, software performance, or infringement of patents or any other intellectual property rights of any kind.**

LTC currently services a variety of customers for products around the world, and therefore this transaction **is not exclusive**.

Please read the DEMO BOARD manual prior to handling the product. Persons handling this product must have electronics training and observe good laboratory practice standards. **Common sense is encouraged.**

This notice contains important safety information about temperatures and voltages. For further safety concerns, please contact a LTC application engineer.

Mailing Address:

Linear Technology
1630 McCarthy Blvd.
Milpitas, CA 95035

Copyright © 2004, Linear Technology Corporation