

Schottky Rectifier, 2 x 20 A

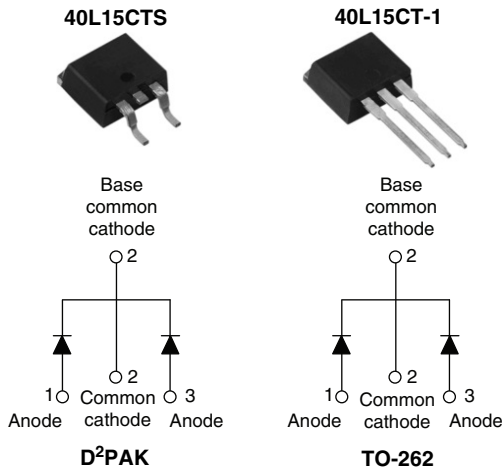

FEATURES

- 125 °C T_J operation ($V_R < 5 V$)
- Center tap module
- Optimized for OR-ing applications
- Ultra low forward voltage drop
- High frequency operation
- High purity, high temperature epoxy encapsulation for enhanced mechanical strength and moisture resistance
- Guard ring for enhanced ruggedness and long term reliability
- Designed and qualified for Q101 level

DESCRIPTION

The center tap Schottky rectifier module has been optimized for ultra low forward voltage drop specifically for the OR-ing of parallel power supplies. The proprietary barrier technology allows for reliable operation up to 125 °C junction temperature. Typical applications are in parallel switching power supplies, converters, reverse battery protection, and redundant power subsystems.

PRODUCT SUMMARY

$I_{F(AV)}$	2 x 20 A
V_R	15 V
I_{RM}	600 mA at 100 °C

MAJOR RATINGS AND CHARACTERISTICS

SYMBOL	CHARACTERISTICS	VALUES	UNITS
$I_{F(AV)}$	Rectangular waveform	40	A
V_{RRM}		15	V
I_{FSM}	$t_p = 5 \mu s$ sine	700	A
V_F	19 Apk, $T_J = 125 \text{ °C}$ (per leg, typical)	0.25	V
T_J		- 55 to 125	°C

VOLTAGE RATINGS

PARAMETER	SYMBOL	TEST CONDITIONS	40L15CTS 40L15CT-1	UNITS
Maximum DC reverse voltage	V_R	$T_J = 100 \text{ °C}$	15	V
Maximum working peak reverse voltage	V_{RWM}			

ABSOLUTE MAXIMUM RATINGS

PARAMETER	SYMBOL	TEST CONDITIONS	VALUES	UNITS
Maximum average forward current See fig. 5	$I_{F(AV)}$	50 % duty cycle at $T_C = 85 \text{ °C}$, rectangular waveform	20	A
			40	
Maximum peak one cycle non-repetitive surge current per leg See fig. 7	I_{FSM}	5 μs sine or 3 μs rect. pulse	700	A
		10 ms sine or 6 ms rect. pulse	330	
Non-repetitive avalanche energy per leg	E_{AS}	$T_J = 25 \text{ °C}$, $I_{AS} = 2 A$, $L = 6 mH$	10	mJ
Repetitive avalanche current per leg	I_{AR}	Current decaying linearly to zero in 1 μs Frequency limited by T_J maximum $V_A = 1.5 \times V_R$ typical	2	A

ELECTRICAL SPECIFICATIONS						
PARAMETER	SYMBOL	TEST CONDITIONS	TYP.	MAX.	UNITS	
Maximum forward voltage drop per leg See fig. 1	$V_{FM}^{(1)}$	19 A	$T_J = 25\text{ }^\circ\text{C}$	-	0.41	V
		40 A		-	0.52	
		19 A	$T_J = 125\text{ }^\circ\text{C}$	0.25	0.33	
		40 A		0.37	0.50	
Reverse leakage current per leg See fig. 2	$I_{RM}^{(1)}$	$T_J = 25\text{ }^\circ\text{C}$	$V_R = \text{Rated } V_R$	-	10	mA
		$T_J = 100\text{ }^\circ\text{C}$		-	600	
Threshold voltage	$V_{F(TO)}$	$T_J = T_J \text{ maximum}$	0.182		V	
Forward slope resistance	r_t		7.6		m Ω	
Maximum junction capacitance per leg	C_T	$V_R = 5 V_{DC}$ (test signal range 100 kHz to 1 MHz) 25 $^\circ\text{C}$	-	2000	pF	
Typical series inductance per leg	L_S	Measured lead to lead 5 mm from package body	8	-	nH	
Maximum voltage rate of change	dV/dt	Rated V_R	10 000		V/ μs	

Note

(1) Pulse width < 300 μs , duty cycle < 2 %

THERMAL - MECHANICAL SPECIFICATIONS				
PARAMETER	SYMBOL	TEST CONDITIONS	VALUES	UNITS
Maximum junction temperature range	T_J		- 55 to 125	$^\circ\text{C}$
Maximum storage temperature range	T_{Stg}		- 55 to 150	
Maximum thermal resistance, junction to case per leg	R_{thJC}	DC operation See fig. 4	1.5	$^\circ\text{C/W}$
Typical thermal resistance, case to heatsink	R_{thCS}	Mounting surface, smooth and greased (Only for TO-262)	0.50	
Maximum thermal resistance, junction to ambient	R_{thJA}	DC operation	40	
Approximate weight			2	g
			0.07	oz.
Mounting torque	minimum	Non-lubricated threads	6 (5)	kgf · cm (lbf · in)
	maximum		12 (10)	
Marking device		Case style D ² PAK	40L15CTS	
		Case style TO-262	40L15CT-1	

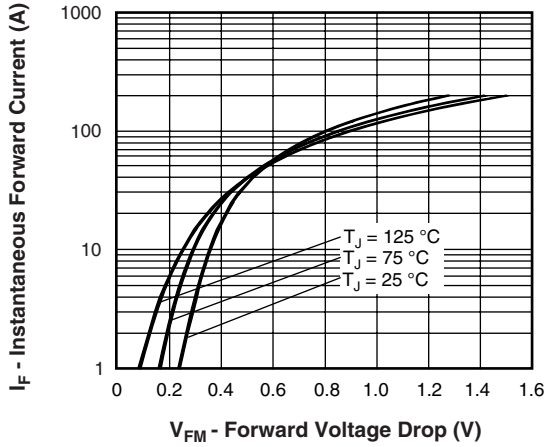

Fig. 1 - Maximum Forward Voltage Drop Characteristics

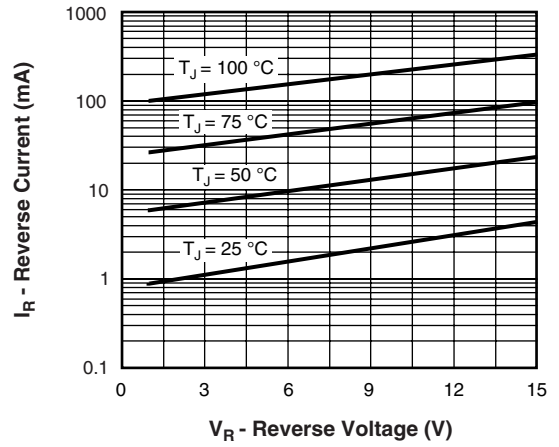

Fig. 2 - Typical Values of Reverse Current vs. Reverse Voltage

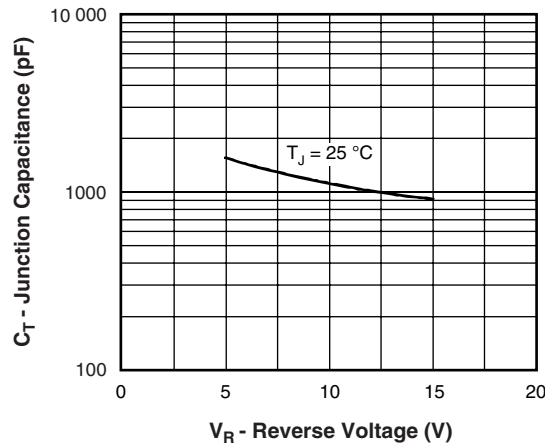

Fig. 3 - Typical Junction Capacitance vs. Reverse Voltage

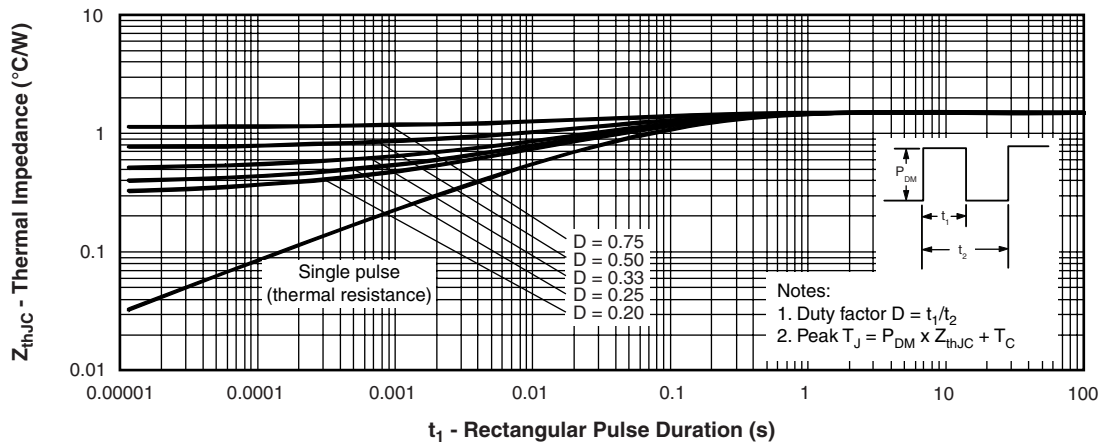

Fig. 4 - Maximum Thermal Impedance Z_{thJC} Characteristics

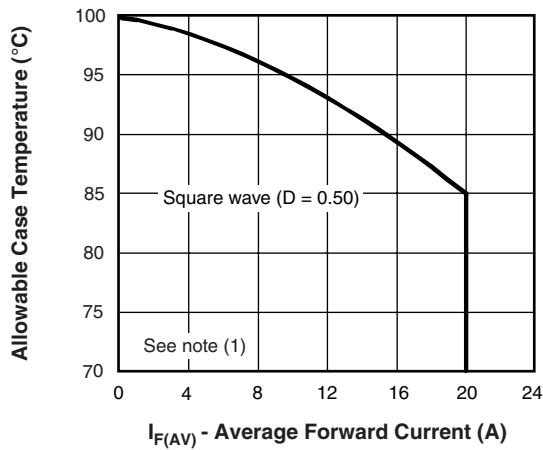

Fig. 5 - Maximum Allowable Case Temperature vs. Average Forward Current

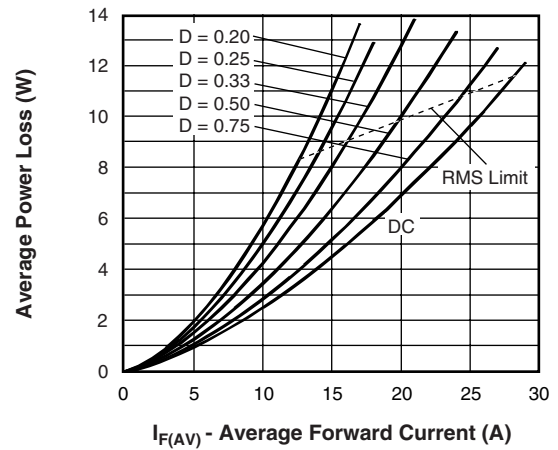

Fig. 6 - Forward Power Loss Characteristics

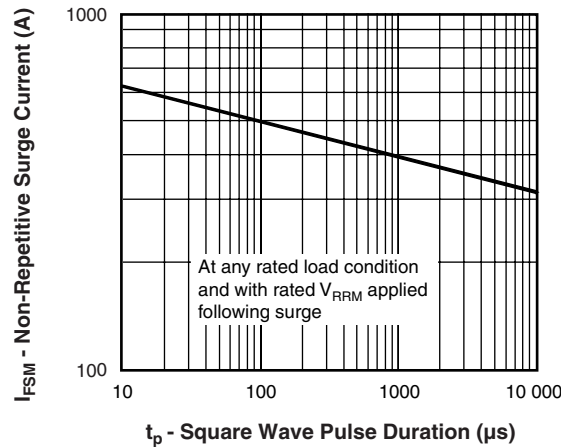

Fig. 7 - Maximum Non-Repetitive Surge Current



Fig. 8 - Unclamped Inductive Test Circuit

Note

- (1) Formula used: $T_C = T_J - (P_d + P_{d_{REV}}) \times R_{thJC}$;
- P_d = Forward power loss = $I_{F(AV)} \times V_{FM}$ at $(I_{F(AV)}/D)$ (see fig. 6);
- $P_{d_{REV}}$ = Inverse power loss = $V_{R1} \times I_R (1 - D)$; I_R at $V_{R1} = 80\%$ rated V_R



ORDERING INFORMATION TABLE

Device code	40	L	15	C	T	S	TRL	-
	①	②	③	④	⑤	⑥	⑦	⑧

- 1** - Current rating (40 A)
- 2** - L = Schottky "L" series
- 3** - Voltage rating (15 V)
- 4** - C = Common cathode
- 5** - T = TO-220
- 6** -
 - S = D²PAK
 - -1 = TO-262
- 7** -
 - None = Tube (50 pieces)
 - TRL = Tape and reel (left oriented - for D²PAK only)
 - TRR = Tape and reel (right oriented - for D²PAK only)
- 8** -
 - None = Standard production
 - PbF = Lead (Pb)-free

LINKS TO RELATED DOCUMENTS	
Dimensions	http://www.vishay.com/doc?95014
Part marking information	http://www.vishay.com/doc?95008
Packaging information	http://www.vishay.com/doc?95032



Disclaimer

All product specifications and data are subject to change without notice.

Vishay Intertechnology, Inc., its affiliates, agents, and employees, and all persons acting on its or their behalf (collectively, "Vishay"), disclaim any and all liability for any errors, inaccuracies or incompleteness contained herein or in any other disclosure relating to any product.

Vishay disclaims any and all liability arising out of the use or application of any product described herein or of any information provided herein to the maximum extent permitted by law. The product specifications do not expand or otherwise modify Vishay's terms and conditions of purchase, including but not limited to the warranty expressed therein, which apply to these products.

No license, express or implied, by estoppel or otherwise, to any intellectual property rights is granted by this document or by any conduct of Vishay.

The products shown herein are not designed for use in medical, life-saving, or life-sustaining applications unless otherwise expressly indicated. Customers using or selling Vishay products not expressly indicated for use in such applications do so entirely at their own risk and agree to fully indemnify Vishay for any damages arising or resulting from such use or sale. Please contact authorized Vishay personnel to obtain written terms and conditions regarding products designed for such applications.

Product names and markings noted herein may be trademarks of their respective owners.