

Firmware Version V1.02

TMC4210+TMC2660 EVALUATION BOARD MANUAL

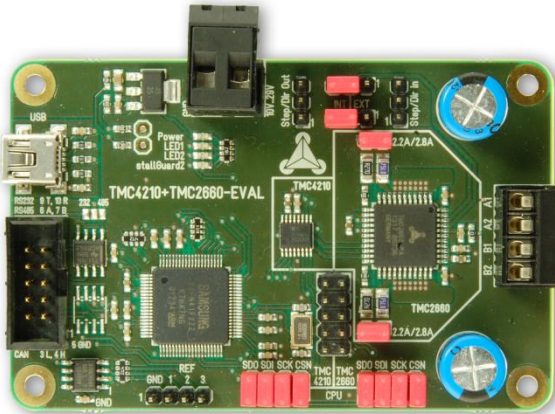

TMC4210+TMC2660-EVAL

Evaluation Board for
 TMC4210 Motion Controller and
 TMC2660 Stepper Motor Driver for
 Two Phase Stepper Motor
 Up to 2.8A RMS/ +10V... 29V DC
 USB, RS485, CAN, RS232 (TTL level),
 and SPI interfaces
 3x Ref. Switch Input

UNIQUE FEATURES

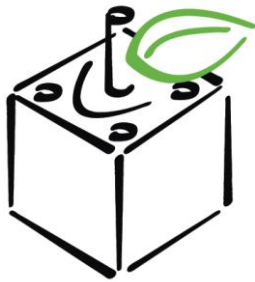

coolStep™

stallGuard2™

TABLE OF CONTENTS

1	Features.....	3
2	Order Codes.....	4
3	Hardware.....	5
3.1	Mechanical and Electrical Interfacing.....	5
3.1.1	Size of the TMC4210+TMC2660-EVAL and Mounting Holes.....	5
3.1.2	Connectors.....	6
3.1.3	Jumper.....	10
3.1.4	LEDs.....	13
3.1.5	Chopper Test Points.....	13
4	Operational Ratings.....	15
5	Functional Description.....	16
6	Getting Started – How to Connect the Board.....	17
6.1	Motor Current Setting.....	18
7	Evaluation Software.....	20
7.1	The Main Window.....	20
7.1.1	Ramp Mode Selection.....	20
7.1.2	Examples.....	21
7.2	Graphic Display.....	22
7.3	TMC4210 Register Dialog.....	23
7.3.1	Motor Tab.....	23
7.3.2	TMC4210 Global Parameter Tab.....	24
7.4	TMC2660 Registers.....	25
7.4.1	DRVCTRL Tab.....	25
7.4.2	CHOPCONF Register Tab.....	26
7.4.3	SMARTEN Register Tab.....	26
7.4.4	SGCSCONF Register Tab.....	27
7.4.5	DRVCONF Register Tab.....	27
7.4.6	DRVSTATUS Register Tab.....	28
7.4.7	Graph Tab.....	28
7.5	Logging Dialog.....	29
8	Life Support Policy.....	30
9	Revision History.....	31
10	References.....	31

1 Features

The TMC4210+TMC2660 evaluation board is designed for evaluating all features of the TMC4210 motion controller in combination with the Step/Dir driver TMC2660 with integrated MOSFETs. The Samsung S3FN41F microcontroller is used to control the TMC4210 and the communication. A software running under Windows enables access to all registers and functions of the TMC4210 from a PC.

MAIN CHARACTERISTICS

Application

- Evaluation of all features of the TMC4210 controlling the TMC2660 motor driver chip.

TMC4210 Motion Controller

- 1-Axis stepper motor controller
- Serial 4-wire interface to μ C with easy-to-use protocol
- Step/Direction interface to driver
- Clock frequency: up to 32 MHz (can use CPU clock)
- Internal position counters 24 bit wide
- Microstep frequency up to 1 MHz
- Read-out option for all motion parameters
- Ramp generator for autonomous positioning / speed control
- On-the-fly change of target motion parameters

TMC2660 Motor Driver

- up to 256 times microstepping per full step via Step/Dir
- integrated power transistors for up to 2.8A RMS / 4A peak
- Protection & Diagnostics overcurrent, short to GND, overtemperature & undervoltage
- stallGuard2™ high precision sensorless motor load detection
- coolStep™ load dependent current control for energy savings up to 75%
- microPlyer™ microstep interpolation for increased smoothness with coarse step inputs.
- spreadCycle™ high-precision chopper for best current sine wave form and zero crossing

Electrical Data

- Supply voltage: +10... +29V DC operating voltage
- Maximum motor current: 2.8A RMS (4A peak)

Interfaces

- USB (type B)
- RS232 (TTL level)
- RS485
- CAN
- SPI interface for external microcontroller
- Home switch and stop switches

Safety Features

- Overcurrent detection
- Short to GND detection
- Undervoltage protection
- Integrated diagnostics

Software

- PC demonstration software allowing access to all registers

TRINAMICs UNIQUE FEATURES

stallGuard2™ stallGuard2 is a high-precision sensorless load measurement using the back EMF on the coils. It can be used for stall detection as well as other uses at loads below those which stall the motor. The stallGuard2 measurement value changes linearly over a wide range of load, velocity, and current settings. At maximum motor load, the value goes to zero or near to zero. This is the most energy-efficient point of operation for the motor.

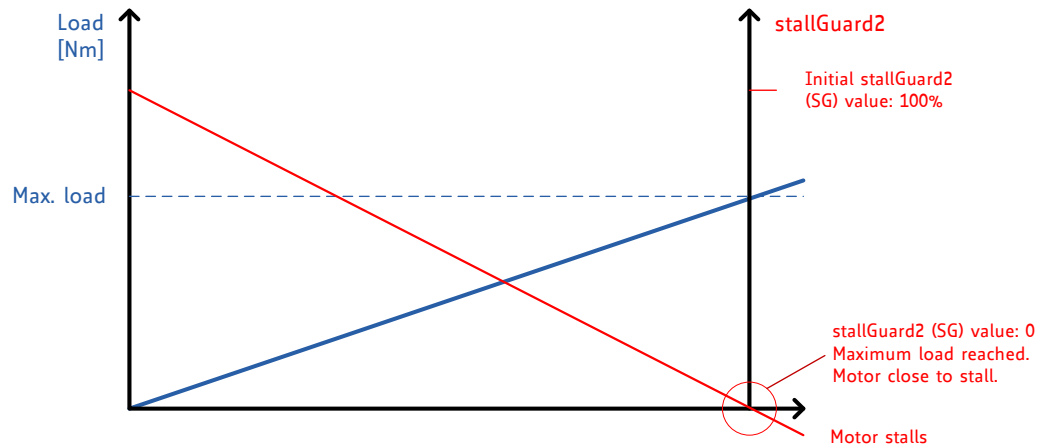

Figure 1.1 stallGuard2 load measurement SG as a function of load

coolStep™ coolStep is a load-adaptive automatic current scaling based on the load measurement via stallGuard2 adapting the required current to the load. Energy consumption can be reduced by as much as 75%. coolStep allows substantial energy savings, especially for motors which see varying loads or operate at a high duty cycle. Because a stepper motor application needs to work with a torque reserve of 30% to 50%, even a constant-load application allows significant energy savings because coolStep automatically enables torque reserve when required. Reducing power consumption keeps the system cooler, increases motor life, and allows reducing cost.

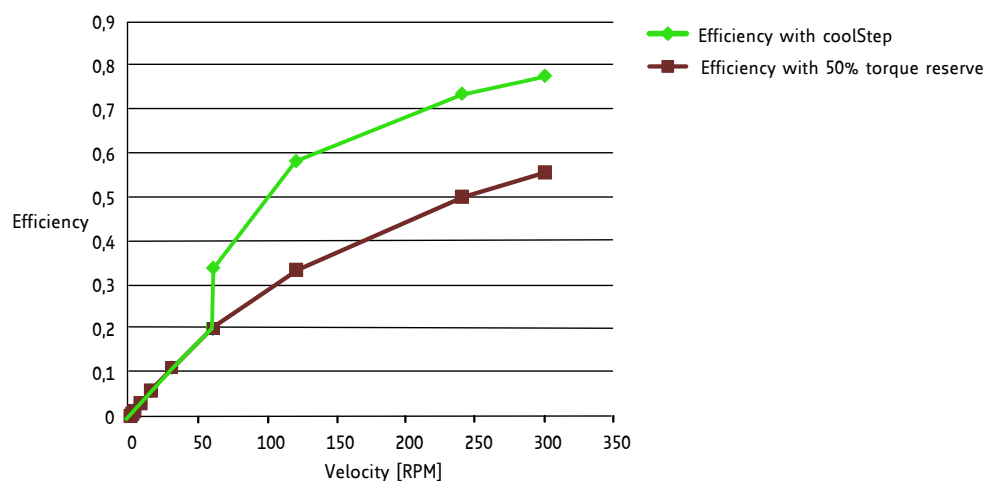

Figure 1.2 Energy efficiency example with coolStep

2 Order Codes

Order code	Description	Size of unit [mm ³]
TMC4210+TMC2660-EVAL	Evaluation board for TMC4210 motion controller and TMC2660 stepper motor driver.	85 x 55 x 16.2

Table 2.1 Order codes

3 Hardware

Attention

See also the schematics of the evaluation board (supplied as PDF files on www.trinamic.com) for a better understanding of this description.

3.1 Mechanical and Electrical Interfacing

3.1.1 Size of the TMC4210+TMC2660-EVAL and Mounting Holes

The board dimensions are 85mm x 55mm without mating connectors. Maximum component height (height above PCB level) without mating connectors is 13mm. There are four mounting holes suitable for M3 screws.

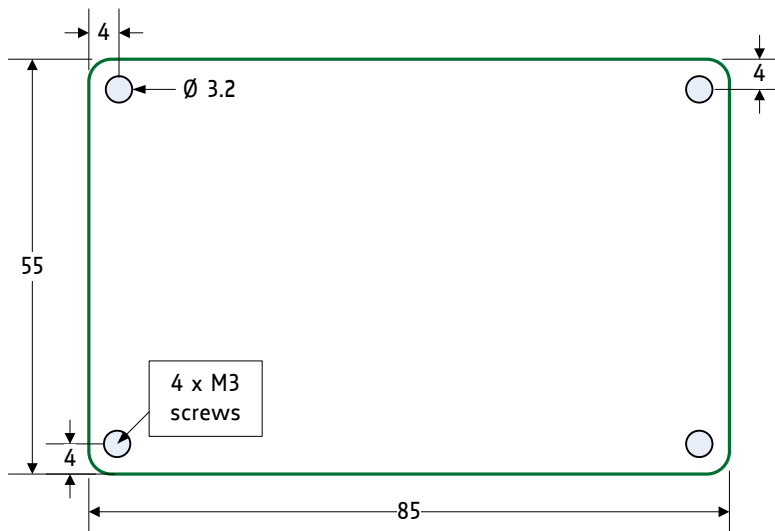

Figure 3.1 TMC4210+TMC2660-EVAL dimensions

3.1.2 Connectors

The evaluation board has eight connectors altogether. Usually, the controller driver chain consisting of the TMC4210 and the TMC2660 is an optimum choice for a wide range of applications. However, the chips can be tested independently from each other. Just connect the TMC4210 with an external driver board or test the TMC2660 with an external motion controller board. Further, it is possible to use Step/Dir signals generated by an external microcontroller with additional software or by an external Step/Dir generator while the onboard microcontroller is doing configurations. All options for evaluation can be chosen by jumper. Please refer to chapter 3.1.3 for further information.

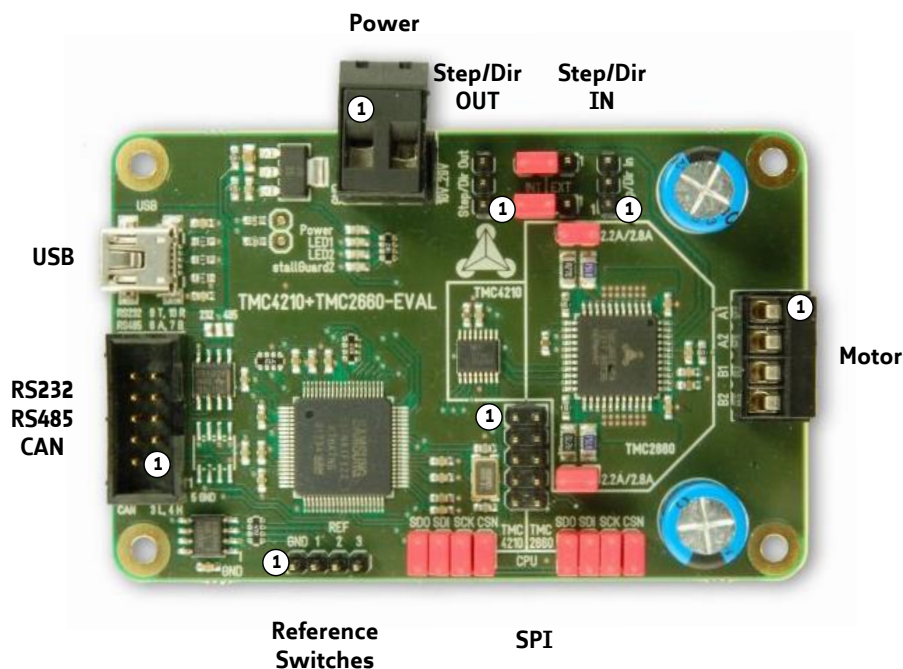

Figure 3.2 Connectors of TMC4210+TMC2660-EVAL

CONNECTORS OF TMC4210+TMC2660-EVAL

Label (KEY)	Connector type	Mating connector type
Power (K102)	RIA 320-02, 2 pol., 5mm pitch, shrouded header	RIA 349-2, screw type terminal block, pluggable, centerline 5 mm / 0.197 inches, wire entry parallel to plug direction
Motor (K302)	RIA 183-04, 4 pol. 3.5mm pitch, header	RIA 169-04, screw type terminal block, pluggable, centerline 3.5 mm / 0.138 inches, wire entry parallel to plug direction
USB (K101)	USB, type B, 5 pol., female	USB, type B, 5 pol., male
Ref. Switches (K201)	Multi-pin-connector, 4 pol., 2.54mm pitch	Female connector with 2.54mm pitch
RS232, RS485, CAN (K103)	Low profile box header without locking bar, 10pol., DIN 41651, 2.54 pitch, 0.64mm pin diameter	Low profile IDC socket connector, 10pol., DIN41651, 2.54 pitch
Step/Dir OUT (K202)	Multi-pin-connector, 3 pol., 2.54mm pitch	Female connector with 2.54mm pitch
Step/Dir IN (K203)	Multi-pin-connector, 3 pol., 2.54mm pitch	Female connector with 2.54mm pitch
SPI (K104)	Multi-pin-connector, 10 pol., 2.54mm pitch	Female connector with 2.54mm pitch

Table 3.1 Connectors

3.1.2.1 Power Connector (K102)

Pin	Label	Description
1	GND	Power supply and signal ground
2	VS	Operational voltage is +10... +29V DC.

Table 3.2 Power connector

3.1.2.1.1 Digital Power Supply

The digital operating voltages (3.3V for the microcontroller and 5V for all other parts) are generated onboard.

3.1.2.2 Motor Connector (K302)

Pin	Label	Direction	Description
1	OA1	Output	Pin 1 of motor coil A
2	OA2	Output	Pin 2 of motor coil A
3	OB1	Output	Pin 1 of motor coil B
4	OB2	Output	Pin 2 of motor coil B

Table 3.3 Motor connector

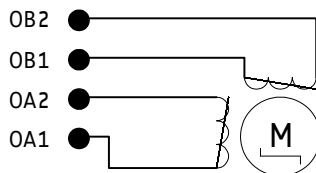

Figure 3.3 How to connect a stepper motor

3.1.2.3 Reference Switch Connector (K201)

The TMC4210 offers three reference switch inputs for the axis. Normally, REF1 is the left switch input, REF2 is the right switch input, and REF3 can be used as home switch.

Pin	Label	Direction	Description
1	GND	Power (GND)	System and module ground
2	REF1	Input	Reference switch input 1 of TMC4210
3	REF2	Input	Reference switch input 2 of TMC4210
4	REF3	Input	Reference switch input 3 of TMC4210 / home switch input

Table 3.4 Reference switch connector

3.1.2.4 USB Connector (K101)

A USB interface is available via a mini-USB type B connector. This module supports USB 2.0 Full-Speed (12Mbit/s) connections.

Pin	Label	Direction	Description
1	VBUS	Power (+5V input)	+5V supply from host
2	D-	bi-directional	USB Data -
3	D+	bi-directional	USB Data +
4	ID		Not connected
5	GND	Power (GND)	Signal and system ground

Table 3.5 USB connector

3.1.2.5 RS232, RS485, and CAN Interface Connector (K103)

Communication between PC and evaluation board can take place using three different interfaces: RS485, RS232, and CAN. Please note, that RS232_RXD and RS232_TXD have TTL level 3.3V.

Pin	Label	Direction	Description
1			
2			
3	CAN_L	bi-directional	Differential CAN bus signal (inverting) - retro-fit option
4	CAN_H	bi-directional	Differential CAN bus signal (non-inverting) - retro-fit option
5	GND	Power (GND)	Signal and system ground
6	RS485+	bi-directional	Differential RS485 bus signal (non-inverting)
7	RS485-	bi-directional	Differential RS485 bus signal (inverting)
8			
9	RS232_TXD	Output	RS232 transmit data (TTL level 3.3V)
10	RS232_RXD	Input	RS232 receive data (TTL level 3.3V)

3.1 High-level interface connector

3.1.2.5.1 RS232 and RS485

For using the RS485 interface or the RS232 interface, it is necessary to solder a bridge on the evaluation board first. The TMC4210+TMC2660-EVAL is equipped with a transceiver that fits for both interfaces.



Solder bridge for RS232



Solder bridge for RS485

Figure 3.4 Solder bridges for RS232 and RS485

3.1.2.5.2 CAN

For using the CAN interface it is necessary to retrofit a CAN transceiver.

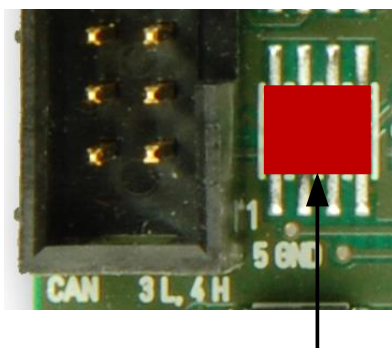

Solder CAN transceiver here

Figure 3.5 Place for CAN transceiver

3.1.2.6 Serial Peripheral Interface Connector (K104)

For connecting an external CPU to the TMC4210, use the pins 3, 5, 7, and 9. For testing the TMC2660 motor driver chip with external CPU, connect the pins 4, 6, 8, and 10.

Before connecting the external CPU jumpers have to be removed. Please refer to chapter 3.1.3.4.

Pin	Label	Direction	Description
1	GND	Power (GND)	System and module ground
2	GND	Power (GND)	System and module ground
3	SDO_4210	Output	Serial data output of TMC4210 to external microcontroller
4	SDO_2660	Output	Serial data output of TMC2660 to external microcontroller
5	SDI_4210	Input	Serial data input of external microcontroller to TMC4210
6	SDI_2660	Input	Serial data input of external microcontroller to TMC2660
7	SCK_4210	Input	Serial data clock input from external microcontroller to TMC4210
8	SCK_2660	Input	Serial data clock input from external microcontroller to TMC2660
9	CSN_4210	Input	CSN input of TM4210
10	CSN_2660	Input	CSN input of TMC2660

3.2 SPI connector

3.1.2.7 Step/Direction Connector IN (K203)

Plugging this connector an external motion controller can be used with the on-board driver electronics. Another possibility is to generate Step/Dir signals using the microcontroller and additional software. Before connecting an external motion controller instead of the on-board TMC4210 motion controller a jumper has to be set as explained in chapter 3.1.3.2.

Pin	Label	Direction	Description
1	GND	Power (GND)	Signal and System ground
2	Step In	Input	Driver step input signal (+5V compatible)
3	Dir In	Input	Driver direction input signal (+5V compatible)

Table 3.6 Step/Dir input connector

3.1.2.8 Step/Direction Connector OUT (K202)

The TMC4210 motion controller on the evaluation board can be tested with an external motor driver chip. Therefore, the Step/Dir outputs of the TMC4210 (TTL level) are led through to the Step/Dir OUT connector. Before connecting an external stepper motor driver instead of the on-board TMC2660 a jumper has to be set as explained in chapter 3.1.3.3.

Pin	Label	Direction	Description
1	GND	Power (GND)	Signal and System ground
2	Step Out	out	Driver step output signal (+5V compatible)
3	Dir Out	out	Driver direction output signal (+5V compatible)

Table 3.7 Step/Dir OUT connector

3.1.3 Jumper

The evaluation board offers possibilities for settings by jumper. Per default jumper setting, TMC4210 is connected to the onboard microcontroller and the onboard stepper motor driver TMC2660. This controller driver chain is proven and suits to a wide range of motors and applications. However, if it is desired to evaluate, e.g., the TMC4210 with your own customer specific driver board or with an external microcontroller, connections to onboard components can be cut and signals can be led through to the specific connectors on the board. This way, the TMC4210 and TMC2660 can be tested as part of the controller driver chain on the board or separately with further external parts.

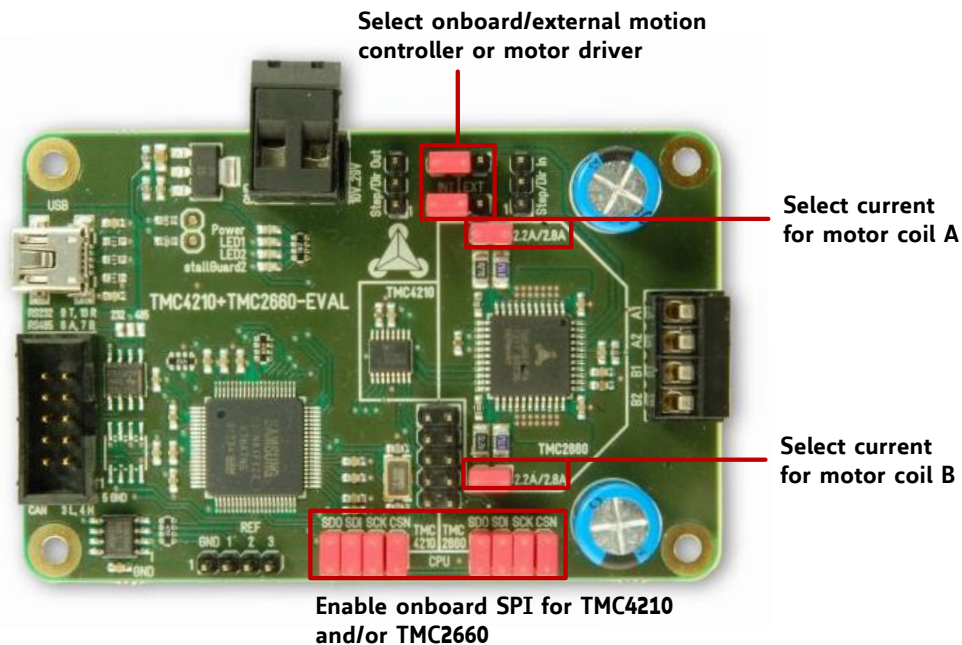

Figure 3.6 Overview jumper settings

3.1.3.1 Motor Current Selection

The TMC4210+TMC2660-EVAL offers the possibility to choose the desired motor current by jumper. In case the jumpers are plugged, a motor current up to 2.8A RMS is chosen. For a motor current up to 2.2A let the jumpers unplugged.

MOTOR CURRENT

Jumper	Label	Description
Select motor current	2.2A/2.8A	Jumper plugged motor current up to 2.8A RMS Jumper unplugged motor current up to 2.2A RMS

Table 3.8 Motor current selection by jumper

Please be aware, that the evaluation board software only can display the correct current, when checking the "Jumper" selection correctly. Be sure, not to work with current settings, exceeding the TMC2660 ratings.

3.1.3.2 Motion Controller Selection

Per default jumper setting, the TMC2660 motor driver is connected to the TMC4210 as shown in Figure 3.6. In case an external motion controller is to be tested together with the TMC2660 motor driver plug a jumper on pin 1 and pin 2 of each multiple pin connector. Now, use the *Step/Dir In* connector to connect the TMC2660 step and direction input pins with the Step/Dir output signals of your external motion controller.

MOTION CONTROLLER

Jumper	Label	Description	
Select motion controller	2-3 TMC4210 1-2 external	Set jumpers to select motion controller TMC4210 (on the board) or external one.	
		Jumper pins	Result
		1, 2	External motion controller selected.
	2, 3	TMC4210 selected.	

Table 3.9 Motion controller selection by jumpers



Figure 3.7 Jumper setting for TMC4210 selection.

3.1.3.3 Stepper Motor Driver Selection

Per default jumper setting, the TMC2660 motor driver is connected to the TMC4210 as shown in Figure 3.6. In case an external stepper motor driver board should be tested, plug a jumper on pin 1 and pin 2 of each multi pin connector. Now, use the *Step/Dir Out* connector to go on with the external driver board. The driver step and driver direction signals of the TMC4210 are led through to the connector.

MOTION CONTROLLER

Jumper	Label	Description	
Select motor driver	2-3 TMC2660 1-2 external	Set jumpers to select stepper motor driver TMC2660 (on the board) or external one.	
		Jumper pins	Result
		1, 2	External driver selected.
	2, 3	TMC2660 selected.	

In case it is desired to compare the TMC2660 with an external stepper driver chip plug the jumper just as for TMC2660 selection (pin 2 and 3). Remember, that the TMC4210 is able to control only one motor axis. Therefore, both driver chips react to the same Step/Dir signals and execute the same commands coevally.

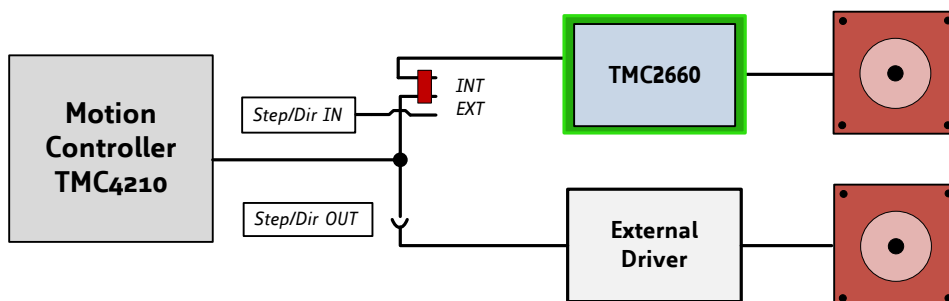

Figure 3.8 Schematic: how to compare motor driver chips

3.1.3.4 Microcontroller Selection

Per default jumper setting, the Samsung S3FN41F microcontroller is connected to the TMC4210 motion controller and to the TMC2660 stepper driver. Note, that the TMC2660 Step/Dir driver uses the SPI interface for configuration purposes, only. For normal operation of the board, all eight jumpers have to be plugged (see Figure 3.9).

In case it is desired to evaluate a customer specific microcontroller in combination with the TMC4210 or with the TMC2660, take away the chip related jumpers. Then, the SPI interface of the TMC4210 respectively of the TMC2660 will be led through to the serial peripheral interface connector on the board (see chapter 3.1.2.5.2). The external microcontroller can be connected.

In case the microcontroller may implement also the motion control function, connect the Step/Dir In connector, too. Afterwards, the microcontroller can send step and direction signals to the stepper motor driver TMC2660.

MOTION CONTROLLER

Jumper	Label	Description
Select microcontroller for TMC4210	TMC4210_SPI	Set all jumpers to select the onboard microcontroller. Remove all jumpers to select an external microcontroller.
Select microcontroller for TMC2660	TMC2660_SPI	Set all jumpers to select the onboard microcontroller. Remove all jumpers to select an external microcontroller.

Table 3.10 Select microcontroller by jumper.



Figure 3.9 Jumper setting for normal operation.

3.1.3.5 External Step/Dir Generator

Use the Step/Dir In connector and let the jumpers plugged (see Figure 3.9). The microcontroller on the board can be used for configuration.

3.1.4 LEDs

The evaluation board has four LEDs:

- The power LED indicates that the on-board +5V digital supply is available.
- LED1 is connected to the microcontroller and indicates the heartbeat of the evaluation board.
- LED2 is connected to a microcontroller output, too. It is not programmed and can be used customer specific.
- The stallGuard2 LED indicates a motor stall.

LEDS OF EVALUATION BOARD

Label	Color	Description
Power	orange	Indicates, if +5V digital power supply is available.
LED1	yellow	This LED shows the heartbeat of the module. It is connected to pin 59 of the microcontroller. The function of the LED can be changed by software.
LED2	yellow	This LED is connected to pin 58 of the microcontroller. The function of the LED can be selected by software.
stallGuard	red	This LED indicates a motor stall. The LED is connected to pin 38 of the TMC2660.

Table 3.11 LEDs



Figure 3.10 LEDs of TMC4210+TMC2660-EVAL

3.1.5 Chopper Test Points

Chopper cycles can be measured with an oscilloscope. Therefore, use the second pins of the current setting connectors as test points.



Figure 3.11 Chopper test points

Label	Description
SRA	Bridge A sense resistor voltage
SRB	Bridge B sense resistor voltage

3.1.5.1 Current Sense Resistor Inputs (SRA and SRB)

The screenshots in this chapter show typical microstep waves and chopper cycles measured on the pins SRA and SRB. The area between the white broken line and the white line marked with a red 2 corresponds to one microstep. The chopper cycles of the two phases are nearly the same, but shifted.

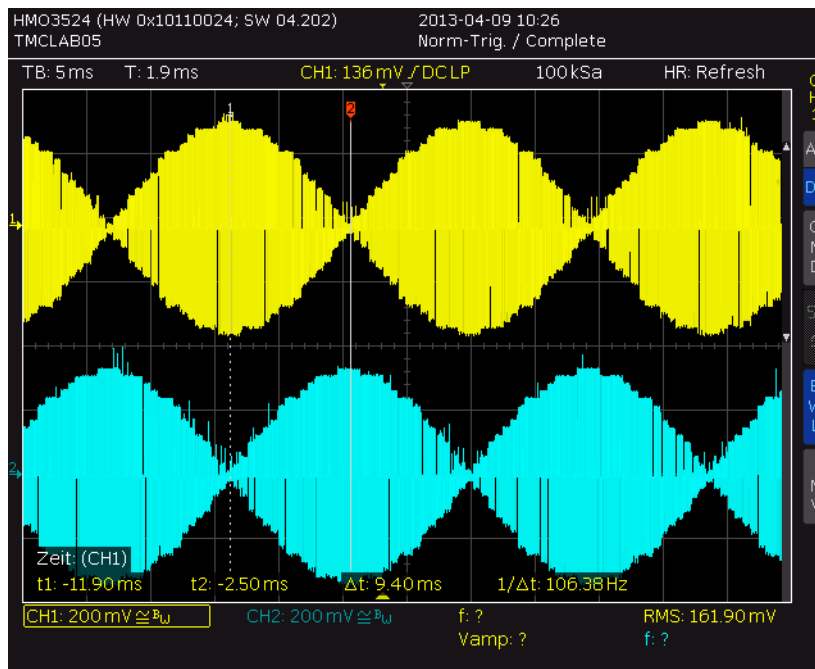

Figure 3.12 Oscilloscope screen shot: microsteps

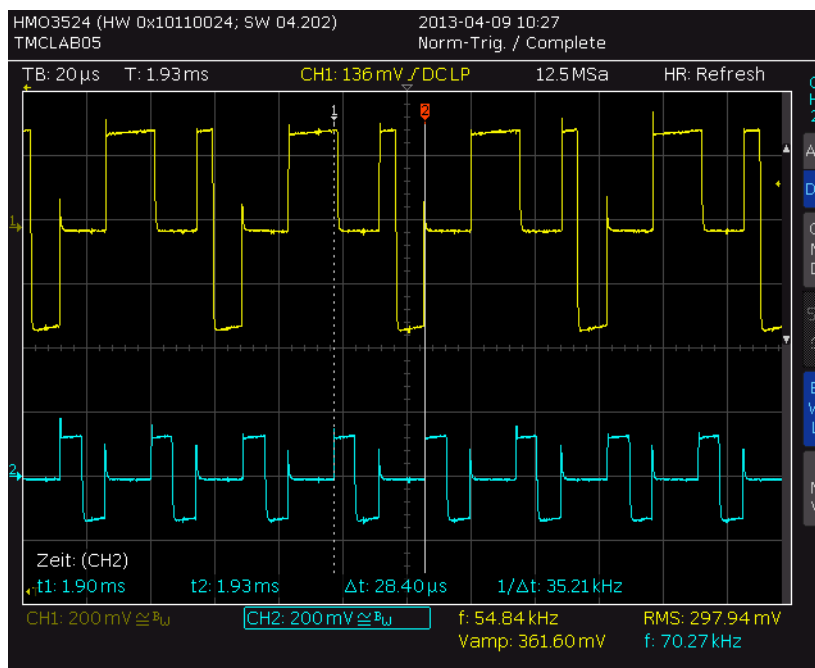

Figure 3.13 Oscilloscope screen shot: chopper cycles

4 Operational Ratings

The operational ratings shown below should be used as design values. The maximum power supply current depends on the used motors and the supply voltage.

Do not exceed the maximum values during operation! Otherwise the MOSFETs or the suppressor diode may be damaged!
See the motor coil output current limits copied from *TMC2660 datasheet* for short time and continuous motor current ratings.

Symbol	Parameter	Min	Typ	Max	Unit
VCC	Power supply voltage for operation	10	12-24	29	V
+5V	Output of internal switch regulator		5	5.1	V
I_{SUPPLY}	Power supply current (a 1A lab supply will do for reduced motor power)			2.8	A
T_{ENV}	Environment temperature at rated current (no forced cooling required)		20	50	°C
I_{OC}	Output current, RMS per motor coil, $\leq 40\text{kHz}$ chopper, fastest slope running >4 fullsteps/s			2.2	A
	duty cycle 2s on 6s off			2.8	
	standstill, single coil on (halfstep position) *)			2.4	

Table 4.1 General operational ratings of the module

*) The standstill specification refers to a stepper motor stopped at a high current. Normally, standstill current should be reduced to a value far below the run current to reduce motor heating.

Hint:

The board firmware starting from Version V1.02 automatically reduces the motor current to a maximum of 15, when the standstill flag of the driver becomes active. This prevents the standstill current rating to be exceeded, especially when $vsense=0$ and when jumper is plugged. However, the function is independent of $vsense$ and jumper settings!

5 Functional Description

Figure 5.1 shows the main parts of the evaluation board. Communication interfaces are RS485, USB, and CAN. The RS232 interface is an assembly option. The related transceiver can be retrofitted.

The board comes with a PC based software for evaluation purposes. Communication traffic is kept low since all time critical operations, e.g. ramp calculation, are performed on-board. Full remote control of the device with feedback is possible.

THE TMC4210+TMC2660-EVAL CONTAINS THE FOLLOWING MAIN COMPONENTS

- ARM Cortex-M0 processor Core S3FN41F microcontroller with built-in up to 256 Kbytes program flash memory and up to 32 Kbytes SRAM. Processor is equipped with crystal (more precision for USB communication).
- TMC4210 highly integrated single axes stepper motor controller including diagnostics and protection.
- TMC2660 advanced stepper motor driver IC with stallGuard2 and coolStep with integrated MOSFET driver transistors (4x power MOSFETs for 2-phase bipolar stepper motor).
- RS485 and USB transceivers.
- On-board switching and linear voltage regulators for supply of on-board digital circuits
- Left switch, right switch, and home switch

SPI and Step/Dir signals of TMC4210 and TMC2660 can be led through to plugs on the board in order to connect external parts, such as microcontroller, motion controller, or stepper motor driver.

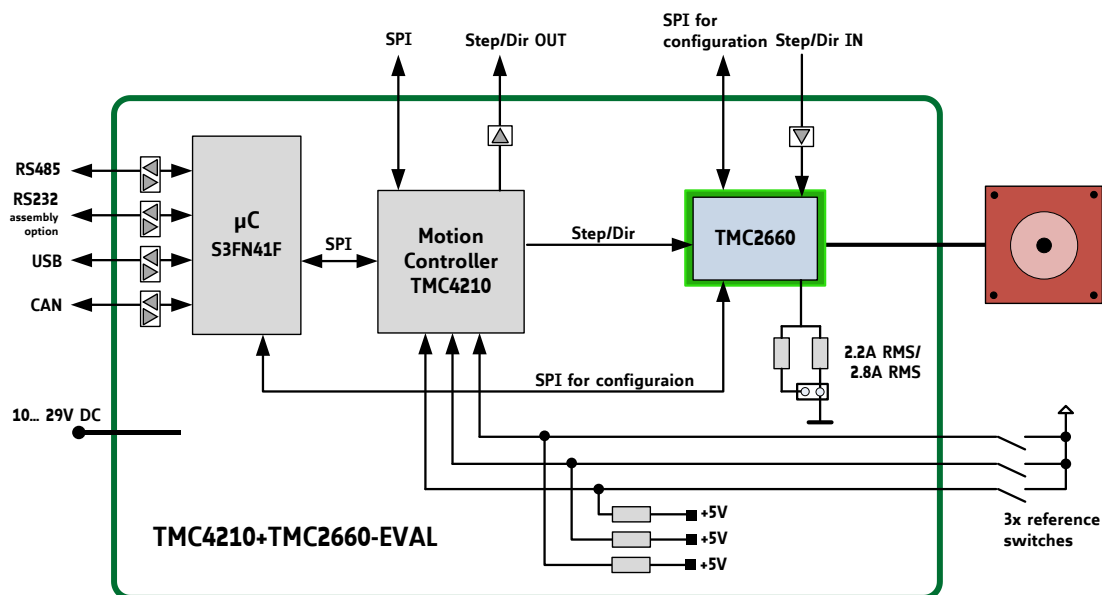

Figure 5.1 Main parts of the evaluation board

6 Getting Started – How to Connect the Board

YOU NEED

- Evaluation board
- Stepper motor (motor current: up to 2.8A RMS)
- Interface: USB, RS485, or CAN
- Power supply +10... 29V DC,
- *TMC4210+TMC2660-EVAL* software and PC
- Cables for interface, motor, and power

PRECAUTIONS

- Do not mix up connections or short-circuit pins.
- Avoid bounding I/O wires with motor wires.
- Do not exceed the maximum power supply of +29V DC!
- DO NOT CONNECT OR DISCONNECT THE MOTOR WHILE POWERED!
- START WITH POWER SUPPLY OFF!

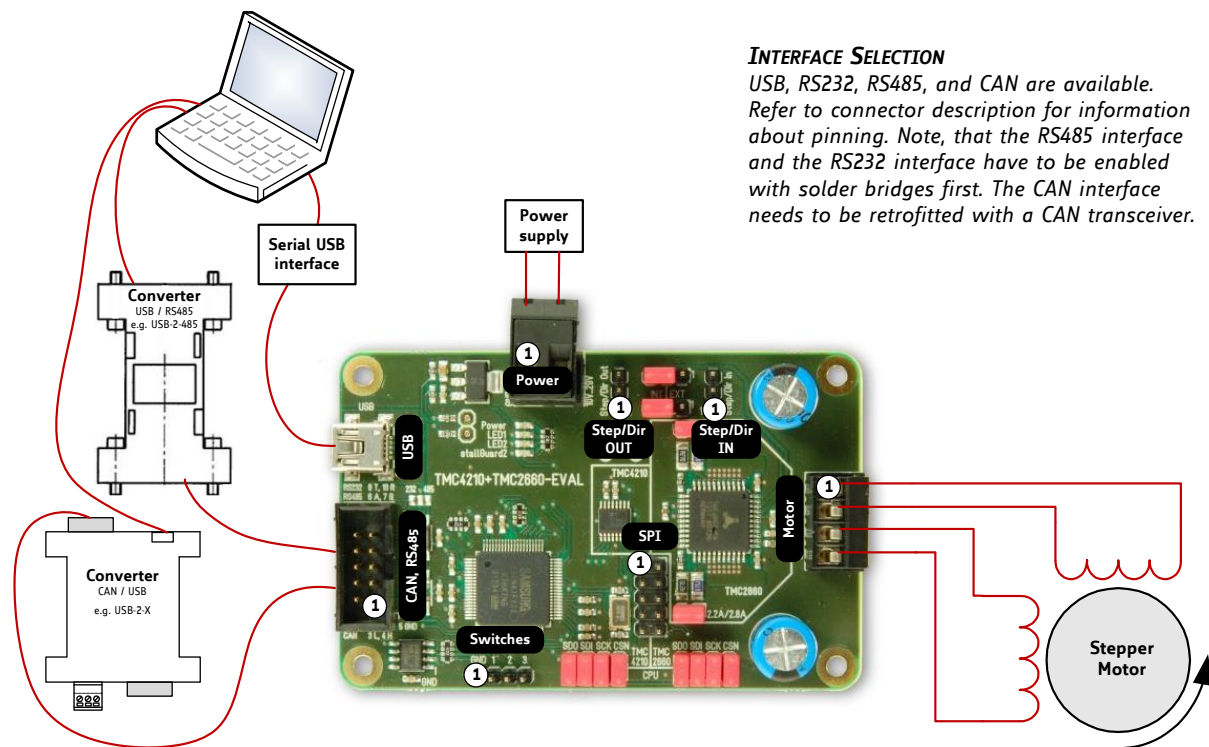

Figure 6.1 Getting started

STARTING UP

1. Connect interface.
2. Connect motor.
3. Connect power supply of the evaluation board.
4. Turn power ON. The orange LED near the power supply glows now. Further, LED1 indicates the heartbeat of the board (blinks). The motor is powered but in standstill now. *If this does not occur, turn power OFF. Check your connections and power supply!*
5. If you connect the USB the first time, you will be asked for the virtual com port configuration file that is required for configuration of a virtual com port for your evaluation board. For Windows systems use the *TMC4210.inf* configuration file (available on www.trinamic.com).
6. Download the file *TMC4210Eval.exe*. Open it with a double click.
7. Push the button *Open*. The board will be detected now.
8. *Caution:* make sure the current setting matches to your motor. (Refer to chapter 6.1.)
9. Start examinations with the PC software (refer to chapter 6.1).

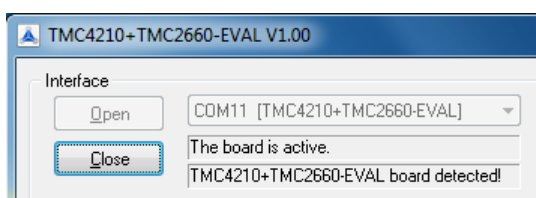

Figure 6.2 Interface dialogue of evaluation board software

6.1 Motor Current Setting

Before operating your motor, please make sure that the current setting matches to your motor. As the TMC2660 allows driving high motor currents, special care has to be taken not to exceed the continuous power dissipation rating of the TMC2660 as specified in the TMC2660 datasheet. Please consider the following maximum ratings:

TMC2660 Parameter		Symbol	Min	Max	Unit
Output current, RMS per coil, $T_A \leq 50^\circ\text{C}$ 50cm ² board with sample layout, $\leq 40\text{kHz}$ chopper, fastest slope	running >4 fullsteps/s	I_{OC}		2.2	A
	duty cycle 2s on 6s off			2.8	
	standstill, single coil on (halfstep position) *)			2.4	

Using the internal sine wave table, which has amplitude of 248, the RMS motor current can be calculated by:

$$I_{RMS} = \frac{CS + 1}{32} * \frac{V_{FS}}{R_{SENSE}} * \frac{1}{\sqrt{2}}$$

where:

CS is the effective current scale setting as set by the CS bits and modified by coolStep. The effective value ranges from 0 to 31.

V_{FS} is the sense resistor voltage at full scale, as selected by the VSENSE control bit.

Parameter	Description	Setting	Comment
CS	<i>Current scale.</i> Scales both coil current values as taken from the internal sine wave table or from the SPI interface. For high precision motor operation, work with a current scaling factor in the range 16 to 31, because scaling down the current values reduces the effective microstep resolution by making microsteps coarser. This setting also controls the maximum current value set by coolStep.	0 ... 31	Scaling factor: 1/32, 2/32, ... 32/32
VSENSE	Allows control of the sense resistor <i>voltage range</i> or adaptation of one electronic module to different maximum motor currents.	0	310mV
		1	165mV

Pay special attention concerning the thermal design and current limits imposed by the motor current setting!

Be sure to reduce the current to a value at or below the maximum standstill current limits. This is important due to thermal restrictions for continuous current in a single bridge. The worst case is standstill in a half step position where one bridge has 0 current and the other bridge has *RMS value* * $\sqrt{2}$ current.

The following table shows example values for different conditions.

CURRENT SETTING ON TMC4210+TMC2660 EVALUATION BOARD					
Conditions	Vsense=1, Rsense=75mΩ	Vsense=1, Rsense=75mΩ 270mΩ	Vsense=0, Rsense=75mΩ	Vsense=0, Rsense=75mΩ 270mΩ	<i>Rsense=75mΩ 270mΩ means that Jumpers K301 and K303 are plugged</i>
Effective Sense Resistor	0.075	0.059	0.075	0.059	Ω
Vsense	165	165	310	310	mV
Current Scale CS:	RMS motor current Current [A]				
0	0.0	0.1	0.1	0.1	
1	0.1	0.1	0.2	0.2	
2	0.1	0.2	0.3	0.4	
3	0.2	0.2	0.4	0.5	
4	0.2	0.3	0.5	0.6	
5	0.3	0.4	0.5	0.7	
6	0.3	0.4	0.6	0.8	
7	0.4	0.5	0.7	0.9	
8	0.4	0.6	0.8	1.1	
9	0.5	0.6	0.9	1.2	
10	0.5	0.7	1.0	1.3	
11	0.6	0.7	1.1	1.4	
12	0.6	0.8	1.2	1.5	
13	0.7	0.9	1.3	1.6	
14	0.7	0.9	1.4	1.8	
15	0.8	1.0	1.5	1.9	
16	0.8	1.1	1.6	2.0	
17	0.9	1.1	1.6	2.1	
18	0.9	1.2	1.7	2.2	
19	1.0	1.2	1.8	2.3	
20	1.0	1.3	1.9	2.5	
21	1.1	1.4	2.0	2.6	
22	1.1	1.4	2.1	2.7	
23	1.2	1.5	2.2	2.8	
24	1.2	1.6	2.3	2.9	
25	1.3	1.6	2.4	3.0	
26	1.3	1.7	2.5	3.2	
27	1.4	1.7	2.6	3.3	
28	1.4	1.8	2.6	3.4	
29	1.5	1.9	2.7	3.5	
30	1.5	1.9	2.8	3.6	
31	1.6	2.0	2.9	3.7	

1,8	Standby current reduction is mandatory above 1.7A RMS setting, also reduce current when running <=4 fullsteps/second
2,3	Setting above 2.2A RMS only for duty cycle limited operation, check driver temperature
3,0	Setting not allowed, current is too high

7 Evaluation Software

The evaluation software *TMC4210Eval.exe* is intended for customers who design own PCBs with the TMC4210 and/or the stepper motor driver TMC2660. In order to understand the settings, the datasheets of the ICs need to be referenced. The software is designed for adjusting and testing all settings by allowing direct register access.

7.1 The Main Window

After starting the software the main window will open up (Figure 7.1). First, click the *Open* button. If the connection to the evaluation board is established successfully, the message *The board is active* will be displayed. If the message *The board does not respond* is displayed, please check the power supply and the connection to your PC again.

The TMC4210 status register is displayed in the *TMC4210 Status Bits* section on the right side. With the control fields in the *Motor* section, the motor can be run. Just enter all necessary parameters and click the *Go* button. You can stop a motor by clicking the *Stop* button. With the *Ramp Mode* selection the mode of operation can be chosen.

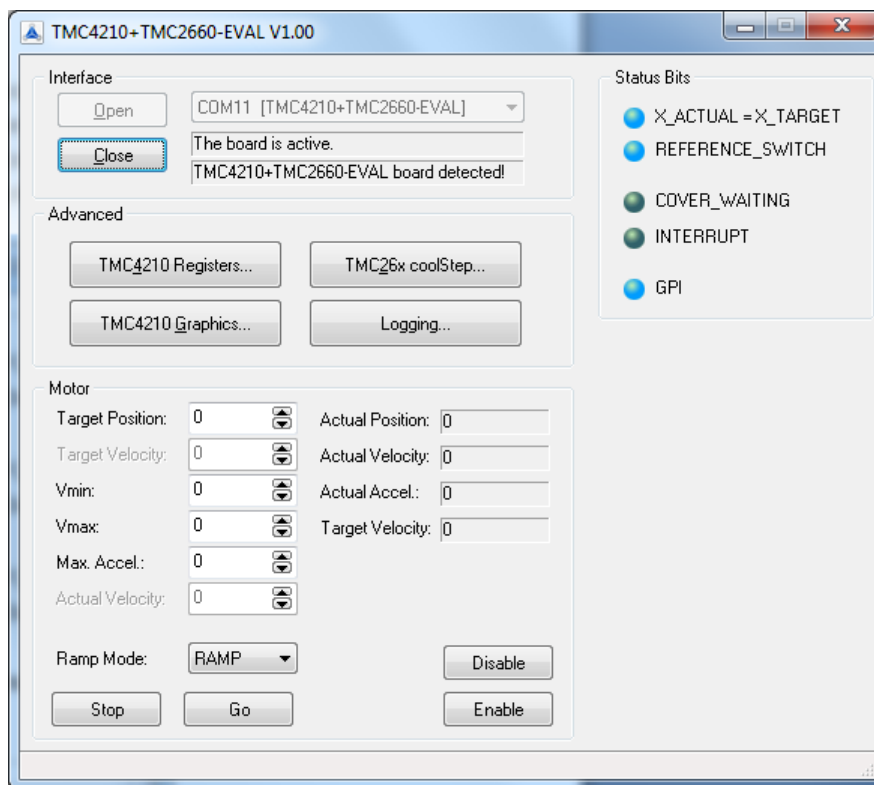

Figure 7.1 The main window

7.1.1 Ramp Mode Selection

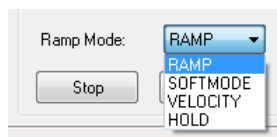

Figure 7.2 Ramp mode selection

PROCEED AS FOLLOWS TO RUN A MOTOR:

- Select a ramp mode.
- Fill in the other necessary parameters.
- Start the motor with the *Go* button.

You will find explanations of all parameters in the *TMC4210 data sheet*.

RAMP MODES PROVIDED BY TMC4210

Mode	Function
<i>ramp_mode</i>	Default mode for positioning applications with trapezoidal ramp. This mode is provided as default mode for positioning tasks.
<i>soft_mode</i>	Similar to <i>ramp_mode</i> , but with soft target position approaching. The target position is approached with exponentially reduced velocity. This feature can be useful for applications where vibrations at the target position have to be minimized.
<i>velocity_mode</i>	Mode for velocity control applications, change of velocities with linear ramps. This mode is for applications, where a stepper motor has to be driven precisely with constant velocity.
<i>hold_mode</i>	The velocity is controlled by the microcontroller, motion parameter limits are ignored. This mode is provided for motion control applications, where the ramp generation is completely controlled by the microcontroller.

Table 7.1 TMC429 ramp modes

7.1.2 Examples**7.1.2.1 RAMP Mode**

Figure 7.3 RAMP mode

First, set the ramp mode to *RAMP*. Then enter the following parameters:

- Target Position: 100000
- Vmin: 1
- Vmax: 500
- Max Accel.: 150

Click the *Go* button. Now, the motor will be running until position 100000 is reached. After that, enter zero as *Target Position* and click the *Go* button again. The motor will run back to position zero.

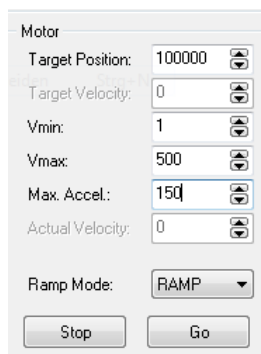
You can also try to change the position *on the fly* whilst the motor is running. Just enter a different position, click the *Go* button and see how the motor reacts. Also open the graphics window (Chapter 7.2) and watch the ramps.

In *RAMP* and *SOFTMODE* the *Vmin* parameter must not be zero because otherwise the target position sometimes cannot be reached.

Some other parameters which are not displayed in the main window are calculated and set up automatically according to the acceleration parameter.

7.1.2.2 VELOCITY Mode

Figure 7.4 VELOCITY mode

When using *VELOCITY* mode, you can enter the acceleration and the *Vmax* parameter. The motor is then accelerated to that velocity and keeps running constantly until you change the velocity and click the *Go* button again. The motor will then be accelerated or decelerated to the new velocity using the acceleration parameter you have entered.

7.1.2.3 HOLD Mode

Motor

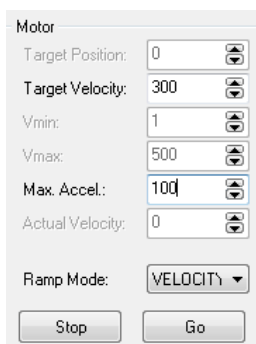
Target Position: 0

Target Velocity: 100

Vmin: 1

Vmax: 500

Max. Accel.: 100

Actual Velocity: 400

Ramp Mode: HOLD

Stop Go

If you set the ramp mode to *HOLD*, you can only enter the *actual velocity* parameter, click the *Go* button and control the velocity directly.

Figure 7.5 HOLD mode

7.2 Graphic Display

The graphic display window (Figure 7.6) shows the driving ramp of the stepper motor. The following values are displayed:

Green	Actual position
Red	Actual velocity
Blue	Actual acceleration
Yellow	Target velocity

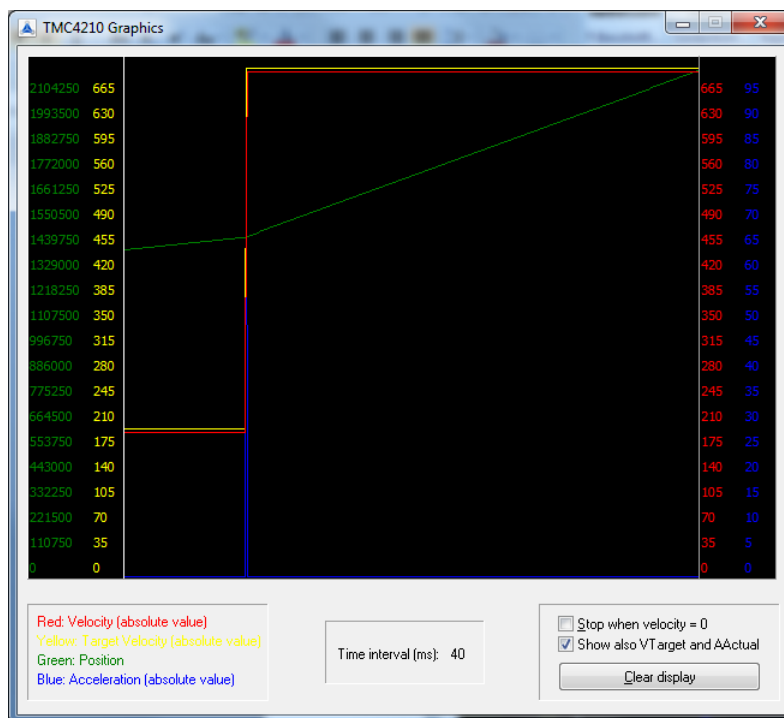

Figure 7.6 graphic display window

EXPLANATIONS

- The values are shown as absolute values. Therefore, negative velocities will also be shown as positive values.
- Please note that this is only a rough and not an exact diagram.
- All curves are cleared by clicking the *Clear display* button.
- The value *Time interval [ms]* shows the time between two pixels on the X-axis. This value mainly depends on the performance of the PC and will be slower when the register window of the evaluation board software is open (the display then gets slower because more values are queried from the evaluation board).
- The scales of the Y-axis are automatically adapted to fit entire curves. The curves are also displayed one pixel against each other for a better view.
- If *Stop when velocity = 0* is activated the display will be stopped when the velocity is zero.

7.3 TMC4210 Register Dialog

By clicking the *TMC4210 Registers* button the register window opens and gives you access to every TMC4210 register. This dialog contains two tabs where all registers are displayed, sorted by functional blocks.

Please read more about the registers in the *TMC4210 data sheet*.

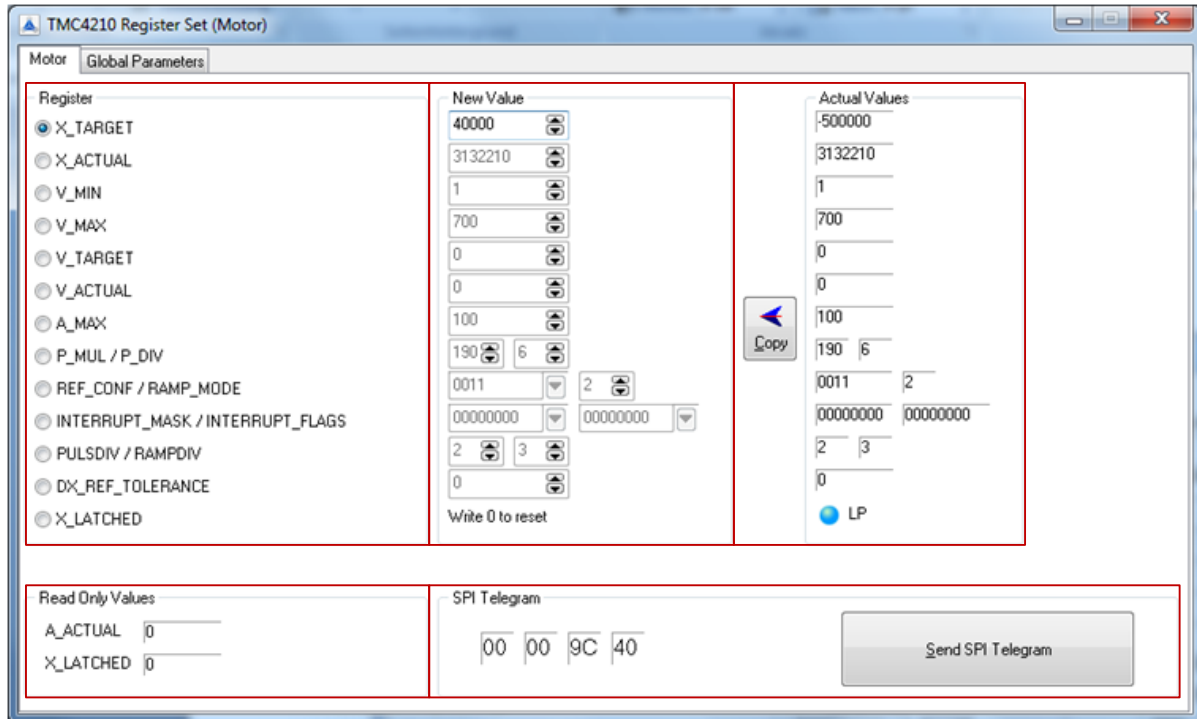

Figure 7.7 The register window showing the *Motor* tab

7.3.1 Motor Tab

On the motor tab, all registers belonging to the motor are displayed (Figure 7.7). In the *Actual Values* and *Read Only Values* sections, the contents of all readable registers are displayed. These values are updated permanently.

To change the content of a register, first click on the name in the *Register* section. Then change the value in the appropriate edit field in the *New Value* section. You can also copy the actual values into the edit fields by clicking the *Copy* button.

The SPI telegram for setting the selected register to the desired value is shown in the *SPI Telegram* section. Click the *Send SPI Telegram* button to send it to the evaluation board. Now, the new value is valid.

7.3.2 TMC4210 Global Parameter Tab

This tab (Figure 7.8) shows all TMC4210 global parameter registers. To change a register, select it in the *Registers* section and fill in a new value in the *New Value* section. With the *Copy* button you can copy the actual values into the edit fields. For executing new values click the button *Send SPI Telegram*.

In the *Actual Values* section the actual settings of the global registers are shown and updated permanently. Reference switch flags are shown in the related section on the left side of the window.

In the *SPI Telegram* section, the SPI telegram for a chosen value is shown. Click the *Send SPI Telegram* button to send it to the evaluation board, and the value will be set.

Further, it is possible to enter SPI telegrams directly. Therefore, write the binary code into the input fields in the *SPI Direct* section.

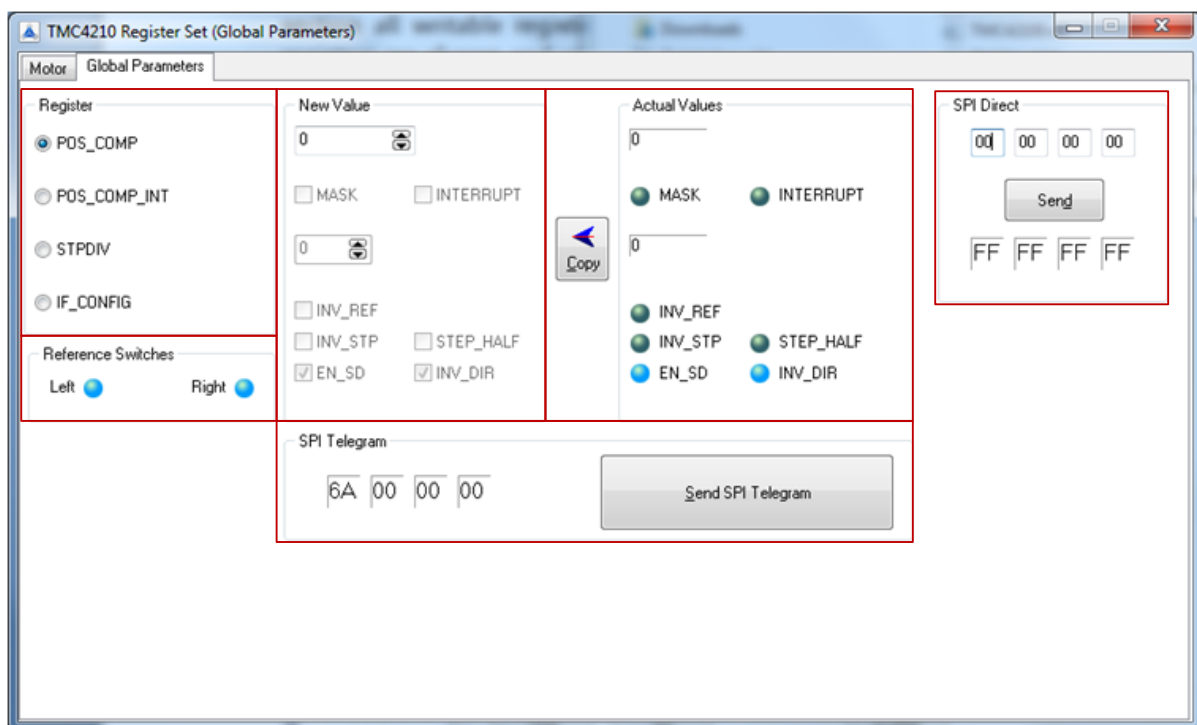

Figure 7.8 The register window showing the *Global Parameters* page

7.3.2.1 Interrupts

For setting up a position compare interrupt and enabling it, the `POS_COMP` and the `POS_COMP_INT` registers have to be used. Proceed as follows:

1. Choose the register `IF_CONFIG`. Click *Send SPI Telegram*.
2. Choose the register `POS_COMP_INT` and set ticks at `MASK` and `INTERRUPT`. Click *Send SPI Telegram*.
3. Choose the register `POS_COMP` and write a position value for the interrupt in the *New Value* field. Click *Send SPI Telegram*.

Now, the interrupt flag will be set, if the motor passes the interrupt position. To reset the interrupt flag, choose the register `POS_COMP_INT` and send the SPI telegram again by just clicking *Send SPI Telegram*.

7.3.2.2 Inverting Reference Switches

For inverting the reference switches choose the register `IF_CONFIG` and set a tick at `INV_REF`. Thereafter, click *Send SPI Telegram*. Now, the reference switches are inverted.

7.4 TMC2660 Registers

A click at the *TMC26x coolStep* button on the main window opens the dialogue for the TMC2660 driver registers (Figure 7.9). Here, all values for the driver control (DRVCTRL), the chopper (CHOPCONF), coolStep (SMARTEN), stallGuard2 (SGCSCONF), and the driver configuration (DRVCONF) can be set and read out. Further, the status flags of the driver can be read out (DRVSTATUS). The last tab offers a graph with stallGuard2 and coolStep readout values.

Please read more about the registers in the TMC2660 data sheet.

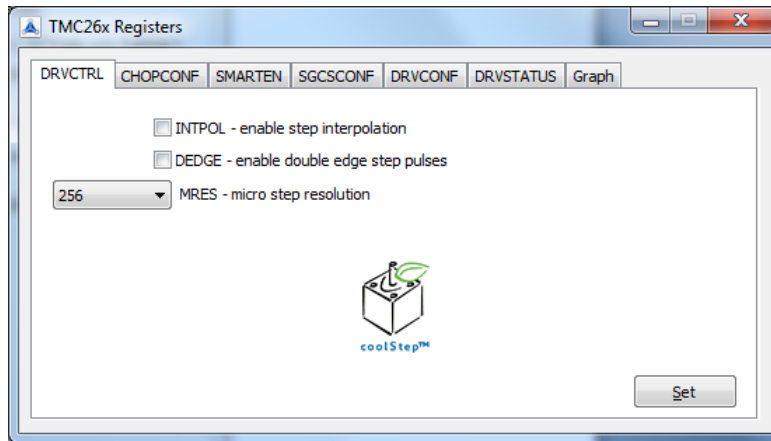

Figure 7.9 TMC2660 register dialog

7.4.1 DRVCTRL Tab

Here, step interpolation and double edge step pulses can be enabled and disabled (Figure 7.9). Further, the microstep resolution of the drive can be set here. The highest resolution is 256 μ steps per fullstep. This is the default setting.

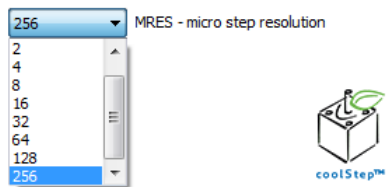

Figure 7.10 Choose microstep resolution

7.4.2 CHOPCONF Register Tab

Current into the motor coils is controlled using a cycle-by-cycle chopper mode. Two chopper modes are available with the TMC2660: a traditional constant off-time mode and the new standard spreadCycle™ mode. spreadCycle offers smoother operation and greater power efficiency over a wide range of speed and load.

The CHOPCONF register contains all parameters which concern the chopper configuration. Important parameters are for configuration of the chopper hysteresis in spreadCycle chopper mode. Other parameters are for blank time selection, random off time, and driver off time setting.

In case standard spreadCycle mode is to be used, the parameters for chopper hysteresis on the left side of the tab are active and can be set.

The other possibility is to use a conventional constant off time chopper. If this chopper mode is selected, the fields on the right side of the window (*sine wave offset* and *fast decay time*) become active and can be configured. Further the current comparator can be disabled.

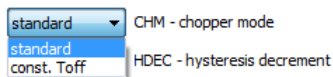

Figure 7.11 Chopper mode selection

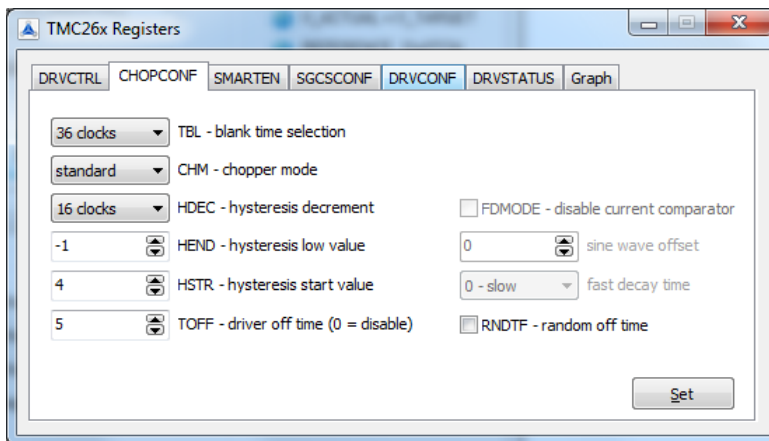

Figure 7.12 CHOPCONF register tab

7.4.3 SMARTEN Register Tab

The SMARTEN register tab contains all parameter settings which can be configured for energy saving coolStep operation of the stepper driver system. For evaluating values choose them and click *Set*. Before tuning coolStep, first tune the stallGuard2 threshold level SGT, which affects the range of the load measurement value SG, which can be read out (see DRVSTATUS tab). coolStep uses SG to operate the motor near the optimum load angle of +90°.

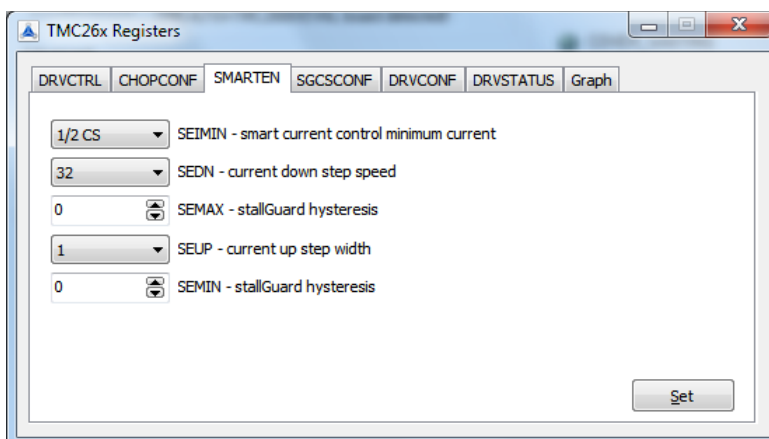

Figure 7.13 SMARTEN register tab

7.4.4 SGSCONF Register Tab

This tab is used for configuring the stallGuard2 feature. stallGuard2 provides an accurate measurement of the load on the motor. It can be used for stall detection as well as other uses at loads below those which stall the motor, such as coolStep load-adaptive current reduction.

Like on the other tabs of the configuration tool, just write a value in an input field and click *Set*. Further, the tab provides a useful tool for RMS and peak current calculation which is based on sense resistor values.

ATTENTION

At maximum motor load, the SG value (see DRVSTATUS tab) goes to zero or near to zero. This corresponds to a load angle of 90° between the magnetic field of the coils and magnets in the rotor. This also is the most energy-efficient point of operation for the motor.

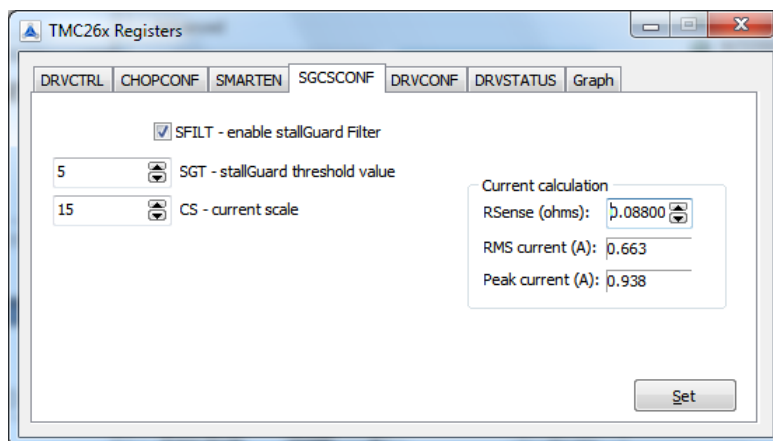

Figure 7.14 SGSCONF register tab

7.4.5 DRVCONF Register Tab

This tab is used for driver configuration. The use of the DRVCTRL register depends on the state of the SDOFF mode bit:

- SPI Mode* SDOFF bit is set, the STEP/DIR interface is disabled, and DRVCTRL is the interface for specifying the currents through each coil.
- STEP/DIR Mode* SDOFF bit is clear, the STEP/DIR interface is enabled, and DRVCTRL is a configuration register for the STEP/DIR interface.

Like on the other tabs just write a value in an input field and click *Set*.

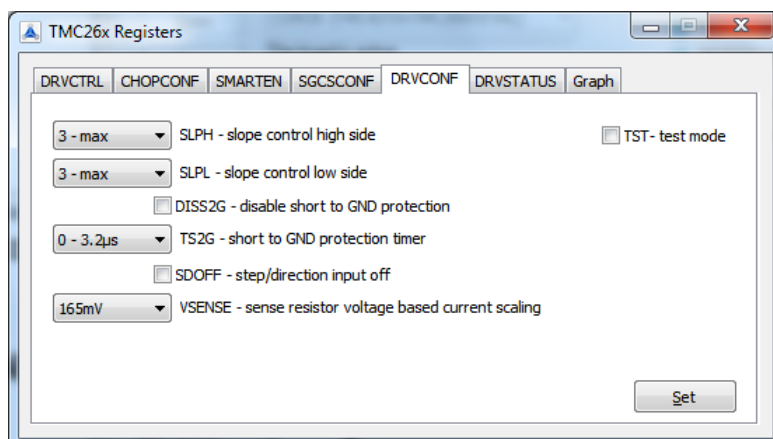

Figure 7.15 DRVCONF register tab

7.4.6 DRVSTATUS Register Tab

On this tab, the status of all driver read out bits is shown. Further, the actual stallGuard2 value and the actual SE value (coolStep current value) can be read out. The microstep position is shown also. With the reset button, S2GA an S2GB (short to GND) can be reset.

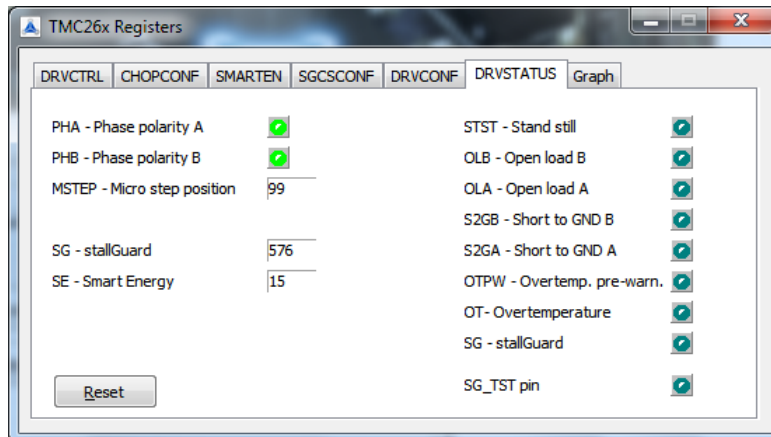

Figure 7.16 DRVSTATUS register tab

7.4.7 Graph Tab

This dialogue is designed for adjusting stallGuard2 and coolStep. The coolStep current is shown in red and the stallGuard2 load in blue. The coolStep current value increases/decreases adequate to the measured load on the axis. This way, energy savings can be optimized.

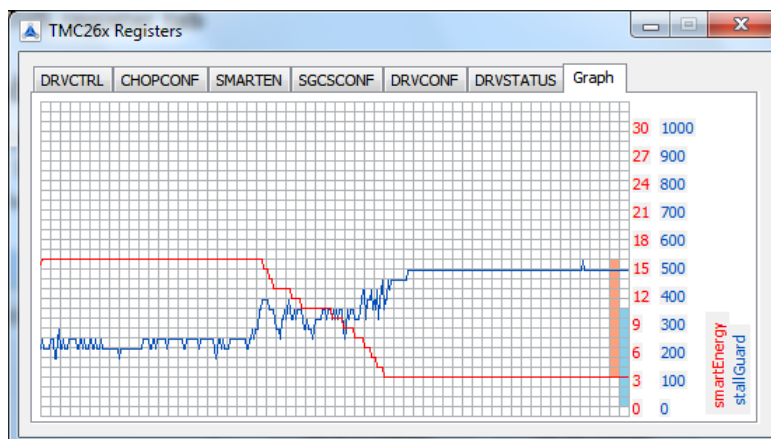

Figure 7.17 Graph tab for reading out the SG value and the related current consumption when using coolStep

7.5 Logging Dialog

The *Logging* dialog can be used to store values during motor rotation. Proceed as follows:

1. Click the button with three points on the right side of the window. Then, write in a file name and choose a storage location.
2. Choose parameters for storing, each with a tick.
3. Click *Start logging*. Now, the polled values are stored directly into a .csv file.
4. Click *Stop logging* to end the polling.
5. Now, all values can be read out using Excel. Excel opens up after a double click at the stored file.

In case it is desired to add further polled values to an existing file, tick *Append to log file*.

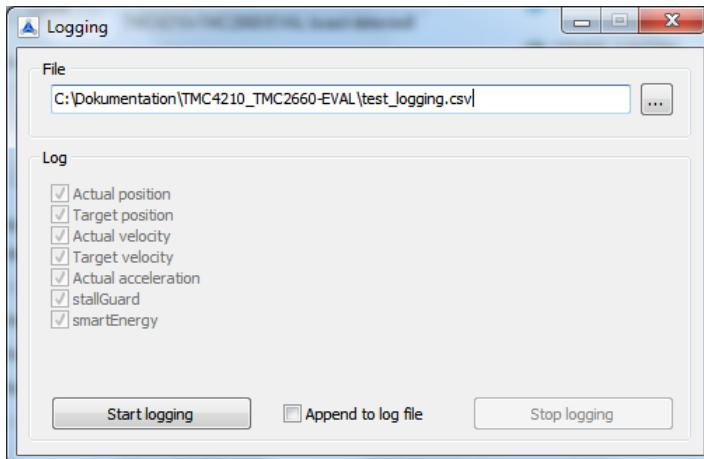

Figure 7.18 Logging dialog

TIME	X_TARGET_1	X_ACTUAL_1	V_TARGET_1	V_ACTUAL_1	A_ACTUAL_1	SMARTENERGY	STALLGUARD_1
2	421	-5000000	5976850	2047	2047	0	3 480
3	437	-5000000	5978693	2047	2047	0	3 480
4	453	-5000000	5980532	2047	2047	0	3 480
5	468	-5000000	5982260	2047	2047	0	3 480
6	484	-5000000	5984035	2047	2047	0	3 480
7	499	-5000000	5985885	2047	2047	0	3 480
8	515	-5000000	5987700	2047	2047	0	3 480
9	531	-5000000	5989483	2047	2047	0	3 480
10	546	-5000000	5991194	2047	2047	0	3 480
11	562	-5000000	5992956	2047	2047	0	3 480
12	577	-5000000	5994767	2047	2047	0	3 480
13	577	-5000000	5996520	2047	2047	0	3 480
14	593	-5000000	5998184	2047	2047	0	3 480
15	609	-5000000	5999952	2047	2047	0	3 480
16	624	-5000000	6001726	2047	2047	0	3 480
17	640	-5000000	6003522	2047	2047	0	3 480
18	655	-5000000	6005296	2047	2047	0	3 480
19	671	-5000000	6006990	2047	2047	0	3 480
20	687	-5000000	6008740	2047	2047	0	3 480
21	702	-5000000	6010593	2047	2047	0	3 480
22	718	-5000000	6012343	2047	2047	0	3 480
23	718	-5000000	6014174	2047	2047	0	3 480
24	733	-5000000	6015998	2047	2047	0	3 480

Figure 7.19 Logged values shown in Excel

8 Life Support Policy

TRINAMIC Motion Control GmbH & Co. KG does not authorize or warrant any of its products for use in life support systems, without the specific written consent of TRINAMIC Motion Control GmbH & Co. KG.

Life support systems are equipment intended to support or sustain life, and whose failure to perform, when properly used in accordance with instructions provided, can be reasonably expected to result in personal injury or death.

© TRINAMIC Motion Control GmbH & Co. KG 2013-2014

Information given in this data sheet is believed to be accurate and reliable. However neither responsibility is assumed for the consequences of its use nor for any infringement of patents or other rights of third parties, which may result from its use.

Specifications are subject to change without notice.

All trademarks used are property of their respective owners.



9 Revision History

Version	Date	Author	Description
1.00	2013-OCT-30	SD	Initial version
1.01	2014-APR-28	SD	Chapter 6.1 (motor current setting) added.
1.02	2014-NOV-27	BD	Added absolute maximum ratings and hint for firmware standstill current reduction in firmware version 1.02
1.03	2015-MAR-18	BD	Corrected VSENSE in current table

Table 9.1 Document revision

10 References

[TMC4210] TMC4210 Datasheet
[TMC2660] TMC2660 Datasheet

Refer to www.trinamic.com.