

**ebm-papst St. Georgen GmbH & Co. KG**

Hermann-Papst-Str. 1

D-78112 St. Georgen

Phone +49 (0) 7724 81-0

Fax +49 (0) 7724 81-1309

info2@de.ebmpapst.com

www.ebmpapst.com

Nominal data

Type	412 J	
Nominal voltage	VDC	12
Nominal voltage range	VDC	8 .. 14
Speed (rpm)	min ⁻¹	10300
Power consumption	W	2.4
Min. ambient temperature	°C	-20
Max. ambient temperature	°C	70
Air flow	m ³ /h	19
Sound power level	B	5.5
Sound pressure level	dB(A)	39

ml = Max. load · me = Max. efficiency · fa = Free air · cs = Customer specification · ce = Customer equipment
Subject to change



Technical description

Weight	0.050 kg
Dimensions	40 x 40 x 25 mm
Impeller material	Glass-fiber reinforced PA plastic
Housing material	Glass-fiber reinforced PBT plastic
Airflow direction	Exhaust over struts
Direction of rotation	Counterclockwise, viewed toward rotor
Storage	Ball bearing
Service life L10 at 40 °C	60000 h
Service life L10 at maximum temperature	30000 h
Cable	Leads AWG 26, TR 64, stripped and tin-plated.
Motor protection	Protection against reverse polarity and blocked rotor.
Approval	VDE, CSA, UL



Product drawing

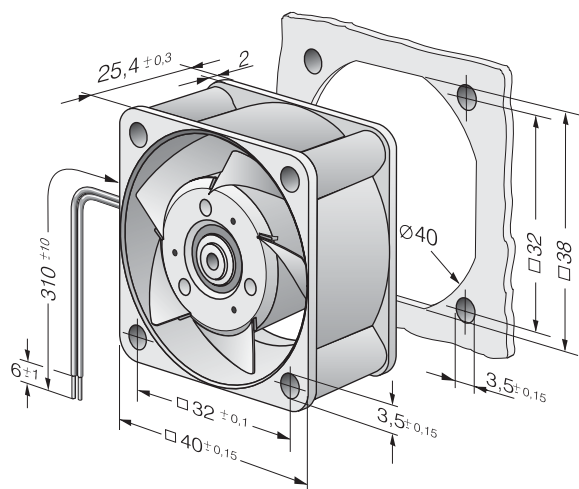

Curves: Air performance

