

2N4427
SILICON
NPN RF TRANSISTOR



TO-39 CASE

DESCRIPTION:

The CENTRAL SEMICONDUCTOR 2N4427 is a silicon NPN epitaxial planar RF transistor mounted in a hermetically sealed package designed for high frequency amplifier applications.

MARKING: FULL PART NUMBER

MAXIMUM RATINGS: ($T_A=25^\circ\text{C}$ unless otherwise noted)

	SYMBOL		UNITS
Collector-Base Voltage	V_{CBO}	40	V
Collector-Emitter Voltage	V_{CEO}	20	V
Emitter-Base Voltage	V_{EBO}	2.0	V
Continuous Collector Current	I_C	400	mA
Continuous Base Current	I_B	400	mA
Power Dissipation	P_D	1.0	W
Power Dissipation ($T_C=25^\circ\text{C}$)	P_D	3.5	W
Operating and Storage Junction Temperature	T_J, T_{stg}	-65 to +200	$^\circ\text{C}$

ELECTRICAL CHARACTERISTICS: ($T_A=25^\circ\text{C}$ unless otherwise noted)

SYMBOL	TEST CONDITIONS	MIN	MAX	UNITS
I_{CEV}	$V_{CE}=40\text{V}, V_{BE}=1.5\text{V}$		100	μA
I_{CEV}	$V_{CE}=12\text{V}, V_{BE}=1.5\text{V}, T_C=150^\circ\text{C}$		5.0	mA
I_{CEO}	$V_{CE}=12\text{V}$		20	μA
I_{EBO}	$V_{EB}=2.0\text{V}$		100	μA
BV_{CER}	$I_C=5.0\text{mA}, R_{BE}=10\Omega$	40		V
BV_{CEO}	$I_C=5.0\text{mA}$	20		V
$V_{CE(SAT)}$	$I_C=100\text{mA}, I_B=20\text{mA}$		0.5	V
h_{FE}	$V_{CE}=5.0\text{V}, I_C=100\text{mA}$	10	200	
h_{FE}	$V_{CE}=5.0\text{V}, I_C=360\text{mA}$	5.0		
f_T	$V_{CE}=15\text{V}, I_C=50\text{mA}, f=200\text{MHz}$	500		MHz
C_{ob}	$V_{CB}=12\text{V}, I_E=0, f=1.0\text{MHz}$		4.0	pF
G_{pe}	$V_{CC}=12\text{V}, P_{in}=100\text{mW}, f=175\text{MHz}$	10		dB
η	$V_{CC}=12\text{V}, P_{out}=1.0\text{W}, f=175\text{MHz}$	50		%
P_{in}	$V_{CC}=12\text{V}, P_{out}=1.0\text{W}, f=175\text{MHz}$		100	mW

2N4427
SILICON
NPN RF TRANSISTOR



TO-39 CASE - MECHANICAL OUTLINE

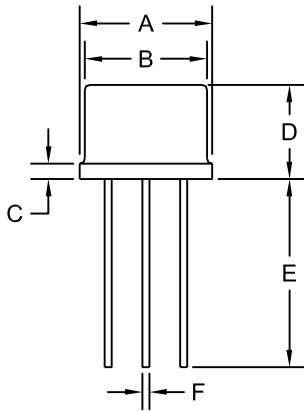

SYMBOL	DIMENSIONS		DIMENSIONS	
	INCHES		MILLIMETERS	
	MIN	MAX	MIN	MAX
A (DIA)	0.335	0.370	8.51	9.40
B (DIA)	0.315	0.335	8.00	8.51
C	-	0.040	-	1.02
D	0.240	0.260	6.10	6.60
E	0.500	-	12.70	-
F (DIA)	0.016	0.021	0.41	0.53
G (DIA)	0.200		5.08	
H	0.100		2.54	
I	0.028	0.034	0.71	0.86
J	0.029	0.045	0.74	1.14

TO-39 (REV: R1)

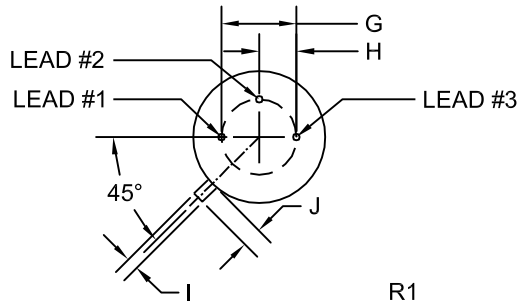

LEAD CODE:

- 1) Emitter
- 2) Base
- 3) Collector

MARKING: FULL PART NUMBER

R1 (4-June 2013)

2N4427
SILICON
NPN RF TRANSISTOR



TYPICAL ELECTRICAL CHARACTERISTICS

DC Current Gain

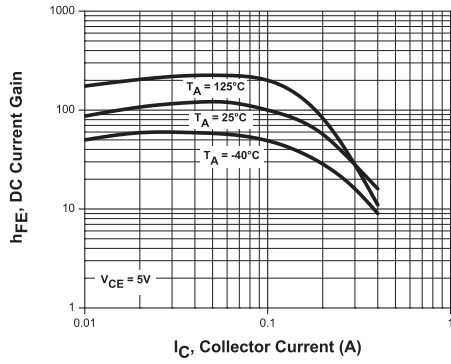

"ON" Voltage

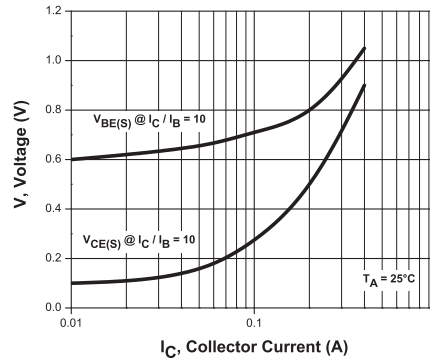

Capacitance

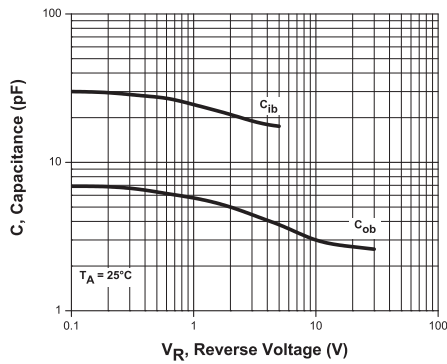

Safe Operating Area

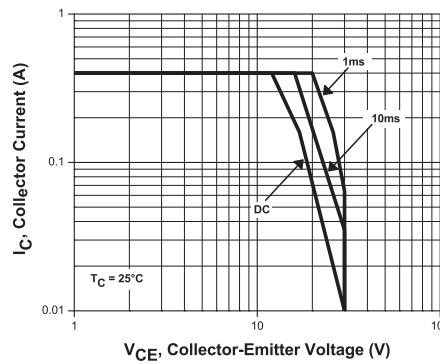

Power Derating

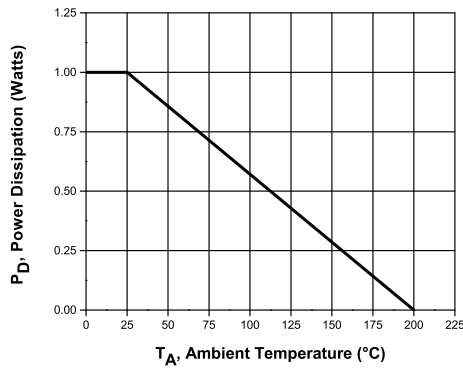

Current Gain-Bandwidth Product

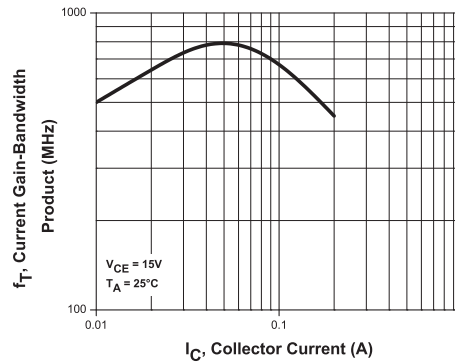

R1 (4-June 2013)

OUTSTANDING SUPPORT AND SUPERIOR SERVICES



PRODUCT SUPPORT

Central's operations team provides the highest level of support to insure product is delivered on-time.

- Supply management (Customer portals)
- Inventory bonding
- Consolidated shipping options
- Custom bar coding for shipments
- Custom product packing

DESIGNER SUPPORT/SERVICES

Central's applications engineering team is ready to discuss your design challenges. Just ask.

- Free quick ship samples (2nd day air)
- Online technical data and parametric search
- SPICE models
- Custom electrical curves
- Environmental regulation compliance
- Customer specific screening
- Up-screening capabilities
- Special wafer diffusions
- PbSn plating options
- Package details
- Application notes
- Application and design sample kits
- Custom product and package development

REQUESTING PRODUCT PLATING

1. If requesting Tin/Lead plated devices, add the suffix " TIN/LEAD" to the part number when ordering (example: 2N2222A TIN/LEAD).
2. If requesting Lead (Pb) Free plated devices, add the suffix " PBFREE" to the part number when ordering (example: 2N2222A PBFREE).

CONTACT US

Corporate Headquarters & Customer Support Team

Central Semiconductor Corp.
145 Adams Avenue
Hauppauge, NY 11788 USA
Main Tel: (631) 435-1110
Main Fax: (631) 435-1824
Support Team Fax: (631) 435-3388
www.centrasemi.com

Worldwide Field Representatives:
www.centrasemi.com/wwreps

Worldwide Distributors:
www.centrasemi.com/wwdistributors

For the latest version of Central Semiconductor's **LIMITATIONS AND DAMAGES DISCLAIMER**, which is part of Central's Standard Terms and Conditions of sale, visit: www.centrasemi.com/terms