

CSHDD16-40C CSHDD16-100C  
CSHDD16-60C CSHDD16-200C

**SURFACE MOUNT SILICON  
DUAL, COMMON CATHODE  
SCHOTTKY RECTIFIERS  
16 AMP, 40 THRU 200 VOLT**



www.centrasemi.com

**D<sup>2</sup>PAK!**  
SUPER POWER



**D<sup>2</sup>PAK CASE**

**DESCRIPTION:**

The CENTRAL SEMICONDUCTOR CSHDD16-40C series devices are silicon Schottky rectifiers designed for surface mount applications requiring a low forward voltage drop.

**MARKING:**

**CSHDD16-40C: CSHDD16-40C or CSHDD16-40**  
**CSHDD16-60C: CSHDD16-60C or CSHDD16-60**  
**CSHDD16-100C: CSHDD16-100C or CSHDD16-100**  
**CSHDD16-200C: CSHDD16-200C or CSHDD16-200**

**FEATURES:**

- High reliability
- Low forward voltage
- High current capability
- High surge capacity
- UL flammability classification 94V-O
- Superior lot to lot consistency
- Low power loss, high efficiency
- High voltage

**MAXIMUM RATINGS:** (T<sub>A</sub>=25°C unless otherwise noted)

|  | SYMBOL                            | CSHDD16 |             |       |       | UNITS |
|--|-----------------------------------|---------|-------------|-------|-------|-------|
|  |                                   | -40C    | -60C        | -100C | -200C |       |
| Peak Repetitive Reverse Voltage                | V <sub>RRM</sub>                  | 40      | 60          | 100   | 200   | V     |
| DC Blocking Voltage                            | V <sub>R</sub>                    | 40      | 60          | 100   | 200   | V     |
| RMS Reverse Voltage                            | V <sub>R(RMS)</sub>               | 28      | 42          | 70    | 140   | V     |
| Average Forward Current (T <sub>L</sub> =75°C) | I <sub>O</sub>                    |         | 16          |       |       | A     |
| Peak Forward Surge Current, tp=8.3ms           | I <sub>FSM</sub>                  |         | 150         |       |       | A     |
| Operating and Storage Junction Temperature     | T <sub>J</sub> , T <sub>stg</sub> |         | -65 to +175 |       |       | °C    |
| Typical Thermal Resistance                     | θ <sub>JL</sub>                   |         | 2.0         |       |       | °C/W  |
| Typical Thermal Resistance                     | θ <sub>JA</sub>                   |         | 50          |       |       | °C/W  |

**ELECTRICAL CHARACTERISTICS PER DIODE:** (T<sub>A</sub>=25°C unless otherwise noted)

| SYMBOL         | TEST CONDITIONS  | CSHDD16 |      |      |      |       |      |       |     | UNITS |
|----------------|--|---------|------|------|------|-------|------|-------|-----|-------|
|                |  | -40C    |      | -60C |      | -100C |      | -200C |     |       |
|                |  | TYP     | MAX  | TYP  | MAX  | TYP   | MAX  | TYP   | MAX |       |
| I <sub>R</sub> | V <sub>R</sub> =Rated V <sub>RRM</sub>                         | -       | 50   | -    | 50   | -     | 50   | -     | 50  | µA    |
| I <sub>R</sub> | V <sub>R</sub> =Rated V <sub>RRM</sub> , T <sub>J</sub> =100°C | -       | 20   | -    | 20   | -     | 20   | -     | 20  | mA    |
| V <sub>F</sub> | I <sub>F</sub> =8.0A   | 0.49    | 0.7  | 0.58 | 0.75 | 0.75  | 0.8  | 0.83  | 0.9 | V     |
| V <sub>F</sub> | I <sub>F</sub> =16A  | 0.6     | 0.84 | 0.75 | 0.95 | 0.83  | 1.10 | 0.91  | 1.2 | V     |
| C <sub>J</sub> | V <sub>R</sub> =4.0V, f=1.0MHz                                 | 379     | -    | 280  | -    | 353   | -    | 166   | -   | pF    |

CSHDD16-40C CSHDD16-100C  
 CSHDD16-60C CSHDD16-200C



**SURFACE MOUNT SILICON  
 DUAL, COMMON CATHODE  
 SCHOTTKY RECTIFIERS  
 16 AMP, 40 THRU 200 VOLT**

**D<sup>2</sup>PAK CASE - MECHANICAL OUTLINE**

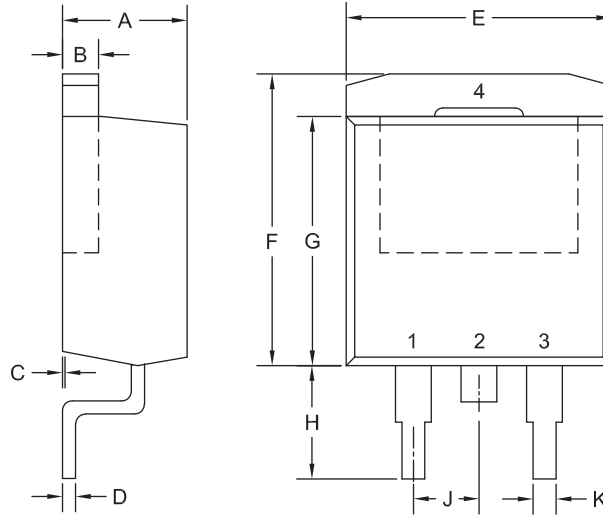

R3

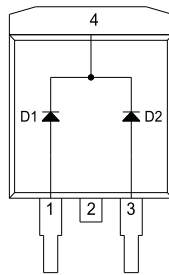

**LEAD CODE:**  
 1) Anode D1  
 2) Cathode D1, D2  
 3) Anode D2  
 4) Cathode D1, D2  
 Pin 2 is Common to the Ta

| SYMBOL | DIMENSIONS |       |             |       |
|--------|------------|-------|-------------|-------|
|        | INCHES     |       | MILLIMETERS |       |
|        | MIN        | MAX   | MIN         | MAX   |
| A      | 0.163      | 0.189 | 4.14        | 4.80  |
| B      | 0.045      | 0.055 | 1.14        | 1.40  |
| C      | 0.000      | 0.010 | 0.00        | 0.25  |
| D      | 0.012      | 0.028 | 0.30        | 0.70  |
| E      | 0.386      | 0.415 | 9.80        | 10.55 |
| F      | 0.378      | 0.417 | 9.60        | 10.60 |
| G      | 0.335      | 0.358 | 8.50        | 9.10  |
| H      | 0.188      | 0.236 | 4.78        | 6.00  |
| J      | 0.093      | 0.108 | 2.35        | 2.75  |
| K      | 0.030      | 0.035 | 0.75        | 0.90  |

D2PAK (REV: R3)

R9 (11-January 2018)

CSHDD16-40C CSHDD16-100C  
 CSHDD16-60C CSHDD16-200C



SURFACE MOUNT SILICON  
 DUAL, COMMON CATHODE  
 SCHOTTKY RECTIFIERS  
 16 AMP, 40 THRU 200 VOLT

TYPICAL ELECTRICAL CHARACTERISTICS

Leakage Current for CSHDD16-40C

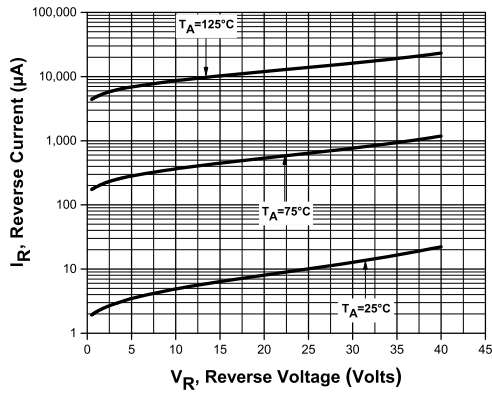

Leakage Current for CSHDD16-60C

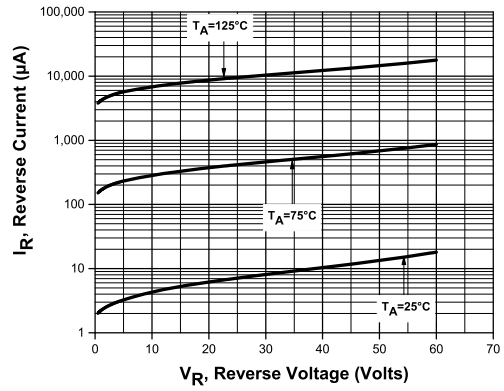

Leakage Current for CSHDD16-100C

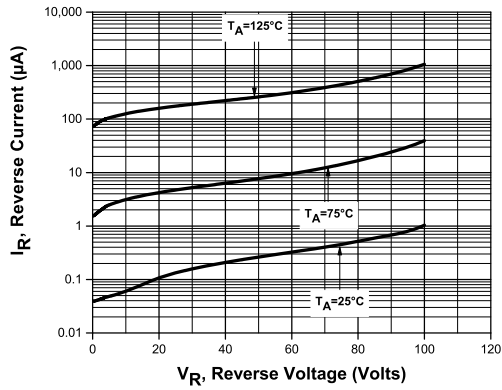

Leakage Current for CSHDD16-200C

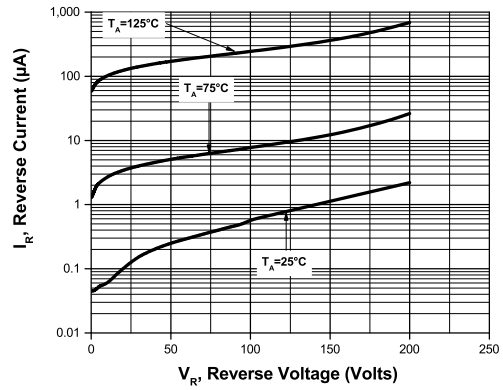

R9 (11-January 2018)

CSHDD16-40C CSHDD16-100C  
 CSHDD16-60C CSHDD16-200C



SURFACE MOUNT SILICON  
 DUAL, COMMON CATHODE  
 SCHOTTKY RECTIFIERS  
 16 AMP, 40 THRU 200 VOLT

TYPICAL ELECTRICAL CHARACTERISTICS

Forward Voltage for CSHDD16-40C per diode

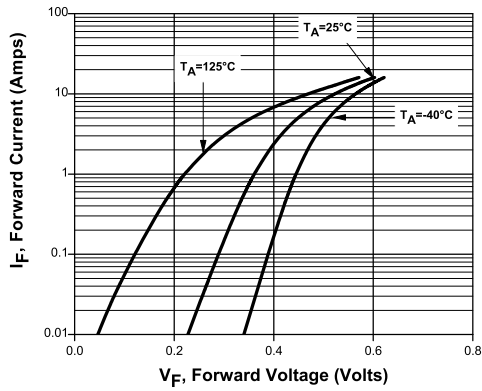

Forward Voltage for CSHDD16-40C, two diodes in parallel

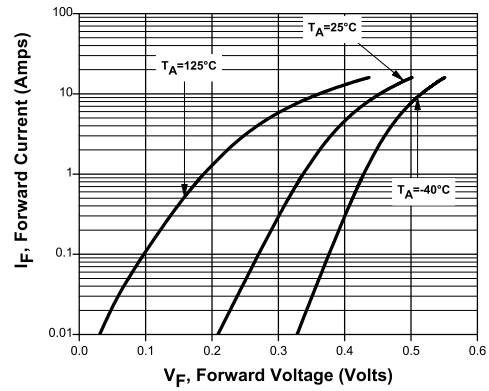

Forward Voltage for CSHDD16-60C per diode

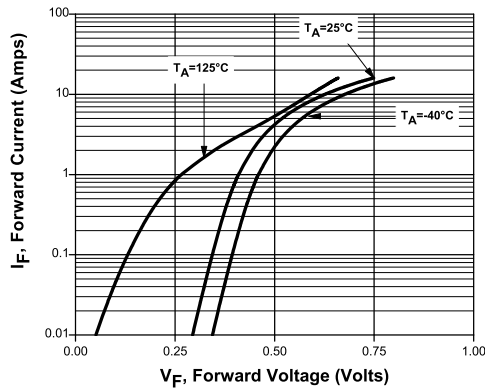

Forward Voltage for CSHDD16-60C, two diodes in parallel

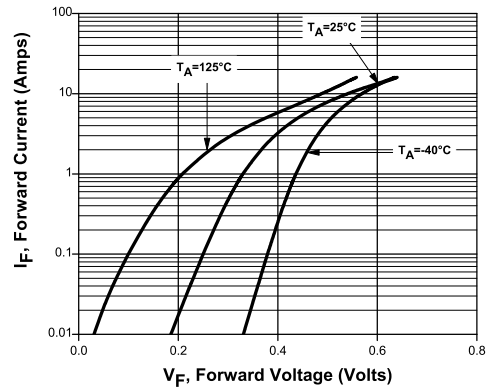

R9 (11-January 2018)

CSHDD16-40C CSHDD16-100C  
 CSHDD16-60C CSHDD16-200C



SURFACE MOUNT SILICON  
 DUAL, COMMON CATHODE  
 SCHOTTKY RECTIFIERS  
 16 AMP, 40 THRU 200 VOLT

TYPICAL ELECTRICAL CHARACTERISTICS

Forward Voltage for CSHDD16-100C per diode

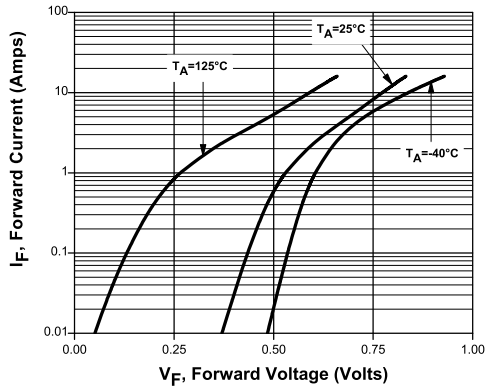

Forward Voltage for CSHDD16-100C, two diodes in parallel

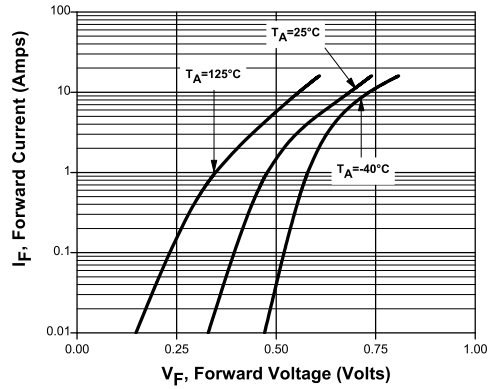

Forward Voltage for CSHDD16-200C per diode

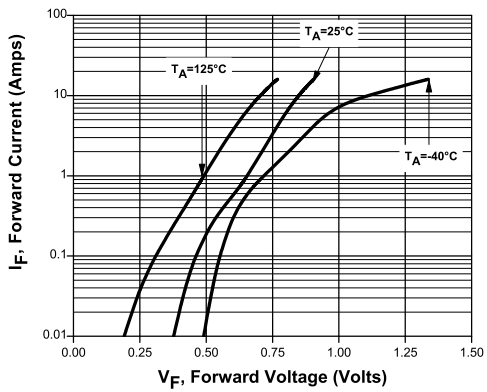

Forward Voltage for CSHDD16-200C, two diodes in parallel

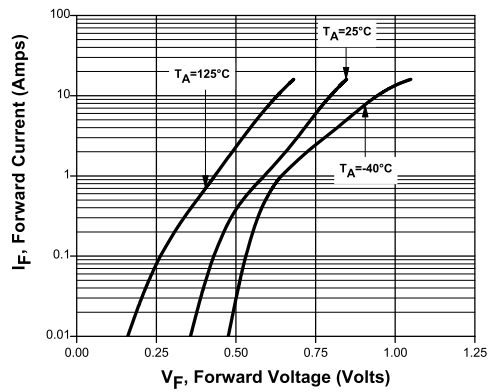

R9 (11-January 2018)

CSHDD16-40C CSHDD16-100C  
 CSHDD16-60C CSHDD16-200C



SURFACE MOUNT SILICON  
 DUAL, COMMON CATHODE  
 SCHOTTKY RECTIFIERS  
 16 AMP, 40 THRU 200 VOLT

TYPICAL ELECTRICAL CHARACTERISTICS

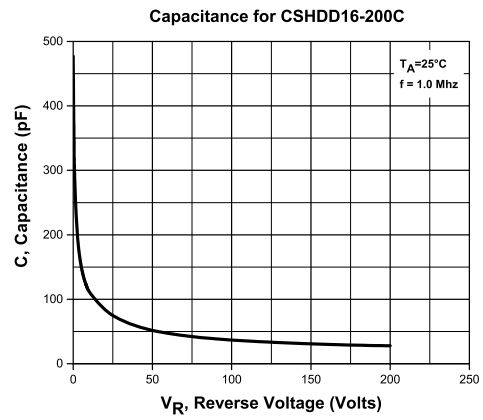
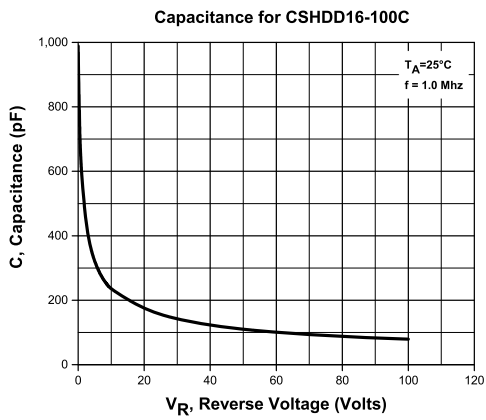
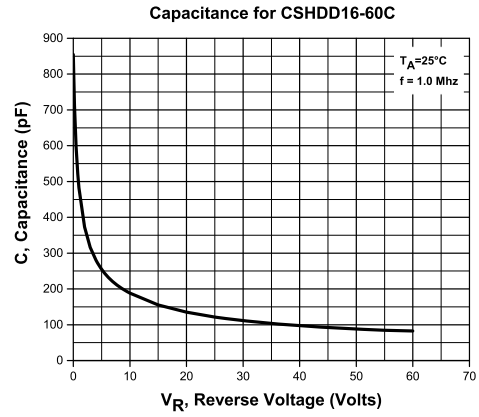
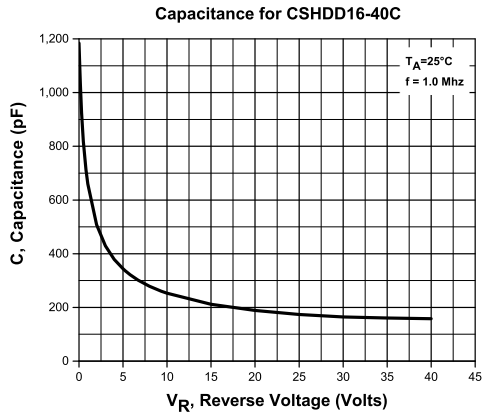

R9 (11-January 2018)

CSHDD16-40C CSHDD16-100C  
CSHDD16-60C CSHDD16-200C

SURFACE MOUNT SILICON  
DUAL, COMMON CATHODE  
SCHOTTKY RECTIFIERS  
16 AMP, 40 THRU 200 VOLT



### TYPICAL ELECTRICAL CHARACTERISTICS

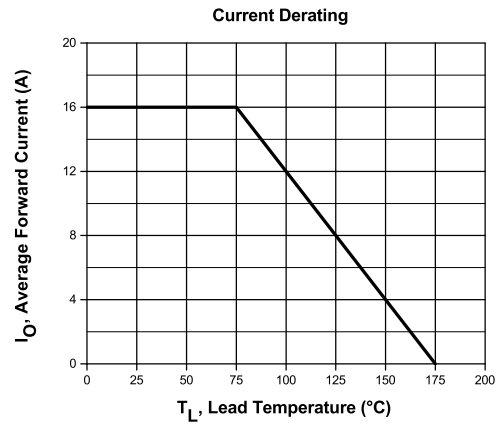

R9 (11-January 2018)

## OUTSTANDING SUPPORT AND SUPERIOR SERVICES



---

### PRODUCT SUPPORT

Central's operations team provides the highest level of support to insure product is delivered on-time.

- Supply management (Customer portals)
- Inventory bonding
- Consolidated shipping options
- Custom bar coding for shipments
- Custom product packing

---

### DESIGNER SUPPORT/SERVICES

Central's applications engineering team is ready to discuss your design challenges. Just ask.

- Free quick ship samples (2<sup>nd</sup> day air)
- Online technical data and parametric search
- SPICE models
- Custom electrical curves
- Environmental regulation compliance
- Customer specific screening
- Up-screening capabilities
- Special wafer diffusions
- PbSn plating options
- Package details
- Application notes
- Application and design sample kits
- Custom product and package development

---

### REQUESTING PRODUCT PLATING

1. If requesting Tin/Lead plated devices, add the suffix " TIN/LEAD" to the part number when ordering (example: 2N2222A TIN/LEAD).
2. If requesting Lead (Pb) Free plated devices, add the suffix " PBFREE" to the part number when ordering (example: 2N2222A PBFREE).

---

### CONTACT US

#### Corporate Headquarters & Customer Support Team

Central Semiconductor Corp.  
145 Adams Avenue  
Hauppauge, NY 11788 USA  
Main Tel: (631) 435-1110  
Main Fax: (631) 435-1824  
Support Team Fax: (631) 435-3388  
[www.centrasemi.com](http://www.centrasemi.com)

**Worldwide Field Representatives:**  
[www.centrasemi.com/wwreps](http://www.centrasemi.com/wwreps)

**Worldwide Distributors:**  
[www.centrasemi.com/wwdistributors](http://www.centrasemi.com/wwdistributors)

---

For the latest version of Central Semiconductor's **LIMITATIONS AND DAMAGES DISCLAIMER**, which is part of Central's Standard Terms and Conditions of sale, visit: [www.centrasemi.com/terms](http://www.centrasemi.com/terms)