

### FEATURES

#### DOCSIS 3.0 performance: 4 QAM carriers

##### ACLR over full band (47 MHz to 1 GHz)

- 75 dBc @  $f_{OUT} = 200$  MHz
- 72 dBc @  $f_{OUT} = 800$  MHz (noise)
- 67 dBc @  $f_{OUT} = 800$  MHz (harmonics)

##### Unequalized MER = 42 dB

#### On chip and bypassable

##### 4 QAM encoders with SRRC filters, 16x to 512x interpolation, rate converters, and modulators

#### Flexible data interface: 4, 8, 16, or 32 bits wide with parity

#### Power: 1.6 W ( $I_{FS} = 20$ mA, $f_{DAC} = 2.4$ GHz, LVDS interface)

#### Direct to RF synthesis support with $f_s$ mix mode

#### Built-in self-test (BIST) support

- Input connectivity check
- Internal random number generator

### APPLICATIONS

#### Broadband communications systems

#### CMTS/DVB

#### Cellular infrastructure

#### Point-to-point wireless

### GENERAL DESCRIPTION

The AD9789 is a flexible QAM encoder/interpolator/upconverter combined with a high performance, 2400 MSPS, 14-bit RF digital-to-analog converter (DAC). The flexible digital interface can accept up to four channels of complex data. The QAM encoder supports constellation sizes of 16, 32, 64, 128, and 256 with SRRC filter coefficients for all standards.

The on-chip rate converter supports a wide range of baud rates with a fixed DAC clock. The digital upconverter can place the channels from 0 to  $0.5 \times f_{DAC}$ . This permits four contiguous channels to be synthesized and placed anywhere from dc to  $f_{DAC}/2$ .

The AD9789 includes a serial peripheral interface (SPI) for device configuration and status register readback. The flexible digital interface can be configured for data bus widths of 4, 8, 16, and 32 bits. It can accept real or complex data.

The AD9789 operates from 1.5 V, 1.8 V, and 3.3 V supplies for a total power consumption of 1.6 W. It is supplied in a 164-ball chip scale package ball grid array for lower thermal impedance and reduced package parasitics. No special power sequencing is required. The clock receiver powers up muted to prevent start-up noise.

### PRODUCT HIGHLIGHTS

1. Highly integrated and configurable QAM mappers, interpolators, and upconverters for direct synthesis of one to four DOCSIS- or DVB-C-compatible channels in a block.
2. Low noise and intermodulation distortion (IMD) performance enable high quality synthesis of signals up to 1 GHz.
3. Flexible data interface supports LVDS for improved SFDR or CMOS input data for less demanding applications.
4. Interface is configurable from 4-bit nibbles to 32-bit words and can run at up to 150 MHz CMOS or 150 MHz LVDS double data rate (DDR).
5. Manufactured on a CMOS process, the AD9789 uses a proprietary switching technique that enhances dynamic performance.

### FUNCTIONAL BLOCK DIAGRAM

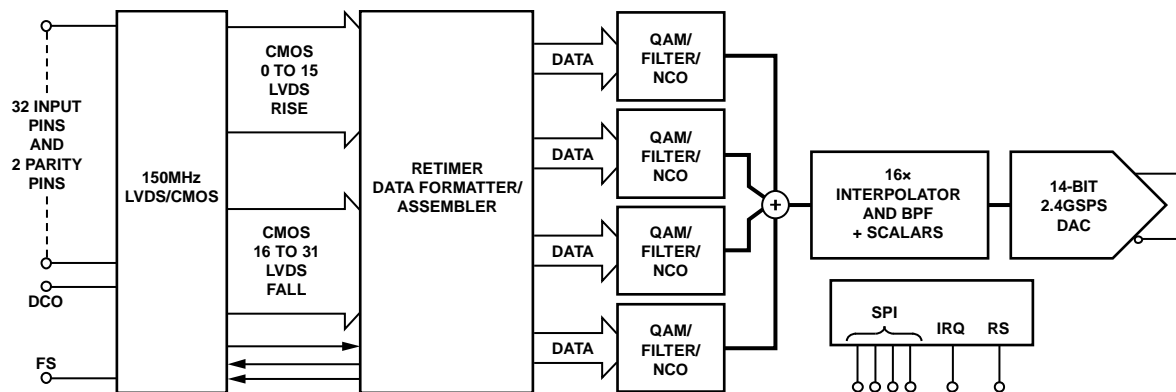

Figure 1.

07952-001

#### Rev. A

Information furnished by Analog Devices is believed to be accurate and reliable. However, no responsibility is assumed by Analog Devices for its use, nor for any infringements of patents or other rights of third parties that may result from its use. Specifications subject to change without notice. No license is granted by implication or otherwise under any patent or patent rights of Analog Devices. Trademarks and registered trademarks are the property of their respective owners.

# AD9789\* PRODUCT PAGE QUICK LINKS

Last Content Update: 02/23/2017

---

## COMPARABLE PARTS

View a parametric search of comparable parts.

## EVALUATION KITS

- AD9789 Evaluation Board

## DOCUMENTATION

### Data Sheet

- AD9789: 14-Bit, 2400 MSPS RF DAC with 4-Channel Signal Processing Data Sheet

## SOFTWARE AND SYSTEMS REQUIREMENTS

- AD9789 Evaluation Board, DAC-FMC Interposer & Xilinx ML605 Reference Design

## TOOLS AND SIMULATIONS

- AD9789 IBIS Model

## REFERENCE MATERIALS

### Informational

- Advantiv™ Advanced TV Solutions

### Solutions Bulletins & Brochures

- Digital to Analog Converters ICs Solutions Bulletin
- Digital-to-Analog Converter ICs Solutions Bulletin, Volume 10, Issue 1

## DESIGN RESOURCES

- AD9789 Material Declaration
- PCN-PDN Information
- Quality And Reliability
- Symbols and Footprints

## DISCUSSIONS

View all AD9789 EngineerZone Discussions.

## SAMPLE AND BUY

Visit the product page to see pricing options.

## TECHNICAL SUPPORT

Submit a technical question or find your regional support number.

## DOCUMENT FEEDBACK

Submit feedback for this data sheet.

## TABLE OF CONTENTS

|  |    |   |    |
|--|----|---|----|
| Features .....                                     | 1  | SPI Register Descriptions.....  | 29 |
| Applications.....                                  | 1  | Theory of Operation .....   | 39 |
| General Description .....                          | 1  | Datapath Signal Processing.....   | 39 |
| Product Highlights .....                           | 1  | Digital Block Upconverter .....   | 43 |
| Functional Block Diagram .....                     | 1  | Digital Interface Modes .....   | 45 |
| Revision History .....                             | 2  | Analog Modes of Operation .....   | 54 |
| Detailed Functional Block Diagrams.....            | 3  | Analog Control Registers .....  | 55 |
| Specifications.....                                | 4  | Voltage Reference .....   | 56 |
| DC Specifications .....                            | 4  | DAC Output Stages.....  | 56 |
| Digital Specifications .....                       | 5  | Clocking the AD9789 .....   | 57 |
| AC Specifications.....                             | 6  | Mu Delay Controller .....   | 58 |
| Absolute Maximum Ratings.....                      | 8  | Interrupt Requests.....   | 61 |
| Thermal Resistance .....                           | 8  | Recommended Start-Up Sequence .....   | 62 |
| ESD Caution.....                                   | 8  | Customer BIST Modes.....  | 63 |
| Pin Configurations and Function Descriptions ..... | 9  | Using the Internal PRN Generator to Test QAM Output AC Performance .....                      | 63 |
| Typical Performance Characteristics .....          | 12 | Using the Internal Built-In Self-Test (BIST) to Test for Digital Data Input Connectivity..... | 63 |
| Terminology .....                                  | 22 | QAM Constellation Maps .....  | 65 |
| Serial Control Port.....                           | 23 | Channelizer Mode Pin Mapping for CMOS and LVDS.....   | 68 |
| Serial Control Port Pin Descriptions.....          | 23 | Outline Dimensions .....  | 74 |
| General Operation of Serial Control Port.....      | 23 | Ordering Guide .....  | 74 |
| Instruction Word (16 Bits) .....                   | 24 |   |    |
| MSB/LSB First Transfers.....                       | 24 |   |    |
| SPI Register Map.....                              | 27 |   |    |

## REVISION HISTORY

### 7/11—Rev. 0 to Rev. A

|   |    |
|---|----|
| Changes to Table 2, DAC Clock Input (CLKP, CLKN): Added DAC Clock Rate Parameter.....                             | 5  |
| Changes to Table 3, Dynamic Performance, DAC Update Rate Parameter; Added Adjusted DAC Update Rate Parameter..... | 6  |
| Changes to Captions for Figure 42, Figure 44, Figure 46, Figure 49 .....  | 18 |
| Changes to Digital 16x Tunable Band-Pass Filter Section, Third Paragraph.....                                     | 44 |
| Changes to Retimer and Latency Look-Up Tables Section, Second Paragraph .....                                     | 50 |
| Changes to Captions for Figure 122, Figure 124, Figure 125....  | 65 |

### 4/09—Revision 0: Initial Version

# DETAILED FUNCTIONAL BLOCK DIAGRAMS

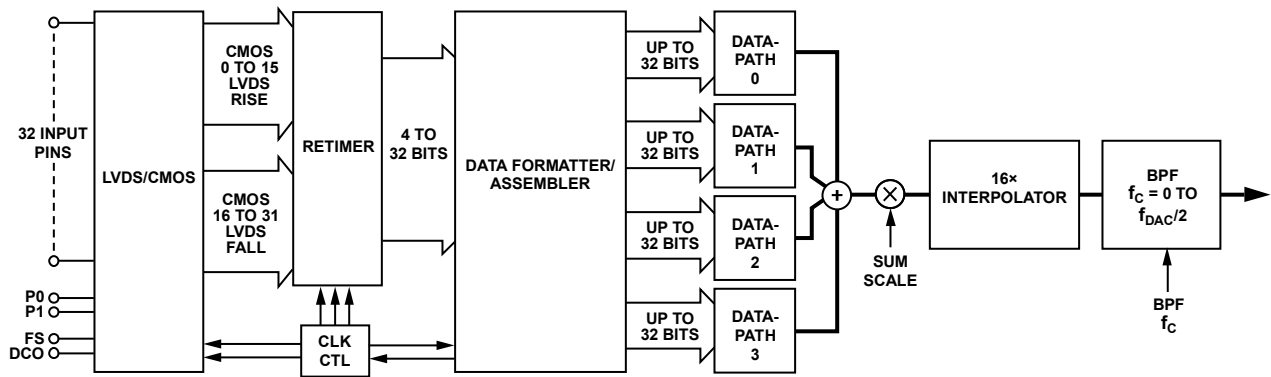

Figure 2. Digital Signal Processing Functional Block Diagram

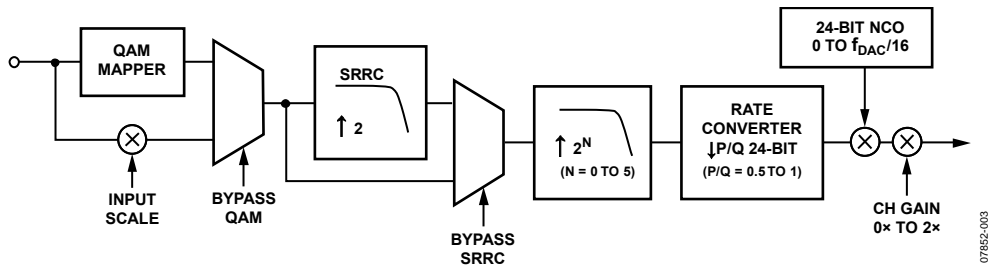

Figure 3. Channel 0 Through Channel 3 Datapath Block Detail (I and Q Paths Are Identical So Only One Is Shown)

## SPECIFICATIONS

### DC SPECIFICATIONS

AVDD33 = DVDD33 = 3.3 V, CVDD18 = DVDD18 = 1.8 V, DVDD15 = 1.5 V,  $f_{DAC} = 2.4$  GHz,  $I_{FS} = 20$  mA, unless otherwise noted.

Table 1.

| Parameter  | Min  | Typ   | Max   | Unit              |
|--|------|-------|-------|-------------------|
| DAC RESOLUTION   |      | 14    |       | Bits              |
| ANALOG OUTPUTS   |      |       |       |                   |
| Offset Error   |      | 6.5   |       | % FSR             |
| Gain Error (with Internal Reference)   |      | 3.5   |       | % FSR             |
| Full-Scale Output Current (Monotonicity Guaranteed)                                | 8.66 | 20.2  | 31.66 | mA                |
| Output Compliance Range  | -1.0 |       | +1.0  | V                 |
| Output Resistance  |      | 70    |       | $\Omega$          |
| Output Capacitance   |      | 1     |       | pF                |
| TEMPERATURE DRIFT  |      |       |       |                   |
| Gain   |      | 135   |       | ppm/ $^{\circ}$ C |
| Reference Voltage  |      | 25    |       | ppm/ $^{\circ}$ C |
| REFERENCE  |      |       |       |                   |
| Internal Reference Voltage   |      | 1.2   |       | V                 |
| Output Resistance <sup>1</sup>   |      | 5     |       | k $\Omega$        |
| ANALOG SUPPLY VOLTAGES   |      |       |       |                   |
| AVDD33   | 3.14 | 3.3   | 3.47  | V                 |
| CVDD18   | 1.71 | 1.8   | 1.89  | V                 |
| DIGITAL SUPPLY VOLTAGES  |      |       |       |                   |
| DVDD33   | 3.14 | 3.3   | 3.47  | V                 |
| DVDD18   | 1.71 | 1.8   | 1.89  | V                 |
| DVDD15   | 1.43 | 1.5   | 1.58  | V                 |
| SUPPLY CURRENTS AND POWER DISSIPATION  |      |       |       |                   |
| $f_{DAC} = 2.4$ GSPS, $f_{OUT} = 930$ MHz, $I_{FS} = 25$ mA, Four Channels Enabled |      |       |       |                   |
| $I_{AVDD33}$   |      | 45    |       | mA                |
| $I_{DVDD18}$   |      | 72    |       | mA                |
| $I_{CVDD18}$   |      | 180   |       | mA                |
| $I_{DVDD33}$   |      |       |       |                   |
| CMOS Interface   |      | 42    |       | mA                |
| LVDS Interface   |      | 16    |       | mA                |
| $I_{DVDD15}$   |      | 640   |       | mA                |
| $f_{DAC} = 2.0$ GSPS, $f_{OUT} = 70$ MHz, $I_{FS} = 20$ mA, CMOS Interface         |      |       |       |                   |
| $I_{AVDD33}$   |      | 37.4  | 38.5  | mA                |
| $I_{DVDD18}$   |      | 67.3  | 70.5  | mA                |
| $I_{CVDD18}$   |      | 155.4 | 180   | mA                |
| $I_{DVDD33}$   |      | 40.3  | 50.7  | mA                |
| $I_{DVDD15}$ (Four Channels Enabled, All Signal Processing Enabled)                |      | 517   | 556   | mA                |
| $I_{DVDD15}$ (One Channel Enabled, 16 $\times$ Interpolation Only)                 |      | 365   | 391   | mA                |
| Power Dissipation  |      |       |       |                   |
| $f_{DAC} = 2.4$ GSPS, $f_{OUT} = 930$ MHz, $I_{FS} = 25$ mA, Four Channels Enabled |      |       |       |                   |
| CMOS Interface   |      | 1.7   |       | W                 |
| LVDS Interface   |      | 1.63  |       | W                 |

<sup>1</sup> Use an external amplifier to drive any external load.

**DIGITAL SPECIFICATIONS**

AVDD33 = DVDD33 = 3.3 V, CVDD18 = DVDD18 = 1.8 V, DVDD15 = 1.5 V,  $f_{DAC} = 2.4$  GHz,  $I_{FS} = 20$  mA, LVDS drivers and receivers are compliant with the IEEE Std 1596.3-1996 reduced range link, unless otherwise noted.

**Table 2.**

| Parameter  | Min  | Typ | Max  | Unit     |
|--|------|-----|------|----------|
| <b>CMOS DATA INPUTS (D[31:0], P0, P1)</b>                                  |      |     |      |          |
| Input Voltage High, $V_{IH}$   | 2.0  | 3.3 |      | V        |
| Input Voltage Low, $V_{IL}$  |      | 0   | 0.8  | V        |
| Input Current High, $I_{IH}$   | -10  |     | +10  | $\mu$ A  |
| Input Current Low, $I_{IL}$  | -10  |     | +10  | $\mu$ A  |
| Input Capacitance  |      | 2   |      | pF       |
| Setup Time, CMOS Data Input to CMOS_DCO <sup>1</sup>                       | 5.3  |     |      | ns       |
| Hold Time, CMOS Data Input to CMOS_DCO <sup>1</sup>                        | -1.4 |     |      | ns       |
| <b>CMOS OUTPUTS (CMOS_FS, CMOS_DCO)</b>                                    |      |     |      |          |
| Output Voltage High, $V_{OH}$  | 2.4  |     | 3.3  | V        |
| Output Voltage Low, $V_{OL}$   | 0    |     | 0.4  | V        |
| Output Current High, $I_{OH}$  |      | 12  |      | mA       |
| Output Current Low, $I_{OL}$   |      | 12  |      | mA       |
| Maximum Clock Rate (CMOS_DCO)  | 150  |     |      | MHz      |
| CMOS_DCO to CMOS_FS Delay  | 0.28 |     | 0.85 | ns       |
| <b>LVDS DATA INPUTS (D[15:0]P, D[15:0]N, PARP, PARN)</b>                   |      |     |      |          |
| Input Voltage Range, $V_{IA}$ or $V_{IB}$                                  | 825  |     | 1575 | mV       |
| Input Differential Threshold, $V_{IDTH}$                                   | -100 |     | +100 | mV       |
| Input Differential Hysteresis, $V_{IDTHH}$ , $V_{IDTHL}$                   |      | 25  |      | mV       |
| Input Differential Input Impedance, $R_{IN}$                               | 80   |     | 120  | $\Omega$ |
| Maximum LVDS Input Rate  | 150  |     |      | MSPS     |
| Setup Time, LVDS Differential Input Data to Differential DCOx <sup>2</sup> | 1.41 |     |      | ns       |
| Hold Time, LVDS Differential Input Data to Differential DCOx <sup>2</sup>  | 0.24 |     |      | ns       |
| <b>LVDS OUTPUTS (DCOP, DCON, FSP, FSN)</b>                                 |      |     |      |          |
| DCOP, FSP = $V_{OA}$ ; DCON, FSN = $V_{OB}$ ; 100 $\Omega$ Termination     |      |     |      |          |
| Output Voltage High, $V_{OA}$ or $V_{OB}$                                  |      |     | 1375 | mV       |
| Output Voltage Low, $V_{OA}$ or $V_{OB}$                                   | 1025 |     |      | mV       |
| Output Differential Voltage, $ V_{OD} $                                    | 150  | 200 | 250  | mV       |
| Output Offset Voltage, $V_{OS}$  | 1150 |     | 1250 | mV       |
| Output Impedance, Single Ended, $R_o$                                      | 40   |     | 140  | $\Omega$ |
| $R_o$ Mismatch Between A and B, $\Delta R_o$                               |      |     | 10   | %        |
| Change in $ V_{OD} $ Between 0 and 1, $ \Delta V_{OD} $                    |      |     | 25   | mV       |
| Change in $V_{OS}$ Between 0 and 1, $\Delta V_{OS}$                        |      |     | 25   | mV       |
| Output Current—Driver Shorted to Ground, $I_{SA}$ , $I_{SB}$               |      |     | 20   | mA       |
| Output Current—Drivers Shorted Together, $I_{SAB}$                         |      |     | 4    | mA       |
| Power-Off Output Leakage, $ I_{XA} $ , $ I_{XB} $                          |      |     | 10   | mA       |
| Maximum Clock Rate (DCOP, DCON)  | 150  |     |      | MHz      |
| DCOx to FSx Delay  | 0.12 |     | 0.37 | ns       |
| <b>DAC CLOCK INPUT (CLKP, CLKN)<sup>3</sup></b>                            |      |     |      |          |
| Differential Peak Voltage  | 1.4  | 1.8 |      | V        |
| Common-Mode Voltage  |      | 900 |      | mV       |
| DAC Clock Rate   |      |     | 2400 | MHz      |
| <b>SERIAL PERIPHERAL INTERFACE</b>   |      |     |      |          |
| Maximum Clock Rate ( $f_{SCLK}$ , $1/t_{SCLK}$ )                           |      |     | 25   | MHz      |
| Minimum Pulse Width High, $t_{PWH}$  | 20   |     |      | ns       |
| Minimum Pulse Width Low, $t_{PWL}$   | 20   |     |      | ns       |
| Minimum SDIO and $\overline{CS}$ to SCLK Setup, $t_{DS}$                   |      | 10  |      | ns       |

# AD9789

| Parameter  | Min | Typ | Max | Unit    |
|--|-----|-----|-----|---------|
| Minimum SCLK to SDIO Hold, $t_{DH}$                    |     | 5   |     | ns      |
| Maximum SCLK to Valid SDIO and SDO, $t_{DV}$           |     | 20  |     | ns      |
| Minimum SCLK to Invalid SDIO and SDO, $t_{DNV}$        |     | 5   |     | ns      |
| <b>INPUTS (SDIO, SCLK, <math>\overline{CS}</math>)</b> |     |     |     |         |
| Input Voltage High, $V_{IH}$                           | 2.0 | 3.3 |     | V       |
| Input Voltage Low, $V_{IL}$                            |     | 0   | 0.8 | V       |
| Input Current High, $I_{IH}$                           | -10 |     | +10 | $\mu$ A |
| Input Current Low, $I_{IL}$                            | -10 |     | +10 | $\mu$ A |
| <b>OUTPUTS (SDO, SDIO)</b>                             |     |     |     |         |
| Output Voltage High, $V_{OH}$                          | 2.4 |     | 3.6 | V       |
| Output Voltage Low, $V_{OL}$                           | 0   |     | 0.4 | V       |
| Output Current High, $I_{OH}$                          |     | 4   |     | mA      |
| Output Current Low, $I_{OL}$                           |     | 4   |     | mA      |

<sup>1</sup> See the CMOS Interface Timing section for more information.

<sup>2</sup> See the LVDS Interface Timing section for more information.

<sup>3</sup> See the Clock Phase Noise Effects on AC Performance section for more information.

## AC SPECIFICATIONS

AVDD33 = DVDD33 = 3.3 V, CVDD18 = DVDD18 = 1.8 V, DVDD15 = 1.5 V,  $f_{DAC} = 2.4$  GHz,  $I_{FS} = 20$  mA, digital scale = 0 dBFS, unless otherwise noted.

Table 3.

| Parameter  | Test Conditions/Comments                       | Min | Typ    | Max  | Unit   |
|--|--|-----|--------|------|--------|
| <b>DYNAMIC PERFORMANCE</b>                       |  |     |        |      |        |
| DAC Update Rate                                  |  |     |        | 2400 | MSPS   |
| Adjusted DAC Update Rate <sup>1</sup>            |  |     |        | 150  | MSPS   |
| Output Settling Time ( $t_{ST}$ )                | To 0.025%                                      |     | 13     |      | ns     |
| <b>SPURIOUS-FREE DYNAMIC RANGE (SFDR)</b>        |  |     |        |      |        |
| $f_{DAC} = 2000$ MSPS                            |  |     |        |      |        |
| $f_{OUT} = 100$ MHz                              |  |     | 70     |      | dBc    |
| $f_{OUT} = 316$ MHz                              |  |     | 63     |      | dBc    |
| $f_{OUT} = 550$ MHz                              |  |     | 58     |      | dBc    |
| $f_{DAC} = 2400$ MSPS                            |  |     |        |      |        |
| $f_{OUT} = 100$ MHz                              |  |     | 70     |      | dBc    |
| $f_{OUT} = 316$ MHz                              |  |     | 70     |      | dBc    |
| $f_{OUT} = 550$ MHz                              |  |     | 60     |      | dBc    |
| $f_{OUT} = 850$ MHz                              |  |     | 60     |      | dBc    |
| <b>TWO-TONE INTERMODULATION DISTORTION (IMD)</b> |  |     |        |      |        |
|  | $f_{OUT2} = f_{OUT1} + 1.25$ MHz               |     |        |      |        |
| $f_{DAC} = 2000$ MSPS                            |  |     |        |      |        |
| $f_{OUT} = 100$ MHz                              |  |     | 86     |      | dBc    |
| $f_{OUT} = 316$ MHz                              |  |     | 73     |      | dBc    |
| $f_{OUT} = 550$ MHz                              |  |     | 62     |      | dBc    |
| $f_{DAC} = 2400$ MSPS                            |  |     |        |      |        |
| $f_{OUT} = 100$ MHz                              |  |     | 86     |      | dBc    |
| $f_{OUT} = 316$ MHz                              |  |     | 74     |      | dBc    |
| $f_{OUT} = 550$ MHz                              |  |     | 66     |      | dBc    |
| $f_{OUT} = 850$ MHz                              |  |     | 66     |      | dBc    |
| <b>NOISE SPECTRAL DENSITY (NSD)</b>              |  |     |        |      |        |
| 1-Channel QAM                                    |  |     |        |      |        |
| $f_{OUT} = 100$ MHz                              | $f_{DAC} = 2400$ MSPS<br>$P_{OUT} = -14.5$ dBm |     | -167   |      | dBm/Hz |
| $f_{OUT} = 316$ MHz                              | $P_{OUT} = -15.5$ dBm                          |     | -166.5 |      | dBm/Hz |
| $f_{OUT} = 550$ MHz                              | $P_{OUT} = -18$ dBm                            |     | -166.5 |      | dBm/Hz |
| $f_{OUT} = 850$ MHz                              | $P_{OUT} = -18.5$ dBm                          |     | -166.5 |      | dBm/Hz |

| Parameter                             | Test Conditions/Comments                            | Min | Typ   | Max | Unit |
|---------------------------------------|---|-----|-------|-----|------|
| ADJACENT CHANNEL LEAKAGE RATIO (ACLR) | $f_{DAC} = 2293.76$ MSPS measured in 6 MHz channels |     |       |     |      |
| 1-Channel QAM                         |   |     |       |     |      |
| $f_{OUT} = 200$ MHz (Harmonics)       |   |     | -76   |     | dBc  |
| $f_{OUT} = 200$ MHz (Noise Floor)     |   |     | -82   |     | dBc  |
| $f_{OUT} = 500$ MHz (Harmonics)       |   |     | -74.5 |     | dBc  |
| $f_{OUT} = 500$ MHz (Noise Floor)     |   |     | -78   |     | dBc  |
| $f_{OUT} = 800$ MHz (Harmonics)       |   |     | -69   |     | dBc  |
| $f_{OUT} = 800$ MHz (Noise Floor)     |   |     | -78   |     | dBc  |
| 2-Channel QAM                         |   |     |       |     |      |
| $f_{OUT} = 200$ MHz (Harmonics)       |   |     | -77.5 |     | dBc  |
| $f_{OUT} = 200$ MHz (Noise Floor)     |   |     | -81   |     | dBc  |
| $f_{OUT} = 500$ MHz (Harmonics)       |   |     | -68   |     | dBc  |
| $f_{OUT} = 500$ MHz (Noise Floor)     |   |     | -76   |     | dBc  |
| $f_{OUT} = 800$ MHz (Harmonics)       |   |     | -66   |     | dBc  |
| $f_{OUT} = 800$ MHz (Noise Floor)     |   |     | -76   |     | dBc  |
| 4-Channel QAM                         |   |     |       |     |      |
| $f_{OUT} = 200$ MHz (Harmonics)       |   |     | -75   |     | dBc  |
| $f_{OUT} = 200$ MHz (Noise Floor)     |   |     | -76   |     | dBc  |
| $f_{OUT} = 500$ MHz (Harmonics)       |   |     | -69   |     | dBc  |
| $f_{OUT} = 500$ MHz (Noise Floor)     |   |     | -72   |     | dBc  |
| $f_{OUT} = 800$ MHz (Harmonics)       |   |     | -67   |     | dBc  |
| $f_{OUT} = 800$ MHz (Noise Floor)     |   |     | -72   |     | dBc  |
| WCDMA ACLR                            | $f_{DAC} = 2304$ MSPS, mix mode second Nyquist zone |     |       |     |      |
| Single Carrier                        | $f_{OUT} = 1850$ MHz                                |     |       |     |      |
| First Adjacent Channel                |   |     | -70   |     | dBc  |
| Second Alternate Channel              |   |     | -72.5 |     | dBc  |
| Third Alternate Channel               |   |     | -74   |     | dBc  |
| Single Carrier                        | $f_{OUT} = 2100$ MHz                                |     |       |     |      |
| First Adjacent Channel                |   |     | -68   |     | dBc  |
| Second Alternate Channel              |   |     | -70.4 |     | dBc  |
| Third Alternate Channel               |   |     | -72.7 |     | dBc  |
| Four Carrier                          | $f_{OUT} = 2100$ MHz                                |     |       |     |      |
| First Adjacent Channel                |   |     | -63.5 |     | dBc  |
| Second Alternate Channel              |   |     | -65.1 |     | dBc  |
| Third Alternate Channel               |   |     | -66.9 |     | dBc  |

<sup>1</sup> Adjusted DAC update rate is calculated as  $f_{DAC}$  divided by the minimum required interpolation factor. For the AD9789, the minimum interpolation factor is 16. Thus, with  $f_{DAC} = 2400$  MSPS,  $F_{DACadj} = 2400 \text{ MSPS}/16 = 150 \text{ MSPS}$ .



## ABSOLUTE MAXIMUM RATINGS

Table 4.

| Parameter  | Rating                   |
|--|--------------------------|
| AVDD33 to AVSS   | −0.3 V to +3.6 V         |
| DVDD18 to DVSS   | −0.3 V to +1.98 V        |
| DVDD33 to DVSS   | −0.3 V to +3.6 V         |
| DVDD15 to DVSS   | −0.3 V to +1.98 V        |
| CVDD18 to AVSS   | −0.3 V to +1.98 V        |
| AVSS to DVSS   | −0.3 V to +0.3 V         |
| CLKP, CLKN to AVSS   | −0.3 V to CVDD18 + 0.3 V |
| FS, DCO to DVSS  | −0.3 V to DVDD33 + 0.3 V |
| CMOS and LVDS Data Inputs to DVSS                            | −0.3 V to DVDD33 + 0.3 V |
| IOUTN, IOUTP to AVSS   | −1.0 V to AVDD33 + 0.3 V |
| I120, VREF, IPTAT to AVSS                                    | −0.3 V to AVDD33 + 0.3 V |
| IRQ, $\overline{\text{CS}}$ , SCLK, SDO, SDIO, RESET to DVSS | −0.3 V to DVDD33 + 0.3 V |
| Junction Temperature   | 150°C                    |
| Storage Temperature Range                                    | −65°C to +150°C          |

Stresses above those listed under Absolute Maximum Ratings may cause permanent damage to the device. This is a stress rating only; functional operation of the device at these or any other conditions above those indicated in the operational section of this specification is not implied. Exposure to absolute maximum rating conditions for extended periods may affect device reliability.

## THERMAL RESISTANCE

$\theta_{JA}$  is specified for the worst-case conditions, that is, a device soldered in a circuit board for surface-mount packages.

Table 5. Thermal Resistance

| Package Type     | $\theta_{JA}$ | $\theta_{JB}$ | $\theta_{JC}$ | Unit | Notes                      |
|------------------|---------------|---------------|---------------|------|----------------------------|
| 164-Ball CSP_BGA | 25.5          | 14.4          | 6.8           | °C/W | 4-layer board, no vias     |
|                  | 24.4          |               |               | °C/W | 4-layer board, 4 PCB vias  |
|                  | 19.0          |               |               | °C/W | 8-layer board, 4 PCB vias  |
|                  | 17.2          |               |               | °C/W | 8-layer board, 16 PCB vias |

## ESD CAUTION



**ESD (electrostatic discharge) sensitive device.** Charged devices and circuit boards can discharge without detection. Although this product features patented or proprietary protection circuitry, damage may occur on devices subjected to high energy ESD. Therefore, proper ESD precautions should be taken to avoid performance degradation or loss of functionality.

# PIN CONFIGURATIONS AND FUNCTION DESCRIPTIONS

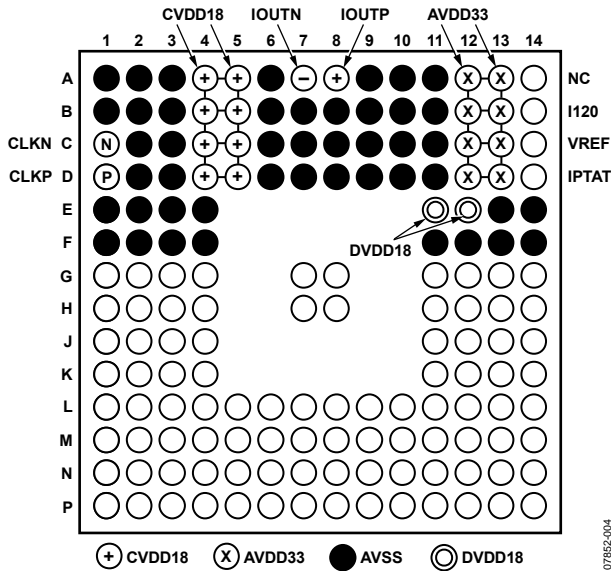

Figure 4. Clock and Analog Pins (Top View)

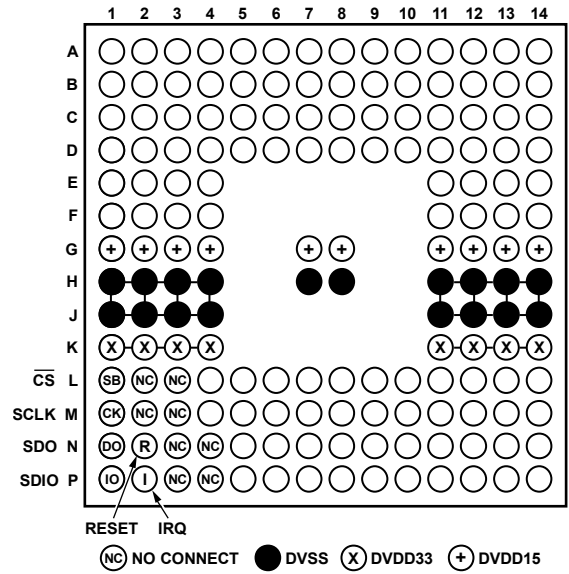

Figure 6. Digital Supply and SPI Pins (Top View)

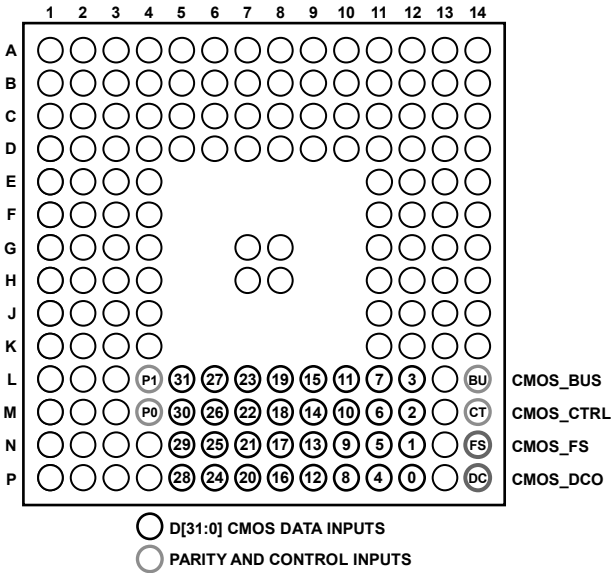

Figure 5. CMOS Mode Data Input Pins (Top View)

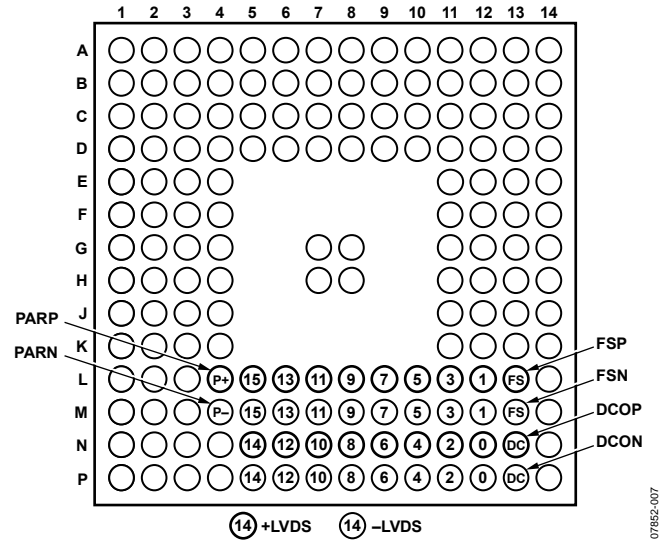

Figure 7. LVDS Mode Data Input Pins (Top View)

**Table 6. Pin Function Descriptions**

| Pin No.  | Mnemonic        | Description  |
|--|-----------------|--|
| A1, A2, A3, A6, A9, A10, A11, B1, B2, B3, B6, B7, B8, B9, B10, B11, C2, C3, C6, C7, C8, C9, C10, C11, D2, D3, D6, D7, D8, D9, D10, D11, E1, E2, E3, E4, E13, E14, F1, F2, F3, F4, F11, F12, F13, F14 | AVSS            | Analog Supply Ground.  |
| A4, A5, B4, B5, C4, C5, D4, D5   | CVDD18          | 1.8 V Clock Supply.  |
| A7   | IOUTN           | DAC Negative Output Current.   |
| A8   | IOUTP           | DAC Positive Output Current.   |
| A12, A13, B12, B13, C12, C13, D12, D13   | AVDD33          | 3.3 V Analog Supply.   |
| A14  | NC              | No Connect. Leave floating.  |
| B14  | I120            | Tie this pin to analog ground with a 10 kΩ resistor to generate a 120 μA reference current.  |
| C1   | CLKN            | Negative DAC Clock Input (DACCLK).   |
| C14  | VREF            | Band Gap Voltage Reference I/O. Decouple to analog ground with a 1 nF capacitor. Output impedance is approximately 5 kΩ.                       |
| D1   | CLKP            | Positive DAC Clock Input (DACCLK).   |
| D14  | IPTAT           | Factory Test Pin. Output current, proportional to absolute temperature, is approximately 10 μA at 25°C with a slope of approximately 20 nA/°C. |
| E11, E12   | DVDD18          | 1.8 V Digital Supply.  |
| G1, G2, G3, G4, G7, G8, G11, G12, G13, G14   | DVDD15          | 1.5 V Digital Supply.  |
| H1, H2, H3, H4, H7, H8, H11, H12, H13, H14, J1, J2, J3, J4, J11, J12, J13, J14   | DVSS            | Digital Supply Ground.   |
| K1, K2, K3, K4, K11, K12, K13, K14   | DVDD33          | 3.3 V Digital Supply.  |
| L1   | $\overline{CS}$ | Active Low Chip Select for SPI.  |
| L2, L3, M2, M3, N3, N4, P3, P4   | NC              | Not Used. Leave unconnected.   |
| L4   | P1/PARP         | CMOS/LVDS Parity Bit.  |
| L5   | D31/D15P        | CMOS/LVDS Data Input.  |
| L6   | D27/D13P        | CMOS/LVDS Data Input.  |
| L7   | D23/D11P        | CMOS/LVDS Data Input.  |
| L8   | D19/D9P         | CMOS/LVDS Data Input.  |
| L9   | D15/D7P         | CMOS/LVDS Data Input.  |
| L10  | D11/D5P         | CMOS/LVDS Data Input.  |
| L11  | D7/D3P          | CMOS/LVDS Data Input.  |
| L12  | D3/D1P          | CMOS/LVDS Data Input.  |
| L13  | FSP             | Positive LVDS Frame Sync (FSP) for Data Bus.   |
| L14  | CMOS_BUS        | Active High Input. Configures data bus for CMOS inputs. Low input configures data bus to accept LVDS inputs.                                   |
| M1   | SCLK            | Qualifying Clock for SPI.  |
| M4   | P0/PARN         | CMOS/LVDS Parity Bit.  |
| M5   | D30/D15N        | CMOS/LVDS Data Input.  |
| M6   | D26/D13N        | CMOS/LVDS Data Input.  |
| M7   | D22/D11N        | CMOS/LVDS Data Input.  |
| M8   | D18/D9N         | CMOS/LVDS Data Input.  |
| M9   | D14/D7N         | CMOS/LVDS Data Input.  |
| M10  | D10/D5N         | CMOS/LVDS Data Input.  |
| M11  | D6/D3N          | CMOS/LVDS Data Input.  |
| M12  | D2/D1N          | CMOS/LVDS Data Input.  |
| M13  | FSN             | Negative LVDS Frame Sync (FSN) for Data Bus.   |

| Pin No. | Mnemonic  | Description  |
|---------|-----------|--|
| M14     | CMOS_CTRL | Active High Input. Enables CMOS_DCO and CMOS_FS signals and disables DCOP/DCON and FSP/FSN signals. Low input disables CMOS_DCO and CMOS_FS signals and enables DCOP/DCON and FSP/FSN signals. |
| N1      | SDO       | Serial Data Output for SPI.  |
| N2      | RESET     | Active High Input. Resets the AD9789.  |
| N5      | D29/D14P  | CMOS/LVDS Data Input.  |
| N6      | D25/D12P  | CMOS/LVDS Data Input.  |
| N7      | D21/D10P  | CMOS/LVDS Data Input.  |
| N8      | D17/D8P   | CMOS/LVDS Data Input.  |
| N9      | D13/D6P   | CMOS/LVDS Data Input.  |
| N10     | D9/D4P    | CMOS/LVDS Data Input.  |
| N11     | D5/D2P    | CMOS/LVDS Data Input.  |
| N12     | D1/D0P    | CMOS/LVDS Data Input.  |
| N13     | DCOP      | Positive LVDS Data Clock Output (DCOP) for Data Bus.   |
| N14     | CMOS_FS   | CMOS Frame Sync for Data Bus.  |
| P1      | SDIO      | Serial Data Input/Output for SPI.  |
| P2      | IRQ       | Active Low, Open-Drain Interrupt Request Output. Pull up to DVDD33 with a 10 k $\Omega$ resistor.  |
| P5      | D28/D14N  | CMOS/LVDS Data Input.  |
| P6      | D24/D12N  | CMOS/LVDS Data Input.  |
| P7      | D20/D10N  | CMOS/LVDS Data Input.  |
| P8      | D16/D8N   | CMOS/LVDS Data Input.  |
| P9      | D12/D6N   | CMOS/LVDS Data Input.  |
| P10     | D8/D4N    | CMOS/LVDS Data Input.  |
| P11     | D4/D2N    | CMOS/LVDS Data Input.  |
| P12     | D0/D0N    | CMOS/LVDS Data Input.  |
| P13     | DCON      | Negative LVDS Data Clock Output (DCON) for Data Bus.   |
| P14     | CMOS_DCO  | CMOS Data Clock Output for Data Bus.   |

TYPICAL PERFORMANCE CHARACTERISTICS

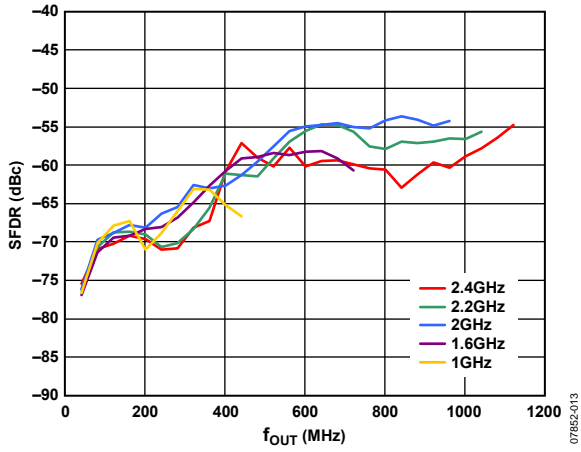

Figure 8. SFDR vs.  $f_{OUT}$  over  $f_{DAC}$ , Full-Scale Current = 20 mA, Digital Scale = 0 dBFS, Temperature = 25°C

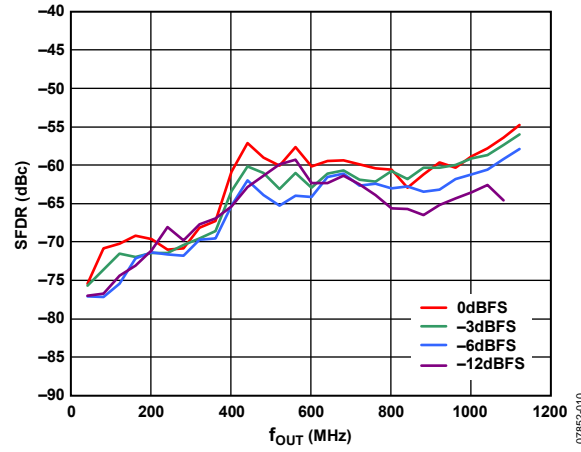

Figure 11. SFDR vs.  $f_{OUT}$  over Digital Full Scale,  $f_{DAC}$  = 2.4 GHz, Full-Scale Current = 20 mA, Temperature = 25°C

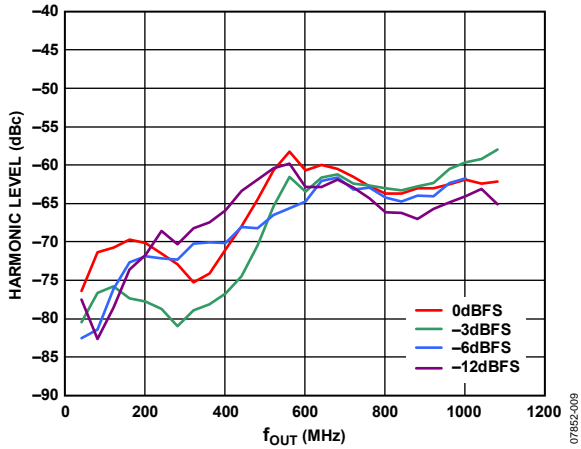

Figure 9. Second-Order Harmonic vs.  $f_{OUT}$  over Digital Full Scale,  $f_{DAC}$  = 2.4 GHz, Full-Scale Current = 20 mA, Temperature = 25°C

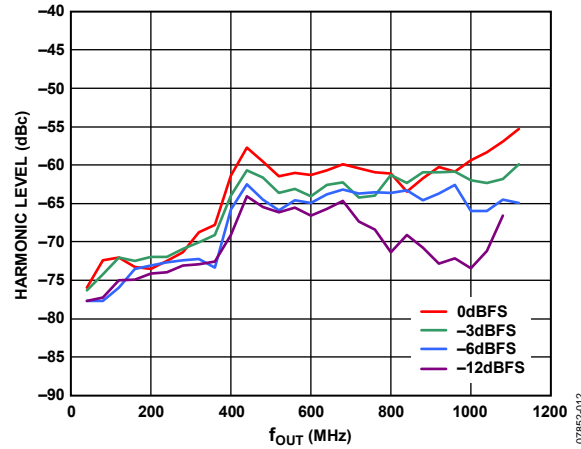

Figure 12. Third-Order Harmonic vs.  $f_{OUT}$  over Digital Full Scale,  $f_{DAC}$  = 2.4 GHz, Full-Scale Current = 20 mA, Temperature = 25°C

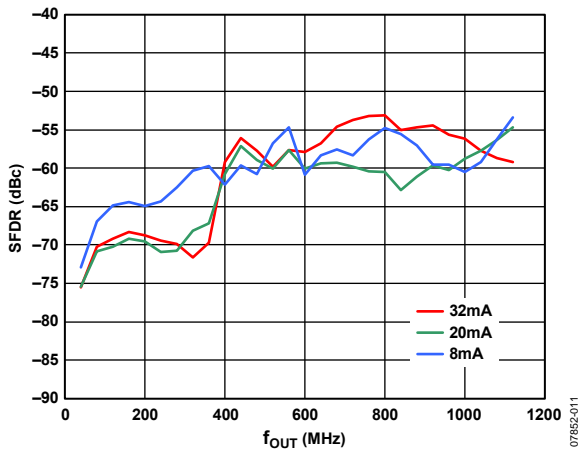

Figure 10. SFDR vs.  $f_{OUT}$  over Full-Scale Current,  $f_{DAC}$  = 2.4 GHz, Digital Scale = 0 dBFS, Temperature = 25°C

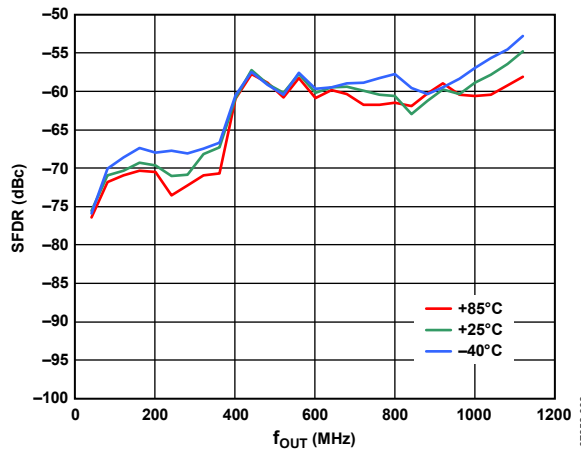

Figure 13. SFDR vs.  $f_{OUT}$  over Temperature,  $f_{DAC}$  = 2.4 GHz, Full-Scale Current = 20 mA, Digital Scale = 0 dBFS

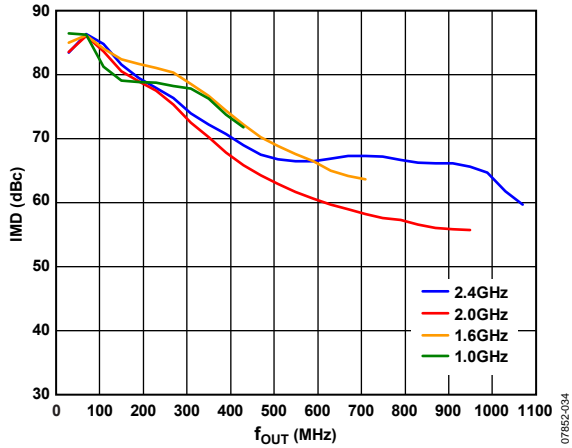

Figure 14. Third-Order IMD vs.  $f_{OUT}$  over  $f_{DAC}$ , Full-Scale Current = 20 mA, Digital Scale = 0 dBFS, Temperature = 25°C

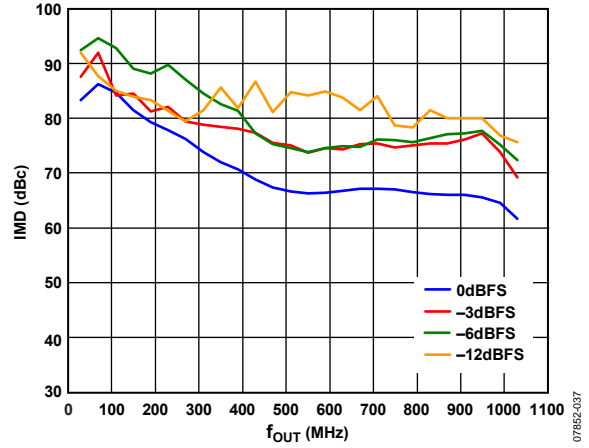

Figure 17. Third-Order IMD vs.  $f_{OUT}$  over Digital Full Scale,  $f_{DAC}$  = 2.4 GHz, Full-Scale Current = 20 mA, Temperature = 25°C

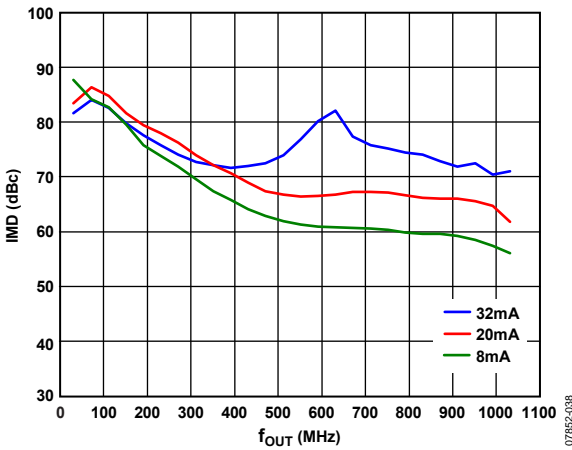

Figure 15. Third-Order IMD vs.  $f_{OUT}$  over Full-Scale Current,  $f_{DAC}$  = 2.4 GHz, Digital Scale = 0 dBFS, Temperature = 25°C

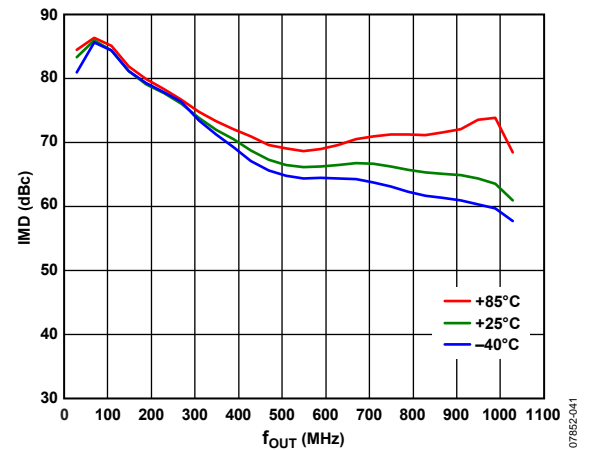

Figure 18. Third-Order IMD vs.  $f_{OUT}$  over Temperature,  $f_{DAC}$  = 2.4 GHz, Full-Scale Current = 20 mA, Digital Scale = 0 dBFS

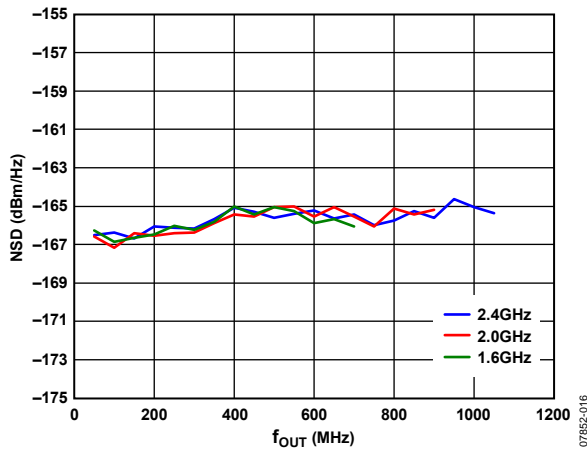

Figure 16. NSD vs.  $f_{OUT}$  over  $f_{DAC}$ , 1-Channel QAM, Full-Scale Current = 20 mA

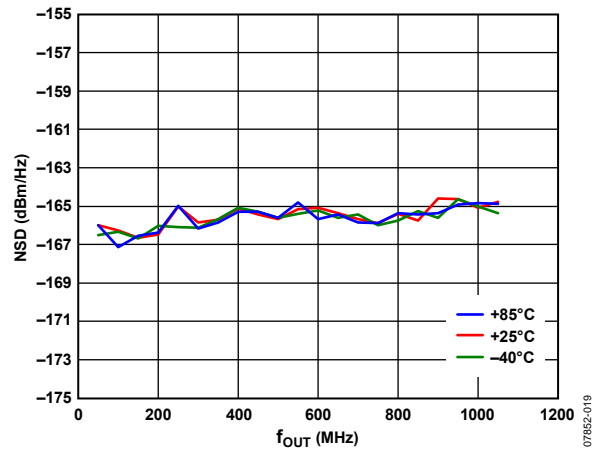

Figure 19. NSD vs.  $f_{OUT}$  over Temperature, 1-Channel QAM,  $f_{DAC}$  = 2.4 GHz, Full-Scale Current = 20 mA

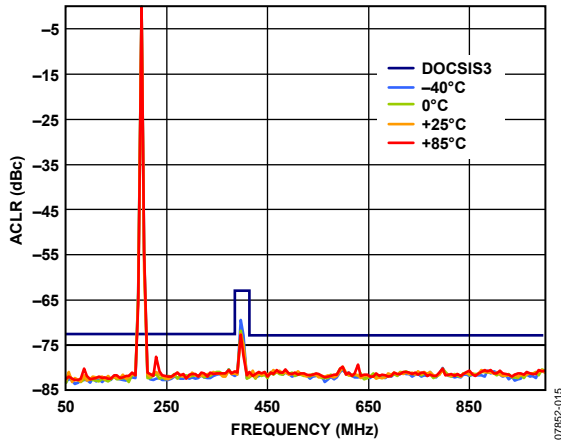

Figure 20. ACLR Performance over Temperature, 1-Channel QAM,  $f_{DAC} = 2.3$  GHz, Full-Scale Current = 20 mA,  $f_{OUT} = 200$  MHz, Sum Scale = 48 (DOCSIS SPEC Is -73 dBc; Harmonic Exception Is -63 dBc)

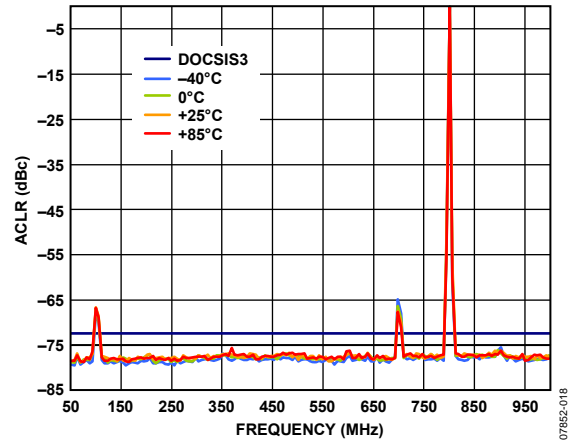

Figure 23. ACLR Performance over Temperature, 1-Channel QAM,  $f_{DAC} = 2.3$  GHz, Full-Scale Current = 20 mA,  $f_{OUT} = 800$  MHz, Sum Scale = 48 (DOCSIS SPEC Is -73 dBc)

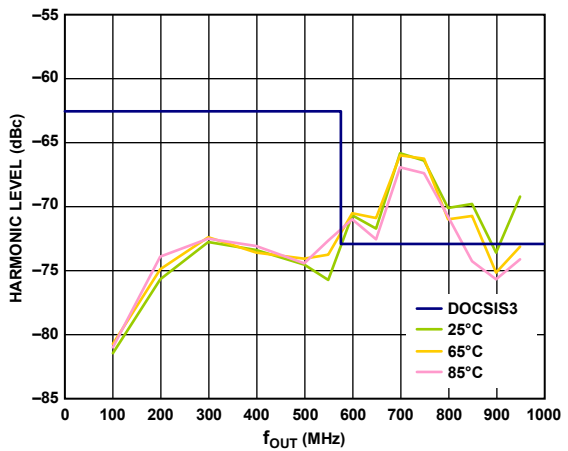

Figure 21. Second-Order Harmonic Performance vs.  $f_{OUT}$  over Temperature, 1-Channel QAM,  $f_{DAC} = 2.3$  GHz, Full-Scale Current = 20 mA, Sum Scale = 48 (DOCSIS SPEC Is -73 dBc; Harmonic Exception Is -63 dBc)

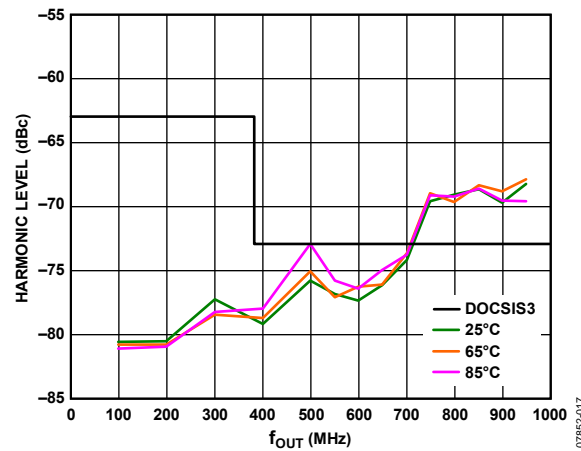

Figure 24. Third-Order Harmonic Performance vs.  $f_{OUT}$  over Temperature, 1-Channel QAM,  $f_{DAC} = 2.3$  GHz, Full-Scale Current = 20 mA, Sum Scale = 48 (DOCSIS SPEC Is -73 dBc; Harmonic Exception Is -63 dBc)

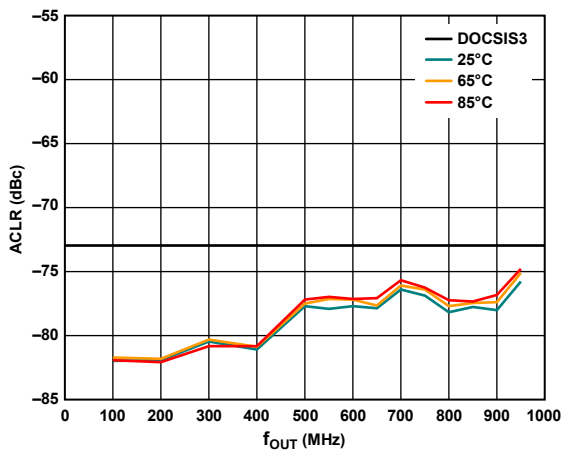

Figure 22. Noise Floor vs.  $f_{OUT}$  over Temperature (ACLR Measured Beyond 30 MHz), 1-Channel QAM,  $f_{DAC} = 2.3$  GHz, Full-Scale Current = 20 mA, Sum Scale = 48 (DOCSIS SPEC Is -73 dBc)

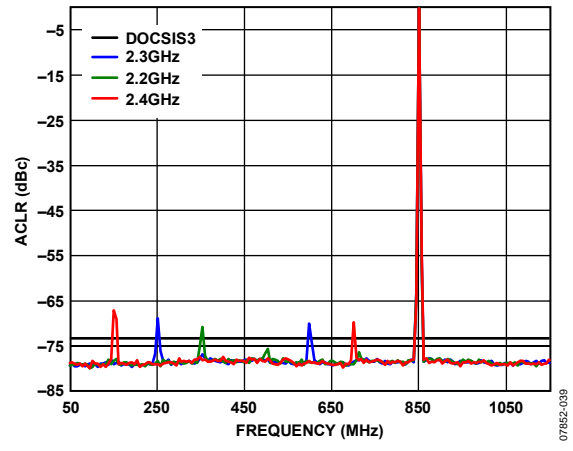

Figure 25. ACLR Performance over  $f_{DAC}$ , 1-Channel QAM,  $f_{OUT} = 850$  MHz, Full-Scale Current = 20 mA, Temperature = 25°C, Sum Scale = 48 (DOCSIS SPEC Is -73 dBc)

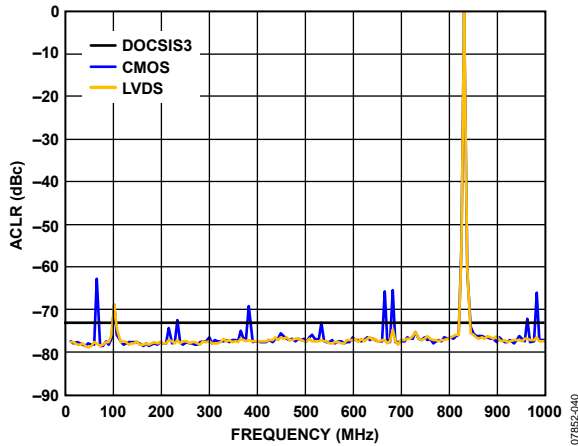

Figure 26. ACLR Performance for CMOS and LVDS Interfaces, 1-Channel QAM,  $f_{OUT} = 840$  MHz,  $f_{DAC} = 2.4$  GHz, Full-Scale Current = 20 mA, Sum Scale = 48 (DOCSIS SPEC Is -73 dBc)

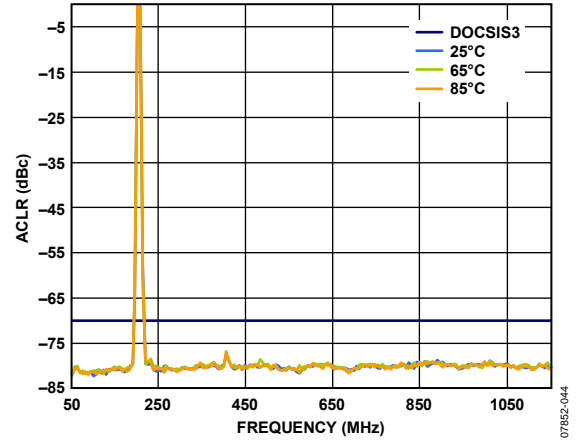

Figure 29. ACLR Performance over Temperature, 2-Channel QAM,  $f_{OUT} = 200$  MHz,  $f_{DAC} = 2.3$  GHz, Full-Scale Current = 25 mA, Sum Scale = 32 (DOCSIS SPEC Is -70 dBc; Harmonic Exception Is -63 dBc)

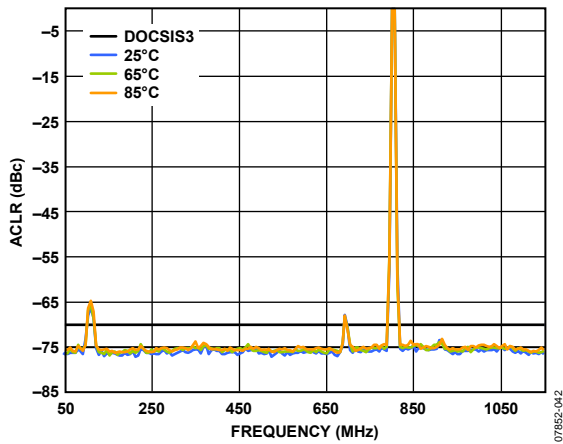

Figure 27. ACLR Performance over Temperature, 2-Channel QAM,  $f_{OUT} = 800$  MHz,  $f_{DAC} = 2.3$  GHz, Full-Scale Current = 25 mA, Sum Scale = 32 (DOCSIS SPEC Is -70 dBc)

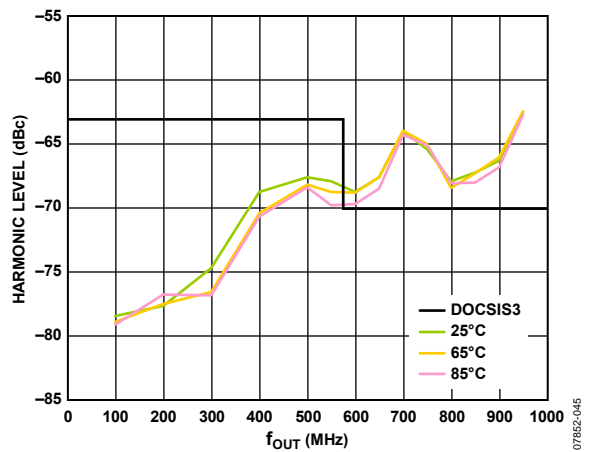

Figure 30. Second Harmonic Performance vs.  $f_{OUT}$  over Temperature, 2-Channel QAM,  $f_{DAC} = 2.3$  GHz, Full-Scale Current = 25 mA, Sum Scale = 32 (DOCSIS SPEC Is -70 dBc; Harmonic Exception Is -63 dBc)

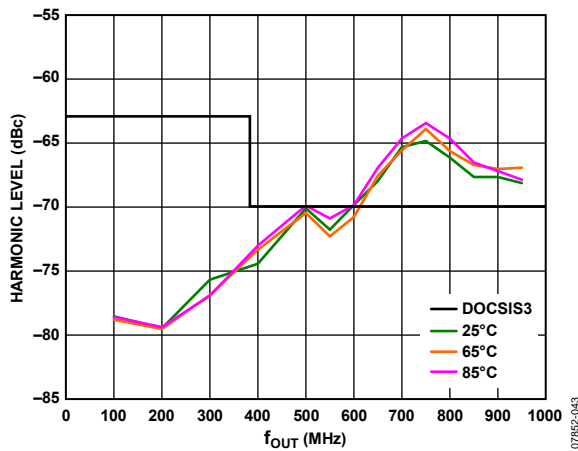

Figure 28. Third-Order Harmonic Performance vs.  $f_{OUT}$  over Temperature, 2-Channel QAM,  $f_{DAC} = 2.3$  GHz, Full-Scale Current = 25 mA, Sum Scale = 32 (DOCSIS SPEC Is -70 dBc; Harmonic Exception Is -63 dBc)

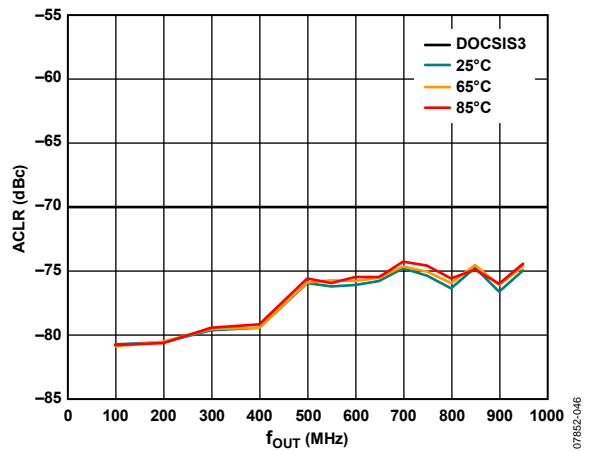

Figure 31. Noise Floor vs.  $f_{OUT}$  over Temperature (ACLR Measured Beyond 30 MHz), 2-Channel QAM,  $f_{DAC} = 2.3$  GHz, Full-Scale Current = 25 mA, Sum Scale = 32 (DOCSIS SPEC Is -70 dBc)



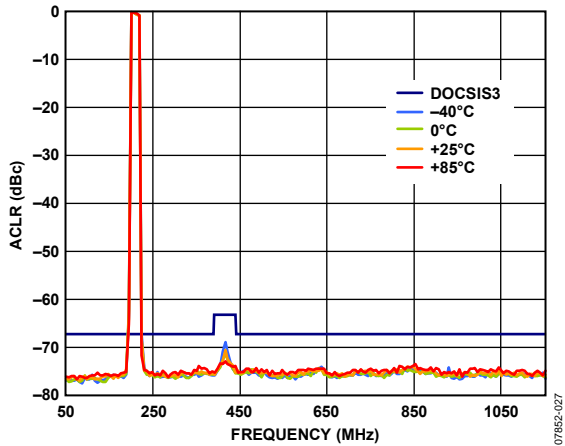

Figure 32. ACLR Performance over Temperature, 4-Channel QAM,  $f_{OUT} = 200$  MHz,  $f_{DAC} = 2.3$  GHz, Full-Scale Current = 25 mA, Sum Scale = 20 (DOCSIS SPEC Is -67 dBc; Harmonic Exception Is -63 dBc)

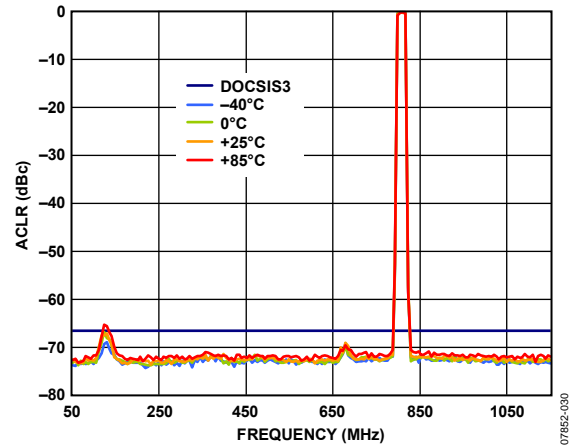

Figure 35. ACLR Performance over Temperature, 4-Channel QAM,  $f_{OUT} = 800$  MHz,  $f_{DAC} = 2.3$  GHz, Full-Scale Current = 25 mA, Sum Scale = 20 (DOCSIS SPEC Is -67 dBc)

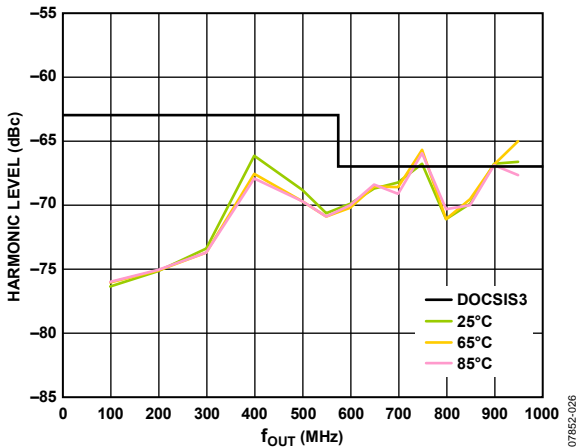

Figure 33. Second-Order Harmonic Performance vs.  $f_{OUT}$  over Temperature, 4-Channel QAM,  $f_{DAC} = 2.3$  GHz, Full-Scale Current = 25 mA, Sum Scale = 20 (DOCSIS SPEC Is -67 dBc; Harmonic Exception Is -63 dBc)

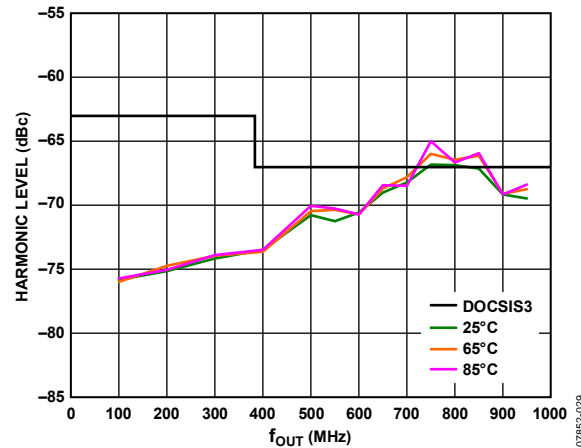

Figure 36. Third-Order Harmonic Performance vs.  $f_{OUT}$  over Temperature, 4-Channel QAM,  $f_{DAC} = 2.3$  GHz, Full-Scale Current = 25 mA, Sum Scale = 20 (DOCSIS SPEC Is -67 dBc; Harmonic Exception Is -63 dBc)

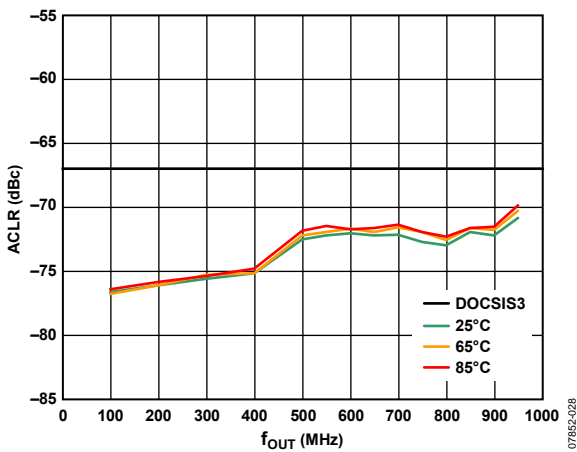

Figure 34. Noise Floor vs.  $f_{OUT}$  over Temperature (ACLR Measured Beyond 30 MHz), 4-Channel QAM,  $f_{DAC} = 2.3$  GHz, Full-Scale Current = 25 mA, Sum Scale = 20 (DOCSIS SPEC Is -67 dBc)

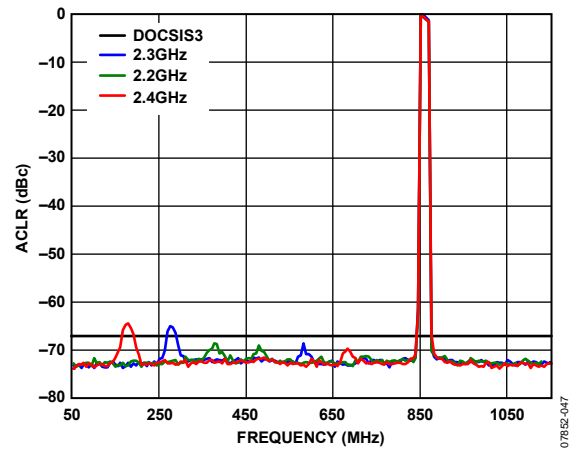

Figure 37. ACLR Performance over  $f_{DAC}$ , 4-Channel QAM,  $f_{OUT} = 850$  MHz, Full-Scale Current = 25 mA, Temperature = 25°C, Sum Scale = 20 (DOCSIS SPEC Is -67 dBc)

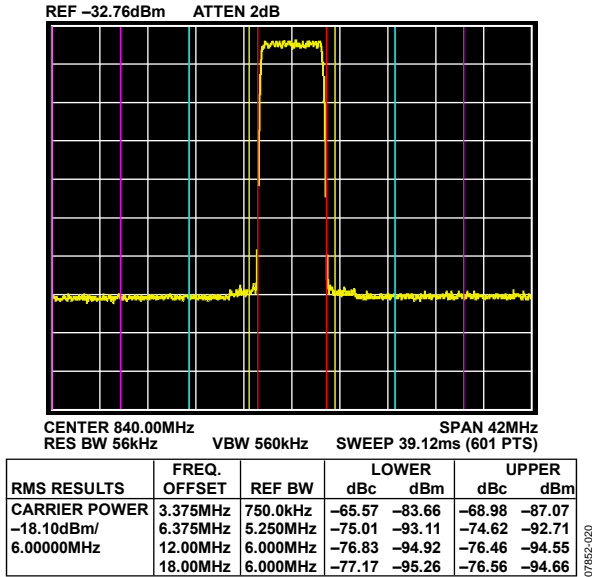

Figure 38. 1-Channel QAM ACLR,  $f_{OUT} = 840$  MHz, Temperature = 25°C, Sum Scale = 48, Full-Scale Current = 20 mA, Span = 42 MHz

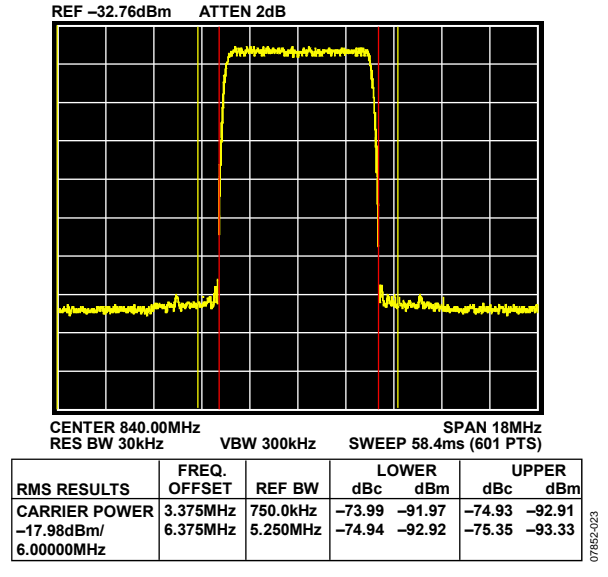

Figure 40. 1-Channel QAM ACLR,  $f_{OUT} = 840$  MHz, Temperature = 25°C, Sum Scale = 48, Full-Scale Current = 20 mA, Span = 18 MHz

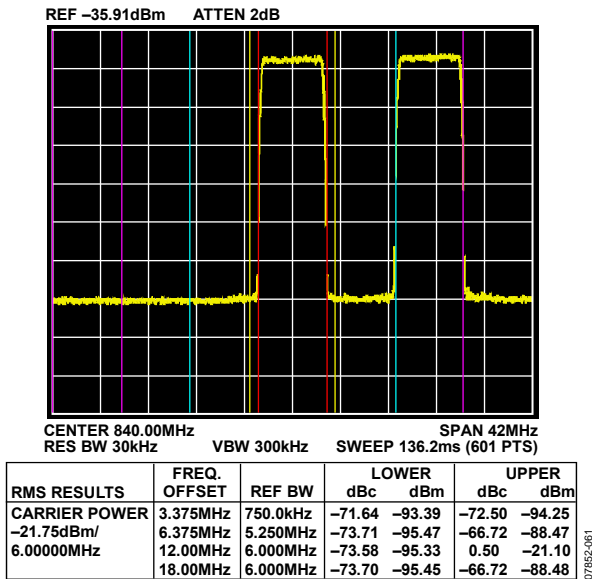

Figure 39. 2-Channel QAM ACLR,  $f_{OUT} = 840$  MHz, Sum Scale = 32, Full-Scale Current = 25 mA, Span = 42 MHz, Channel 1

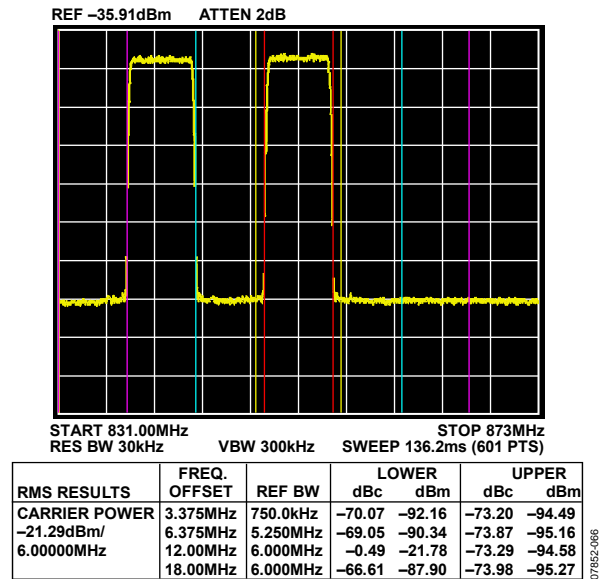
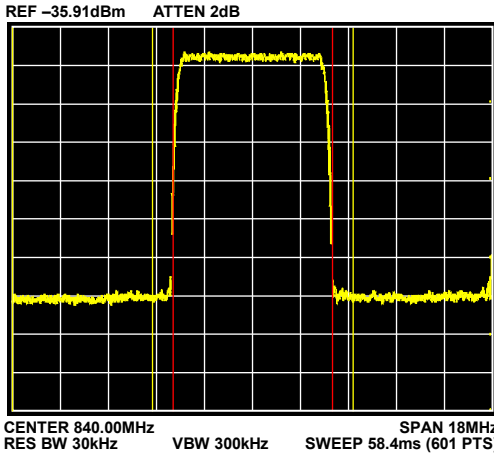
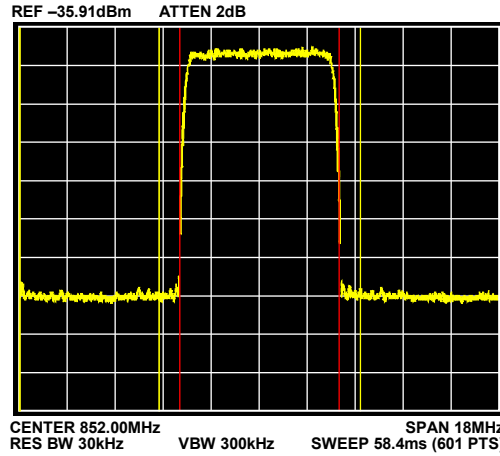

Figure 41. 2-Channel QAM ACLR,  $f_{OUT} = 840$  MHz, Sum Scale = 32, Full-Scale Current = 25 mA, Span = 42 MHz, Channel 2



| RMS RESULTS   | FREQ. OFFSET | REF BW   | LOWER  |        | UPPER  |        |
|---------------|--------------|----------|--------|--------|--------|--------|
|               |              |          | dBc    | dBm    | dBc    | dBm    |
| CARRIER POWER | 3.375MHz     | 750.0kHz | -75.37 | -96.93 | -75.56 | -97.11 |
| -21.56dBm/    | 6.375MHz     | 5.250MHz | -73.85 | -95.41 | -72.54 | -94.10 |
| 6.00000MHz    |              |          |        |        |        |        |

Figure 42. Zoomed 2-Channel QAM ACLR,  $f_{OUT} = 840$  MHz, Sum Scale = 32, Full-Scale Current = 25 mA, Span = 18 MHz, Channel 1



| RMS RESULTS   | FREQ. OFFSET | REF BW   | LOWER  |        | UPPER  |        |
|---------------|--------------|----------|--------|--------|--------|--------|
|               |              |          | dBc    | dBm    | dBc    | dBm    |
| CARRIER POWER | 3.375MHz     | 750.0kHz | -75.51 | -96.54 | -75.17 | -96.20 |
| -21.03dBm/    | 6.375MHz     | 5.250MHz | -72.55 | -93.58 | -73.90 | -94.93 |
| 6.00000MHz    |              |          |        |        |        |        |

Figure 44. Zoomed 2-Channel QAM ACLR,  $f_{OUT} = 840$  MHz, Sum Scale = 32, Full-Scale Current = 25 mA, Span = 18 MHz, Channel 2

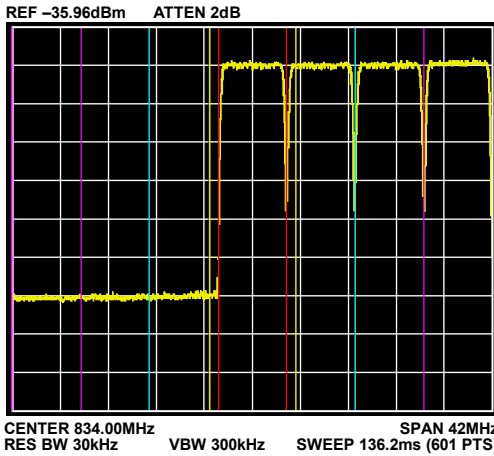

| RMS RESULTS   | FREQ. OFFSET | REF BW   | LOWER  |        | UPPER  |        |
|---------------|--------------|----------|--------|--------|--------|--------|
|               |              |          | dBc    | dBm    | dBc    | dBm    |
| CARRIER POWER | 3.375MHz     | 750.0kHz | -70.33 | -93.96 | -11.07 | -34.70 |
| -23.63dBm/    | 6.375MHz     | 5.250MHz | -69.04 | -92.67 | -0.49  | -24.12 |
| 6.00000MHz    | 12.00MHz     | 6.000MHz | -70.38 | -94.01 | 0.00   | -23.63 |
|               | 18.00MHz     | 6.000MHz | -71.02 | -94.65 | 0.43   | -23.20 |

Figure 43. 4-Channel QAM ACLR,  $f_{OUT} = 840$  MHz, Temperature = 25°C, Sum Scale = 20, Full-Scale Current = 25 mA, Span = 42 MHz, Channel 1

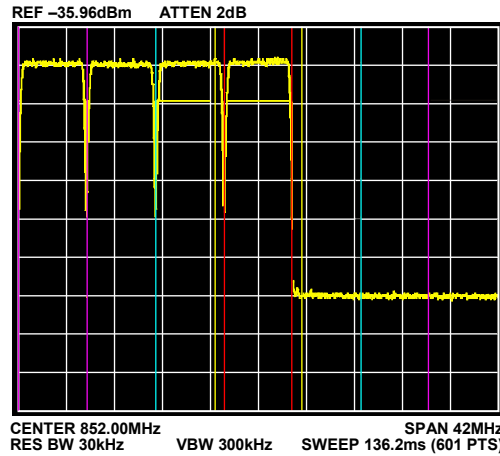

| RMS RESULTS   | FREQ. OFFSET | REF BW   | LOWER  |        | UPPER  |        |
|---------------|--------------|----------|--------|--------|--------|--------|
|               |              |          | dBc    | dBm    | dBc    | dBm    |
| CARRIER POWER | 3.375MHz     | 750.0kHz | -11.10 | -34.32 | -72.19 | -95.42 |
| -23.23dBm/    | 6.375MHz     | 5.250MHz | -0.75  | -23.98 | -68.97 | -92.20 |
| 6.00000MHz    | 12.00MHz     | 6.000MHz | -0.59  | -23.81 | -70.32 | -93.55 |
|               | 18.00MHz     | 6.000MHz | -0.35  | -23.58 | -70.70 | -93.93 |

Figure 45. 4-Channel QAM ACLR,  $f_{OUT} = 840$  MHz, Temperature = 25°C, Sum Scale = 20, Full-Scale Current = 25 mA, Span = 42 MHz, Channel 4

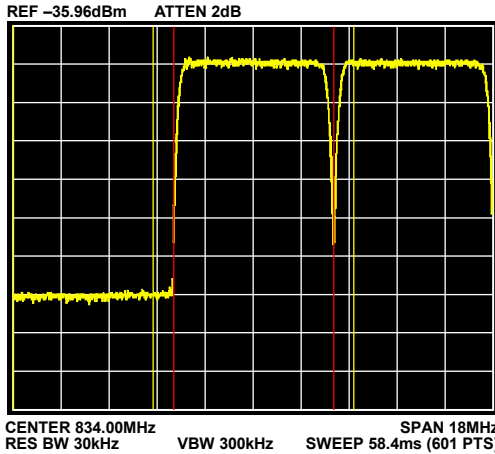

| RMS RESULTS          | FREQ. OFFSET | REF BW   | LOWER  |        | UPPER  |        |
|----------------------|--------------|----------|--------|--------|--------|--------|
|                      |              |          | dBc    | dBm    | dBc    | dBm    |
| CARRIER POWER        | 3.375MHz     | 750.0kHz | -72.95 | -96.56 | -10.86 | -34.48 |
| -23.62dBm/6.00000MHz | 6.375MHz     | 5.250MHz | -69.38 | -92.99 | -0.51  | -24.13 |

Figure 46. Zoomed 4-Channel QAM ACLR,  $f_{OUT} = 840$  MHz, Temperature = 25°C, Sum Scale = 20, Full-Scale Current = 25 mA, Span = 18 MHz, Channel 1

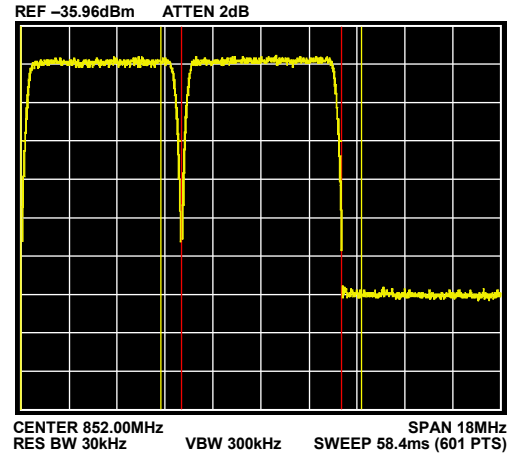

| RMS RESULTS          | FREQ. OFFSET | REF BW   | LOWER  |        | UPPER  |        |
|----------------------|--------------|----------|--------|--------|--------|--------|
|                      |              |          | dBc    | dBm    | dBc    | dBm    |
| CARRIER POWER        | 3.375MHz     | 750.0kHz | -11.20 | -34.40 | -74.44 | -97.64 |
| -23.20dBm/6.00000MHz | 6.375MHz     | 5.250MHz | -0.77  | -23.96 | -69.07 | -92.26 |

Figure 49. Zoomed 4-Channel QAM ACLR,  $f_{OUT} = 840$  MHz, Temperature = 25°C, Sum Scale = 20, Full-Scale Current = 25 mA, Span = 18 MHz, Channel 4

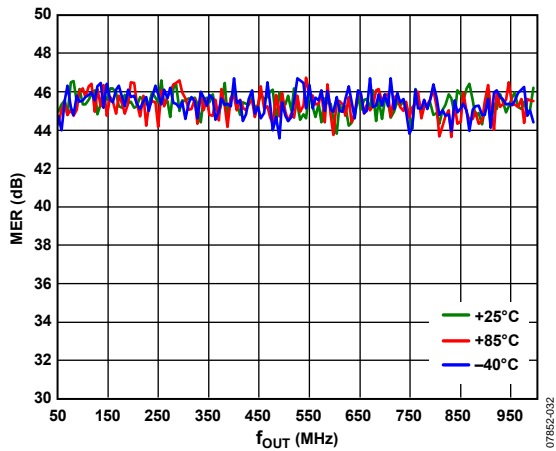

Figure 47. Modulation Error Ratio, Equalized, 1-Channel 256-QAM,  $f_{DAC} = 2.29376$  GHz, Full-Scale Current = 20 mA, Sum Scale = 48 (Equalization Filter from Demodulation Toolbox on Spectrum Analyzer Used)

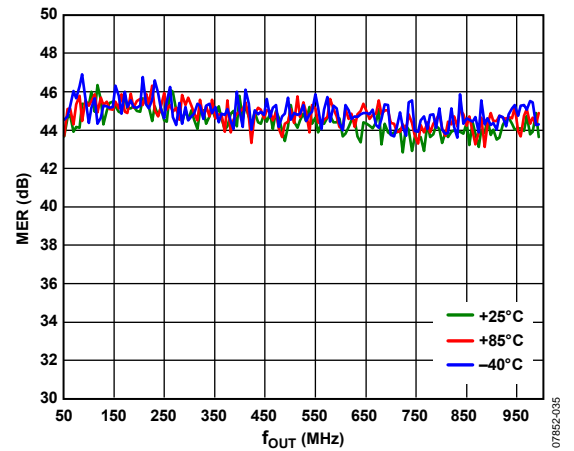

Figure 50. Modulation Error Ratio, Equalized, 4-Channel 256-QAM,  $f_{DAC} = 2.29376$  GHz, Full-Scale Current = 25 mA, Sum Scale = 20 (Equalization Filter from Demodulation Toolbox on Spectrum Analyzer Used)

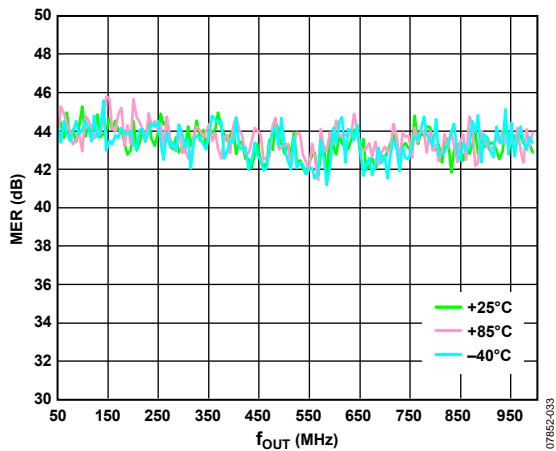

Figure 48. Modulation Error Ratio, Unequalized, 1-Channel 256-QAM,  $f_{DAC} = 2.29376$  GHz, Full-Scale Current = 20 mA, Sum Scale = 48

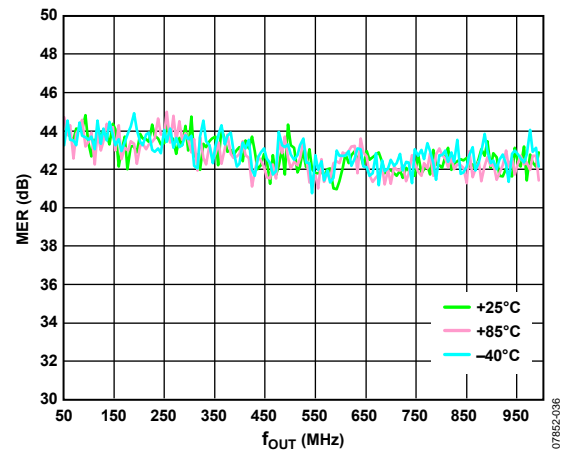

Figure 51. Modulation Error Ratio, Unequalized, 4-Channel 256-QAM,  $f_{DAC} = 2.29376$  GHz, Full-Scale Current = 25 mA, Sum Scale = 20

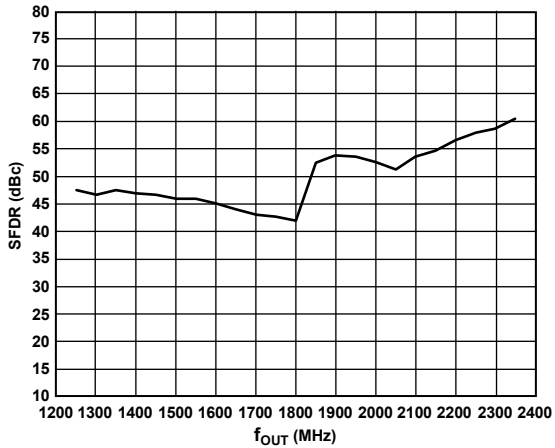

Figure 52. SFDR vs.  $f_{OUT}$  in Mix Mode,  $f_{DAC} = 2.4$  GHz, Full-Scale Current = 20 mA (Second Nyquist Zone Performance)

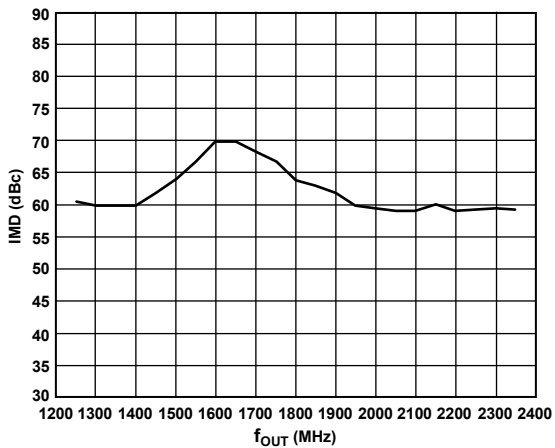

Figure 53. IMD vs.  $f_{OUT}$  in Mix Mode,  $f_{DAC} = 2.4$  GHz, Full-Scale Current = 20 mA (Second Nyquist Zone Performance)

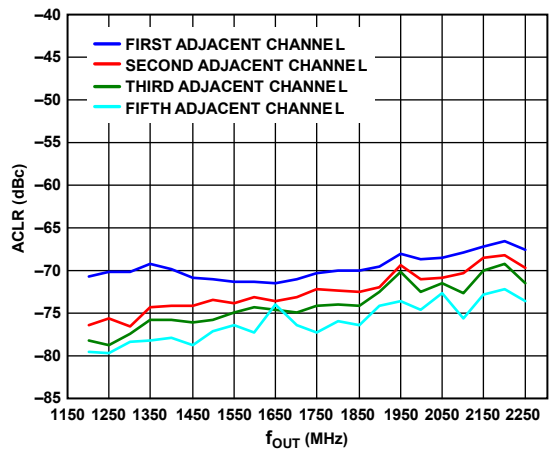
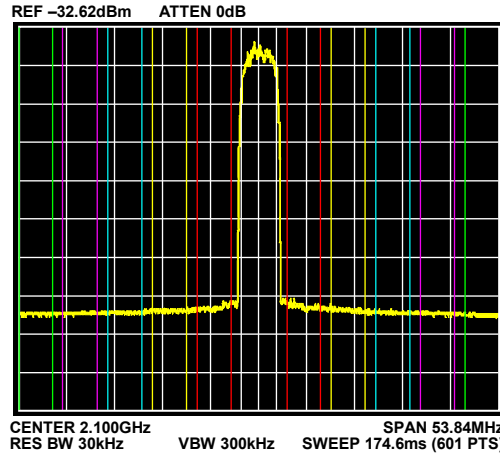
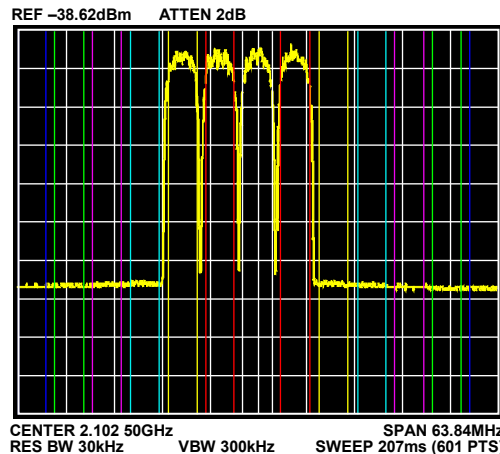

Figure 54. ACLR vs.  $f_{OUT}$  in Mix Mode with One-Carrier WCDMA,  $f_{DAC} = 2304$  MHz, Full-Scale Current = 20 mA (Second Nyquist Zone Performance)



| RMS RESULTS   | FREQ. OFFSET | REF BW   | LOWER  |        | UPPER  |        |
|---------------|--------------|----------|--------|--------|--------|--------|
|               |              |          | dBc    | dBm    | dBc    | dBm    |
| CARRIER POWER | 5.000MHz     | 3.840MHz | -68.93 | -88.88 | -67.99 | -87.94 |
| -19.95dBm/    | 10.00MHz     | 3.840MHz | -71.31 | -91.26 | -70.42 | -90.37 |
| 3.84000MHz    | 15.00MHz     | 3.840MHz | -73.43 | -93.37 | -72.68 | -92.63 |
|               | 20.00MHz     | 3.840MHz | -75.12 | -95.07 | -74.89 | -94.84 |
|               | 25.00MHz     | 3.840MHz | -75.60 | -95.55 | -76.51 | -96.46 |

Figure 55. One-Carrier WCDMA ACLR in Mix Mode,  $f_{OUT} = 2.1$  GHz,  $f_{DAC} = 2304$  MHz, Full-Scale Current = 20 mA



| RMS RESULTS   | FREQ. OFFSET | REF BW   | LOWER  |        | UPPER  |        |
|---------------|--------------|----------|--------|--------|--------|--------|
|               |              |          | dBc    | dBm    | dBc    | dBm    |
| CARRIER POWER | 5.000MHz     | 3.840MHz | -0.25  | -26.31 | -0.42  | -26.47 |
| -26.06dBm/    | 10.00MHz     | 3.840MHz | -0.42  | -26.48 | -63.50 | -89.56 |
| 3.84000MHz    | 15.00MHz     | 3.840MHz | -64.07 | -90.13 | -65.13 | -91.18 |
|               | 20.00MHz     | 3.840MHz | -65.36 | -91.42 | -66.97 | -93.03 |
|               | 25.00MHz     | 3.840MHz | -66.86 | -92.92 | -68.70 | -94.76 |
|               | 30.00MHz     | 3.840MHz | -67.83 | -93.89 | -68.64 | -94.70 |

Figure 56. Four-Carrier WCDMA ACLR in Mix Mode,  $f_{OUT} = 2.1$  GHz,  $f_{DAC} = 2304$  MHz, Full-Scale Current = 20 mA

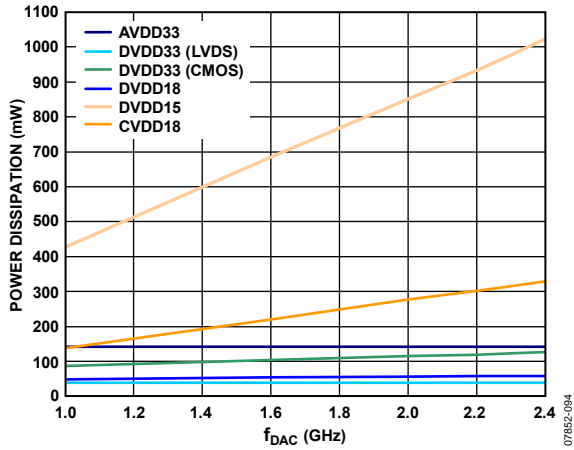

Figure 57. Power Dissipation by Supply vs.  $f_{DAC}$ , 4-Channel DOCSIS,  $f_{OUT} = 915$  MHz, Full-Scale Current = 25 mA (Datapath Configuration: QAM Encoder On, SRRC Filter On, Four 2× Interpolation Filters On)

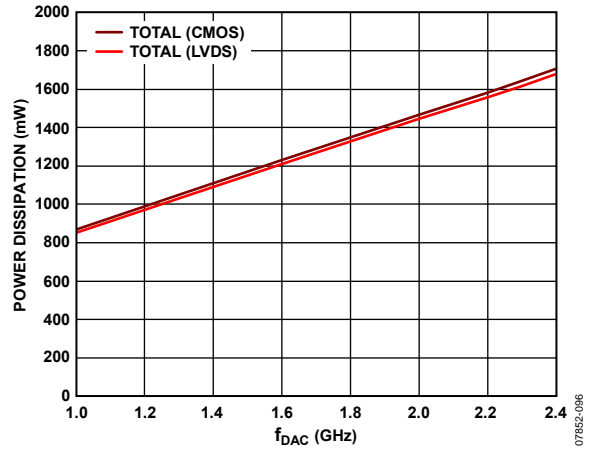

Figure 60. Total Power Dissipation vs.  $f_{DAC}$ , 4-Channel DOCSIS,  $f_{OUT} = 915$  MHz, Full-Scale Current = 25 mA (Datapath Configuration: QAM Encoder On, SRRC Filter On, Four 2× Interpolation Filters On)

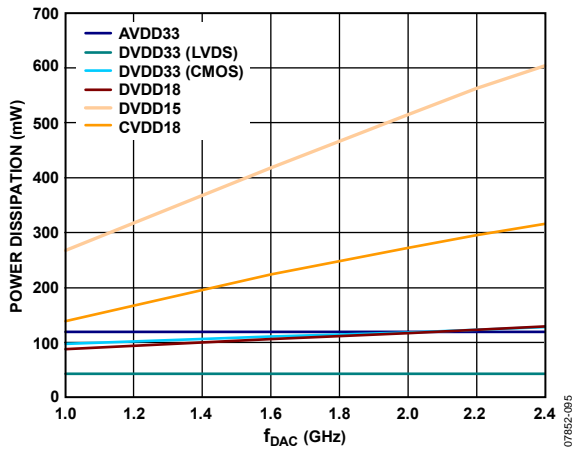

Figure 58. Power Dissipation by Supply vs.  $f_{DAC}$ , 16× Interpolation, One Channel Enabled,  $f_{OUT} = 70$  MHz, Full-Scale Current = 20 mA

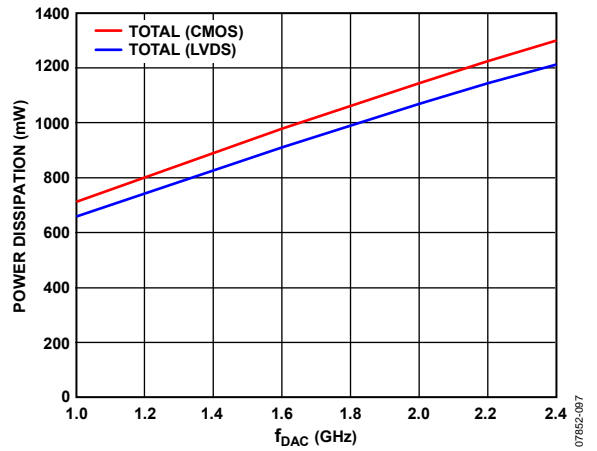

Figure 61. Total Power Dissipation vs.  $f_{DAC}$ , 16× Interpolation, One Channel Enabled,  $f_{OUT} = 70$  MHz, Full-Scale Current = 20 mA

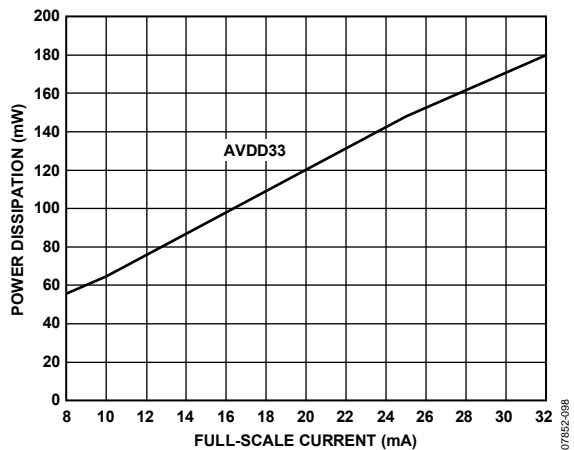

Figure 59. AVDD33 Power Dissipation vs. Full-Scale Current

## TERMINOLOGY

### Monotonicity

A DAC is monotonic if the output either increases or remains constant as the digital input increases.

### Offset Error

Offset error is the deviation of the output current from the ideal of 0. For IOUTP, 0 mA output is expected when all inputs are set to 0. For IOUTN, 0 mA output is expected when all inputs are set to 1.

### Gain Error

Gain error is the difference between the actual and ideal output span. The actual span is determined by the output when all inputs are set to 1s minus the output when all inputs are set to 0s.

### Temperature Drift

Temperature drift is specified as the maximum change from the ambient (25°C) value to the value at either  $T_{MIN}$  or  $T_{MAX}$ . For offset, gain, and reference drift, the drift is reported in ppm per °C.

### Power Supply Rejection (PSR)

PSR is the maximum change in the full-scale output as the supplies are varied from nominal to minimum and maximum specified voltages.

### Output Compliance Range

The output compliance range is the range of allowable voltage at the output of a current output DAC. Operation beyond the maximum compliance limits may cause either output stage saturation or breakdown, resulting in nonlinear performance.

### Spurious-Free Dynamic Range (SFDR)

SFDR is the difference, in dB, between the peak amplitude of the output signal and the peak spurious signal over the specified bandwidth.

### Noise Spectral Density (NSD)

NSD is the converter noise power per unit of bandwidth. NSD is usually specified in dBm/Hz in the presence of a 0 dBm full-scale signal.

### Adjacent Channel Leakage Ratio (ACLR)

The adjacent channel leakage (power) ratio is the ratio, in dBc, between the measured power within a channel relative to its adjacent channels.

### Modulation Error Ratio (MER)

Modulated signals create a discrete set of output values referred to as a constellation. Each symbol creates an output signal corresponding to one point on the constellation. MER is a measure of the discrepancy between the average output symbol magnitude and the rms error magnitude of the individual symbol.

### Intermodulation Distortion (IMD)

IMD is the result of two or more signals at different frequencies mixing together. Many products are created according to the formula  $af_1 \pm bf_2$ , where a and b are integer values.

## SERIAL CONTROL PORT

The AD9789 serial control port is a flexible, synchronous serial communications port that allows an easy interface to many industry-standard microcontrollers and microprocessors. The AD9789 serial control port is compatible with most synchronous transfer formats, including both the Motorola SPI® and Intel® SSR protocols. The serial control port allows read/write access to all registers that configure the AD9789. Single- or multiple-byte transfers are supported, as well as MSB first or LSB first transfer formats. The AD9789 serial control port can be configured for a single bidirectional I/O pin (SDIO only) or for two unidirectional I/O pins (SDIO/SDO). By default, the AD9789 is in unidirectional long instruction mode (long instruction mode is the only instruction mode supported).

### SERIAL CONTROL PORT PIN DESCRIPTIONS

The SCLK (serial clock) pin is the serial shift clock. This pin is an input. SCLK is used to synchronize serial control port reads and writes. Write data bits are registered on the rising edge of this clock, and read data bits are registered on the falling edge. This pin is internally pulled down by a 30 kΩ resistor to ground.

SDIO (serial data input/output) is a dual-purpose pin that acts as an input only (unidirectional mode) or as both an input and an output (bidirectional mode). The AD9789 defaults to the unidirectional I/O mode (Register 0x00[7] = 0).

The SDO (serial data output) pin is used only in the unidirectional I/O mode as a separate output pin for reading back data.

$\overline{\text{CS}}$  (chip select bar) is an active low control that gates the read and write cycles. When  $\overline{\text{CS}}$  is high, SDO and SDIO are in a high impedance state. This pin is internally pulled up by a 30 kΩ resistor to DVDD33.

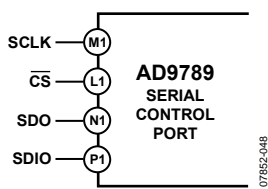

Figure 62. Serial Control Port

### GENERAL OPERATION OF SERIAL CONTROL PORT

A write or read operation to the AD9789 is initiated by pulling  $\overline{\text{CS}}$  low.  $\overline{\text{CS}}$  stall high is supported in modes where three or fewer bytes of data (plus the instruction data) are transferred (see Table 7). In these modes,  $\overline{\text{CS}}$  can temporarily return high on any byte boundary, allowing time for the system controller to process the next byte.  $\overline{\text{CS}}$  can go high on byte boundaries only and can go high during either part (instruction or data) of the transfer.

During  $\overline{\text{CS}}$  stall high mode, the serial control port state machine enters a wait state until all data is sent. If the system controller decides to abort the transfer before all of the data is sent, the state machine must be reset by either completing the remaining

transfers or by returning  $\overline{\text{CS}}$  low for at least one complete SCLK cycle (but less than eight SCLK cycles). Raising  $\overline{\text{CS}}$  on a nonbyte boundary terminates the serial transfer and flushes the buffer.

In streaming mode (see Table 7), any number of data bytes can be transferred in a continuous stream. The register address is automatically incremented or decremented (see the MSB/LSB First Transfers section).  $\overline{\text{CS}}$  must be raised at the end of the last byte to be transferred, thereby ending streaming mode.

### Communication Cycle—Instruction Plus Data

There are two parts to a communication cycle with the AD9789. In the first part, a 16-bit instruction word is written to the AD9789, coincident with the first 16 SCLK rising edges. The instruction word provides the AD9789 serial control port with information regarding the data transfer, which is the second part of the communication cycle. The instruction word defines whether the upcoming data transfer is a read or a write, the number of bytes in the data transfer, and the starting register address for the first byte of the data transfer.

### Write

If the instruction word is for a write operation, the second part of the communication cycle is the transfer of data into the serial control port buffer of the AD9789. Data bits are registered on the rising edge of SCLK.

The length of the transfer (one, two, or three bytes or streaming mode) is indicated by two bits (N1 and N0) in the instruction byte. When the transfer is one, two, or three bytes (but not streaming mode),  $\overline{\text{CS}}$  can be raised after each sequence of eight bits to stall the bus, except after the last byte, where it ends the cycle. When the bus is stalled, the serial transfer resumes when  $\overline{\text{CS}}$  is lowered. Raising  $\overline{\text{CS}}$  on a nonbyte boundary resets the serial control port. During a write, streaming mode does not skip reserved or blank registers; therefore, the user must know what bit pattern to write to the reserved registers to preserve proper operation of the part. It does not matter what data is written to blank registers.

Most writes to the control registers immediately reconfigure the device. However, Register 0x16 through Register 0x1D do not directly control device operation. They provide data to internal logic that must perform additional operations on the data before it is downloaded and the device configuration is changed. For any updates to Register 0x16 through Register 0x1D to take effect, the **FREQNEW** bit (Register 0x1E[7]) must be set to 1 (this bit is self-clearing). Any number of bytes of data can be changed before updating registers. Setting the **FREQNEW** bit simultaneously updates Register 0x16 through Register 0x1D.

In a similar fashion, any changes to Register 0x22 and Register 0x23 require **PARMNEW** (Register 0x24[7]) to be toggled from a low state to a high state before the new values take effect. Unlike the **FREQNEW** bit, **PARMNEW** is not self-clearing.



## Read

If the instruction word is for a read operation, the next  $N \times 8$  SCLK cycles clock out the data from the address specified in the instruction word, where  $N$  is 1 to 3 as determined by Bits[N1:N0]. If  $N = 4$ , the read operation is in streaming mode, continuing until  $\overline{CS}$  is raised. Streaming mode does not skip over reserved or blank registers. The readback data is valid on the falling edge of SCLK.

The default mode of the AD9789 serial control port is the unidirectional mode. In unidirectional mode, the readback data appears on the SDO pin. It is also possible to set the AD9789 to bidirectional mode using the SDIO\_DIR bit (Register 0x00[7]). In bidirectional mode, both the sent data and the readback data appear on the SDIO pin.

A readback request reads the data that is in the serial control port buffer area or the data in the active registers (see Figure 63).

The AD9789 supports only the long instruction mode; therefore, Register 0x00[4:3] reads 11 (this register uses mirrored bits). Long instruction mode is the default at power-up or reset, and writing to these bits has no effect.

The AD9789 uses Register Address 0x00 to Register Address 0x55.

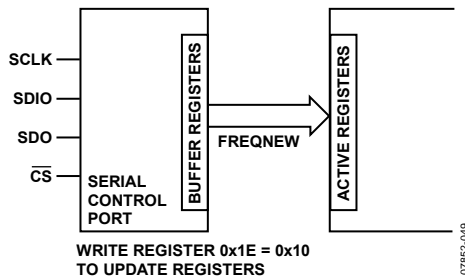

Figure 63. Relationship Between Serial Control Port Buffer Registers and Active Registers of the AD9789

## INSTRUCTION WORD (16 BITS)

The MSB of the instruction word is  $R/\overline{W}$ , which indicates whether the instruction is a read or a write. The next two bits, N1 and N0, indicate the length of the transfer in bytes. The final 13 bits (Bits[A12:A0]) are the address at which to begin the read or write operation.

For a write, the instruction word is followed by the number of bytes of data indicated by Bits[N1:N0] (see Table 7).

Table 7. Byte Transfer Count

| N1 | N0 | Bytes to Transfer |
|----|----|-------------------|
| 0  | 0  | 1                 |
| 0  | 1  | 2                 |
| 1  | 0  | 3                 |
| 1  | 1  | Streaming mode    |

Bits[A12:A0] select the address within the register map that is written to or read from during the data transfer portion of the communication cycle. Only Bits[A6:A0] are needed to cover the range of the 0x55 registers used by the AD9789. Bits[A12:A7] must always be 0. For multibyte transfers, this address is the starting byte address. In MSB first mode, subsequent bytes increment the address.

## MSB/LSB FIRST TRANSFERS

The AD9789 instruction word and byte data can be MSB first or LSB first. Any data written to Register 0x00 must be mirrored, the upper four bits (Bits[7:4]) with the lower four bits (Bits [3:0]). This makes it irrelevant whether LSB first or MSB first is in effect. As an example of this mirroring, the default setting for Register 0x00[7:0] is 0x18, which mirrors Bit 4 and Bit 3. These bits set the long instruction mode (the default and the only mode supported). The default for the AD9789 is MSB first.

When LSB first is set by Register 0x00[1] and Register 0x00[6], it takes effect immediately. In multibyte transfers, subsequent bytes reflect any changes in the serial port configuration.

When MSB first mode is active, the instruction and data bytes must be written from MSB to LSB. Multibyte data transfers in MSB first format start with an instruction byte that includes the register address of the most significant data byte. Subsequent data bytes must follow in order from the high address to the low address. In MSB first mode, the serial control port internal address generator decrements for each data byte of the multibyte transfer cycle.

When LSB first mode is active, the instruction and data bytes must be written from LSB to MSB. Multibyte data transfers in LSB first format start with an instruction byte that includes the register address of the least significant data byte followed by multiple data bytes. The internal byte address generator of the serial control port increments for each byte of the multibyte transfer cycle.

The AD9789 serial control port register address decrements from the register address just written toward 0x00 for multibyte I/O operations if the MSB first mode is active (default). If the LSB first mode is active, the register address of the serial control port increments from the address just written toward 0x55 for multibyte I/O operations.

Streaming mode always terminates when it reaches Address 0x2F. Note that unused addresses are not skipped during multibyte I/O operations.

Table 8. Streaming Mode (No Addresses Are Skipped)

| Write Mode | Address Direction | Stop Sequence             |
|------------|-------------------|---------------------------|
| LSB First  | Increment         | 0x02D, 0x02E, 0x02F, stop |
| MSB First  | Decrement         | 0x001, 0x000, 0x02F, stop |

Table 9. Serial Control Port, 16-Bit Instruction Word, MSB First

| MSB |     |     |     |     |     |    |    |    |    |    |    |    |    | LSB |    |
|-----|-----|-----|-----|-----|-----|----|----|----|----|----|----|----|----|-----|----|
| I15 | I14 | I13 | I12 | I11 | I10 | I9 | I8 | I7 | I6 | I5 | I4 | I3 | I2 | I1  | I0 |
| R/W | N1  | N0  | A12 | A11 | A10 | A9 | A8 | A7 | A6 | A5 | A4 | A3 | A2 | A1  | A0 |

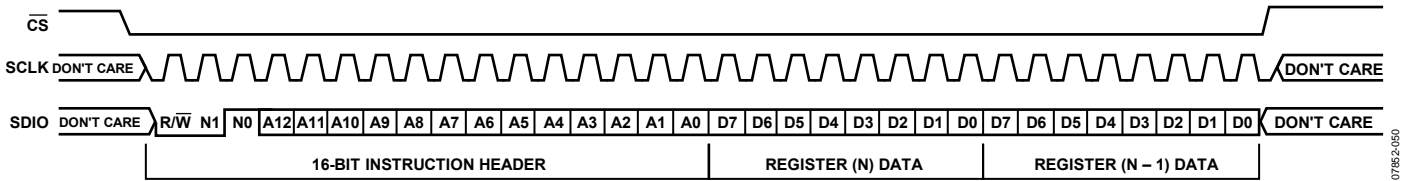

Figure 64. Serial Control Port Write—MSB First, 16-Bit Instruction, Two Bytes of Data

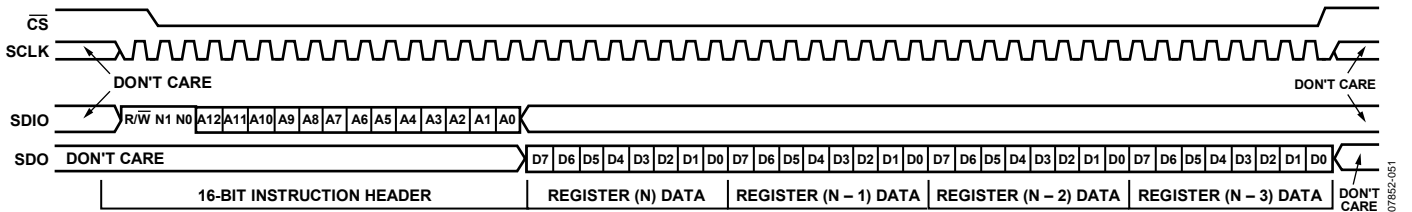

Figure 65. Serial Control Port Read—MSB First, 16-Bit Instruction, Four Bytes of Data

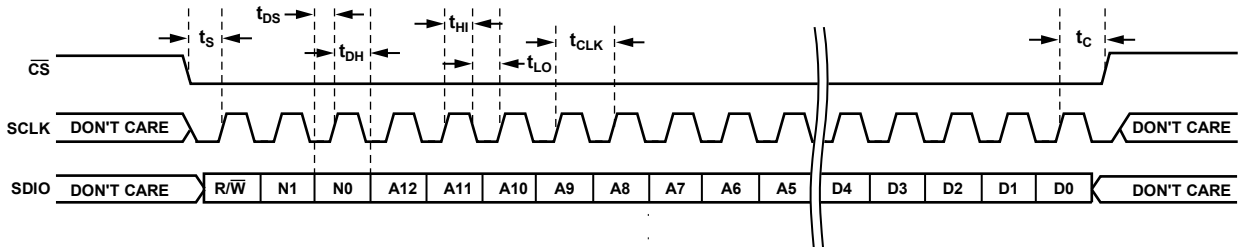

Figure 66. Serial Control Port Write—MSB First, 16-Bit Instruction, Timing Measurements

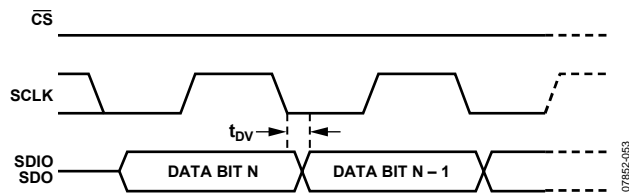

Figure 67. Timing Diagram for Serial Control Port Register Read

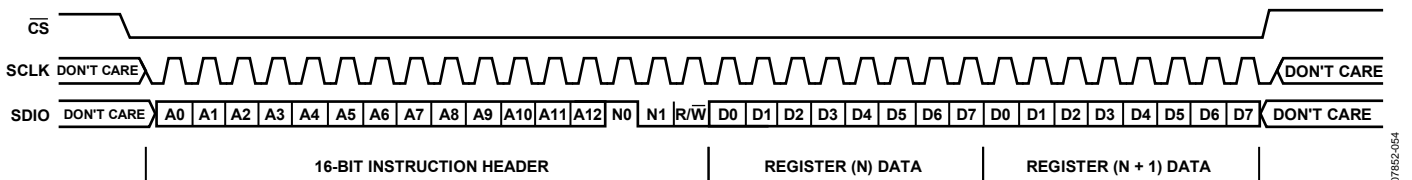

Figure 68. Serial Control Port Write—LSB First, 16-Bit Instruction, Two Bytes of Data

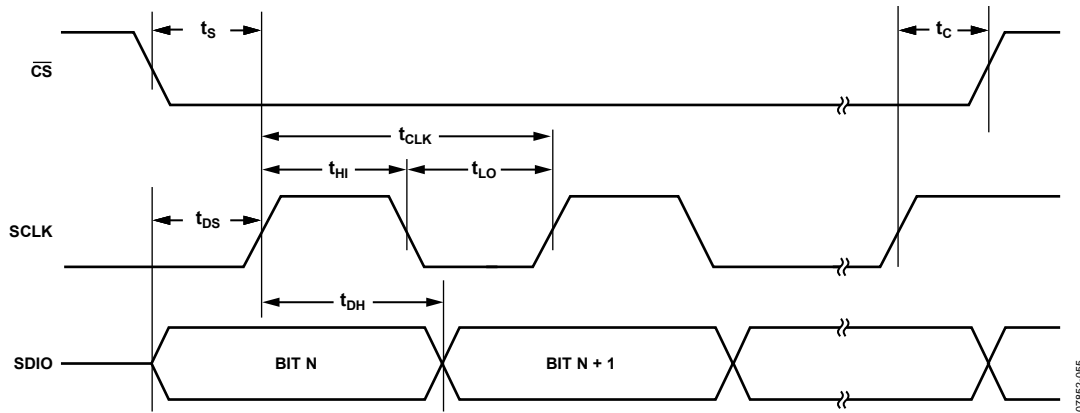

Figure 69. Serial Control Port Timing—Write

**Table 10. Serial Control Port Timing**

| Parameter | Description   |
|-----------|---|
| $t_{DS}$  | Setup time between data and rising edge of SCLK   |
| $t_{DH}$  | Hold time between data and rising edge of SCLK  |
| $t_{CLK}$ | Period of the clock   |
| $t_s$     | Setup time between $\overline{CS}$ falling edge and SCLK rising edge (start of communication cycle) |
| $t_c$     | Setup time between SCLK rising edge and $\overline{CS}$ rising edge (end of communication cycle)    |
| $t_{HI}$  | Minimum period that SCLK should be in a logic high state  |
| $t_{LO}$  | Minimum period that SCLK should be in a logic low state   |
| $t_{DV}$  | SCLK to valid SDIO and SDO (see Figure 67)  |

## SPI REGISTER MAP

Do not write to the following registers unless instructed otherwise: Register 0x34, Register 0x35, Register 0x37, Register 0x3B, Register 0x3F, or Register 0x40 through Register 0x55.

**Table 11. Register Map**

| Addr | Register Name                      | Bit 7          | Bit 6         | Bit 5      | Bit 4    | Bit 3       | Bit 2        | Bit 1    | Bit 0    | De-<br>fault |      |
|------|------------------------------------|----------------|---------------|------------|----------|-------------|--------------|----------|----------|--------------|------|
| 0x00 | SPI control                        | SDIO_DIR       | LSBFIRST      | RESET      | LNG_INST |             |              |          |          | 0x18         |      |
| 0x01 | Saturation counter                 | SATCNT[7:0]    |               |            |          |             |              |          |          | 0x00         |      |
| 0x02 | Parity counter                     | PARCNT[7:0]    |               |            |          |             |              |          |          | 0x00         |      |
| 0x03 | Interrupt enable                   | PARERR         | BISTDONE      | PARMSET    | PARMCLR  | LOCKACQ     | LOCKLOST     | SATERR   | Reserved | 0x00         |      |
| 0x04 | Interrupt status/clear             | PARERR         | BISTDONE      | PARMSET    | PARMCLR  | LOCKACQ     | LOCKLOST     | SATERR   | Reserved | 0x00         |      |
| 0x05 | Channel enable                     | Reserved       |               |            |          | CHANEN[3:0] |              |          |          | 0x00         |      |
| 0x06 | Bypass                             | QAM            | SRRC          | Reserved   | INT[4:0] |             |              |          | 0x00     |              |      |
| 0x07 | QAM/SRRC configuration             | Reserved       |               | ALPHA[1:0] |          | Reserved    | MAPPING[2:0] |          |          | 0x01         |      |
| 0x08 | Summing node scalar                | SUMSCALE[7:0]  |               |            |          |             |              |          |          | 0x0D         |      |
| 0x09 | Input scalar                       | INSCALE[7:0]   |               |            |          |             |              |          |          | 0x20         |      |
| 0x0A | NCO 0 frequency tuning word        | FTW0[7:0]      |               |            |          |             |              |          |          | 0x00         |      |
| 0x0B |                                    | FTW0[15:8]     |               |            |          |             |              |          |          | 0x00         |      |
| 0x0C |                                    | FTW0[23:16]    |               |            |          |             |              |          |          | 0x00         |      |
| 0x0D | NCO 1 frequency tuning word        | FTW1[7:0]      |               |            |          |             |              |          |          | 0x00         |      |
| 0x0E |                                    | FTW1[15:8]     |               |            |          |             |              |          |          | 0x00         |      |
| 0x0F |                                    | FTW1[23:16]    |               |            |          |             |              |          |          | 0x00         |      |
| 0x10 | NCO 2 frequency tuning word        | FTW2[7:0]      |               |            |          |             |              |          |          | 0x00         |      |
| 0x11 |                                    | FTW2[15:8]     |               |            |          |             |              |          |          | 0x00         |      |
| 0x12 |                                    | FTW2[23:16]    |               |            |          |             |              |          |          | 0x00         |      |
| 0x13 | NCO 3 frequency tuning word        | FTW3[7:0]      |               |            |          |             |              |          |          | 0x00         |      |
| 0x14 |                                    | FTW3[15:8]     |               |            |          |             |              |          |          | 0x00         |      |
| 0x15 |                                    | FTW3[23:16]    |               |            |          |             |              |          |          | 0x00         |      |
| 0x16 | Rate converter denominator (Q)     | Q[7:0]         |               |            |          |             |              |          |          | 0x00         |      |
| 0x17 |                                    | Q[15:8]        |               |            |          |             |              |          |          | 0x00         |      |
| 0x18 |                                    | Q[23:16]       |               |            |          |             |              |          |          | 0x80         |      |
| 0x19 | Rate converter numerator (P)       | P[7:0]         |               |            |          |             |              |          |          | 0x00         |      |
| 0x1A |                                    | P[15:8]        |               |            |          |             |              |          |          | 0x00         |      |
| 0x1B |                                    | P[23:16]       |               |            |          |             |              |          |          | 0x80         |      |
| 0x1C | Interpolating BPF center frequency | FC[7:0]        |               |            |          |             |              |          |          | 0x00         |      |
| 0x1D |                                    | FC[15:8]       |               |            |          |             |              |          |          | 0x00         |      |
| 0x1E | Frequency update                   | FREQNEW        | Reserved      |            |          |             |              |          |          | 0x00         |      |
| 0x1F | Hardware version                   | Reserved       |               |            |          |             | VER[3:0]     |          |          |              | 0x03 |
| 0x20 | Interface configuration            | CMOS_BUS       | CMOS_CTRL     | Reserved   | DCO_INV  | IF_MODE     | CHANPRI      | PAR[1:0] |          | 0xC8         |      |
| 0x21 | Data control                       | BIN            | BUSWIDTH[1:0] |            | DATWIDTH | CMPLEX      | LTNCY[2:0]   |          |          | 0x61         |      |
| 0x22 | DCO frequency                      | Reserved       | DCODIV[2:0]   |            |          | ONES[3:0]   |              |          | 0x1F     |              |      |
| 0x23 | Internal clock phase adjust        | DSCPHZ[3:0]    |               |            |          | SNCPHZ[3:0] |              |          |          | 0x85         |      |
| 0x24 | Parameter update                   | PARMNEW        | Reserved      |            |          |             |              |          |          | 0x00         |      |
| 0x25 | Channel 0 gain                     | CHAN0GAIN[7:0] |               |            |          |             |              |          |          | 0x80         |      |
| 0x26 | Channel 1 gain                     | CHAN1GAIN[7:0] |               |            |          |             |              |          |          | 0x80         |      |
| 0x27 | Channel 2 gain                     | CHAN2GAIN[7:0] |               |            |          |             |              |          |          | 0x80         |      |
| 0x28 | Channel 3 gain                     | CHAN3GAIN[7:0] |               |            |          |             |              |          |          | 0x80         |      |
| 0x29 | Spectrum shaping                   | Reserved       |               |            |          |             |              |          | SPEC_INV | 0x00         |      |

# AD9789

| Addr | Register Name            | Bit 7                             | Bit 6             | Bit 5                               | Bit 4          | Bit 3             | Bit 2     | Bit 1            | Bit 0 | De-fault |
|------|--------------------------|-----------------------------------|-------------------|-------------------------------------|----------------|-------------------|-----------|------------------|-------|----------|
| 0x2F | Mu Delay Control 1       | SEARCH_TOL                        | SEARCH_ERR        | TRACK_ERR                           | GUARDBAND[4:0] |                   |           |                  |       | 0x0B     |
| 0x30 | Mu control duty cycle    | Duty cycle correct enable         | INC_DEC (Factory) | MANUAL_ADJ[5:0] (Factory test only) |                |                   |           |                  | 0x40  |          |
| 0x31 | Clock Receiver 1         | CLKN_CML[3:0]                     |                   |                                     | Reserved       |                   |           |                  |       | 0xF0     |
| 0x32 | Clock Receiver 2         | CLK_DIS                           | Reserved          | PSIGN                               | CLKP_CML[3:0]  |                   |           | NSIGN            | 0x3F  |          |
| 0x33 | Mu Delay Control 2       | MU_CLKDIS                         | SLOPE             | MODE[1:0]                           |                | MUSAMP            | GAIN[1:0] |                  | MU_EN | 0x42     |
| 0x34 | Reserved                 | Reserved                          |                   |                                     |                |                   |           |                  |       | 0x00     |
| 0x35 | Reserved                 | Reserved                          |                   |                                     |                |                   |           |                  |       | 0xCA     |
| 0x36 | DAC bias                 | PDBIAS                            | Reserved          |                                     |                |                   | MSEL[1:0] |                  |       | 0x03     |
| 0x37 | Reserved                 | Reserved                          |                   |                                     |                |                   |           |                  |       | 0x00     |
| 0x38 | DAC decoder              | Reserved                          |                   |                                     |                |                   |           | DAC decoder mode |       | 0x00     |
| 0x39 | Mu Delay Control 3       | MUDLY[0]                          | SEARCH_DIR[1:0]   |                                     | MUPHZ[4:0]     |                   |           |                  | 0x40  |          |
| 0x3A | Mu Delay Control 4       | MUDLY[8:1]                        |                   |                                     |                |                   |           |                  |       | 0x00     |
| 0x3B | Reserved                 | Reserved                          |                   |                                     |                |                   |           |                  |       | 0x00     |
| 0x3C | Full-Scale Current 1     | FSC[7:0]                          |                   |                                     |                |                   |           |                  |       | 0x00     |
| 0x3D | Full-Scale Current 2     | Reserved                          |                   |                                     |                |                   |           | FSC[9:8]         |       | 0x02     |
| 0x3E | Phase detector control   | PHZ_PD                            | Reserved          | CMP_BST                             | AUTO_CAL       | PHZ_DET_BIAS[3:0] |           |                  | 0x18  |          |
| 0x3F | Reserved                 | Reserved                          |                   |                                     |                |                   |           |                  |       | 0x00     |
| 0x40 | BIST control             | CLKSHDN                           | INPUTSEL          | Reserved                            | BENABLE        | BMODE[3:0]        |           |                  | 0x00  |          |
| 0x41 | BIST status              | BDONE                             | BSTATUS[6:0]      |                                     |                |                   |           |                  |       | 0x00     |
| 0x42 | BIST zero padding length | PADLEN[7:0]                       |                   |                                     |                |                   |           |                  |       | 0x00     |
| 0x43 |                          | PADLEN[15:8]                      |                   |                                     |                |                   |           |                  |       | 0x00     |
| 0x44 | BIST vector length       | VECTLEN[7:0]                      |                   |                                     |                |                   |           |                  |       | 0x00     |
| 0x45 |                          | VECTLEN[15:8]                     |                   |                                     |                |                   |           |                  |       | 0x00     |
| 0x46 |                          | VECTLEN[23:16]                    |                   |                                     |                |                   |           |                  |       | 0x00     |
| 0x47 | BIST clock adjust        | BCLKDIV[3:0]                      |                   |                                     |                | BCLKPHZ[3:0]      |           |                  |       | 0x00     |
| 0x48 | Sign 0 control           | SOENABL                           | SORDEN            | SOPRNG                              | SOZERO         | SONEG             | SOFNLCH   | SOSEL[1:0]       |       | 0x00     |
| 0x49 | Sign 0 clock adjust      | SOCLKDIV[3:0]                     |                   |                                     |                | SOCLKPHZ[3:0]     |           |                  |       | 0x00     |
| 0x4A | Sign 1 control           | S1ENABL                           | S1RDEN            | S1PRNG                              | S1ZERO         | S1NEG             | S1FNLCH   | S1SEL[1:0]       |       | 0x00     |
| 0x4B | Sign 1 clock adjust      | S1CLKDIV[3:0]                     |                   |                                     |                | S1CLKPHZ[3:0]     |           |                  |       | 0x00     |
| 0x4C | RegFnI0Freq              | Final Rate/Offset Control 0 [7:0] |                   |                                     |                |                   |           |                  |       | 0x00     |
| 0x4D | RegFnI1Freq              | Final Rate/Offset Control 1 [7:0] |                   |                                     |                |                   |           |                  |       | 0x00     |
| 0x50 | BIST Signature 0         | SGN0[7:0]                         |                   |                                     |                |                   |           |                  |       | 0x00     |
| 0x51 |                          | SGN0[15:8]                        |                   |                                     |                |                   |           |                  |       | 0x00     |
| 0x52 |                          | SGN0[23:16]                       |                   |                                     |                |                   |           |                  |       | 0x00     |
| 0x53 | BIST Signature 1         | SGN1[7:0]                         |                   |                                     |                |                   |           |                  |       | 0x00     |
| 0x54 |                          | SGN1[15:8]                        |                   |                                     |                |                   |           |                  |       | 0x00     |
| 0x55 |                          | SGN1[23:16]                       |                   |                                     |                |                   |           |                  |       | 0x00     |

## SPI REGISTER DESCRIPTIONS

Table 12. SPI Control Register (Address 0x00)

| Bit   | Bit Name | Description   |
|-------|----------|---|
| 7     | SDIO_DIR | This bit configures the SDIO pin as an input-only pin or as a bidirectional input/output pin. Both choices conform to the SPI standard.<br>0 = input only.<br>1 = bidirectional (input/output). |
| 6     | LSBFIRST | This bit configures the SPI interface for MSB first or LSB first mode. Both choices conform to the SPI standard.<br>0 = MSB first.<br>1 = LSB first.  |
| 5     | RESET    | When set to 1, this bit resets the part. After the part is reset, 0 is written to this bit on the next cycle.<br>0 = no reset.<br>1 = software reset.   |
| 4     | LNG_INST | This bit sets the SPI to long instruction mode; 1 is the only valid value.  |
| [3:0] |          | These bits should mirror Bits[7:4]. Bit 3 should mirror Bit 4, Bit 2 should mirror Bit 5, Bit 1 should mirror Bit 6, and Bit 0 should mirror Bit 7.   |

Table 13. Saturation Counter Register (Address 0x01)

| Bit   | Bit Name    | Description  |
|-------|-------------|--|
| [7:0] | SATCNT[7:0] | This read-only register contains the saturation counter. This register reflects the number of samples at the output of the SUMSCALE gain block that overrange the datapath and are digitally clipped. The count is cleared by writing a 1 to Register 0x04, Bit 1. |

Table 14. Parity Counter Register (Address 0x02)

| Bit   | Bit Name    | Description  |
|-------|-------------|--|
| [7:0] | PARCNT[7:0] | This read-only register contains the input data parity error counter. The count is cleared by writing a 1 to Register 0x04, Bit 7. |

Table 15. Interrupt Enable Register (Address 0x03)

| Bit | Name     | Description   |
|-----|----------|---|
| 7   | PARERR   | Setting this bit to 1 enables a PARERR flag to generate an interrupt request. Generating an interrupt request results in Interrupt Bit 7 being set in Register 0x04 and the IRQ pin going low.                                  |
| 6   | BISTDONE | Setting this bit to 1 enables a BISTDONE flag to generate an interrupt request. Generating an interrupt request results in Interrupt Bit 6 being set in Register 0x04 and the IRQ pin going low.                                |
| 5   | PARMSET  | Setting this bit to 1 enables a PARMSET flag to generate an interrupt request. Generating an interrupt request results in Interrupt Bit 5 being set in Register 0x04 and the IRQ pin going low.                                 |
| 4   | PARMCLR  | Setting this bit to 1 enables a PARMCLR flag to generate an interrupt request. Generating an interrupt request results in Interrupt Bit 4 being set in Register 0x04 and the IRQ pin going low.                                 |
| 3   | LOCKACQ  | Setting this bit to 1 enables a LOCKACQ flag to generate an interrupt request. Generating an interrupt request results in Interrupt Bit 3 being set in Register 0x04 and the IRQ pin going low.                                 |
| 2   | LOCKLOST | Setting this bit to 1 enables a LOCKLOST flag to generate an interrupt request. Generating an interrupt request results in Interrupt Bit 2 being set in Register 0x04 and the IRQ pin going low.                                |
| 1   | SATERR   | Setting this bit to 1 enables a SATERR (overflow into 16x interpolator) flag to generate an interrupt request. Generating an interrupt request results in Interrupt Bit 1 being set in Register 0x04 and the IRQ pin going low. |
| 0   | Reserved | Reserved.   |

**Table 16. Interrupt Status/Clear Register (Address 0x04)**

| Bit | Name     | Description   |
|-----|----------|---|
| 7   | PARERR   | If this bit is set to 1, one or more parity errors has occurred. Writing a 1 to this bit clears the interrupt.  |
| 6   | BISTDONE | If this bit is set to 1, the BIST has reached the terminal state. Writing a 1 to this bit clears the interrupt.                                       |
| 5   | PARMSET  | If this bit is set to 1, the parameter update register (Address 0x24) has been updated. Writing a 1 to this bit clears the interrupt.                 |
| 4   | PARMCLR  | If this bit is set to 1, the parameter update register (Address 0x24) has been cleared. Writing a 1 to this bit clears the interrupt.                 |
| 3   | LOCKACQ  | If this bit is set to 1, proper data handoff between the digital engine and the DAC core is occurring.  |
| 2   | LOCKLOST | If this bit is set to 1, proper data handoff between the digital engine and the DAC core has been lost. Writing a 1 to this bit clears the interrupt. |
| 1   | SATERR   | If this bit is set to 1, one or more saturation errors (overflow into 16x interpolator) has occurred. Writing a 1 to this bit clears the interrupt.   |
| 0   | Reserved | Reserved.   |

**Table 17. Channel Enable Register (Address 0x05)**

| Bit   | Bit Name                                     | Description   |                                  |
|-------|--|---|----------------------------------|
| [7:4] | Reserved                                     | Reserved.   |                                  |
| [3:0] | CHANEN[3:0]                                  | A Logic 1 in any bit position enables the corresponding channel; 0000 means that all channels are disabled. |                                  |
|       |  | <b>Setting</b>  | <b>Channels Enabled</b>          |
|       |  | 0000  | All channels disabled.           |
|       |  | 0001  | Channel 0 enabled.               |
|       |  | 0010  | Channel 1 enabled.               |
|       |  | 0011  | Channel 0 and Channel 1 enabled. |
|       |  | ...   | ...                              |
| 1110  | Channel 1, Channel 2, and Channel 3 enabled. |   |                                  |
| 1111  | All channels enabled.                        |   |                                  |

**Table 18. Bypass Register (Address 0x06)**

| Bit   | Bit Name                            | Description   |  |
|-------|-------------------------------------|---|--|
| 7     | QAM                                 | If this bit is set to 1, the QAM mappers are bypassed.  |  |
| 6     | SRRC                                | If this bit is set to 1, the square root raised cosine (SRRC) filters are bypassed.   |  |
| 5     | Reserved                            | Reserved.   |  |
| [4:0] | INT[4:0]                            | A Logic 1 in any bit position bypasses the corresponding interpolation filter. The preferred order for bypassing interpolation filters is to first bypass Filter 0, then Filter 1, and so on. |  |
|       |                                     | <b>Setting</b>  | <b>Interpolation Filters Bypassed</b>  |
|       |                                     | 00000   | All interpolation filters enabled.   |
|       |                                     | 00001   | Interpolation Filter 0 bypassed.   |
|       |                                     | 00010   | Interpolation Filter 1 bypassed.   |
|       |                                     | 00011   | Interpolation Filter 0 and Interpolation Filter 1 bypassed.  |
|       |                                     | ...   | ...  |
|       |                                     | 01111   | Interpolation Filter 0, Interpolation Filter 1, Interpolation Filter 2, and Interpolation Filter 3 bypassed. |
|       |                                     | ...   | ...  |
| 11111 | All interpolation filters bypassed. |   |  |

Table 19. QAM/SRRC Configuration Register (Address 0x07)

| Bit   | Bit Name     | Description                           |                     |
|-------|--------------|---------------------------------------|---------------------|
| [7:6] | Reserved     | Reserved.                             |                     |
| [5:4] | ALPHA[1:0]   | These bits set the SRRC filter alpha. |                     |
|       |              | <b>Setting</b>                        | <b>Alpha Filter</b> |
|       |              | 00                                    | 0.12                |
|       |              | 01                                    | 0.18                |
|       |              | 10                                    | 0.15                |
| 11    | 0.13         |                                       |                     |
| 3     | Reserved     | Reserved.                             |                     |
| [2:0] | MAPPING[2:0] | These bits set the QAM encoding.      |                     |
|       |              | <b>Setting</b>                        | <b>QAM Encoding</b> |
|       |              | 000                                   | DOCSIS 64-QAM       |
|       |              | 001                                   | DOCSIS 256-QAM      |
|       |              | 010                                   | DVB-C 16-QAM        |
|       |              | 011                                   | DVB-C 32-QAM        |
|       |              | 100                                   | DVB-C 64-QAM        |
|       |              | 101                                   | DVB-C 128-QAM       |
|       |              | 110                                   | DVB-C 256-QAM       |
|       |              | 111                                   | Unused              |

Table 20. Summing Node Scalar Register (Address 0x08)

| Bit   | Bit Name      | Description   |                       |
|-------|---------------|---|-----------------------|
| [7:0] | SUMSCALE[7:0] | This register sets the value of the 2.6 multiplier that is applied to the output of the channel summing node. |                       |
|       |               | <b>Setting</b>  | <b>2.6 Multiplier</b> |
|       |               | 00000000  | 0                     |
|       |               | 00000001  | 0.015625              |
|       |               | 00000010  | 0.03125               |
|       |               | ...   | ...                   |
|       |               | 00001101  | 0.203125 (default)    |
|       |               | ...   | ...                   |
|       |               | 11111110  | 3.96875               |
|       |               | 11111111  | 3.984375              |

Table 21. Input Scalar Register (Address 0x09)

| Bit   | Bit Name     | Description  |                       |
|-------|--------------|--|-----------------------|
| [7:0] | INSCALE[7:0] | This register sets the value of the 3.5 multiplier that is applied to the input data. This scaling block is in parallel with the QAM encoder block and is used when the QAM encoder block is bypassed. |                       |
|       |              | <b>Setting</b>   | <b>3.5 Multiplier</b> |
|       |              | 00000000   | 0                     |
|       |              | 00000001   | 0.03125               |
|       |              | 00000010   | 0.0625                |
|       |              | ...  | ...                   |
|       |              | 00100000   | 1 (default)           |
|       |              | ...  | ...                   |
|       |              | 11111110   | 7.9375                |
|       |              | 11111111   | 7.96875               |



# AD9789

The three NCO 0 frequency tuning word registers together compose the 24-bit frequency tuning word for NCO 0. For more information about programming these registers, see the Baseband Digital Upconverter section.

**Table 22. NCO 0 Frequency Tuning Word Registers (Address 0x0A to Address 0x0C)**

| Address | Bit Name    | Description                                  |
|---------|-------------|--|
| 0x0A    | FTW0[7:0]   | Frequency tuning word for NCO 0, Bits[7:0]   |
| 0x0B    | FTW0[15:8]  | Frequency tuning word for NCO 0, Bits[15:8]  |
| 0x0C    | FTW0[23:16] | Frequency tuning word for NCO 0, Bits[23:16] |

The three NCO 1 frequency tuning word registers together compose the 24-bit frequency tuning word for NCO 1. For more information about programming these registers, see the Baseband Digital Upconverter section.

**Table 23. NCO 1 Frequency Tuning Word Registers (Address 0x0D to Address 0x0F)**

| Address | Bit Name    | Description                                  |
|---------|-------------|--|
| 0x0D    | FTW1[7:0]   | Frequency tuning word for NCO 1, Bits[7:0]   |
| 0x0E    | FTW1[15:8]  | Frequency tuning word for NCO 1, Bits[15:8]  |
| 0x0F    | FTW1[23:16] | Frequency tuning word for NCO 1, Bits[23:16] |

The three NCO 2 frequency tuning word registers together compose the 24-bit frequency tuning word for NCO 2. For more information about programming these registers, see the Baseband Digital Upconverter section.

**Table 24. NCO 2 Frequency Tuning Word Registers (Address 0x10 to Address 0x12)**

| Address | Bit Name    | Description                                  |
|---------|-------------|--|
| 0x10    | FTW2[7:0]   | Frequency tuning word for NCO 2, Bits[7:0]   |
| 0x11    | FTW2[15:8]  | Frequency tuning word for NCO 2, Bits[15:8]  |
| 0x12    | FTW2[23:16] | Frequency tuning word for NCO 2, Bits[23:16] |

The three NCO 3 frequency tuning word registers together compose the 24-bit frequency tuning word for NCO 3. For more information about programming these registers, see the Baseband Digital Upconverter section.

**Table 25. NCO 3 Frequency Tuning Word Registers (Address 0x13 to Address 0x15)**

| Address | Bit Name    | Description                                  |
|---------|-------------|--|
| 0x13    | FTW3[7:0]   | Frequency tuning word for NCO 3, Bits[7:0]   |
| 0x14    | FTW3[15:8]  | Frequency tuning word for NCO 3, Bits[15:8]  |
| 0x15    | FTW3[23:16] | Frequency tuning word for NCO 3, Bits[23:16] |

The three rate converter denominator (Q) registers together compose the 24-bit denominator for the rate converter decimation ratio. For more information about programming these registers, see the Sample Rate Converter section.

**Table 26. Rate Converter Denominator (Q) Registers (Address 0x16 to Address 0x18)**

| Address | Bit Name | Description                             |
|---------|----------|---|
| 0x16    | Q[7:0]   | Rate converter denominator, Bits[7:0]   |
| 0x17    | Q[15:8]  | Rate converter denominator, Bits[15:8]  |
| 0x18    | Q[23:16] | Rate converter denominator, Bits[23:16] |

The three rate converter numerator (P) registers together compose the 24-bit numerator for the rate converter decimation ratio. For more information about programming these registers, see the Sample Rate Converter section.

**Table 27. Rate Converter Numerator (P) Registers (Address 0x19 to Address 0x1B)**

| Address | Bit Name | Description                           |
|---------|----------|---------------------------------------|
| 0x19    | P[7:0]   | Rate converter numerator, Bits[7:0]   |
| 0x1A    | P[15:8]  | Rate converter numerator, Bits[15:8]  |
| 0x1B    | P[23:16] | Rate converter numerator, Bits[23:16] |

The two interpolating BPF center frequency registers together compose the 16-bit center frequency of the 16× band-pass interpolation filter. For more information about programming these registers, see the Digital 16× Tunable Band-Pass Filter section.

**Table 28. Interpolating BPF Center Frequency Registers (Address 0x1C and Address 0x1D)**

| Address | Bit Name | Description                  |
|---------|----------|------------------------------|
| 0x1C    | FC[7:0]  | Center frequency, Bits[7:0]  |
| 0x1D    | FC[15:8] | Center frequency, Bits[15:8] |

**Table 29. Frequency Update Register (Address 0x1E)**

| Bit   | Name     | Description  |
|-------|----------|--|
| 7     | FREQNEW  | Setting this bit to 1 updates the derived registers in the AD9789. This bit must be set for changes to Register 0x16 through Register 0x1D to take effect. This self-clearing bit is reset to 0 after the derived registers are updated. |
| [6:0] | Reserved | Reserved.  |

**Table 30. Hardware Version Register (Address 0x1F)**

| Bit   | Name     | Description   |
|-------|----------|---|
| [7:4] | Reserved | Reserved.   |
| [3:0] | VER[3:0] | This read-only register indicates the version of the chip (0011). |

**Table 31. Interface Configuration Register (Address 0x20)**

| Bit     | Bit Name  | Description   |         |                 |    |                             |    |   |    |             |    |            |
|---------|---|---|---------|-----------------|----|-----------------------------|----|---|----|-------------|----|------------|
| 7       | CMOS_BUS  | This bit reflects the state of the CMOS_BUS pin (L14).  |         |                 |    |                             |    |   |    |             |    |            |
| 6       | CMOS_CTRL   | This bit reflects the state of the CMOS_CTRL pin (M14).   |         |                 |    |                             |    |   |    |             |    |            |
| 5       | Reserved  | Reserved.   |         |                 |    |                             |    |   |    |             |    |            |
| 4       | DCO_INV   | When set to 1, the DCO pin is inverted.   |         |                 |    |                             |    |   |    |             |    |            |
| 3       | IF_MODE   | This bit sets the data interface mode.<br>0 = channelizer mode. Supports all available interface widths and 8- and 16-bit word widths. Supports maximum $f_{\text{BAUD}}$ of $f_{\text{DAC}}/48$ .<br>1 = quadrature digital upconverter (QDUC) mode. Supports 32-bit interface, 16-bit word mode only. Supports maximum $f_{\text{BAUD}}$ of $f_{\text{DAC}}/16$ .                                       |         |                 |    |                             |    |   |    |             |    |            |
| 2       | CHANPRI   | This bit selects the channel prioritization value (used in channelizer mode only).<br>0 = device expects input samples only for those channels that are enabled.<br>1 = device expects data for all four channels. Data for disabled channels is expected and must be sent, but this data is discarded by the AD9789.   |         |                 |    |                             |    |   |    |             |    |            |
| [1:0]   | PAR[1:0]  | These bits set the parity checking. For more information, see the Parity section.   |         |                 |    |                             |    |   |    |             |    |            |
|         |   | <table border="1"> <thead> <tr> <th>Setting</th> <th>Parity Checking</th> </tr> </thead> <tbody> <tr> <td>00</td> <td>Parity checking deactivated</td> </tr> <tr> <td>01</td> <td>IQ parity (a value of 0 is expected on the I channel and a value of 1 is expected on the Q channel)</td> </tr> <tr> <td>10</td> <td>Even parity</td> </tr> <tr> <td>11</td> <td>Odd parity</td> </tr> </tbody> </table> | Setting | Parity Checking | 00 | Parity checking deactivated | 01 | IQ parity (a value of 0 is expected on the I channel and a value of 1 is expected on the Q channel) | 10 | Even parity | 11 | Odd parity |
| Setting | Parity Checking   |   |         |                 |    |                             |    |   |    |             |    |            |
| 00      | Parity checking deactivated   |   |         |                 |    |                             |    |   |    |             |    |            |
| 01      | IQ parity (a value of 0 is expected on the I channel and a value of 1 is expected on the Q channel) |   |         |                 |    |                             |    |   |    |             |    |            |
| 10      | Even parity   |   |         |                 |    |                             |    |   |    |             |    |            |
| 11      | Odd parity  |   |         |                 |    |                             |    |   |    |             |    |            |

# AD9789

**Table 32. Data Control Register (Address 0x21)**

| Bit   | Bit Name      | Description   |   |
|-------|---------------|---|---|
| 7     | BIN           | This bit selects the coding for the device.<br>0 = twos complement coding.<br>1 = straight binary coding.   |   |
| [6:5] | BUSWIDTH[1:0] | These bits set the input data bus width for the device.   |   |
|       |               | <b>Setting</b>  | <b>Input Bus Width</b>  |
|       |               | 00  | 4 bits  |
|       |               | 01  | 8 bits  |
|       |               | 10  | 16 bits   |
|       |               | 11  | 32 bits   |
| 4     | DATWIDTH      | This bit sets the data-word width that is sent to the datapaths.<br>0 = 8-bit data-word.<br>1 = 16-bit data-word.                                   |   |
| 3     | CMPLX         | This bit configures the datapath for real or complex data.<br>0 = real data.<br>1 = complex data.   |   |
| [2:0] | LTNCY[2:0]    | These bits set the turnaround latency from the FS pulse to the internal data sampling time. For more information, see the Latency Register section. |   |
|       |               | <b>Setting</b>  | <b>Latency</b>  |
|       |               | 000   | Input data begins to be sampled at approximately the first rising edge of DCO after FS goes low.  |
|       |               | 001   | Input data begins to be sampled at approximately the second rising edge of DCO after FS goes low. |
|       |               | ...   | ...   |
|       |               | 111   | Input data begins to be sampled at approximately the eighth rising edge of DCO after FS goes low. |

**Table 33. DCO Frequency Register (Address 0x22)**

| Bit   | Bit Name    | Description   |                            |
|-------|-------------|---|----------------------------|
| 7     | Reserved    | Reserved.   |                            |
| [6:4] | DCODIV[2:0] | These bits configure the data clock output (DCO) frequency. |                            |
|       |             | <b>Setting</b>  | <b>DCO Clock Frequency</b> |
|       |             | 000   | DCO clock disabled         |
|       |             | 001   | $f_{DACCLK}/16$            |
|       |             | 010   | $f_{DACCLK}/32$            |
|       |             | 011   | Invalid                    |
|       |             | 100   | $f_{DACCLK}/64$            |
|       |             | 101   | Invalid                    |
|       |             | 11x   | Invalid                    |
| [3:0] | ONES[3:0]   | These bits always read back 1111.                           |                            |

Table 34. Internal Clock Phase Adjust Register (Address 0x23)

| Bit   | Bit Name                   | Description  |   |
|-------|----------------------------|--|---|
| [7:4] | DSCPHZ[3:0]                | The data sampling clock (DSC) is an internal clock that is used to sample the input data. This clock can occur on 1 of 16 phases to optimize the setup and hold timing of the data interface.                  |   |
|       |                            | <b>Setting</b>   | <b>Selected Phase</b>   |
|       |                            | 0000   | Earliest clock phase  |
|       |                            | 0001   | Second earliest clock phase that occurs 1/16 of a DSC cycle later |
| ...   | ...                        |  |   |
| 1111  | Last available clock phase |  |   |
| [3:0] | SNCPHZ[3:0]                | The synchronization clock (SNC) is an internal clock that is used to synchronize the digital datapath clock with the DAC clock. This clock can occur on 1 of 16 phases to optimize the DAC-to-datapath timing. |   |
|       |                            | <b>Setting</b>   | <b>Selected Phase</b>   |
|       |                            | 0000   | Earliest clock phase  |
|       |                            | 0001   | Second earliest clock phase that occurs 1/16 of a DSC cycle later |
| ...   | ...                        |  |   |
| 1111  | Last available clock phase |  |   |

Table 35. Parameter Update Register (Address 0x24)

| Bit   | Name     | Description   |
|-------|----------|---|
| 7     | PARMNEW  | This bit must transition from 0 to 1 for changes to Register 0x22 and Register 0x23 to take effect. Assuming that this bit was previously set to 0, writing a 1 to this bit causes the readback value of the bit to reflect the state of the chip. (The state of the chip is updated very quickly; for this reason, users with slow SPI implementations may never read back a 0 after an update.)<br>0 = values have not been updated.<br>1 = values have been updated. |
| [6:0] | Reserved | Reserved.   |

Table 36. Channel Gain Registers (Address 0x25 to Address 0x28)

| Address | Register Name  | Bit Name       | Description  |                     |
|---------|----------------|----------------|--|---------------------|
| 0x25    | Channel 0 gain | CHAN0GAIN[7:0] | These registers configure a value for the 1.7 multiplier applied to each individual channel just prior to the SUMSCALE block. The range of the channel gain is 0 to 1.9921875 with a step size of 0.0078125. To mute an individual channel, set the scale factor to 0. |                     |
| 0x26    | Channel 1 gain | CHAN1GAIN[7:0] |  |                     |
| 0x27    | Channel 2 gain | CHAN2GAIN[7:0] |  |                     |
| 0x28    | Channel 3 gain | CHAN3GAIN[7:0] |  |                     |
|         |                |                | <b>Setting</b>   | <b>Channel Gain</b> |
|         |                |                | 00000000   | 0                   |
|         |                |                | 00000001   | 0.0078125           |
|         |                |                | ...  | ...                 |
|         |                |                | 11111111   | 1.9921875           |

Table 37. Spectrum Shaping Register (Address 0x29)

| Bit   | Name     | Description   |
|-------|----------|---|
| [7:1] | Reserved | Reserved.   |
| 0     | SPEC_INV | Setting this bit to 1 spectrally inverts the signal, effectively multiplying the Q data by $-1$ . |

# AD9789

**Table 38. Mu Delay Control 1 Register (Address 0x2F)**

| Bit     | Bit Name       | Description  |         |            |       |   |     |     |       |              |     |     |       |    |
|---------|----------------|--|---------|------------|-------|---|-----|-----|-------|--------------|-----|-----|-------|----|
| 7       | SEARCH_TOL     | This bit specifies the accuracy of the phase search. The optimal value for this bit is 1.<br>0 = not exact: the search can find a phase within two values of the desired phase.<br>1 = exact: the search finds the exact phase specified.  |         |            |       |   |     |     |       |              |     |     |       |    |
| 6       | SEARCH_ERR     | This bit configures the search behavior when an error is encountered.<br>0 = stop on error.<br>1 = retry on error.   |         |            |       |   |     |     |       |              |     |     |       |    |
| 5       | TRACK_ERR      | This bit configures the track behavior if the controller does not find the desired phase. The optimal value for this bit is 0.<br>0 = continue on error.<br>1 = reset on error.  |         |            |       |   |     |     |       |              |     |     |       |    |
| [4:0]   | GUARDBAND[4:0] | <p>These bits set the guard band value. The guard band is defined as follows:<br/> <math>GUARDBAND[4:0] \times 8 = \text{number of mu delay codes of guard band from the endpoints}</math><br/>           If the search mode is alternating, the search proceeds in both directions until the guard band is reached in one direction. When the guard band is reached, the search continues only in the opposite direction. If the desired phase is not found before the guard band is reached in the second direction, the search reverts to the alternating mode and continues looking within the guard band. The search fails if the mu delay reaches the endpoints. For more information, see the Mu Delay Controller section.</p> <table border="1"> <thead> <tr> <th>Setting</th> <th>Guard Band</th> </tr> </thead> <tbody> <tr> <td>00000</td> <td>0</td> </tr> <tr> <td>...</td> <td>...</td> </tr> <tr> <td>01011</td> <td>11 (default)</td> </tr> <tr> <td>...</td> <td>...</td> </tr> <tr> <td>11111</td> <td>31</td> </tr> </tbody> </table> | Setting | Guard Band | 00000 | 0 | ... | ... | 01011 | 11 (default) | ... | ... | 11111 | 31 |
| Setting | Guard Band     |  |         |            |       |   |     |     |       |              |     |     |       |    |
| 00000   | 0              |  |         |            |       |   |     |     |       |              |     |     |       |    |
| ...     | ...            |  |         |            |       |   |     |     |       |              |     |     |       |    |
| 01011   | 11 (default)   |  |         |            |       |   |     |     |       |              |     |     |       |    |
| ...     | ...            |  |         |            |       |   |     |     |       |              |     |     |       |    |
| 11111   | 31             |  |         |            |       |   |     |     |       |              |     |     |       |    |

**Table 39. Mu Control Duty Cycle Register (Address 0x30)**

| Bit   | Bit Name                  | Description   |
|-------|---------------------------|---|
| 7     | Duty cycle correct enable | Setting this bit to 1 turns on the mu control duty cycle correction circuitry. Turn on this function before enabling the mu controller. Along with the phase comparator boost (enabled in Register 0x3E[5]), this function allows for more robust operation of the mu controller over the entire operating speed of the part. |
| 6     | INC_DEC                   | Reserved (factory use only).  |
| [5:0] | MANUAL_ADJ[5:0]           | Reserved (factory use only).  |

**Table 40. Clock Receiver 1 Register (Address 0x31)**

| Bit   | Bit Name      | Description  |
|-------|---------------|--|
| [7:4] | CLKN_CML[3:0] | These bits adjust the common-mode level at the CLKN pin. The recommended value for these bits and the CLKP_CML[3:0] bits is 0xF. For more information, see the Optimizing the Clock Common-Mode Voltage section. |
| [3:0] | Reserved      | Reserved.  |

**Table 41. Clock Receiver 2 Register (Address 0x32)**

| Bit   | Bit Name      | Description  |
|-------|---------------|--|
| 7     | CLK_DIS       | This bit disables or enables the clock receiver. When the AD9789 powers up, this bit is set to 0 to prevent severe output noise that occurs on power-up with no clock. When the DAC clock is stable, set this bit to 1.<br>0 = disabled.<br>1 = enabled. |
| 6     | Reserved      | Reserved (factory use only; leave at default value).   |
| 5     | PSIGN         | This bit specifies the sign for the CLKP_CML bits.<br>0 = negative (recommended).<br>1 = positive.   |
| [4:1] | CLKP_CML[3:0] | These bits adjust the common-mode level at the CLKP pin. The recommended value for these bits and the CLKN_CML[3:0] bits is 0xF. For more information, see the Optimizing the Clock Common-Mode Voltage section.   |
| 0     | NSIGN         | This bit specifies the sign for the CLKN_CML bits.<br>0 = negative (recommended).<br>1 = positive.   |

Table 42. Mu Delay Control 2 Register (Address 0x33)

| Bit   | Bit Name  | Description   |
|-------|-----------|---|
| 7     | MU_CLKDIS | This bit disables or enables the clock to the mu delay controller.<br>0 = enabled.<br>1 = disabled.   |
| 6     | SLOPE     | This bit configures the desired slope for the phase measurement of the mu delay. When the desired phase is measured, the slope of the phase measurement is calculated and compared to the value of this bit. For optimal ac performance, the best setting for the search is a positive slope and a phase value of 14.<br>0 = negative.<br>1 = positive.   |
| [5:4] | MODE[1:0] | These bits configure the mode of operation for the mu controller.<br>00 = search and track (recommended).<br>01 = track only.<br>10 = search only.<br>11 = invalid.   |
| 3     | MUSAMP    | Transitioning this bit from 0 to 1 enables the user to read back the mu delay value that the controller locked to (the MUDLY bits in Register 0x39 and Register 0x3A), as well as the phase that it locked to (the MUPHZ bits in Register 0x39).<br>0 = no action.<br>1 = transition from 0 to 1 captures the readback of the mu controller phase and delay.  |
| [2:1] | GAIN[1:0] | These bits set the tracking rate of the mu controller.<br>00 = slowest tracking.<br>01 = nominal tracking (recommended).<br>10 = fastest tracking.<br>11 = invalid (do not use).  |
| 0     | MU_EN     | This bit enables or disables the mu controller. Before enabling the mu controller, turn on both the phase comparator boost (Register 0x3E[5]) and the mu control duty cycle correction circuitry (Register 0x30[7]). Both of these functions allow for more robust operation of the mu controller over the entire operating speed of the part.<br>0 = mu controller off (manual mode).<br>1 = mu controller on (auto mode). |

Table 43. DAC Bias Register (Address 0x36)

| Bit   | Bit Name  | Description   |
|-------|-----------|---|
| 7     | PDBIAS    | Setting this bit to 1 powers down the DAC circuitry.  |
| [6:2] | Reserved  | Reserved.   |
| [1:0] | MSEL[1:0] | These bits set the mirror roll-off frequency control, which can be used to adjust the noise contribution of the internal current mirror to optimize the 1/f noise.<br>00 = bypass the mirror roll-off frequency control.<br>01 = narrowest bandwidth.<br>10 = medium bandwidth.<br>11 = widest bandwidth. |

Table 44. DAC Decoder Register (Address 0x38)

| Bit   | Bit Name         | Description   |
|-------|------------------|---|
| [7:2] | Reserved         | Reserved.   |
| [1:0] | DAC decoder mode | These bits set the decoder mode for the DAC. It is recommended that normal mode (the default) be used.<br>00 = normal mode.<br>01 = return to zero mode.<br>10 = mix mode.<br>11 = invalid. |

# AD9789

**Table 45. Mu Delay Control 3 Register (Address 0x39)**

| Bit   | Bit Name        | Description  |
|-------|-----------------|--|
| 7     | MUDLY[0]        | This bit is the LSB of the mu delay value. Along with Bits[7:0] in Register 0x3A, this bit configures the programmable mu delay; the search algorithm begins at this specified mu delay value. In manual mode, the MUDLY bits can be written to. In tracking mode, the sampled MUDLY value can be read back. Even though there are 9 bits of resolution for this delay line value, the maximum allowable mu delay is 431 (0x1AF). The optimal point to begin the search is in the middle of the delay line, or approximately 216 (0xD8). |
| [6:5] | SEARCH_DIR[1:0] | These bits configure the search direction, starting at the selected mu delay value.<br>00 = search down.<br>01 = search up.<br>10 = search up and down (optimal).<br>11 = invalid.   |
| [4:0] | MUPHZ[4:0]      | These bits specify the phase to be measured with the maximum allowable phase being 16 (10000). If a value larger than 16 is loaded, the controller will not lock. When the desired phase is measured, the slope of the phase measurement is calculated and compared to the configured slope, which is specified by the SLOPE bit in Register 0x33[6]. For optimal ac performance, the best setting for the search is for a positive slope and a phase value of 14 (01110).   |

**Table 46. Mu Delay Control 4 Register (Address 0x3A)**

| Bit   | Bit Name   | Description  |
|-------|------------|--|
| [7:0] | MUDLY[8:1] | Along with Bit 7 in Register 0x39, these bits configure the programmable mu delay; the search algorithm begins at this specified mu delay value. In manual mode, the MUDLY bits can be written to. In tracking mode, the sampled MUDLY value can be read back. Even though there are 9 bits of resolution for this delay line value, the maximum allowable mu delay is 431 (0x1AF). The optimal point to begin the search is in the middle of the delay line, or approximately 216 (0xD8). |

**Table 47. Full-Scale Current 1 Register (Address 0x3C)**

| Bit                                   | Bit Name                | Description  |                                       |                         |           |     |     |     |           |              |     |     |           |    |     |     |           |      |
|---------------------------------------|-------------------------|--|---------------------------------------|-------------------------|-----------|-----|-----|-----|-----------|--------------|-----|-----|-----------|----|-----|-----|-----------|------|
| [7:0]                                 | FSC[7:0]                | Along with Bits[1:0] in Register 0x3D, this register sets the full-scale current for the DAC. For more information, see the Voltage Reference section.   |                                       |                         |           |     |     |     |           |              |     |     |           |    |     |     |           |      |
|                                       |                         | <table border="1"> <thead> <tr> <th>Setting (Includes Register 0x3D[1:0])</th> <th>Full-Scale Current (mA)</th> </tr> </thead> <tbody> <tr> <td>000000000</td> <td>8.6</td> </tr> <tr> <td>...</td> <td>...</td> </tr> <tr> <td>100000000</td> <td>20 (default)</td> </tr> <tr> <td>...</td> <td>...</td> </tr> <tr> <td>101101000</td> <td>25</td> </tr> <tr> <td>...</td> <td>...</td> </tr> <tr> <td>111111111</td> <td>32.1</td> </tr> </tbody> </table> | Setting (Includes Register 0x3D[1:0]) | Full-Scale Current (mA) | 000000000 | 8.6 | ... | ... | 100000000 | 20 (default) | ... | ... | 101101000 | 25 | ... | ... | 111111111 | 32.1 |
| Setting (Includes Register 0x3D[1:0]) | Full-Scale Current (mA) |  |                                       |                         |           |     |     |     |           |              |     |     |           |    |     |     |           |      |
| 000000000                             | 8.6                     |  |                                       |                         |           |     |     |     |           |              |     |     |           |    |     |     |           |      |
| ...                                   | ...                     |  |                                       |                         |           |     |     |     |           |              |     |     |           |    |     |     |           |      |
| 100000000                             | 20 (default)            |  |                                       |                         |           |     |     |     |           |              |     |     |           |    |     |     |           |      |
| ...                                   | ...                     |  |                                       |                         |           |     |     |     |           |              |     |     |           |    |     |     |           |      |
| 101101000                             | 25                      |  |                                       |                         |           |     |     |     |           |              |     |     |           |    |     |     |           |      |
| ...                                   | ...                     |  |                                       |                         |           |     |     |     |           |              |     |     |           |    |     |     |           |      |
| 111111111                             | 32.1                    |  |                                       |                         |           |     |     |     |           |              |     |     |           |    |     |     |           |      |

**Table 48. Full-Scale Current 2 Register (Address 0x3D)**

| Bit   | Bit Name | Description   |
|-------|----------|---|
| [7:2] | Reserved | Reserved.   |
| [1:0] | FSC[9:8] | Along with the FSC[7:0] bits in Register 0x3C, these bits set the full-scale current for the DAC. For more information, see Table 47 and the Voltage Reference section. |

**Table 49. Phase Detector Control Register (Address 0x3E)**

| Bit   | Bit Name          | Description  |
|-------|-------------------|--|
| 7     | PHZ_PD            | Powers down the phase detector. This bit is for factory use only; this bit should be set to 0. |
| 6     | Reserved          | Reserved.  |
| 5     | CMP_BST           | Comparator boost. This bit is for factory use only; this bit should always be set to 1.        |
| 4     | AUTO_CAL          | This bit is for factory use only; this bit should always be set to 1.                          |
| [3:0] | PHZ_DET_BIAS[3:0] | These bits display the binary weighted current. Do not write to these bits (factory use only). |

## THEORY OF OPERATION

The AD9789 is a flexible digital signal processing (DSP) engine combined with a high performance, 2400 MSPS, 14-bit DAC (Figure 70). The DSP blocks include a QAM encoder, a 2× upsampling square root raised cosine (SRRC) filter, selectable interpolation from 16× to 512×, a rate converter, and a complex modulator. The digital interface can accept up to four channels of complex data. The QAM encoder supports constellation sizes of 16, 32, 64, 128, and 256. The on-chip rate converter allows fine resolution of baud rates with a fixed DAC sampling clock. The digital upconverters can place the input signals from dc to  $0.5 \times f_{DAC}$ . An analog mix mode extends the output spectrum into the second and third DAC Nyquist zones.

Control of the AD9789 functions is via a serial peripheral interface (SPI).

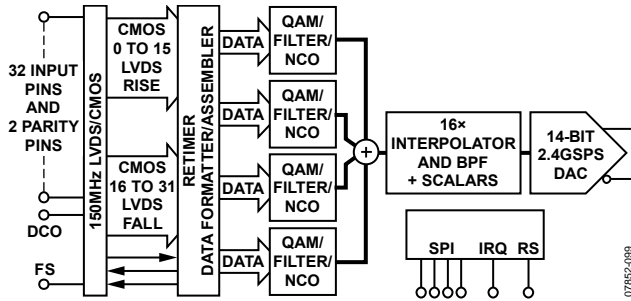

Figure 70. Top Level Functional Block Diagram

## DATAPATH SIGNAL PROCESSING

The DSP blocks included on the AD9789 can be grouped into two sections. The first is the datapath signal processing. Four identical datapaths, or channels, can be used. A block diagram of a single channel is shown in Figure 71. Enabling and disabling each DSP block within the datapath takes effect on all channels. There is independent control of the scaling and the frequency placement of each channel.

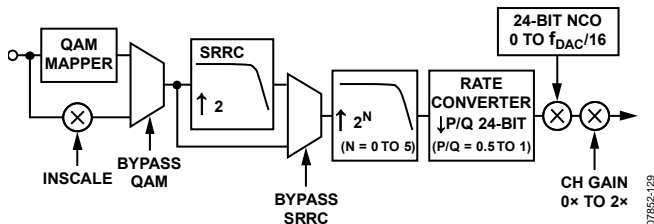

Figure 71. Datapath Block Diagram

The following sections describe each of the DSP blocks included in the datapath.

## QAM Encoder

The QAM encoder supports seven different standards-compliant mappings. (For illustrations of the supported mappings, see the QAM Constellation Maps section.) The QAM encoder receives input data-words of 8 bits in width and maps them into 16, 32, 64, 128, or 256 point constellations. It outputs 5-bit complex QAM modulated samples. The mode in which the QAM encoder runs is selected via the QAM/SRRC configuration register (Register 0x07[2:0]).

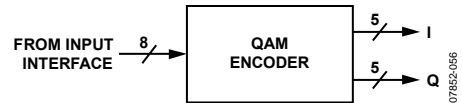

Figure 72. QAM Encoder I/O

Table 50 lists the available QAM mapper modes along with the corresponding input bits and output range. The operation of the QAM encoder when configured in DOCSIS 64-QAM mode is described in this section. The operation of the QAM encoder in the other modes is conceptually the same; only the input data bit encoding and scale factors are different.

The DOCSIS 64-QAM constellation diagram is shown in Figure 73. The constellation diagram shows how the QAM encoder input is mapped into the QAM constellation. For example, an input data-word of 111111 maps to the constellation point in the upper right corner of the 64-QAM constellation.

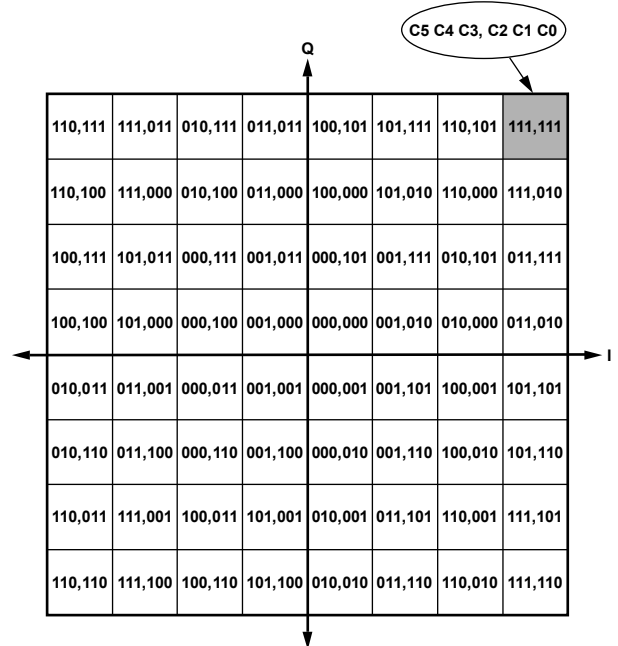

Figure 73. DOCSIS 64-QAM Constellation



**Table 50. QAM Mapper Input and Output Range vs. Mode**

| ITU-T J.83 Annex | Description    | SPI Register 0x07, MAPPING[2:0] Bits | Bit Range at Output | Input Bits B7 B6 B5 B4 B3 B2 B1 B0 <sup>1</sup> |
|------------------|----------------|--------------------------------------|---------------------|---|
| B                | DOCSIS 64-QAM  | 000                                  | -14 to +14          | X X C5 C4 C3 C2 C1 C0                           |
| B                | DOCSIS 256-QAM | 001                                  | -15 to +15          | C7 C6 C5 C4 C3 C2 C1 C0                         |
| A                | DVB-C 16-QAM   | 010                                  | -15 to +15          | X X X X C3 C2 C1 C0                             |
| A                | DVB-C 32-QAM   | 011                                  | -15 to +15          | X X X C4 C3 C2 C1 C0                            |
| A and C          | DVB-C 64-QAM   | 100                                  | -14 to +14          | X X C5 C4 C3 C2 C1 C0                           |
| A and C          | DVB-C 128-QAM  | 101                                  | -11 to +11          | X C6 C5 C4 C3 C2 C1 C0                          |
| A and C          | DVB-C 256-QAM  | 110                                  | -15 to +15          | C7 C6 C5 C4 C3 C2 C1 C0                         |
|                  | Unused         | 111                                  |                     |   |

<sup>1</sup> X = don't care.

Each constellation point corresponds to an I and Q coordinate pair, as shown in Figure 74. In the figure, two symbols are highlighted in a 64-QAM constellation: I = 14, Q = 14 (Pair 1) and I = 6, Q = -10 (Pair 2).

To represent the I and Q coordinate points, 5-bit, twos complement numbers are used. For example, an input of 011101 into the QAM encoder maps to the I = 6, Q = -10 position of the QAM-64 constellation and results in output samples of I = 00110, Q = 10110.

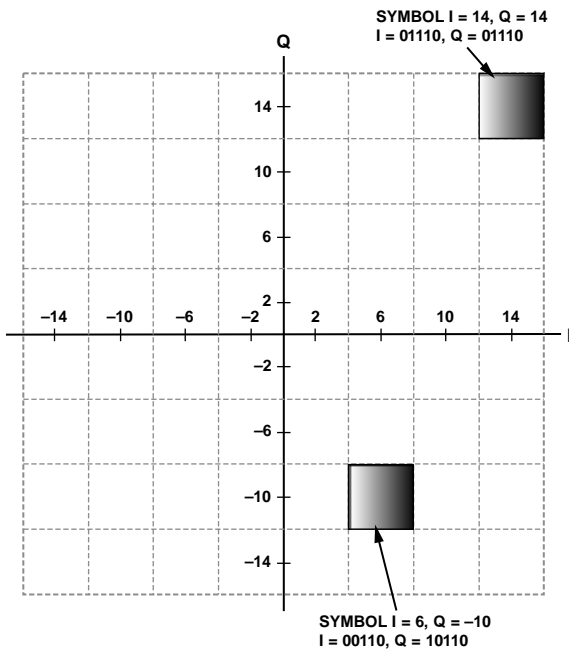

Figure 74. I and Q Symbol Mapping

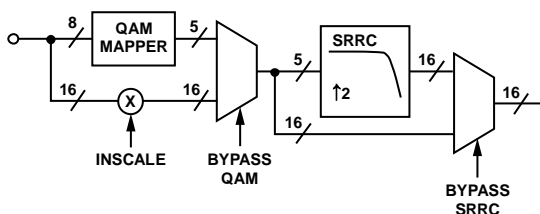

Figure 75. QAM Mapper and SRRC Filter Detail (I and Q Paths Are Identical So Only One Is Shown)

### Input Scalar

The input scalar block is active only when the QAM mapper is bypassed. The value of INSCALE[7:0] is programmed in Register 0x09[7:0]. The scale factor applied to the input data is calculated as follows:

$$ScaleFactor = \frac{INSCALE[7:0]}{32}$$

This factor provides a scaling range of the input data from 0 to 7.96875 in steps of 0.03125. The default value of 0x20 provides a scale factor of 1. As shown in Figure 76, the output of the input scalar block is rounded to the nearest 16-bit value. If the output exceeds the maximum or minimum value, it is clipped to either positive or negative full scale (0x7FFF or 0x8000).

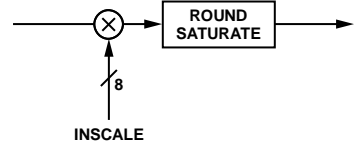

Figure 76. Input Scalar Block Diagram

### SRRC Filter

The square root raised cosine (SRRC) filter performs a 2x interpolation and filtering operation on the input data. The SRRC filter has a pass band, transition band, and stop band requirement as per the DOCSIS, Euro-DOCSIS, and DVB-C standards.

To cover all the standards, the value of alpha can be set to 0.12, 0.13, 0.15, or 0.18. This value is programmed in Register 0x07[5:4]. The frequency,  $f_N$ , is determined by the input data baud rate. The response of the SRRC filter is illustrated in Figure 77.

The SRRC filter accepts only five bits at its input and can be bypassed (Register 0x06[6]). If the SRRC filter is the first block enabled in the datapath, these five bits are the five MSBs of the 8-bit data-word.

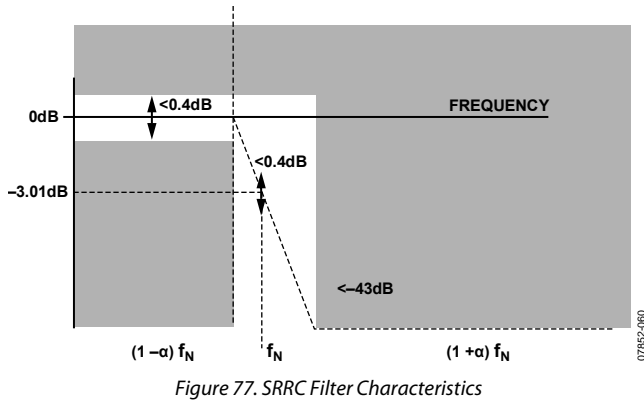

Figure 77. SRRC Filter Characteristics

If the SRRC filter is used, at least four of the  $2\times$  interpolation filters must be enabled. The reason for this is that the SRRC filter requires a minimum of 12 clock cycles at the  $f_{DAC}/16$  rate per sample to function properly.

**Half-Band Interpolation Filters**

The AD9789 can provide from  $1\times$  to  $32\times$  interpolation through the datapath using five bypassable half-band interpolation filters. The half-band interpolation filters are controlled via Register 0x06[4:0]. The preferred order in terms of power savings for bypassing these filters is to bypass Filter 0 first, then Filter 1, and so on. The frequency response of the low-pass filters is shown in Figure 79 through Figure 82. All of the filters have a pass band of  $0.8 \times f_{INPUT}$ , where  $f_{INPUT}$  is the data rate at the input of each filter. The pass band is flat to within 0.01 dB for all filters. The stop-band attenuation exceeds 85 dB in Filter 0, Filter 1, and Filter 2, and 75 dB in Filter 3 and Filter 4.

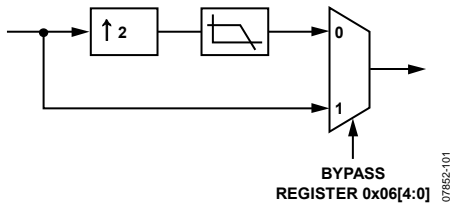

Figure 78. Conceptual Block Diagram of  $2\times$  Half-Band Interpolation Filters

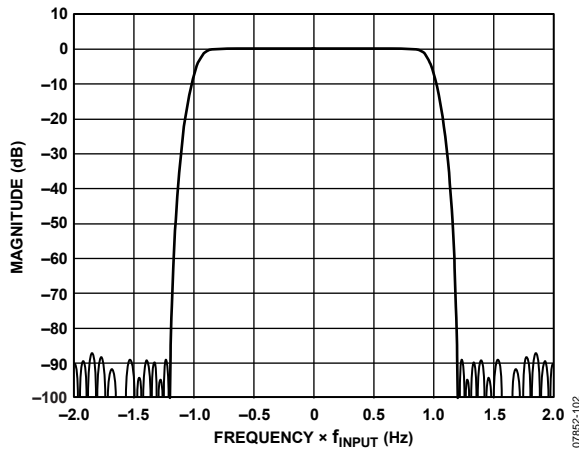

Figure 79.  $2\times$  Half-Band Interpolation Filter 0 Response

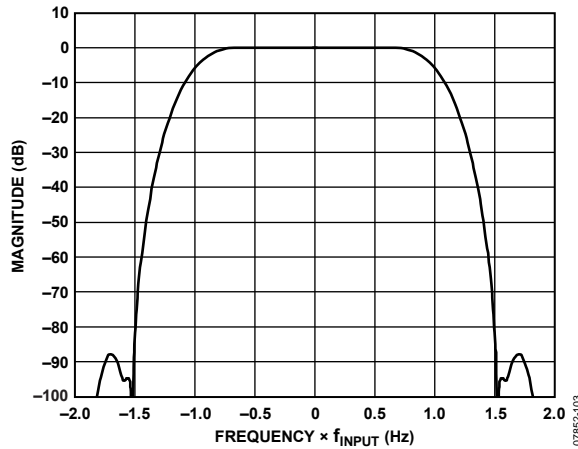

Figure 80.  $2\times$  Half-Band Interpolation Filter 1 Response

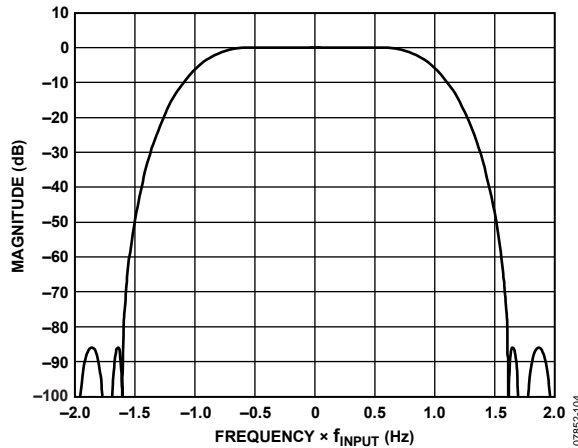

Figure 81.  $2\times$  Half-Band Interpolation Filter 2 Response

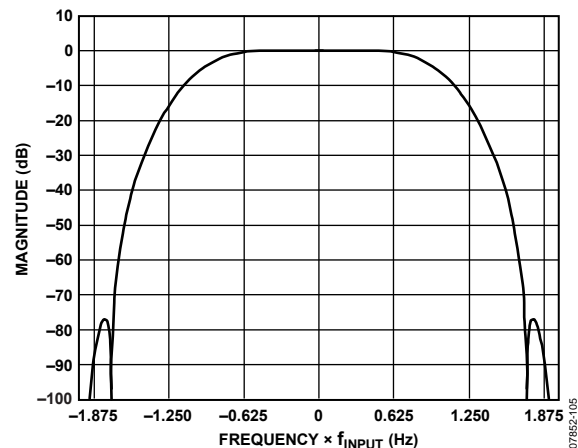

Figure 82.  $2\times$  Half-Band Interpolation Filter 3 and Filter 4 Response

## Sample Rate Converter

The purpose of the sample rate converter (SRC) is to provide increased flexibility in the ratio of the input baud rate to the DAC update rate. Each of the four channelization datapaths contains a sample rate converter (SRC) that provides a data rate conversion in the range of 0.5 to 1.0 inclusive. The rate conversion factor is set by the ratio of two 24-bit values, P and Q. Figure 83 is a conceptual block diagram of the SRC. It can be thought of as an interpolation block, followed by filtering and decimation blocks.

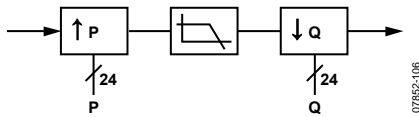

Figure 83. Conceptual Block Diagram of the Sample Rate Converter

The values of P and Q are set by programming the P[23:0] and Q[23:0] registers at Address 0x16 through Address 0x1B.

**Table 51. Register Locations for Sample Rate Converter**

| Bits             | Numerator (P) | Denominator (Q) |
|------------------|---------------|-----------------|
| [23:16] (Byte 2) | Register 0x1B | Register 0x18   |
| [15:8] (Byte 1)  | Register 0x1A | Register 0x17   |
| [7:0] (Byte 0)   | Register 0x19 | Register 0x16   |

The values of P and Q should be selected to satisfy the following equation for the desired baud rate ( $f_{BAUD}$ ) and DAC clock frequency ( $f_{DAC}$ ).

$$f_{DAC} = I \times \frac{P}{Q} \times 16 \times f_{BAUD} \quad (1)$$

where  $I$  is the total interpolation ratio of the SRRC filter and the five half-band interpolation filters.

If Equation 1 is satisfied, the long-term baud rate,  $f_{BAUD}$ , is exactly maintained. No residual frequency offset errors are introduced by the rate conversion process.

The values of P and Q must be selected within the following constraints:

$$0.5 \leq \frac{P}{Q} \leq 1.0 \quad (2)$$

$$Q[23] = 1 \quad (3)$$

Equation 3 states that the value of Q must be shifted so that the MSB of Q is set.

In most systems, the baud rate is a given, and the DAC sample rate is selected so that it is high enough to support the signal bandwidth and output frequency requirements. In many cases, it is desirable to set the DAC clock rate to a multiple of a system clock rate. The following example shows how P and Q can be selected in such a system.

## Example

A DOCSIS application has a master system clock that runs at a frequency of  $f_{MASTER}$ . Several channel baud rates are supported, all of which are fractions of the master clock and can be represented by the following equation:

$$f_{BAUD} = \frac{M}{N} \times f_{MASTER} \quad (4)$$

Equation 1 must be satisfied for  $f_{BAUD}$  to be exactly maintained. To facilitate this, the DAC sampling frequency is selected to be a multiple of  $f_{MASTER}$  that satisfies the signal bandwidth and output frequency requirements. For  $f_{MASTER} = 10.24$  MHz, a signal bandwidth requirement of 32 MHz or greater, and a supported output frequency band of up to 1 GHz, the following DAC sampling frequency can be selected:

$$f_{DAC} = 224 \times f_{MASTER} = 2293.76 \text{ MHz} \quad (5)$$

Inserting Equation 4 and Equation 5 into Equation 1 results in Equation 6.

$$224 \times f_{MASTER} = I \times \frac{P}{Q} \times 16 \times \frac{M}{N} \times f_{MASTER} \quad (6)$$

Enabling the SRRC filter and four of the half-band interpolation filters would result in the total interpolation factor,  $I$ , being equal to 32. Substituting 32 for  $I$  and simplifying Equation 6 results in Equation 7.

$$\frac{P}{Q} = \frac{N}{M} \times \frac{7}{16} \quad (7)$$

Recall that  $N$  and  $M$  are given by the required baud rate. For example, assume a baud rate of 5.0569 MHz, which results from  $M = 401$  and  $N = 812$ .

$$f_{BAUD} = \frac{401}{812} \times 10.24 \text{ MHz} = 5.0569 \text{ MHz} \quad (8)$$

P and Q can then be calculated from the numerator and denominator of Equation 9.

$$\frac{P}{Q} = \frac{812}{401} \times \frac{7}{16} = \frac{5684}{6416} = \frac{0x1634}{0x1910} \quad (9)$$

Because the value of Q must be MSB justified, both numbers can be shifted by 11 bits, resulting in the final P and Q values of 0xB1A000 and 0xC80000, respectively.

## Baseband Digital Upconverter

The digital upconverter enables each baseband channel to be placed anywhere from dc to  $f_{DAC}/16$ . The center frequency for each of the four channels is register programmable through the 24-bit frequency tuning words, FTW 0 through FTW 3. For the desired center frequency of each individual channel, the FTW can be calculated as follows:

$$FTW = \frac{f_{CENTER}}{\left(\frac{f_{DAC}}{16}\right)} \times (2^{24} - 1)$$

The calculated FTW for each channel should be entered into the register locations listed in Table 52.

**Table 52. Register Locations of FTWs for Each Channel**

| FTW     | Channel 0 | Channel 1 | Channel 2 | Channel 3 |
|---------|-----------|-----------|-----------|-----------|
| [23:16] | Reg. 0x0C | Reg. 0x0F | Reg. 0x12 | Reg. 0x15 |
| [15:8]  | Reg. 0x0B | Reg. 0x0E | Reg. 0x11 | Reg. 0x14 |
| [7:0]   | Reg 0x0A  | Reg 0x0D  | Reg 0x10  | Reg 0x13  |

The FTW sets the frequency of the sine and cosine signals generated by the numerically controlled oscillator (NCO). The complex output from the NCO is multiplied by the input datapath signal to modulate the signal to the desired output frequency. A conceptual block diagram of the baseband digital upconverter is shown in Figure 84.

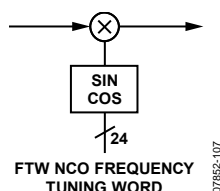

Figure 84. Conceptual Block Diagram of the Baseband Digital Upconverter

**Individual Channel Scalar**

The last block in the datapath is an 8-bit scalar (Register 0x25 Register 0x28) intended for compensating out any sampling and hardware roll-offs that may be encountered. The scale factor applied to each channel is calculated as follows:

$$ScaleFactor = \frac{CHANxGAIN[7:0]}{128}$$

The range of the channel gain is 0 to 1.9921875 with a step size of 0.0078125. An individual channel can be easily and quickly muted, if desired, by setting the scale factor to 0.

**Table 53. Register Locations for Channel Gain Scalar**

| CHANxGAIN | Channel 0 | Channel 1 | Channel 2 | Channel 3 |
|-----------|-----------|-----------|-----------|-----------|
| [7:0]     | Reg. 0x25 | Reg. 0x26 | Reg. 0x27 | Reg. 0x28 |

The default value of the channel gain provides a scale factor of 1. As shown in Figure 85, the output of the input scalar block is rounded to the nearest 16-bit value. If the output exceeds the maximum or minimum value, it is clipped to either positive or negative full scale (0x7FFF or 0x8000).

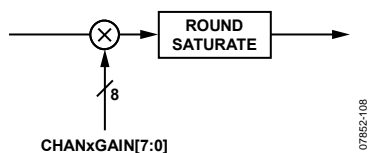

Figure 85. Individual Channel Gain Control

**DIGITAL BLOCK UPCONVERTER**

The second half of the DSP engine on the AD9789 combines the outputs of the four datapaths into one block, scales the block of channels, interpolates by 16x to the full DAC rate, and performs a band-pass filter operation allowing the block of channels to be placed anywhere in the Nyquist bandwidth of the DAC.

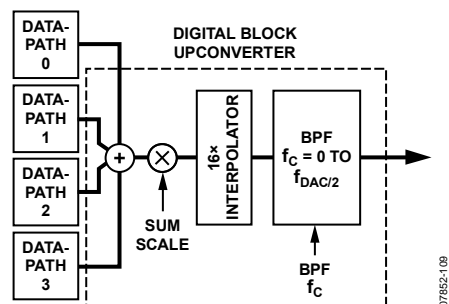

Figure 86. Functional Block Diagram of the Digital Block Upconverter

Each block of the digital block upconverter is described in more detail in the following sections.

**Summing Junction Scalar**

The summing junction scalar block operates on the sum of the four channels. The value of SUMSCALE[7:0] is programmed in Register 0x08. The scale factor applied to the data is calculated as follows:

$$ScaleFactor = \frac{SUMSCALE[7:0]}{64}$$

This factor provides a scaling range of the input data from 0 to 3.984375 with a step size of 0.015625. The default value of 0x0D provides a scale factor of 0.203125. Note that when the channels are summed, they are clipped at the output of the summing junction scalar block if the value exceeds the maximum or minimum full-scale value (0x7FFF or 0x8000). If the full 16-bit range of each individual channel is used, the sum scalar should be set to 0x10 (0.25) to avoid the possibility of clipping.

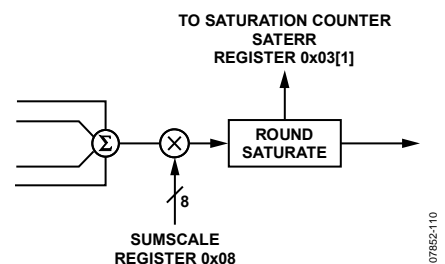

Figure 87. Block Diagram of the Summing Junction Scalar

In practice, the signal-to-noise ratio (SNR) of the channel can be improved by increasing the sum scale factor and permitting a small amount of clipping. The larger signal amplitude can improve the SNR if the clipping is brief and infrequent.

Table 54 shows recommended sum scale values for each QAM mapper mode. The criteria used to determine the recommended sum scale values were MER/EVM measurements and spectral purity. Because clipping results in impulsive noise, it can be observed in the output spectrum as a transient increase in the output noise floor. These sum scale values were chosen such that the transient increases in the noise floor were minimal. These tests were completed for one, two, three, and four carrier outputs at approximately 850 MHz. Because clipping can occur in the RF chain following the DAC, further verification of these values should be performed at the system level by adding BER tests to the sum scale selection criteria.

**Table 54. Recommended Sum Scale Values for all QAM Mapper Modes and Channel Count**

| QAM Mode       | Sum Scale Value (Decimal) |            |            |            |
|----------------|---------------------------|------------|------------|------------|
|                | 1 Channel                 | 2 Channels | 3 Channels | 4 Channels |
| DVB-C 16-QAM   | 48                        | 28         | 22         | 16         |
| DVB-C 32-QAM   | 54                        | 34         | 26         | 20         |
| DVB-C 64-QAM   | 54                        | 34         | 26         | 20         |
| DVB-C 128-QAM  | 80                        | 50         | 38         | 30         |
| DVB-C 256-QAM  | 54                        | 34         | 26         | 20         |
| DOCSIS 64-QAM  | 54                        | 34         | 26         | 20         |
| DOCSIS 256-QAM | 54                        | 34         | 26         | 20         |

### Digital 16x Tunable Band-Pass Filter

The digital band-pass filter works in conjunction with a fixed 16x interpolator (see Figure 88). The 16x interpolation filter creates 16 images of the baseband signal in the Nyquist band of the DAC. The digital band-pass filter must then be tuned to reject the 15 undesired images. The center frequency of the band-pass filter can be placed anywhere from dc to  $f_{DAC}/2$ . The tuning word for the band-pass filter center frequency can be calculated as follows:

$$BPF\_Center\_Freq = \frac{f_{CENTER}}{f_{DAC}} \times (2^{16} - 1)$$

The resulting tuning word is a 16-bit value where the most significant byte is written to Register 0x1D[7:0] and the least significant byte is written to Register 0x1C[7:0].

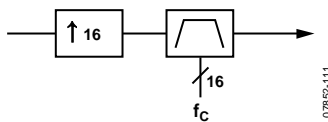

Figure 88. Conceptual Block Diagram of 16x Tunable Band-Pass Filter

The width of the filter's stop band is fixed at approximately  $f_{DAC}/64$ . The effective FLAT pass band is  $f_{DAC}/64$ . As can be inferred from Figure 89 to Figure 91, mistuning of the BPF center frequency can result in unwanted images appearing. Care

should be taken to appropriately filter the desired signal with the interpolation filters prior to the input of the BPF.

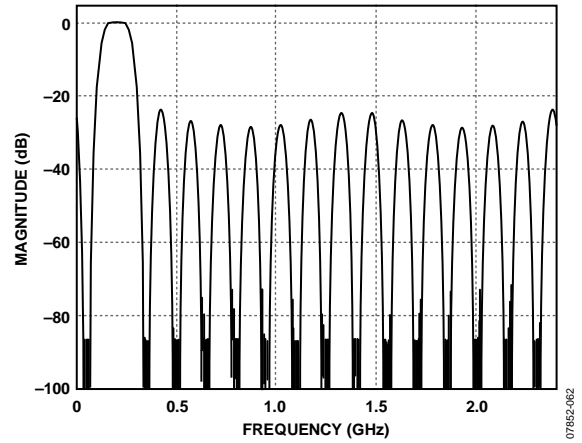

Figure 89. Band-Pass Filter Response at 200 MHz,  $f_{DAC} = 2.4$  GHz

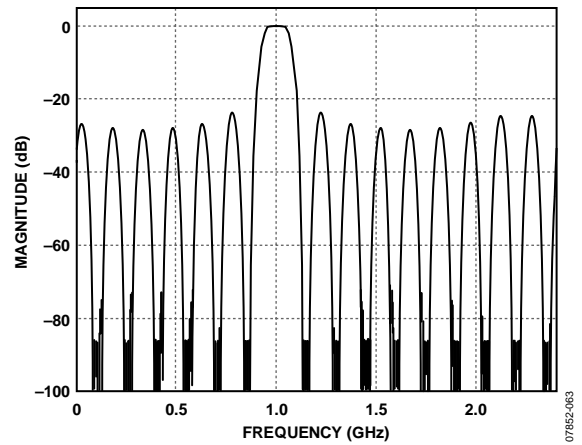

Figure 90. Band-Pass Filter Response at 1 GHz,  $f_{DAC} = 2.4$  GHz

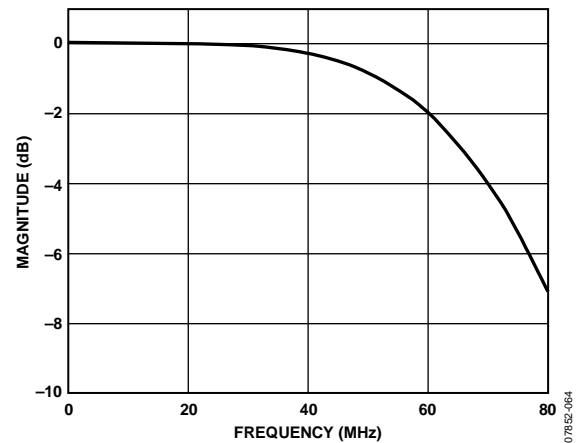

Figure 91. Band-Pass Filter Pass-Band Detail,  $f_{DAC} = 2.4$  GHz

## DIGITAL INTERFACE MODES

The AD9789 can be configured for two main digital interface modes of operation:

- Channelizer mode
- Quadrature digital upconverter (QDUC) mode

In channelizer mode (Register 0x20[3] = 0), the interface can be configured for 4- to 32-bit bus widths and can accept up to four channels of complex data. Any of the signal processing blocks in the digital datapath can be used. The maximum baud rate supported in channelizer mode is  $f_{DAC}/48$ .

In QDUC mode (Register 0x20[3] = 1), the interface is fixed at a 32-bit bus width and one channel of complex data. The available signal processing methods are interpolation ( $16\times$  to  $512\times$ ), rate conversion (0.5 to 1.0), and complex modulation. The maximum baud rate supported in QDUC mode is  $f_{DAC}/16$ .

In both channelizer and QDUC modes, the input data bus can be configured to accept LVDS or CMOS data via the CMOS\_BUS pin (L14). If CMOS\_BUS is pulled to 3.3 V, the data bus is configured to accept CMOS inputs (D[31:0], P0, and P1). If CMOS\_BUS is pulled to 0 V, the bus is configured to accept LVDS inputs (D[15:0]P, D[15:0]N, PARN, and PARN).

Two output signals are used to source data into the AD9789. The first is the data clock output signal (DCO), which is provided to clock data from the digital data source. DCO is a divided-down version of DACCLK. The second is the frame sync signal (FS), which is provided to request a new data-word. The average frequency of the FS signal is equal to the symbol rate or baud rate of the data. As with the input data bus, the DCO and FS signals can be configured as LVDS or CMOS outputs via the CMOS\_CTRL pin (M14). If CMOS\_CTRL is pulled to 3.3 V, DCO and FS are output as CMOS signals on the P14 and N14 pins (CMOS\_DCO and CMOS\_FS), respectively. If CMOS\_CTRL is pulled to 0 V, DCO and FS are output as LVDS signals on the N13, P13, L13, and M13 pins (DCOP, DCON, FSP, and FSN), respectively.

### Channelizer Mode

In channelizer mode, the digital interface has programmable bus width, data width, and data format. The bus width, which is the physical width of the digital data bus at the input of the AD9789, can be set to a 4-, 8-, 16-, or 32-bit wide interface. The data width, which is the internal width of the data at the input to the digital datapath, can be set to an 8-bit or 16-bit word. The data format can be programmed for real or complex data. A list of supported interface modes is shown in Table 55.

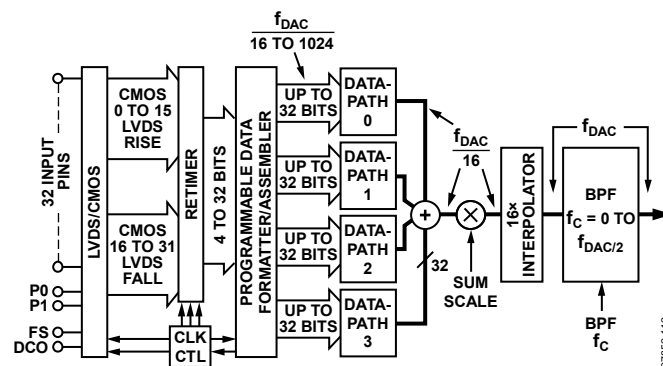

Figure 92. Channelizer Mode

Table 55. Interface Configurations Supported in Channelizer Mode

| First Input Block Enabled | Bus Width Reg. 0x21[6:5] | Data Width Reg. 0x21[4] | Data Format Reg. 0x21[3] |
|---------------------------|--------------------------|-------------------------|--------------------------|
| QAM Encoder               | 32 bits                  | 8 bits                  | Real                     |
|                           | 16 bits                  | 8 bits                  | Real                     |
|                           | 8 bits                   | 8 bits                  | Real                     |
|                           | 4 bits                   | 8 bits                  | Real                     |
| SRRC Filter               | 32 bits                  | 8 bits                  | Complex                  |
|                           | 16 bits                  | 8 bits                  | Complex                  |
|                           | 8 bits                   | 8 bits                  | Complex                  |
|                           | 4 bits                   | 8 bits                  | Complex                  |
| Interpolation Filter      | 32 bits                  | 16 bits                 | Complex                  |
|                           | 16 bits                  | 16 bits                 | Complex                  |
|                           | 8 bits                   | 16 bits                 | Complex                  |

If the QAM encoder is the first block enabled in the datapath, the data width should be set to an 8-bit word and real data format. If the SRRC filter is the first block enabled in the datapath, the data width should be set to an 8-bit word and complex data format. If both the QAM encoder and the SRRC filters are bypassed, the data width should be set to a 16-bit word and complex data format.

### Pin Mapping in Channelizer Mode

In CMOS mode (CMOS\_BUS and CMOS\_CTRL pins = 3.3 V), the various interface width options are mapped to the AD9789 input pins as shown in Table 56.

Table 56. CMOS Pin Assignments for Various Interface Widths

| Interface Width | Pin Assignments | BUSWDTH[1:0] |
|-----------------|-----------------|--------------|
| 4 bits          | D[3:0]          | 00           |
| 8 bits          | D[7:0]          | 01           |
| 16 bits         | D[15:0]         | 10           |
| 32 bits         | D[31:0]         | 11           |

In LVDS mode, the various interface width options are mapped to the AD9789 input pins as shown in Table 57. When the interface width is set to 32 bits in LVDS mode, the interface becomes double data rate (DDR). In DDR mode, the first 16 bits are sampled on the rising edge of the data sampling clock (DSC, which is synchronous to DCO), and the second 16 bits are sampled on the falling edge of DSC. All other interface widths are single data rate (SDR), where the input data is sampled on the falling edge of DSC.

**Table 57. LVDS Pin Assignments for Various Interface Widths**

| Interface Width | Pin Assignments                                 | BUSWIDTH[1:0] |
|-----------------|---|---------------|
| 4 bits          | D[3:0]P, D[3:0]N                                | 00            |
| 8 bits          | D[7:0]P, D[7:0]N                                | 01            |
| 16 bits         | D[15:0]P, D[15:0]N                              | 10            |
| 32 bits         | D[15:0]P, D[15:0]N rising edge and falling edge | 11            |

In nibble or byte loading, the most significant nibble or byte should be loaded first. Data for Channel 0 should be loaded first followed by Channel 1, Channel 2, and Channel 3. In complex data format, the in-phase part should be loaded before the quadrature part of the data-word. The data bus is LSB justified when the data for each channel is assembled internally. A few examples of how the interface maps for different configurations follow. For more information on how a particular configuration is mapped, see the Channelizer Mode Pin Mapping for CMOS and LVDS section.

### Example 1

For a CMOS interface with a 32-bit bus width, 8-bit data width, real data format, and four channels enabled, the data in Table 58 is expected on the input port after data is requested.

**Table 58. CMOS Pin Mapping for Bus Width = 32 Bits, Data Width = 8 Bits, Data Format = Real, Four Channels<sup>1</sup>**

| DCO | D[31:24] | D[23:16] | D[15:8] | D[7:0] |
|-----|----------|----------|---------|--------|
| 1   | R3       | R2       | R1      | R0     |

<sup>1</sup> R represents the real data loaded to a given channel; the channel number follows R.

### Example 2

For a CMOS interface with a 32-bit bus width, 8-bit data width, complex data format, and four channels enabled, the data in Table 59 is expected on the input port after data is requested.

**Table 59. CMOS Pin Mapping for Bus Width = 32 Bits, Data Width = 8 Bits, Data Format = Complex, Four Channels<sup>1</sup>**

| DCO | D[31:24] | D[23:16] | D[15:8] | D[7:0] |
|-----|----------|----------|---------|--------|
| 1   | Q1       | I1       | Q0      | I0     |
| 2   | Q3       | I3       | Q2      | I2     |

<sup>1</sup> I represents the in-phase term and Q represents the quadrature term of the complex data loaded to a given channel; the channel number follows I or Q.

### Example 3

For an LVDS interface with a 16-bit bus width, 8-bit data width, complex data format, and four channels enabled, the data in Table 60 is expected on the input port after data is requested.

**Table 60. LVDS Pin Mapping for Bus Width = 16 Bits, Data Width = 8 Bits, Data Format = Complex, Four Channels<sup>1</sup>**

| DCO | D[15:8]P, D[15:8]N | D[7:0]P, D[7:0]N |
|-----|--------------------|------------------|
| 1   | Q0                 | I0               |
| 2   | Q1                 | I1               |
| 3   | Q2                 | I2               |
| 4   | Q3                 | I3               |

<sup>1</sup> I represents the in-phase term and Q represents the quadrature term of the complex data loaded to a given channel; the channel number follows I or Q.

### Example 4

For an LVDS interface with a 32-bit bus width, 8-bit data width, complex data format, and four channels enabled, the data in Table 61 is expected on the input port after data is requested.

**Table 61. LVDS Pin Mapping for Bus Width = 32 Bits, Data Width = 8 Bits, Data Format = Complex, Four Channels<sup>1</sup>**

| DCO <sup>2</sup> | D[15:8]P, D[15:8]N | D[7:0]P, D[7:0]N |
|------------------|--------------------|------------------|
| 1 rise           | Q0                 | I0               |
| 1 fall           | Q1                 | I1               |
| 2 rise           | Q2                 | I2               |
| 2 fall           | Q3                 | I3               |

<sup>1</sup> I represents the in-phase term and Q represents the quadrature term of the complex data loaded to a given channel; the channel number follows I or Q.

<sup>2</sup> "Rise" means that the data is sourced on the rising edge of DCOx; "fall" means that the data is sourced on the falling edge of DCOx.

### DCO and FS Rates in Channelizer Mode

The DCO signal is a data clock output provided to clock data from the digital data source. The DCO is a divided version of the DAC clock. The FS signal is an output provided to request a new data-word. The average frequency of the FS signal ( $f_{FS}$ ) is exactly equal to the symbol rate or baud rate ( $f_{BAUD}$ ) of the data. FS is intended as a request line; timing should be taken from the DCO. The frequencies of the DCO signal ( $f_{DCO}$ ), the baud rate ( $f_{BAUD}$ ), and the DAC clock ( $f_{DAC}$ ) are related as shown by the following two equations:

$$f_{DAC} = I \times \frac{P}{Q} \times 16 \times f_{BAUD} \quad (1)$$

$$f_{DCO} = f_{DAC} / (16 \times N) \quad (2)$$

where:

I is the interpolation factor, which can range from 1 to 64.

P/Q is the rate conversion factor (0.5 to 1.0, inclusive).

N is a programmable DCO divide factor set using the DCODIV[2:0] bits in Register 0x22[6:4].

Set DCODIV[2:0] to 1, 2, or 4. A value of 0 disables the DCO. A DCODIV value of 3 is not functional. The frequency of the DSC signal is always equal to DCO.

Before choosing an interface configuration, divide the frequency of DCO by the highest frequency baud rate that will be used in the system and truncate it. The result is the number of available DCO cycles ( $\text{cycles}_{\text{AVAIL}}$ ) between FS pulses.

$$\text{cycles}_{\text{AVAIL}} = \text{floor}\left(\frac{f_{\text{DCO}}}{\max f_{\text{BAUD}}}\right)$$

Each interface configuration requires a particular number of DCO cycles between FS pulses to successfully load data into all channels. This number can be calculated using the following formula:

$$\text{cycles}_{\text{INTERFACE}} = N \times F \times \frac{DW}{BW}$$

where:

$N$  is the number of channels enabled (1 to 4).  $N$  is always equal to 4 if channel prioritization is set to 1 (see the Channel Prioritization section).

$F$  represents the data format. If the data format is real,  $F = 1$ ; if the data format is complex,  $F = 2$ .

$DW$  is the data width in number of bits (8 or 16).

$BW$  is the bus width in number of bits (4, 8, 16, or 32).

For a successful interface design, the number of DCO cycles between FS pulses must be greater than the number of DCO cycles required by the interface.

### Design Example

In this example, a system has the baud rate  $f_{\text{FS}} = 6.4$  MHz. If a 4-bit-wide interface is desired for four channels with real data format and a data width of 8 bits, the selected  $f_{\text{DCO}}$  should be at least  $8 \times f_{\text{FS}}$ . First, using Equation 1 and Equation 2, evaluate the interface speed with  $N = 1$ ,  $P/Q = 0.7$ , and  $I = 32$ .

$$f_{\text{DAC}} = 32 \times 0.7 \times 16 \times 6.4 \text{ MHz} = 2293.76 \text{ MHz}$$

$$f_{\text{DCO}} = 2293.76 \text{ MHz} / (16 \times 1) = 143.36 \text{ MHz}$$

The  $f_{\text{DCO}}/f_{\text{BAUD}}$  ratio = 22.4. If a value of  $N = 2$  is selected, the number of available DCO cycles is reduced to 11; this option may not be feasible when the latency values are taken into account. See the Latency Effects on Channelizer Mode section for more information about latency.

### Channel Prioritization

When channels are enabled and disabled, the input interface mapping can be affected. If channel prioritization (Register 0x20[2]) is set to 0, the device expects input samples for only the channels that are enabled. In this configuration, the physical channel mapping at the DUT input can move around based on the number of channels enabled, where Channel 0 has highest priority (it never moves location when enabled). If channel prioritization is set to 1, data is expected for all four channels but the data is ignored internally if the channel is disabled.

This method is recommended because enabling and disabling channels does not shift the input data bus.

If the number of channels enabled is always less than four and the user does not plan to enable and disable channels dynamically, setting channel prioritization to 0 is the best choice because fewer clocks and/or pins are required to transfer the input data.

An example of channel prioritization set to 0 is shown in Table 62. In this example, the data interface is configured for CMOS with 32-bit bus width, 8-bit data width, and real data format.

**Table 62. Input Mapping vs. Enabled Channels, Channel Prioritization = 0**

| Channels                      | CMOS Bit Mapping |           |           |           |
|-------------------------------|------------------|-----------|-----------|-----------|
|                               | [D31:D24]        | [D23:D16] | [D15:D8]  | [D7:D0]   |
| 4 Channels Enabled            | Channel 3        | Channel 2 | Channel 1 | Channel 0 |
| Channel 0 Disabled            |                  | Channel 3 | Channel 2 | Channel 1 |
| Channel 0, Channel 2 Disabled |                  |           | Channel 3 | Channel 1 |

The same example behaves differently when channel prioritization is set to 1, as shown in Table 63.

**Table 63. Input Mapping vs. Enabled Channels, Channel Prioritization = 1**

| Channels                      | CMOS Bit Mapping |           |           |           |
|-------------------------------|------------------|-----------|-----------|-----------|
|                               | [D31:D24]        | [D23:D16] | [D15:D8]  | [D7:D0]   |
| 4 Channels Enabled            | Channel 3        | Channel 2 | Channel 1 | Channel 0 |
| Channel 0 Disabled            | Channel 3        | Channel 2 | Channel 1 |           |
| Channel 0, Channel 2 Disabled | Channel 3        |           | Channel 1 |           |

### Quadrature Digital Upconverter (QDUC) Mode

In QDUC mode (Register 0x20[3] = 1), the data interface is fixed at a 32-bit bus width, 16-bit data width, and complex data format. In QDUC mode, only one channel should be enabled. If more than one channel is enabled, identical I and Q data is sent to each enabled channel. Within the datapath, the QAM mapper and the SRRC filter must be bypassed (Register 0x06[7:6] = 11).

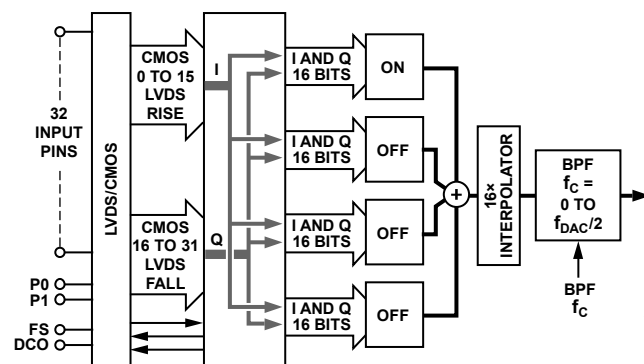

Figure 93. QDUC Mode

07852-089



# AD9789

## Pin Mapping in QDUC Mode

In CMOS mode, the AD9789 input pins are mapped as shown in Table 64.

**Table 64. Pin Mapping in QDUC Mode for CMOS Interface**

| Data Bit | Description         | Pin No. |
|----------|---------------------|---------|
| D31      | MSB of I data       | L5      |
| D16      | LSB of I data       | P8      |
| D15      | MSB of Q data       | L9      |
| D0       | LSB of Q data       | P12     |
| P1       | Parity for D[31:16] | L4      |
| P0       | Parity for D[15:0]  | M4      |

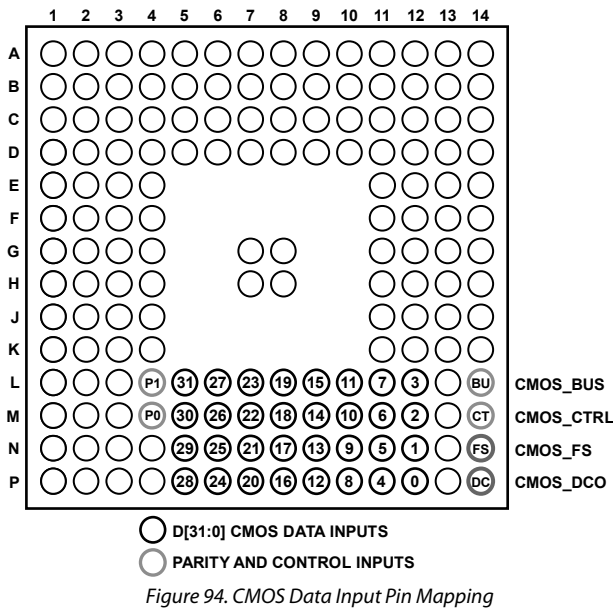

Figure 94. CMOS Data Input Pin Mapping

In LVDS mode, the AD9789 input pins are mapped as shown in Table 65.

**Table 65. Pin Mapping in QDUC Mode for LVDS Interface<sup>1</sup>**

| Data Bit           | Description                           | Pin No.  |
|--------------------|---------------------------------------|----------|
| D15P, D15N rising  | MSB of I data                         | L5, M5   |
| D0P, D0N rising    | LSB of I data                         | N12, P12 |
| D15P, D15N falling | MSB of Q data                         | L5, M5   |
| D0P, D0N falling   | LSB of Q data                         | N12, P12 |
| PARP, PARN rising  | Parity for D[15:0]P, D[15:0]N rising  | L4, M4   |
| PARP, PARN falling | Parity for D[15:0]P, D[15:0]N falling | L4, M4   |

<sup>1</sup> "Rising" means that the data is sourced on the rising edge of DCOx; "falling" means that the data is sourced on the falling edge of DCOx.

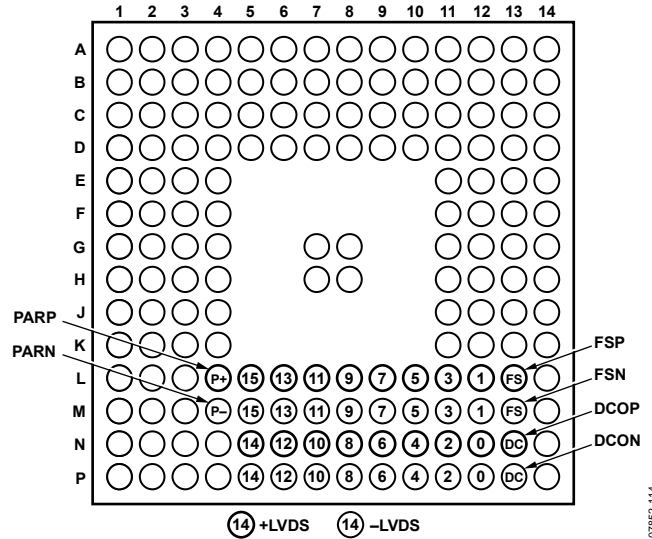

Figure 95. LVDS Data Input Pin Mapping

## DCO and FS Rates in QDUC Mode

In QDUC mode, DCO<sub>DIV</sub> should always be set to 1 (Register 0x22[6:4] = 001). The clock period of DCO is equal to 16 DAC clock periods. When only 16× interpolation is required and the rate converter is not used, the data rate of the interface is equal to  $f_{DCO}$ .

If further interpolation or rate conversion is enabled in the datapath, the data rate of the interface is  $f_{BAUD}$ . The average rate of FS,  $f_{FS}$ , is equal to the baud rate,  $f_{BAUD}$ . The baud rate can be specified by the following equation:

$$f_{BAUD} = \frac{f_{DCO}}{2^N \times \frac{P}{Q}}$$

where:

$N$  is the number of 2× interpolation filters enabled.

$P/Q$  is the rate converter ratio.

The FS signal becomes a request for data that effectively gates the DCO clock and ensures that data is sent at the correct baud rate. If  $P/Q = 1$  and  $N = 0$ , DCO occurs at the baud rate and FS is not required. In this case, FS is inactive (always high). The DCO signal can be used as a constant rate clock to request samples from the data source.

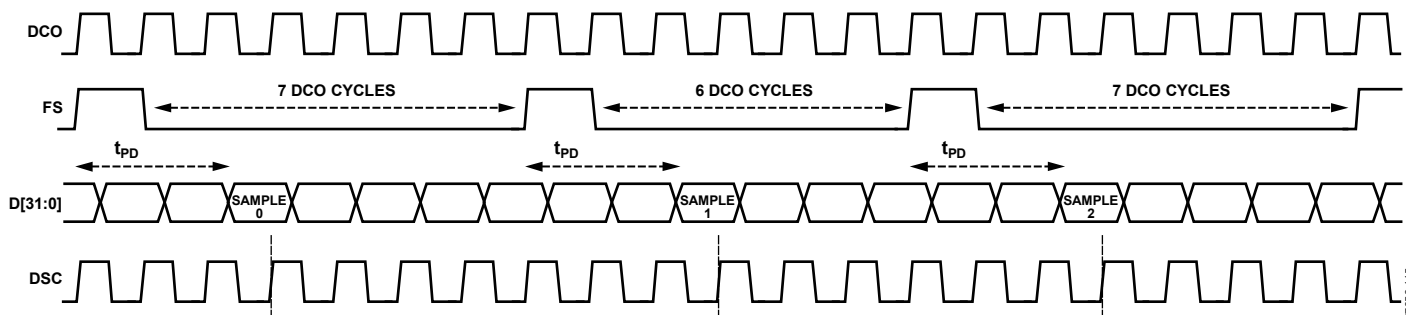

Figure 96. QDUC Mode Interface Timing Diagram for Design Example When FS Is Active

**Design Example**

In this example, a system has a DAC rate of 1600 MHz and a baud rate of 15 MHz. Because  $f_{DCO} = f_{DAC}/16 = 100$  MHz, the ratio of  $f_{DCO}/f_{FS} = 6.667$ . To satisfy the requirement that P/Q be between 0.5 and 1.0, an additional interpolation factor of  $8 \times$  must be applied, so  $N = 3$ . Solving for P/Q results in 5/6.

Therefore, three out of every 20 DCO clock edges should result in data samples being loaded into the device (the ratio of  $f_{FS}/f_{DCO} = 3/20$ ). Figure 96 shows a timing diagram that illustrates the operation of the interface in this example. In the timing diagram,  $t_{PD}$  corresponds to the propagation delay between the rising edge of FS and when the first sample in a given transmission is sampled into the AD9789. Note that  $t_{PD}$  can vary by more than 1 DCO cycle.

**Retimer Operation**

The AD9789 uses a three-register retimer. The first two registers are clocked from any one of 16 phases derived from the DAC clock. The clock for the last register is fixed to Phase 15. The programmable register clocks are the digital sample clock (DSC) and the synchronizer clock (SNC). By choosing different phases, fine adjustment of the sampling time can be made to adjust for delays in the data source. Register 0x23[7:4] sets the DSC phase (DSCPHZ) and Register 0x23[3:0] sets the SNC phase (SNCPHZ) to any one of the 16 phases. The last register in the chain is always clocked from Phase 15.

The parity counters can aid in identifying the edges of the data valid windows. Operation in CMOS mode is quite similar to operation in LVDS mode, as can be seen in Figure 97 and Figure 98.

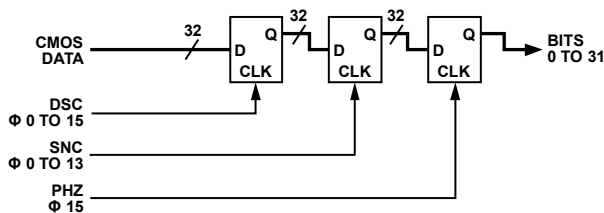

Figure 97. CMOS Retiming Registers

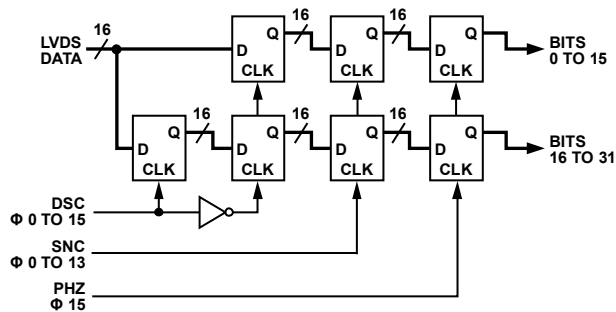

Figure 98. LVDS Rearranges the DSC Register

Register 0x23 and Register 0x21[2:0] can provide timing adjustments with very low jitter penalty, but they can also be set to the following recommended safe values:

- In LVDS mode, DSCPHZ = 0, SNCPHZ = 3, LTNCY = 0 (see the Latency Register section)
- In CMOS mode, DSCPHZ = 0, SNCPHZ = 7, LTNCY = 0 (see the Latency Register section)

Timing adjustments can then be made in an FPGA or other data source.

Note that selecting Phase 14 or Phase 15 for SNCPHZ results in a timing violation. In CMOS mode, setting DSCPHZ one step behind or at SNCPHZ also results in a timing violation.

**Latency Register**

A latency register, controlled via Register 0x21[2:0], follows the three-register retimer and can delay the data up to seven DCO clocks in steps of one DCO clock. The critical retiming is already done in the first three registers, so an incorrect latency value does not result in a timing violation. The latency value determines which data sample is the first sample in a transmission and routes that sample to the appropriate channel. Latency is affected by the round-trip delay from when FS goes high to when the first data sample is output from the retimer. If the latency value programmed into the part is incorrect, the input data samples will not be assembled properly.

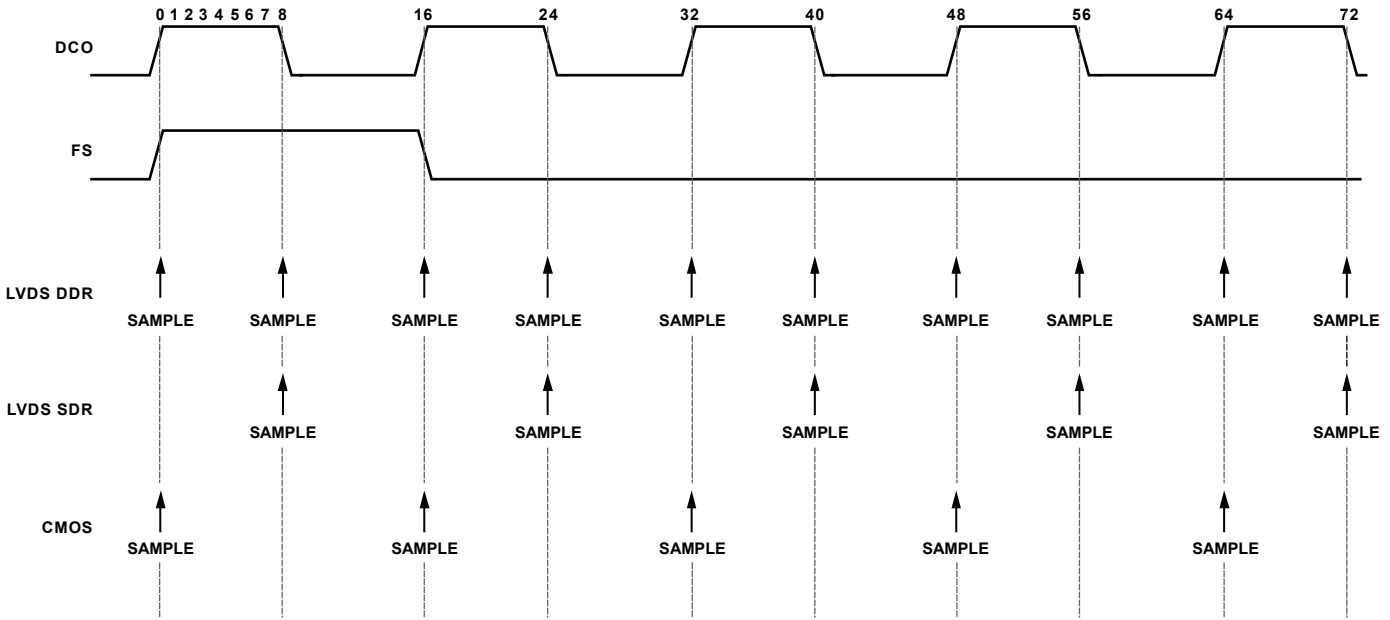

Figure 99. Sampling Points at Delay = 0

07852-116

## Retimer and Latency Look-Up Tables

In practice, the retimer and latency parameters can be reduced to a single verified and guaranteed table that provides delays at optimum sample points from 0 to over 100 DAC clocks. The sampling points for LVDS DDR, LVDS SDR, and CMOS interface modes are given in Figure 99 for delay = 0. The number scale above the DCO signal in Figure 99 corresponds to the delay value in DAC clock cycles in Table 66 and Table 67.

The delay of the pins should be taken into account. This delay is 800 ps for the output delay and 800 ps for the input delay, for a total of 1.6 ns. This delay is included in the following formulas. See Table 66 for a complete set of recommended retimer settings for all delay values. Note: for LVDS DDR, zero (0) measured delay results in a retimer setting of 20, while for LVDS SDR or CMOS, the zero(0) delay corresponds to a retimer setting of 12 at  $f_{DAC} = 2.4$  GHz.

To use Table 66 and Table 67, probe the FS, DCO, and data input signals at the AD9789. While viewing these signals on an oscilloscope, measure the delay between the rising edge of FS and the start of the first data sample and add 1.6 ns from the delay of the pins to this value. Normalize this total delay to one DAC clock period. The optimum sampling point in number of DAC clock cycles, which corresponds to the delay number in Table 66 and Table 67, can be found from this measured value for each interface mode.

For LVDS DDR,

$$Delay_{OPTIMAL} = \frac{Delay_{MEASURED} + 1.6 \text{ ns}}{t_{DCO} / 16} + 16$$

For LVDS SDR,

$$Delay_{OPTIMAL} = \frac{Delay_{MEASURED} + 1.6 \text{ ns}}{t_{DCO} / 16} + 8$$

For CMOS,

$$Delay_{OPTIMAL} = \frac{Delay_{MEASURED} + 1.6 \text{ ns}}{t_{DCO} / 16} + 8$$

For a maximum valid sampling window, the sampling point should be fine-tuned based on the data input setup and hold times. If the setup and hold times are symmetric about the DCO edge, choosing a sampling point at the center of the data window results in the maximum valid sampling window. For more information on the input data setup and hold times, refer to the CMOS Interface Timing section or the LVDS Interface Timing section.

The LAT, SNC, and DSC values for the optimal sampling point in Table 66 or Table 67 should be written to the LTNCY[2:0] bits in Register 0x21[2:0], the SNCPHZ[3:0] bits in Register 0x23[3:0], and the DSCPHZ[3:0] bits in Register 0x23[7:4], respectively.

**Table 66. Recommended Retimer Settings for All Delay Values, LVDS Mode**

| Delay | 0  | 1  | 2  | 3  | 4  | 5  | 6  | 7  |
|-------|----|----|----|----|----|----|----|----|
| LAT   | 0  | 0  | 0  | 0  | 0  | 0  | 1  | 1  |
| SNC   | 7  | 8  | 9  | 9  | 10 | 10 | 2  | 3  |
| DSC   | 8  | 9  | 10 | 11 | 12 | 13 | 14 | 15 |
| Delay | 8  | 9  | 10 | 11 | 12 | 13 | 14 | 15 |
| LAT   | 1  | 1  | 1  | 1  | 1  | 1  | 1  | 1  |
| SNC   | 3  | 4  | 4  | 5  | 5  | 6  | 6  | 7  |
| DSC   | 0  | 1  | 2  | 3  | 4  | 5  | 6  | 7  |
| Delay | 16 | 17 | 18 | 19 | 20 | 21 | 22 | 23 |
| LAT   | 1  | 1  | 1  | 1  | 1  | 1  | 2  | 2  |
| SNC   | 7  | 8  | 9  | 9  | 10 | 10 | 2  | 3  |
| DSC   | 8  | 9  | 10 | 11 | 12 | 13 | 14 | 15 |
| Delay | 24 | 25 | 26 | 27 | 28 | 29 | 30 | 31 |
| LAT   | 2  | 2  | 2  | 2  | 2  | 2  | 2  | 2  |
| SNC   | 3  | 4  | 4  | 5  | 5  | 6  | 6  | 7  |
| DSC   | 0  | 1  | 2  | 3  | 4  | 5  | 6  | 7  |
| Delay | 32 | 33 | 34 | 35 | 36 | 37 | 38 | 39 |
| LAT   | 2  | 2  | 2  | 2  | 2  | 2  | 3  | 3  |
| SNC   | 7  | 8  | 9  | 9  | 10 | 10 | 2  | 3  |
| DSC   | 8  | 9  | 10 | 11 | 12 | 13 | 14 | 15 |
| Delay | 40 | 41 | 42 | 43 | 44 | 45 | 46 | 47 |
| LAT   | 3  | 3  | 3  | 3  | 3  | 3  | 3  | 3  |
| SNC   | 3  | 4  | 4  | 5  | 5  | 6  | 6  | 7  |
| DSC   | 0  | 1  | 2  | 3  | 4  | 5  | 6  | 7  |
| Delay | 48 | 49 | 50 | 51 | 52 | 53 | 54 | 55 |
| LAT   | 3  | 3  | 3  | 3  | 3  | 3  | 4  | 4  |
| SNC   | 7  | 8  | 9  | 9  | 10 | 10 | 2  | 3  |
| DSC   | 8  | 9  | 10 | 11 | 12 | 13 | 14 | 15 |
| Delay | 56 | 57 | 58 | 59 | 60 | 61 | 62 | 63 |
| LAT   | 4  | 4  | 4  | 4  | 4  | 4  | 4  | 4  |
| SNC   | 3  | 4  | 4  | 5  | 5  | 6  | 6  | 7  |
| DSC   | 0  | 1  | 2  | 3  | 4  | 5  | 6  | 7  |
| Delay | 64 | 65 | 66 | 67 | 68 | 69 | 70 | 71 |
| LAT   | 4  | 4  | 4  | 4  | 4  | 4  | 5  | 5  |
| SNC   | 7  | 8  | 9  | 9  | 10 | 10 | 2  | 3  |
| DSC   | 8  | 9  | 10 | 11 | 12 | 13 | 14 | 15 |
| Delay | 72 | 73 | 74 | 75 | 76 | 77 | 78 | 79 |
| LAT   | 5  | 5  | 5  | 5  | 5  | 5  | 5  | 5  |
| SNC   | 3  | 4  | 4  | 5  | 5  | 6  | 6  | 7  |
| DSC   | 0  | 1  | 2  | 3  | 4  | 5  | 6  | 7  |
| Delay | 80 | 81 | 82 | 83 | 84 | 85 | 86 | 87 |
| LAT   | 5  | 5  | 5  | 5  | 5  | 5  | 6  | 6  |
| SNC   | 7  | 8  | 9  | 9  | 10 | 10 | 2  | 3  |
| DSC   | 8  | 9  | 10 | 11 | 12 | 13 | 14 | 15 |
| Delay | 88 | 89 | 90 | 91 | 92 | 93 | 94 | 95 |
| LAT   | 6  | 6  | 6  | 6  | 6  | 6  | 6  | 6  |
| SNC   | 3  | 4  | 4  | 5  | 5  | 6  | 6  | 7  |
| DSC   | 0  | 1  | 2  | 3  | 4  | 5  | 6  | 7  |

| Delay | 96  | 97  | 98  | 99  | 100 | 101 | 102 | 103 |
|-------|-----|-----|-----|-----|-----|-----|-----|-----|
| LAT   | 6   | 6   | 6   | 6   | 6   | 6   | 7   | 7   |
| SNC   | 7   | 8   | 9   | 9   | 10  | 10  | 2   | 3   |
| DSC   | 8   | 9   | 10  | 11  | 12  | 13  | 14  | 15  |
| Delay | 104 | 105 | 106 | 107 | 108 | 109 | 110 | 111 |
| LAT   | 7   | 7   | 7   | 7   | 7   | 7   | 7   | 7   |
| SNC   | 3   | 4   | 4   | 5   | 5   | 6   | 6   | 7   |
| DSC   | 0   | 1   | 2   | 3   | 4   | 5   | 6   | 7   |
| Delay | 112 | 113 | 114 | 115 | 116 | 117 | X   | X   |
| LAT   | 7   | 7   | 7   | 7   | 7   | 7   | X   | X   |
| SNC   | 7   | 8   | 9   | 9   | 10  | 10  | X   | X   |
| DSC   | 8   | 9   | 10  | 11  | 12  | 13  | X   | X   |

**Table 67. Recommended Retimer Settings for All Delay Values, CMOS Mode**

| Delay | 0  | 1  | 2  | 3  | 4  | 5  | 6  | 7  |
|-------|----|----|----|----|----|----|----|----|
| LAT   | 0  | 0  | 0  | 0  | 0  | 0  | 1  | 1  |
| SNC   | 7  | 8  | 8  | 9  | 9  | 2  | 2  | 3  |
| DSC   | 0  | 1  | 2  | 3  | 4  | 5  | 6  | 7  |
| Delay | 8  | 9  | 10 | 11 | 12 | 13 | 14 | 15 |
| LAT   | 1  | 1  | 1  | 1  | 1  | 1  | 1  | 1  |
| SNC   | 3  | 4  | 4  | 5  | 5  | 6  | 6  | 7  |
| DSC   | 8  | 9  | 10 | 11 | 12 | 13 | 14 | 15 |
| Delay | 16 | 17 | 18 | 19 | 20 | 21 | 22 | 23 |
| LAT   | 1  | 1  | 1  | 1  | 1  | 1  | 2  | 2  |
| SNC   | 7  | 8  | 8  | 9  | 9  | 2  | 2  | 3  |
| DSC   | 0  | 1  | 2  | 3  | 4  | 5  | 6  | 7  |
| Delay | 24 | 25 | 26 | 27 | 28 | 29 | 30 | 31 |
| LAT   | 2  | 2  | 2  | 2  | 2  | 2  | 2  | 2  |
| SNC   | 3  | 4  | 4  | 5  | 5  | 6  | 6  | 7  |
| DSC   | 8  | 9  | 10 | 11 | 12 | 13 | 14 | 15 |
| Delay | 32 | 33 | 34 | 35 | 36 | 37 | 38 | 39 |
| LAT   | 2  | 2  | 2  | 2  | 2  | 2  | 3  | 3  |
| SNC   | 7  | 8  | 8  | 9  | 9  | 2  | 2  | 3  |
| DSC   | 0  | 1  | 2  | 3  | 4  | 5  | 6  | 7  |
| Delay | 40 | 41 | 42 | 43 | 44 | 45 | 46 | 47 |
| LAT   | 3  | 3  | 3  | 3  | 3  | 3  | 3  | 3  |
| SNC   | 3  | 4  | 4  | 5  | 5  | 6  | 6  | 7  |
| DSC   | 8  | 9  | 10 | 11 | 12 | 13 | 14 | 15 |
| Delay | 48 | 49 | 50 | 51 | 52 | 53 | 54 | 55 |
| LAT   | 3  | 3  | 3  | 3  | 3  | 3  | 4  | 4  |
| SNC   | 7  | 8  | 8  | 9  | 9  | 2  | 2  | 3  |
| DSC   | 0  | 1  | 2  | 3  | 4  | 5  | 6  | 7  |
| Delay | 56 | 57 | 58 | 59 | 60 | 61 | 62 | 63 |
| LAT   | 4  | 4  | 4  | 4  | 4  | 4  | 4  | 4  |
| SNC   | 3  | 4  | 4  | 5  | 5  | 6  | 6  | 7  |
| DSC   | 8  | 9  | 10 | 11 | 12 | 13 | 14 | 15 |
| Delay | 64 | 65 | 66 | 67 | 68 | 69 | 70 | 71 |
| LAT   | 4  | 4  | 4  | 4  | 4  | 4  | 5  | 5  |
| SNC   | 3  | 4  | 4  | 5  | 5  | 6  | 6  | 7  |
| DSC   | 8  | 9  | 10 | 11 | 12 | 13 | 14 | 15 |
| Delay | 72 | 73 | 74 | 75 | 76 | 77 | 78 | 79 |
| LAT   | 4  | 4  | 4  | 4  | 4  | 4  | 5  | 5  |
| SNC   | 7  | 8  | 8  | 9  | 9  | 2  | 2  | 3  |
| DSC   | 8  | 9  | 10 | 11 | 12 | 13 | 14 | 15 |
| Delay | 80 | 81 | 82 | 83 | 84 | 85 | 86 | 87 |
| LAT   | 5  | 5  | 5  | 5  | 5  | 5  | 6  | 6  |
| SNC   | 7  | 8  | 9  | 9  | 10 | 10 | 2  | 3  |
| DSC   | 8  | 9  | 10 | 11 | 12 | 13 | 14 | 15 |
| Delay | 88 | 89 | 90 | 91 | 92 | 93 | 94 | 95 |
| LAT   | 6  | 6  | 6  | 6  | 6  | 6  | 6  | 6  |
| SNC   | 3  | 4  | 4  | 5  | 5  | 6  | 6  | 7  |
| DSC   | 0  | 1  | 2  | 3  | 4  | 5  | 6  | 7  |

|              |            |            |            |            |            |            |            |            |
|--------------|------------|------------|------------|------------|------------|------------|------------|------------|
| <b>Delay</b> | <b>72</b>  | <b>73</b>  | <b>74</b>  | <b>75</b>  | <b>76</b>  | <b>77</b>  | <b>78</b>  | <b>79</b>  |
| LAT          | 5          | 5          | 5          | 5          | 5          | 5          | 5          | 5          |
| SNC          | 3          | 4          | 4          | 5          | 5          | 6          | 6          | 7          |
| DSC          | 8          | 9          | 10         | 11         | 12         | 13         | 14         | 15         |
| <b>Delay</b> | <b>80</b>  | <b>81</b>  | <b>82</b>  | <b>83</b>  | <b>84</b>  | <b>85</b>  | <b>86</b>  | <b>87</b>  |
| LAT          | 5          | 5          | 5          | 5          | 5          | 5          | 6          | 6          |
| SNC          | 7          | 8          | 8          | 9          | 9          | 2          | 2          | 3          |
| DSC          | 0          | 1          | 2          | 3          | 4          | 5          | 6          | 7          |
| <b>Delay</b> | <b>88</b>  | <b>89</b>  | <b>90</b>  | <b>91</b>  | <b>92</b>  | <b>93</b>  | <b>94</b>  | <b>95</b>  |
| LAT          | 6          | 6          | 6          | 6          | 6          | 6          | 6          | 6          |
| SNC          | 3          | 4          | 4          | 5          | 5          | 6          | 6          | 7          |
| DSC          | 8          | 9          | 10         | 11         | 12         | 13         | 14         | 15         |
| <b>Delay</b> | <b>96</b>  | <b>97</b>  | <b>98</b>  | <b>99</b>  | <b>100</b> | <b>101</b> | <b>102</b> | <b>103</b> |
| LAT          | 6          | 6          | 6          | 6          | 6          | 6          | 7          | 7          |
| SNC          | 7          | 8          | 8          | 9          | 9          | 2          | 2          | 3          |
| DSC          | 0          | 1          | 2          | 3          | 4          | 5          | 6          | 7          |
| <b>Delay</b> | <b>104</b> | <b>105</b> | <b>106</b> | <b>107</b> | <b>108</b> | <b>109</b> | <b>110</b> | <b>111</b> |
| LAT          | 7          | 7          | 7          | 7          | 7          | 7          | 7          | 7          |
| SNC          | 3          | 4          | 4          | 5          | 5          | 6          | 6          | 7          |
| DSC          | 8          | 9          | 10         | 11         | 12         | 13         | 14         | 15         |
| <b>Delay</b> | <b>112</b> | <b>113</b> | <b>114</b> | <b>115</b> | <b>116</b> | <b>117</b> | <b>X</b>   | <b>X</b>   |
| LAT          | 7          | 7          | 7          | 7          | 7          | 7          | X          | X          |
| SNC          | 7          | 8          | 8          | 9          | 9          | 2          | X          | X          |
| DSC          | 0          | 1          | 2          | 3          | 4          | 5          | X          | X          |

### Latency Effects on Channelizer Mode

When selecting an interface configuration in channelizer mode, the number of DCO cycles between FS pulses ( $cycles_{AVAIL}$ ) must be greater than the number of DCO cycles required by the interface configuration ( $cycles_{INTERFACE}$ ). Latency consumes some of these available DCO cycles between FS. This decrease in available DCO cycles is a result of the round-trip propagation delay from the FS output of the AD9789 to the respective data sample at the input of the AD9789 (LTNCY[2:0]) in addition to the internal latency of the device.

For a successful interface design, the following condition must be met:

$$cycles_{AVAIL} \geq cycles_{INTERFACE} + LTNCY[2:0] + 2$$

### CMOS Interface Timing

When the AD9789 is configured with a CMOS interface (CMOS\_CTRL = CMOS\_BUS = 3.3 V), a CMOS data clock output signal, DCO, is provided to drive data from the data source. The output signal operates at the input data rate, which is equal to  $f_{DAC}/16$  when DCODIV = 1. CMOS data on the bus is sampled on the rising edge of an internal sampling clock (DSC). Note that the frequency of DCO is equal to the frequency of DSC and the phase relationship between DCO and DSC is determined by DSCPHZ (Register 0x23[7:4]).

The timing of the input data is referenced to DCO for a given phase of DSC. The CMOS data input timing over temperature is shown in Table 68 for DCO\_INV = 0 (Register 0x20[4]), DSCPHZ = 0 (Register 0x23[7:4]), and DCODIV = 1 (Register 0x22[6:4]). Table 68 also shows the data valid window (DVW). The data valid window is the sum of the setup and hold times of the interface. DVW is the minimum amount of time that valid data must be presented to the device to ensure proper sampling.

**Table 68. CMOS Data Input Timing with Respect to DCO**

| Temperature    | Min $t_s$ (ns) | Min $t_H$ (ns) | Min DVW (ns) |
|----------------|----------------|----------------|--------------|
| -40°C          | 4.9            | -1.4           | 3.5          |
| +25°C          | 5.1            | -1.6           | 3.5          |
| +85°C          | 5.3            | -1.7           | 3.6          |
| -40°C to +85°C | 5.3            | -1.4           | 3.9          |

For any value of DSCPHZ greater than 0, the setup and hold times shift by increments of  $t_{DCO}/16$ , where  $t_{DCO}$  is the period of the data clock.

$$t_s = 5.3 \text{ ns} - ((t_{DCO}/16) \times DSCPHZ)$$

$$t_H = 0.24 \text{ ns} + ((t_{DCO}/16) \times DSCPHZ)$$

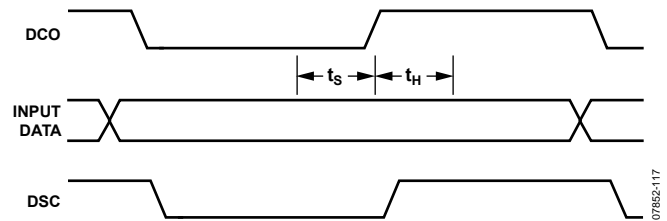

Figure 100. CMOS Input Timing

In some interface modes, the delay from the rising edge of DCO to the rising edge of FS needs to be known. This delay is summarized over temperature in Table 69.

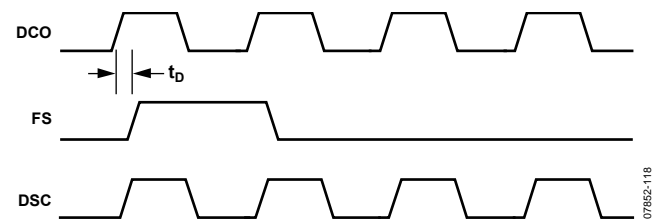

Figure 101. CMOS\_DCO to CMOS\_FS Delay

**Table 69. Timing Delay Between CMOS\_DCO and CMOS\_FS**

| Temperature    | $t_{D, MAX}$ DCO to FS (ns) | $t_{D, MIN}$ DCO to FS (ns) |
|----------------|-----------------------------|-----------------------------|
| -40°C          | 0.64                        | 0.28                        |
| +25°C          | 0.71                        | 0.4                         |
| +85°C          | 0.85                        | 0.49                        |
| -40°C to +85°C | 0.85                        | 0.28                        |

**LVDS Interface Timing**

When the AD9789 is configured with an LVDS interface (CMOS\_CTRL = CMOS\_BUS = 0 V), an LVDS data clock output signal, DCO, is provided to drive data from the data source. The LVDS interface may be single data rate (SDR) or double data rate (DDR) depending on the bus width configuration. In SDR, data is sampled into the part only on the falling edge of the internal sampling clock (DSC). Note that the frequency of DCO is equal to the frequency of DSC, so the effective data rate is equal to the DCO frequency. The phase relationship between DCO and DSC is determined by DSCPHZ (Register 0x23[7:4]). In DDR, data is sampled into the part on both the rising and falling edges of DSC, so the effective data rate is equal to twice the DCO frequency. The interface is DDR only when the bus width is equal to 32 bits. The DCO frequency is equal to  $f_{DAC}/16$  when DCODIV = 1. The timing of the input data is referenced to DCO for a given phase of DSC. The LVDS input data timing over temperature is shown in Table 70 for DCO\_INV = 0 (Register 0x20[4]), DSCPHZ = 0 (Register 0x23[7:4]), and DCODIV = 1 (Register 0x22[6:4]).

**Table 70. LVDS Data Input Timing with Respect to DCO**

| Temperature    | Min $t_s$ (ns) | Min $t_H$ (ns) | Min DVW (ns) |
|----------------|----------------|----------------|--------------|
| -40°C          | 1.04           | 0.24           | 1.28         |
| +25°C          | 1.23           | 0.16           | 1.39         |
| +85°C          | 1.41           | 0.03           | 1.44         |
| -40°C to +85°C | 1.41           | 0.24           | 1.65         |

In DDR mode, these setup and hold times must be applied to both edges of DCO. In SDR mode, these setup and hold times must be applied to the falling edge of DCO.

For any value of DSCPHZ greater than 0, the setup and hold times shift by increments of  $t_{DCO}/16$ , where  $t_{DCO}$  is the period of the data clock.

$$t_s = 1.41 \text{ ns} - ((t_{DCO}/16) \times DSCPHZ)$$

$$t_H = 0.24 \text{ ns} + ((t_{DCO}/16) \times DSCPHZ)$$

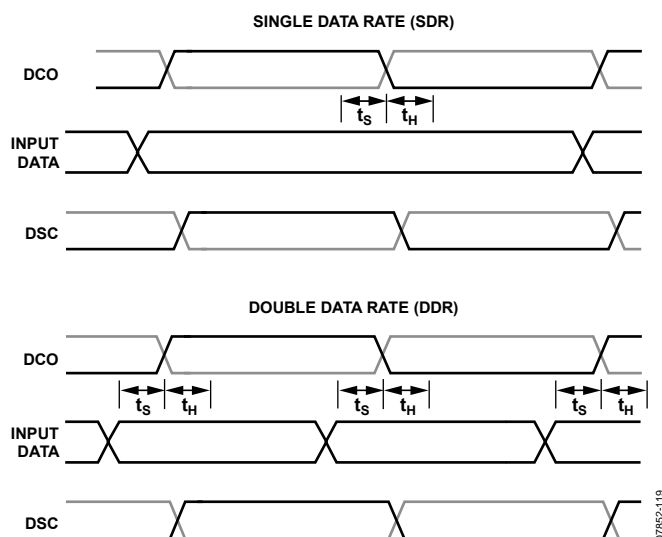

Figure 102. LVDS Input Timing, SDR vs. DDR

In some interface modes, the delay from the rising edge of DCO to the rising edge of FS needs to be known. This delay is summarized over temperature in Table 71.

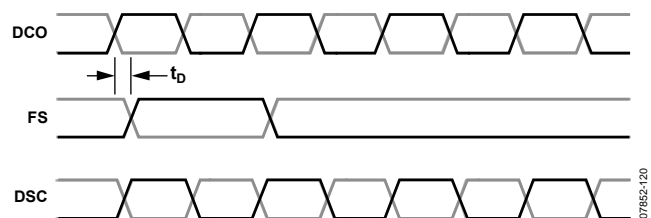

Figure 103. LVDS DCO to FS Delay

**Table 71. Timing Delay Between LVDS DCO and FS**

| Temperature    | $t_{D, MAX}$ DCO to FS (ns) | $t_{D, MIN}$ DCO to FS (ns) |
|----------------|-----------------------------|-----------------------------|
| -40°C          | 0.37                        | 0.21                        |
| +25°C          | 0.35                        | 0.16                        |
| +85°C          | 0.32                        | 0.12                        |
| -40°C to +85°C | 0.37                        | 0.12                        |

**Parity**

The AD9789 supports parity checking on the input data bus. There are three parity checking modes: even parity, odd parity, and IQ parity. In IQ parity mode, a value of 0 is always expected on the I channel and a value of 1 is always expected on the Q channel. Note that IQ parity mode is generally useful only when the LVDS interface is used. These modes are controlled via Register 0x20[1:0].

**Table 72. Parity Mode SPI Settings**

| Parity Mode                 | Register 0x20[1:0] |
|-----------------------------|--------------------|
| Deactivates Parity Checking | 00                 |
| IQ Parity                   | 01                 |
| Even Parity                 | 10                 |
| Odd Parity                  | 11                 |

If parity checking is used, each data-word that is transferred into the AD9789 should have a parity bit accompanying it, regardless of FS. In other words, parity must be valid for every DCO edge. The parity bits are located at Pin L4 and Pin M4. When operating the interface in CMOS mode, the input parity bits are referred to as P1 and P0, respectively. When operating the interface in LVDS mode, the input parity bits are referred to as PARN and PARP, respectively.

Recall that the LVDS interface can be single data rate (SDR) or double data rate (DDR), depending on the bus width configuration. The interface is DDR only when the bus width is equal to 32 bits.

In QDUC mode, where the interface is fixed at a 32-bit bus width, the parity behavior is straightforward (see Table 73).

**Table 73. Parity Behavior in QDUC Mode**

| Interface                  | Bus Width | Even/Odd Parity  | IQ Parity  |
|----------------------------|-----------|--|--|
| CMOS                       | 32 bits   | P1 checks D[31:16]<br>P0 checks D[15:0]  | P1 = 0<br>P0 = 1   |
| LVDS <sup>1</sup><br>(DDR) | 32 bits   | [PARP, PARN] rising checks<br>D[15:0]P, D[15:0]N rising<br>[PARP, PARN] falling checks<br>D[15:0]P, D[15:0]N falling | PARP rising = 0<br>PARN rising = 1<br>PARP falling = 1<br>PARN falling = 0 |

<sup>1</sup> "Rising" corresponds to the data sampled on the rising edge of DSC; "falling" corresponds to the data sampled on the falling edge of DSC.

In channelizer mode, where the interface is configurable for different bus widths, data widths, and data formats, the parity bits check the data-word on the bus.

For example, consider a configuration in channelizer mode where the bus width is 4, the data width is 8, and the data format is real. In this case, eight clock cycles are required to transfer all of the baud rate data to represent four channels. In the even parity or odd parity mode, one parity bit and four data bits are sent on each clock; the parity bit checks the four data bits to verify that all of the data was sent over the interface.

Table 74 summarizes the behavior of the two parity pins and how they interact with the data in all interface modes.

**Table 74. Parity Behavior in Channelizer Mode**

| Interface               | Bus Width | Even/Odd Parity  | IQ Parity  |
|-------------------------|-----------|--|--|
| CMOS                    | 4 bits    | P1 ignored<br>P0 checks D[3:0]   | P1 = 0<br>P0 = 1   |
| CMOS                    | 8 bits    | P1 ignored<br>P0 checks D[7:0]   | P1 = 0<br>P0 = 1   |
| CMOS                    | 16 bits   | P1 ignored<br>P0 checks D[15:0]  | P1 = 0<br>P0 = 1   |
| CMOS                    | 32 bits   | P1 checks D[31:16]<br>P0 checks D[15:0]  | P1 = 0<br>P0 = 1   |
| LVDS (SDR) <sup>1</sup> | 4 bits    | [PARP, PARN] falling checks<br>D[3:0]P, D[3:0]N falling  | Not supported  |
| LVDS (SDR) <sup>1</sup> | 8 bits    | [PARP, PARN] falling checks<br>D[7:0]P, D[7:0]N falling  | Not supported  |
| LVDS (SDR) <sup>1</sup> | 16 bits   | [PARP, PARN] falling checks<br>D[15:0]P, D[15:0]N falling  | Not supported  |
| LVDS (DDR) <sup>1</sup> | 32 bits   | [PARP, PARN] rising checks<br>D[15:0]P, D[15:0]N rising<br>[PARP, PARN] falling checks<br>D[15:0]P, D[15:0]N falling | PARP rising = 0<br>PARN rising = 1<br>PARP falling = 1<br>PARN falling = 0 |

<sup>1</sup> "Rising" corresponds to the data sampled on the rising edge of DSC; "falling" corresponds to the data sampled on the falling edge of DSC.

If a parity error occurs, the parity counter (Register 0x02[7:0]) is incremented. The parity counter continues to accumulate until it is cleared or until it reaches a maximum value of 255. The count can be cleared by writing a 1 to Register 0x04[7].

An IRQ can be enabled to trigger when a parity error occurs by writing a 1 to Register 0x03[7]. The status of IRQ can be measured via Register 0x04[7] or by using the IRQ pin (Pin P2). If using the IRQ pin and more than one IRQ is enabled, the user must check Register 0x04 when an IRQ event occurs to determine whether the IRQ was caused by a parity error. The IRQ can also be cleared by writing a 1 to Register 0x04[7].

## ANALOG MODES OF OPERATION

The AD9789 uses a quad-switch architecture that can be configured to operate in one of three modes via the serial peripheral interface: normal mode, RZ mode, and mix mode.

The quad-switch architecture masks the code-dependent glitches that occur in a conventional two-switch DAC. Figure 104 shows the waveforms for a conventional DAC and the quad-switch DAC. In the two-switch architecture with D1 and D2 in different states, a switch transition results in a glitch. However, if D1 and D2 are at the same state, the switch does not create a glitch. This code-dependent glitching causes an increased amount of distortion in the DAC. In the quad-switch architecture, two switches are always transitioning at each half clock cycle, regardless of the code; therefore, code-dependent glitches are eliminated, but a constant glitch at  $2 \times f_{DAC}$  is created.

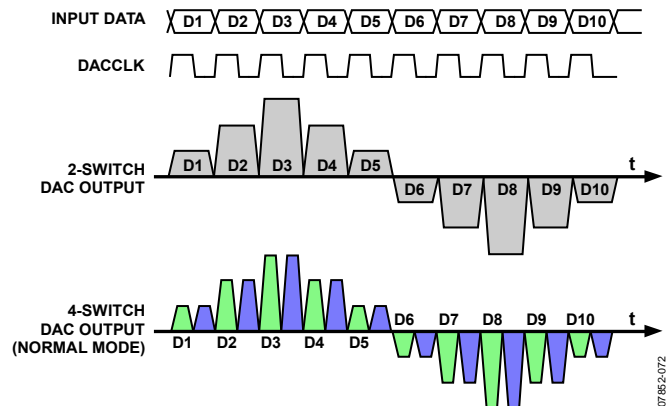

Figure 104. Two-Switch and Quad-Switch DAC Waveforms

The quad-switch architecture can also be easily configured to perform an analog mix or return-to-zero (RZ) function. In mix mode, the output is effectively chopped at the DAC sample rate.

The RZ mode is similar to mix mode, except that the intermediate data samples are replaced with midscale values instead of inverting values. Figure 105 shows the DAC waveforms for both mix mode and RZ mode.

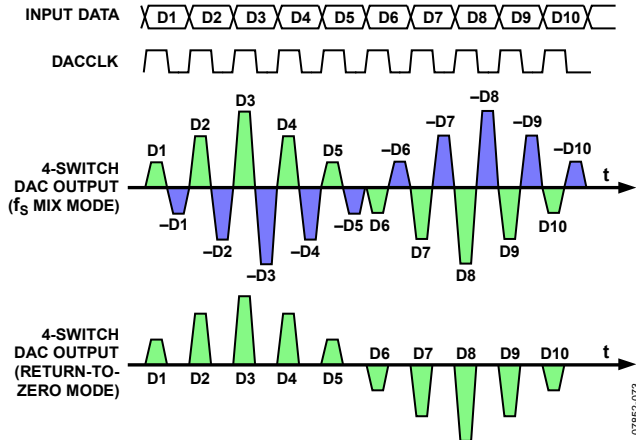

Figure 105. Mix Mode and RZ Mode DAC Waveforms

Switching between analog modes reshapes the sinc roll-off inherent at the DAC output. The performance and maximum amplitude in all three Nyquist zones is affected by this sinc roll-off depending on where the carrier is placed, as shown in Figure 106.

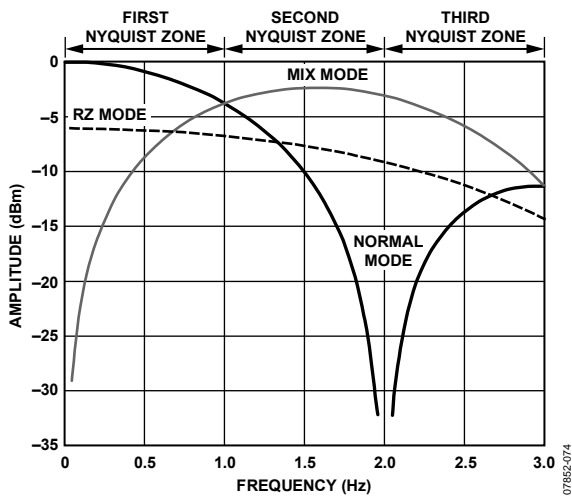

Figure 106. Sinc Roll-Off for Each Analog Operating Mode ( $f_s = 2 \times \text{DACCLK}$ )

The RZ mode, with its lower but flat response, can be quite useful for quick checks of system frequency response.

### ANALOG CONTROL REGISTERS

The AD9789 includes registers for optimizing its analog performance. These registers include noise reduction in the output current mirror and output current mirror headroom adjustments.

#### Mirror Roll-Off Frequency Control

Using the MSEL[1:0] bits (Register 0x36[1:0]), the user can adjust the noise contribution of the internal current mirror to optimize the  $1/f$  noise. Figure 107 shows MSEL vs. the  $1/f$  noise with 20 mA full-scale current into a 50  $\Omega$  resistor.

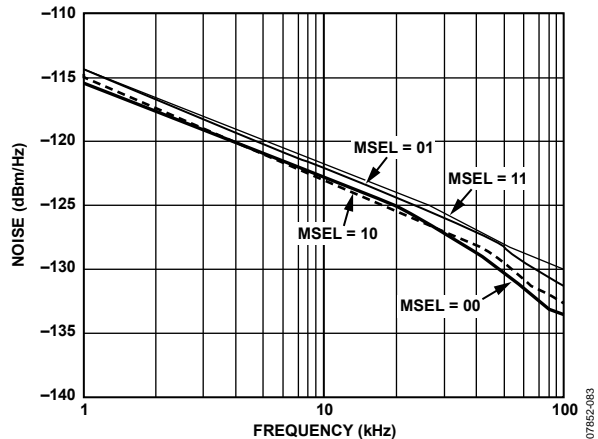

Figure 107.  $1/f$  Noise with Respect to MSEL Bits



# AD9789

## VOLTAGE REFERENCE

The AD9789 output current is set by a combination of digital control bits and the I120 reference current, as shown in Figure 108.

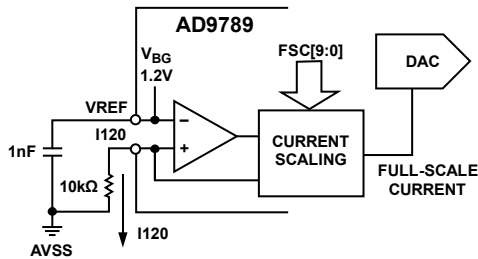

Figure 108. Voltage Reference Circuit

The reference current is obtained by forcing the band gap voltage across an external 10 kΩ resistor from I120 (Pin B14) to ground. The 1.2 V nominal band gap voltage, VREF (Pin C14), generates a 120 μA reference current in the 10 kΩ resistor. This current is adjusted digitally by FSC[7:0] (Register 0x3C[7:0]) and FSC[9:8] (Register 0x3D[1:0]) to set the output full-scale current,  $I_{FS}$ , in milliamperes.

$$I_{FS} = 0.023 \times FSC[9:0] + 8.58$$

The full-scale output current range is approximately 8.6 mA to 32.1 mA for register values from 0x000 to 0x3FF. The default value of 0x200 generates 20 mA full scale. The typical range is shown in Figure 109.

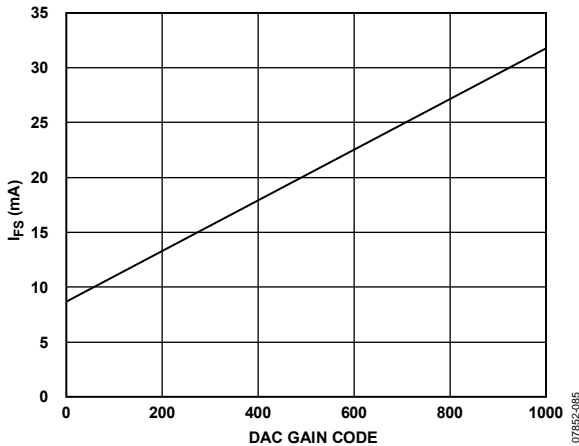

Figure 109. Full-Scale Current vs. DAC Gain Code

Always connect a 10 kΩ resistor from the I120 pin to ground and use the digital controls to adjust the full-scale current. The AD9789 is not a multiplying DAC. Applying an analog signal to I120 is not supported.

VREF (Pin C14) must be bypassed to ground with a 1 nF capacitor. The band gap voltage is present on this pin and can be buffered for use in external circuitry. The typical output impedance is near 5 kΩ. If desired, an external reference can be used to overdrive the internal reference by connecting it to the VREF pin.

IPTAT (Pin D14) is used for factory testing and can simply be left floating. IPTAT is an output current that is proportional to absolute temperature. At 25°C, the output current is approximately 10 μA and follows a slope of approximately 20 nA/°C.

For optimal DOCSIS 3.0 ACLR performance, the full-scale output current settings provided in Table 75 are recommended.

Table 75. Recommended Full-Scale Current Settings vs. Number of QAM Channels

| Number of QAM Channels | Recommended $I_{FS}$ (mA) | FSC[9:0] |
|------------------------|---------------------------|----------|
| 1                      | 20                        | 512      |
| 2                      | 25                        | 720      |
| 3                      | 25                        | 720      |
| 4                      | 25                        | 720      |

## DAC OUTPUT STAGES

To properly evaluate the AD9789 in the lab, three distinct output coupling circuits were used.

Figure 110 shows the optimal output network when measuring traditional DAC performance specifications such as SFDR and IMD performance with sine waves.

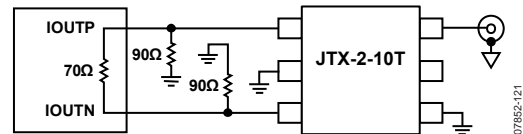

Figure 110. Recommended Transformer Output Stage for Single-Tone/Multitone Measurements

Figure 111 shows the optimal output network when measuring signals in mix mode (second or third Nyquist zone). The bandwidth of the center tap transformer is not sufficient to support mix mode outputs, so the best solution is to use a wideband balun by itself.

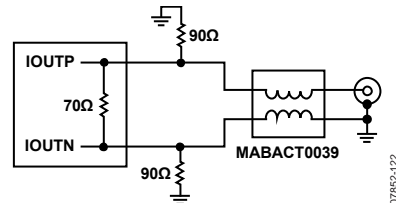

Figure 111. Recommended Transformer Output Stage for Mix Mode

Finally, when measuring performance for CMTS and other digital TV applications, it is advantageous to insert a 1 dB, 1.2 GHz Chebyshev low-pass filter between the DAC and the transformer to better control the impedance seen at the DAC core. This helps to decrease the folded back harmonics for higher frequency outputs. The optimal transformer for CMTS measurements is the JTX-2-10T, which consists of a balun and center-tapped transformer in a single package. This output stage is shown in Figure 112.

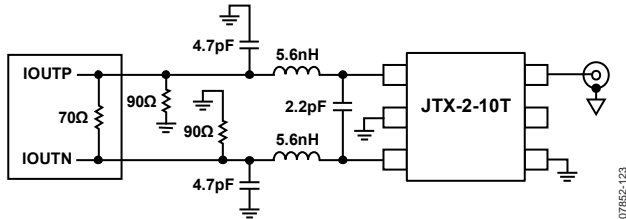

Figure 112. Recommended Transformer Output Stage for CMTS Measurements

Traces from the DAC to the transformer should be 50 Ω impedance to ground each in Figure 110 and Figure 112 and 25 Ω to ground each in Figure 111 to avoid unnecessary parasitics.

### CLOCKING THE AD9789

To provide the required signal swing for the internal clock receiver of the AD9789, it is necessary to use an external clock buffer chip to drive the CLKP and CLKN inputs. These high level, high slew rate signals should not be routed any distance on a PCB. The recommended clock buffer for this application is the ADCLK914. This ultrafast clock buffer is capable of providing 1.9 V out of each side into a 50 Ω load terminated to V<sub>CC</sub> (3.3 V) for a total differential swing of 3.8 V.

The buffer, in turn, can be easily driven from lower level signals such as CML or attenuated PECL that might be encountered on a PCB. This buffer also provides very low, 100 fs added random jitter, which is important to obtain the optimal ac performance from the AD9789. A functional block diagram of the ADCLK914 is shown in Figure 113. Figure 114 shows the recommended schematic for the ADCLK914/AD9789 interface. Refer to the ADCLK914 data sheet for more information. Any time that the noise floor from the DAC cannot meet the specifications in this data sheet, the clock should be examined.

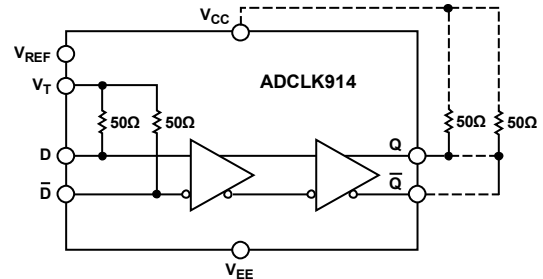

Figure 113. ADCLK914 Functional Block Diagram

The internal 50 Ω resistors shown at the ADCLK914 inputs are rated to carry currents from PECL or CML drivers. The V<sub>T</sub> pin can be connected to V<sub>CC</sub>, a PECL current sink, or the internal V<sub>REF</sub>, or it can be left floating depending on the source. The common-mode input range of the ADCLK914 does not include LVDS voltage levels, so ac coupling is required in that case.

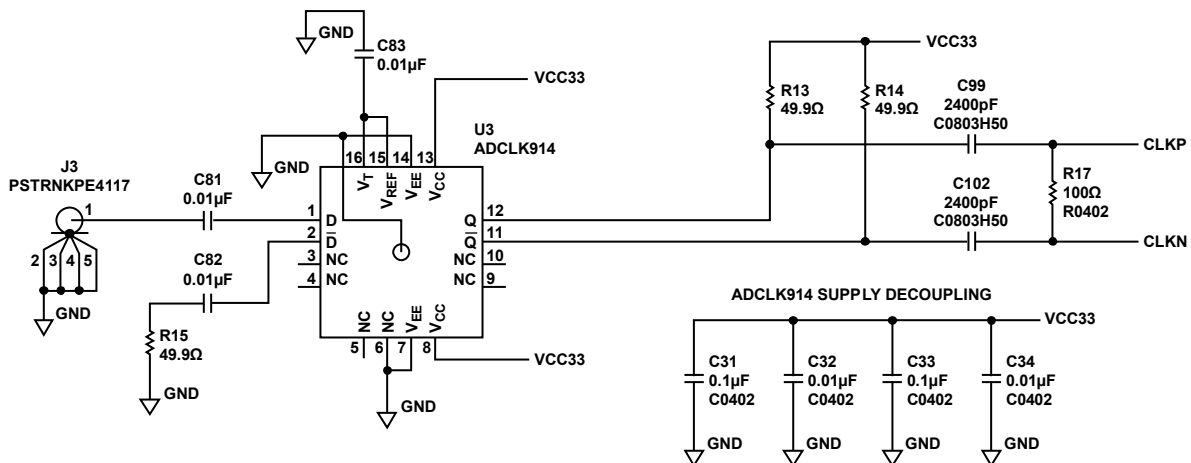

Figure 114. ADCLK914/AD9789 Interface Circuit for Use with a Lab Generator

## Optimizing the Clock Common-Mode Voltage

In addition to the system that optimizes the handoff timing, an additional system sets the common-mode voltage of the clock. This system can be used to properly align the crossing point of the CLKP and CLKN signals to ensure that the duty cycle of the clock is set properly. Figure 115 shows how the common-mode voltage of CLKP and CLKN is set. There are eight switches controlled by the CLKP\_CML bits (Register 0x32[4:1]) and the CLKN\_CML bits (Register 0x31[7:4]) for both the CLKP and CLKN signals. The direction of the adjustment is determined by the PSIGN and NSIGN bits (Register 0x32, Bit 5 and Bit 0). If PSIGN and NSIGN are low, the common-mode voltage decreases with CLKP\_CML/CLKN\_CML values. If PSIGN and NSIGN are high, the common-mode voltage increases with CLKP\_CML/CLKN\_CML values, as shown in Figure 116. With both CLKP\_CML and CLKN\_CML set to 0, the feedback path forces the common-mode voltage to be set to approximately 0.9 V. The optimal ac performance occurs at a setting of -15 on both the CLKP and CLKN offset bits.

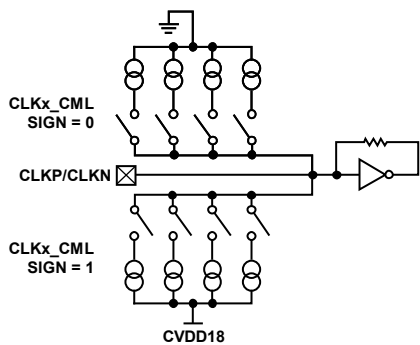

Figure 115. Clock Common-Mode Control

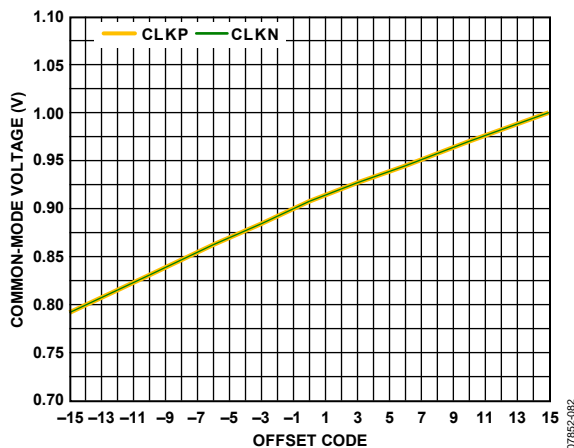

Figure 116. Common-Mode Voltage with Respect to CLKP\_CML/CLKN\_CML and PSIGN/NSIGN

## Clock Phase Noise Effects on AC Performance

The quality of the clock source driving the ADCLK914 determines the achievable ACLR performance of the AD9789. Table 76 summarizes the close-in ACLR for a four-carrier DOCSIS signal at 900 MHz with respect to various phase noise profiles. (All ACLR values are specified in dBc.)

Table 76. Four-Carrier DOCSIS Close-In ACLR Performance at 900 MHz for Various Phase Noise Profiles

| Band             | Phase Noise (dBc) |           |           |           | Spec |
|------------------|-------------------|-----------|-----------|-----------|------|
|                  | Profile 1         | Profile 2 | Profile 3 | Profile 4 |      |
| 750 kHz to 6 MHz | -71               | -67.2     | -62.4     | -59.1     | -60  |
| 6 MHz to 12 MHz  | -70.9             | -70.3     | -67       | -63.8     | -63  |
| 12 MHz to 18 MHz | -71               | -70.8     | -70.8     | -70.8     | -65  |

Table 77 shows the phase noise at various offsets for each profile. (All phase noise numbers are specified in dBc/Hz.)

Table 77. Phase Noise Summary for Each Profile

| Offset <sup>1</sup> | Phase Noise (dBc/Hz) |           |           |           |
|---------------------|----------------------|-----------|-----------|-----------|
|                     | Profile 1            | Profile 2 | Profile 3 | Profile 4 |
| 2 kHz               | -114.8               | -112.8    | -111.7    | -111.2    |
| 20 kHz              | -117.8               | -115.5    | -114.6    | -113.8    |
| 200 kHz             | -128.3               | -118.9    | -118.3    | -116.8    |
| 2 MHz               | -148.5               | -127.9    | -122.2    | -117.9    |
| 20 MHz              | -152.5               | -149.9    | -148      | -145.7    |

<sup>1</sup> At offsets less than 500 kHz, the measurement instrument dominates the phase noise performance.

To meet the close-in ACLR requirements for four-carrier DOCSIS, the phase noise found in Profile 3 is the minimum requirement necessary.

## MU DELAY CONTROLLER

The mu delay adjusts timing between the digital and analog blocks. The mu delay controller receives phase relational information between the digital and analog clock domains. The control system continuously adjusts the mu delay to maintain the desired phase relationship between the digital and analog sections. A top level diagram of the mu delay within the DAC is shown in Figure 117.

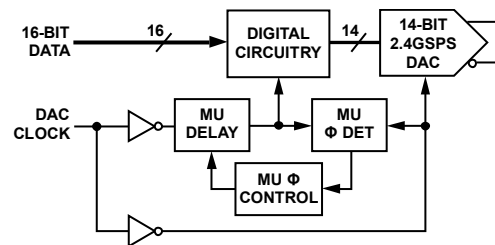

Figure 117. Mu Delay Controller Block Diagram

The mu controller has two modes of operation: initial phase search and phase tracking. In the phase search mode, the controller looks for the initial mu delay value to use before going into tracking mode. In tracking mode, the controller makes adjustments to the initial mu delay value to keep the phase at the desired value. The initial phase search is required because multiple mu delay settings may result in the desired phase, but the device may not operate correctly at all of those mu delay values.

### Operating the Mu Controller in Auto Mode

The mu controller is enabled via Register 0x33[0]. Enabling the controller sets in motion the phase search mode. Before enabling the controller, it is important to turn on both the phase comparator boost (Register 0x3E[5]) and the mu control duty cycle correction circuitry (Register 0x30[7]). Both of these functions allow for more robust operation of the mu controller over the entire operating speed of the part. The three modes of operation for the mu controller are specified by the MODE[1:0] bits in Register 0x33[5:4] as follows:

- Search and track (00) (optimal setting)
- Track only (01)
- Search only (10)

The search algorithm begins at a specified mu delay value set using the MUDLY[8:0] bits, where the LSB is located in Register 0x39[7] and the MSBs are located in Register 0x3A[7:0]. Even though there are nine bits of resolution for this delay line value, the maximum allowable mu delay is 431 (decimal). The optimal point to begin the search is in the middle of the delay line, or approximately 216. The initial search algorithm works by sweeping through different mu delay values until the desired phase is measured; this phase is specified using the MUPHZ[4:0] bits in Register 0x39[4:0], with the maximum allowable phase being 16. If values larger than 16 are loaded, the controller will not lock. When the desired phase is measured, the slope of the phase measurement is calculated and compared to the desired slope, which is specified by the SLOPE bit in Register 0x33[6]. For optimal ac performance, the best setting for the search is a positive slope and a phase value of 14. If the phase and slope match the configured values, the search algorithm is finished. The SEARCH\_TOL bit (Register 0x2F[7]) can be used to specify the accuracy of the search as follows:

- Not exact (0): can find a phase within two values of the desired phase
- Exact (1): finds the exact phase specified (optimal setting)

Figure 118 shows a typical plot of mu phase vs. mu delay line value at 2.4 GSPS. Starting at the selected mu delay value, the search direction can be specified via the SEARCH\_DIR[1:0] bits in Register 0x39[6:5]. The three possible choices for the search are as follows:

- Down only (00)
- Up only (01)
- Alternating up and down (10) (optimal setting)

If the search direction is alternating, the search proceeds in both directions until a programmable guard band is reached in one of the directions, specified by the GUARDBAND[4:0] bits in Register 0x2F[4:0]. When the guard band is reached, the search continues only in the opposite direction. If the desired phase is not found before the guard band is reached in the second direction, the search reverts to the alternating mode and continues looking within the guard band.

The search fails if the mu delay reaches the endpoints. If the controller does not find the desired phase during the search, the TRACK\_ERR bit (Register 0x2F[5]) determines the corrective action as follows:

- Continue (0): continues to search (optimal setting)
- Reset (1)

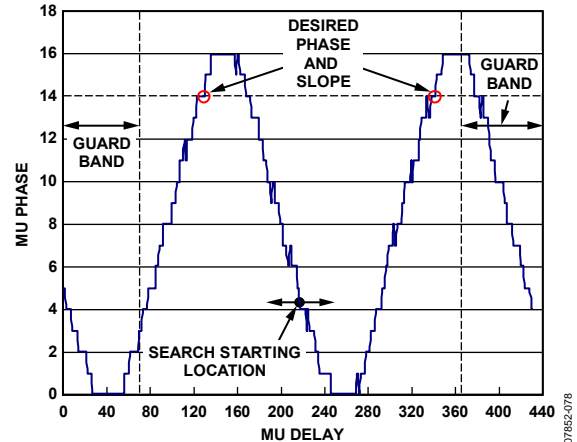

Figure 118. Typical Mu Phase Characteristics @ 2.4 GSPS

To determine whether the search is on the correct slope, the controller measures the slope by first incrementing and then decrementing the mu delay value until any of the following events happens:

- The phase changes by 2.
- The phase is equal to 16 (the maximum value).
- The phase is equal to 0 (the minimum value).
- The mu delay is 431 (the maximum value).
- The mu delay is 0 (the minimum value).

After incrementing and then decrementing the mu delay value, the values of the measured phases are compared to determine whether the slope matches the desired slope. To consider the slope valid, the positive direction phase and the negative direction phase must be on opposite sides of the desired phase. Examples of valid and invalid phase choices are shown in Figure 119 and Figure 120.

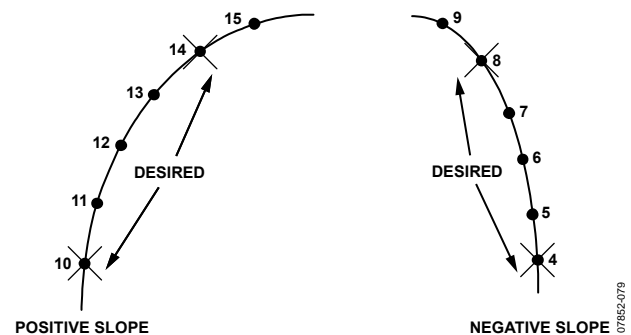

Figure 119. Valid Positive and Negative Slope Phase Examples

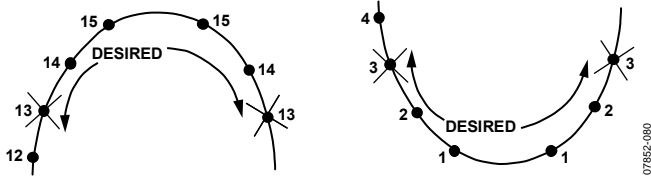

Figure 120. Invalid Slope Phase Examples

When the initial mu delay value has been found by the search algorithm, the tracking mode is enabled. In tracking mode, a simple control loop is used to increment by 1, decrement by 1, or not change the mu delay value depending on the measured phase. The control loop uses the desired slope to determine whether the mu delay should be incremented or decremented. No attempt is made to determine whether the actual slope has changed or is still valid.

Two status bits, LOCKACQ (Register 0x04[3]) and LOCKLOST (Register 0x04[2]) are available to signal proper operation of the control loop. If the current phase is more than five steps away from the desired phase and the LOCKACQ bit was previously set, the LOCKACQ bit is cleared and the LOCKLOST interrupt bit is set. Furthermore, if lock is lost, the controller can remain in the tracking loop, or it can be reset to start the search again.

By setting the MUSAMP bit high (Register 0x33[3]) from a low state, the user can read back the mu delay value that the controller locked to by reading the MUDLY bits (Register 0x39[7] and Register 0x3A[7:0]), as well as the phase it locked to by reading back the MUPHZ[4:0] bits (Register 0x39[4:0]). These bits will no longer read back the value that the search started at or the desired phase, but instead will read back the mu delay line value and phase that the controller is locked to.

Table 78 lists register writes and reads to lock to the controller. The program assumes that the clock receiver is already enabled and that a clean lock is provided. The typical locking time for the mu controller is approximately 180,000 DAC cycles (at 2 GSPS, ~75  $\mu$ s).

Table 78. AD9789 Mu Delay Controller Routine

| Address | Data | R/W   | Description  |
|---------|------|-------|--|
| 0x30    | 0x80 | Write | Enable duty cycle correction.  |
| 0x31    | 0xF0 | Write | Set common-mode level of CLKN: CLKN_CML = 0xF.   |
| 0x32    | 0x9E | Write | Set common-mode level of CLKP: CLKP_CML = 0xF.<br>Set direction of CLKP_CML and CLKN_CML: PSIGN = 0; NSIGN = 0.<br>Enable clock receiver: CLK_DIS = 1. |
| 0x3E    | 0x38 | Write | Set phase comparator boost (AUTO_CAL must be set to its default value, 1).   |
| 0x24    | 0x00 | Write | Enable digital clocks.   |
| 0x24    | 0x80 | Write |  |
| 0x2F    | 0xCE | Write | Search for exact phase with a guard band of 98 codes from endpoints.   |
| 0x33    | 0x42 | Write | Set search slope to positive.  |
| 0x39    | 0x4E | Write | Set search phase to 14, search up and down.  |
| 0x3A    | 0x6C | Write | Set start point of search to mid-point of mu delay line (Code 216).  |
| 0x03    | 0x00 | Write | Disable lock and lock lost indicators.   |
| 0x04    | 0xFE | Write | Clear lock and lock lost indicators.   |
| 0x03    | 0x0C | Write | Enable lock and lock lost indicators.  |
| 0x33    | 0x43 | Write | Enable mu delay controller and start search/track routine.   |
| 0x33    | 0x4B | Write | Set mu phase read bit high.  |
| 0x33    | 0x43 | Write | Set mu phase read bit low.   |
| 0x04    |      | Read  | Check lock and lock lost bits: LOCKACQ should be on. LOCKLOST should be off.   |
| 0x39    |      | Read  | Check phase readback (should be equal to 14).  |

### Operating the Mu Controller in Manual Mode

In manual mode, the user must sweep through all the mu delay values and record the phase value at each value of MUDLY as shown in Figure 118. Every time that the MUDLY value is stepped, the MUSAMP bit must be toggled from low to high to read the corresponding phase for the specified mu delay line value. It is not possible to keep read high and continuously read back the phase value. As with auto mode, the optimal ac performance occurs at a positive slope and a phase of 14; therefore, when the curve is complete, choose the MUDLY value that corresponds to this condition and write that value to the MUDLY[8:0] bits (Register 0x39[7] and Register 0x3A).

### Calculating Mu Delay Line Step Size

Stepping through all of the mu delay line values and plotting mu phase vs. mu delay not only allows the user to find the optimal mu delay value, but can also allow the user to determine the mu delay line step size. To calculate the step size, take one full cycle of the mu phase curve and divide the period of the DAC clock by this delta. From Figure 118, the two transition points are approximately 56 and 270, providing a delta of approximately 214 steps. Therefore, the mu delay line step size would be approximately 2 ps/step, as shown in the following equation:

$$\frac{\left( \frac{1}{2.4 \text{ GHz}} \right)}{214} = 1.95 \text{ ps}$$

If the mu controller is enabled, this value allows the user to calculate (in picoseconds) how much drift is in their system with respect to the DAC clock period over temperature.

### INTERRUPT REQUESTS

The following interrupt (IRQ) requests can be used for additional information and verification of the status of various functional blocks:

- PARERR—triggered when one or more parity errors occurs on the data bus
- PARMSET—triggered when PARMNEW is set and internally registered
- PARMCLR—triggered when PARMNEW is cleared and internally registered
- LOCKACQ—triggered when the mu controller is locked to the user-defined phase
- LOCKLOST—triggered when the mu controller loses lock (if the LOCKACQ bit was previously set)
- SATERR—triggered when one or more saturation errors occurs

Each IRQ is enabled using the enable bits in the interrupt enable register, Register 0x03. The status of the IRQ can be measured in one of the following ways: via the SPI bits found in the interrupt status/clear register (Register 0x04) or using the IRQ pin (Pin P2).

If the pin is used to determine that an interrupt has occurred, it is necessary to check Register 0x04 to determine which bit caused the interrupt because the pin indicates only that an interrupt has occurred. To clear an IRQ, it is necessary to write a 1 to the bit in Register 0x04 that corresponds to the interrupt.

# AD9789

## RECOMMENDED START-UP SEQUENCE

The steps necessary to optimize the performance of the part and generate an output waveform are listed in Table 79.

**Table 79. Recommended System Start-Up Sequence**

| Step | Description  | Register     | Data |
|------|--|--------------|------|
| 0    | Power up the AD9789.   |              |      |
| 0    | Apply the clock.   |              |      |
| 1    | Enable the clock receiver and set the clock CML.                   | 0x32         | 0x9E |
| 1    | Enable duty cycle correction.                                      | 0x30         | 0x80 |
| 2    | Enable digital clocks.   | 0x24         | 0x00 |
| 3    |  | 0x24         | 0x80 |
| 4    | Set up mu controller.  | 0x2F         | 0xCE |
| 4    |  | 0x33         | 0x42 |
| 4    |  | 0x39         | 0x4E |
| 4    |  | 0x3A         | 0x6C |
| 5    | Disable all interrupts.  | 0x03         | 0x00 |
| 6    | Clear all interrupts.  | 0x04         | 0xFE |
| 7    | Enable mu control interrupts.                                      | 0x03         | 0x0C |
| 8    | Enable mu delay controller.  | 0x33         | 0x43 |
| 9    | Set up digital datapath.   | 0x06 to 0x15 |      |
| 9    | Set up rate converter.   | 0x16 to 0x1B |      |
| 9    | Set up BPF center frequency.                                       | 0x1C to 0x1D |      |
| 9    | Set up interface.  | 0x20 to 0x23 |      |
| 9    | Set up channel gains.  | 0x25 to 0x28 |      |
| 9    | Set up spectral invert.  | 0x29         |      |
| 9    | Set up full-scale current.   | 0x3C to 0x3D |      |
| 10   | Wait until mu delay controller is locked (SPI read) <sup>1</sup> . | 0x04         | 0x08 |
| 11   | Update rate converter and BPF.                                     | 0x1E         | 0x80 |
| 12   | Update interface clocks.   | 0x24         | 0x00 |
| 13   |  | 0x24         | 0x80 |
| 14   | Enable channels.   | 0x05         |      |
| 15   | Enable other interrupts if desired.                                | 0x03         |      |

<sup>1</sup> Typical lock time of the mu controller is approximately 180,000 DAC cycles (at 2 GSPS, ~75  $\mu$ s).

## CUSTOMER BIST MODES

### USING THE INTERNAL PRN GENERATOR TO TEST QAM OUTPUT AC PERFORMANCE

The AD9789 can be configured to enable an on-chip pseudo-random number (PRN) generator. The PRN output is connected to the front end of the datapath and disconnects the datapath from the input pins. In this way, the PRN generator can be used in conjunction with the on-chip QAM encoder to generate a QAM output. The PRN generator allows the user to measure the ac performance of a QAM signal at the DAC output without an external data source. To enable the internal PRN generator via the serial port, follow these steps.

1. Ensure that the clock is enabled and that the clock common-mode level is set to its optimal value by setting the registers in Table 80 to the values shown in the table.

**Table 80. Register Settings to Configure the Clock**

| Register | Data | Description   |
|----------|------|---|
| 0x30     | 0x80 | Enable duty cycle correction.   |
| 0x31     | 0xF0 | Set the common-mode level of CLKN:<br>CLKN_CML = 0xF.   |
| 0x32     | 0x9E | Set the common-mode level of CLKP:<br>CLKP_CML = 0xF. Set PSIGN = 0, NSIGN = 0.<br>Enable clock receiver (CLK_DIS = 1). |

2. Configure BIST mode for PRN generation and disconnect the inputs by setting the registers in Table 81 to the values shown in the table.

**Table 81. Register Settings to Configure PRN Generation**

| Register | Setting |
|----------|---------|
| 0x42     | 0x10    |
| 0x43     | 0x00    |
| 0x44     | 0x10    |
| 0x45     | 0x00    |
| 0x46     | 0x00    |
| 0x47     | 0x10    |
| 0x49     | 0x16    |
| 0x4B     | 0x17    |
| 0x4C     | 0x4E    |
| 0x4D     | 0x1F    |
| 0x05     | 0x0F    |

3. Cycle the PARMNEW bit to ensure that the digital clocks are active by first setting Register 0x24 to 0x00, and then setting Register 0x24 to 0x80.
4. Start PRN generation by setting the registers in Table 82 to the values shown in the table.

**Table 82. Register Settings to Start PRN Generation**

| Register | Setting |
|----------|---------|
| 0x48     | 0xAB    |
| 0x4A     | 0xAB    |
| 0x40     | 0x56    |

After the PRN generator is started, users can freely configure the datapath for their desired test configuration as long as Register 0x40 to Register 0x55 are not modified.

To disable the PRN generator, write 0x00 to Register 0x40.

### USING THE INTERNAL BUILT-IN SELF-TEST (BIST) TO TEST FOR DIGITAL DATA INPUT CONNECTIVITY

The AD9789 includes an internal built-in self-test (BIST) engine that processes incoming data and creates a signature that can be read back via the serial port. This BIST feature can be configured to observe the static state of the digital data input pins (L4 to L12, M4 to M12, N5 to N12, and P5 to P12) and to reflect the state of these pins via the signature registers (Register 0x50 to Register 0x55). In this way, the user can verify digital data input connectivity.

#### Testing Connectivity for LVDS Interface Mode

To test the connectivity of the digital data input pins in LVDS interface mode, follow these steps.

1. Ensure that the clock is enabled and that the clock common-mode level is set to its optimal value by setting the registers in Table 83 to the values shown in the table.

**Table 83. Register Settings to Configure the Clock**

| Register | Data | Description   |
|----------|------|---|
| 0x30     | 0x80 | Enable duty cycle correction.   |
| 0x31     | 0xF0 | Set the common-mode level of CLKN:<br>CLKN_CML = 0xF.   |
| 0x32     | 0x9E | Set the common-mode level of CLKP:<br>CLKP_CML = 0xF. Set PSIGN = 0, NSIGN = 0.<br>Enable clock receiver (CLK_DIS = 1). |

2. Cycle the PARMNEW bit to ensure that the digital clocks are active by first setting Register 0x24 to 0x00, and then setting Register 0x24 to 0x80.
3. Configure the LVDS interface for high speed, 16-bit bus width, 16-bit data width operation by setting the registers in Table 84 to the values shown in the table.

**Table 84. Register Settings for LVDS Interface**

| Register | Setting |
|----------|---------|
| 0x20     | 0x08    |
| 0x21     | 0x41    |
| 0x22     | 0x1F    |
| 0x23     | 0x87    |



- Configure pin mode by setting the registers in Table 85 to the values shown in the table.

**Table 85. Register Settings to Configure Pin Modes**

| Register | Setting |
|----------|---------|
| 0x42     | 0x00    |
| 0x43     | 0x08    |
| 0x44     | 0x00    |
| 0x45     | 0x08    |
| 0x46     | 0x00    |
| 0x47     | 0x10    |
| 0x49     | 0x1C    |
| 0x4B     | 0x1C    |
| 0x4C     | 0x00    |
| 0x4D     | 0x00    |

- Cycle the PARMNEW bit to ensure that the interface configuration was updated by first setting Register 0x24 to 0x00, and then setting Register 0x24 to 0x80.
- Apply static LVDS data to the input ports.
- Enable the BIST pin test by setting the registers in Table 86 to the values shown in the table.

**Table 86. Register Settings for BIST Pin Test**

| Register | Setting |
|----------|---------|
| 0x48     | 0x80    |
| 0x4A     | 0x80    |
| 0x40     | 0x55    |

- Read back the signature registers (Register 0x50 to Register 0x55) to determine the pin states (see Table 87).

**Table 87. Signature Register Settings**

| Register | Associated LVDS Pairs        |
|----------|------------------------------|
| 0x50     | Data bits D[7:0]             |
| 0x51     | Data bits D[15:8]            |
| 0x52     | Parity PAR                   |
| 0x53     | Data bits D[7:0] (repeated)  |
| 0x54     | Data bits D[15:8] (repeated) |
| 0x55     | Parity PAR (repeated)        |

### Testing Connectivity for CMOS Interface Mode

To test the connectivity of the digital data input pins in CMOS interface mode, follow these steps.

- Ensure that the clock is enabled and that the clock common-mode level is set to its optimal value by setting the registers in Table 88 to the values shown in the table.

**Table 88. Register Settings to Configure the Clock**

| Register | Data | Description   |
|----------|------|---|
| 0x30     | 0x80 | Enable duty cycle correction.   |
| 0x31     | 0xF0 | Set the common-mode level of CLKN: CLKN_CML = 0xF.  |
| 0x32     | 0x9E | Set the common-mode level of CLKP: CLKP_CML = 0xF. Set PSIGN = 0, NSIGN = 0. Enable clock receiver (CLK_DIS = 1). |

- Cycle the PARMNEW bit to ensure that the digital clocks are active by first setting Register 0x24 to 0x00, and then setting Register 0x24 to 0x80.
- Configure the CMOS interface for high speed, 32-bit bus width, 16-bit data width operation by setting the registers in Table 89 to the values shown in the table.

**Table 89. Register Settings for CMOS Interface**

| Register | Setting |
|----------|---------|
| 0x20     | 0x08    |
| 0x21     | 0x61    |
| 0x22     | 0x1F    |
| 0x23     | 0x87    |

- Configure pin mode by setting the registers in Table 90 to the values shown in the table.

**Table 90. Register Settings to Configure Pin Modes**

| Register | Setting |
|----------|---------|
| 0x42     | 0x00    |
| 0x43     | 0x08    |
| 0x44     | 0x00    |
| 0x45     | 0x08    |
| 0x46     | 0x00    |
| 0x47     | 0x10    |
| 0x49     | 0x1C    |
| 0x4B     | 0x1C    |
| 0x4C     | 0x00    |
| 0x4D     | 0x00    |

- Cycle the PARMNEW bit to ensure that the interface configuration was updated by first setting Register 0x24 to 0x00, and then setting Register 0x24 to 0x80.
- Apply static CMOS data to the input ports.
- Enable the BIST pin test by setting the registers in Table 91 to the values shown in the table.

**Table 91. Register Settings for BIST Pin Test**

| Register | Setting |
|----------|---------|
| 0x48     | 0x80    |
| 0x4A     | 0x80    |
| 0x40     | 0x55    |

- Read back the signature registers (Register 0x50 to Register 0x55) to determine the pin states (see Table 92).

**Table 92. Signature Register Settings**

| Register | Associated CMOS Pairs |
|----------|-----------------------|
| 0x50     | Data bits D[23:16]    |
| 0x51     | Data bits D[31:24]    |
| 0x52     | Parity P1             |
| 0x53     | Data bits D[7:0]      |
| 0x54     | Data bits [D15:8]     |
| 0x55     | Parity P0             |

# QAM CONSTELLATION MAPS

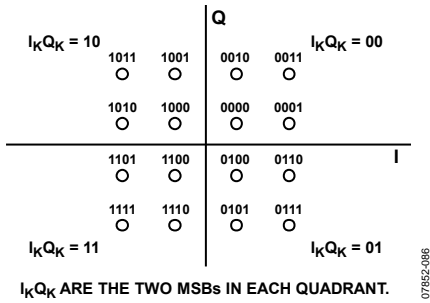

Figure 121. DVB-C 16-QAM Constellation

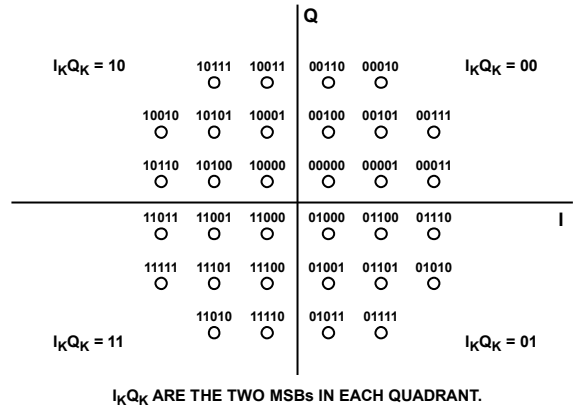

Figure 123. DVB-C 32-QAM Constellation

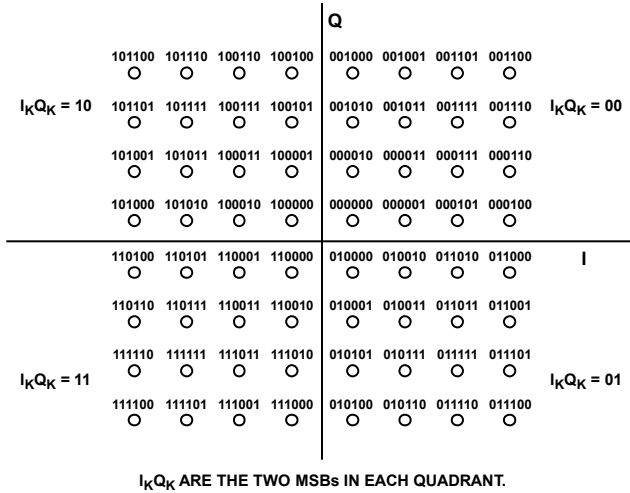

Figure 122. DVB-C 64-QAM Constellation

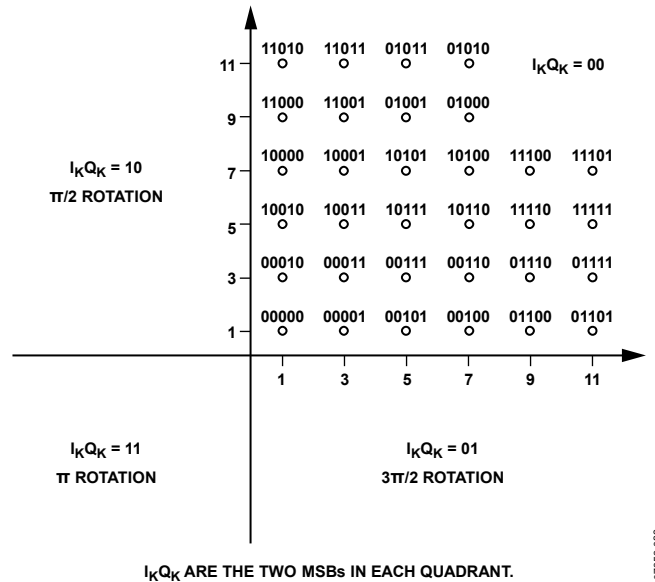
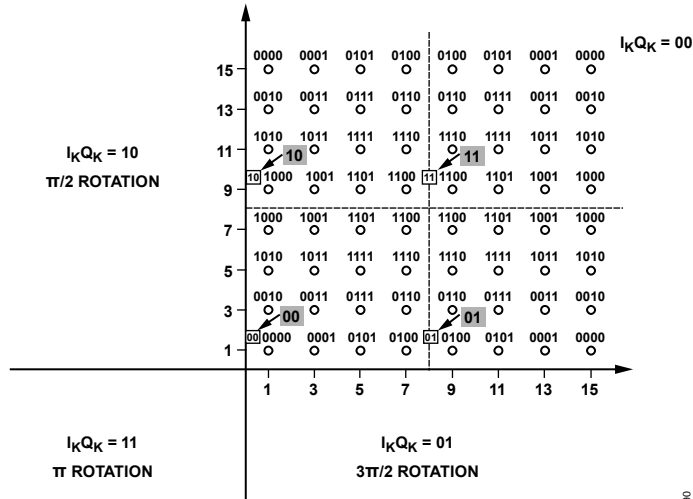

Figure 124. DVB-C 128-QAM Constellation



$I_K Q_K$  ARE THE TWO MSBs IN EACH QUADRANT.

Figure 125. DVB-C 256-QAM Constellation

07852-080

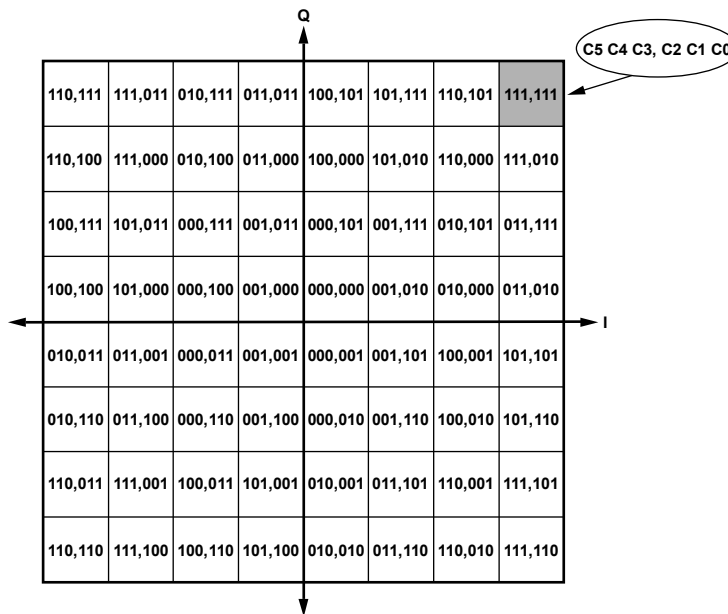

Figure 126. DOCSIS 64-QAM Constellation

07852-081

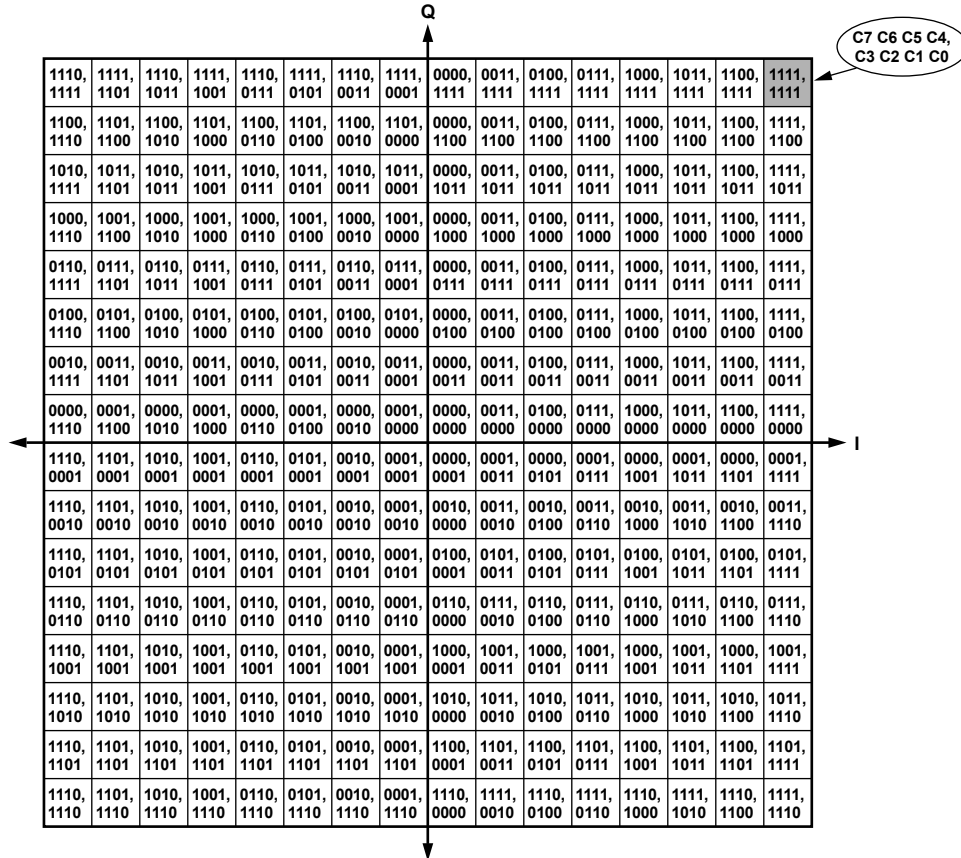

Figure 127. DOCSIS 256-QAM Constellation

07862-126

## CHANNELIZER MODE PIN MAPPING FOR CMOS AND LVDS

Table 93 lists the available combinations of data input configuration parameters when the AD9789 is in channelizer mode. Many of these configurations require multiple clocks to load all channels. All of these configurations are described in detail in Table 96 and Table 97.

Table 94 and Table 95, along with Figure 128 and Figure 129, describe CMOS and LVDS data input pin mapping. CMOS mode is always single data rate and samples on the rising edge of DSC. LVDS mode is single data rate (SDR) for bus widths of 4 bits through 16 bits and double data rate (DDR) for a bus width of 32 bits.

**Table 93. Data Input Configurations for Channelizer Mode**

| Bus Width | Data Width | Data Format |
|-----------|------------|-------------|
| 4         | 8          | Real        |
| 4         | 8          | Complex     |
| 8         | 8          | Real        |
| 8         | 8          | Complex     |
| 8         | 16         | Complex     |
| 16        | 8          | Real        |
| 16        | 8          | Complex     |
| 16        | 16         | Complex     |
| 32        | 8          | Real        |
| 32        | 8          | Complex     |
| 32        | 16         | Complex     |

**Table 94. CMOS Pin Assignments for Various Interface Widths**

| Interface Width | Pin Assignments | BUSWIDTH[1:0] |
|-----------------|-----------------|---------------|
| 4 bits          | D[3:0]          | 00            |
| 8 bits          | D[7:0]          | 01            |
| 16 bits         | D[15:0]         | 10            |
| 32 bits         | D[31:0]         | 11            |

**Table 95. LVDS Pin Assignments for Various Interface Widths**

| Interface Width | Pin Assignments                                 | BUSWIDTH[1:0] |
|-----------------|---|---------------|
| 4 bits          | D[3:0]P, D[3:0]N                                | 00            |
| 8 bits          | D[7:0]P, D[7:0]N                                | 01            |
| 16 bits         | D[15:0]P, D[15:0]N                              | 10            |
| 32 bits         | D[15:0]P, D[15:0]N rising edge and falling edge | 11            |

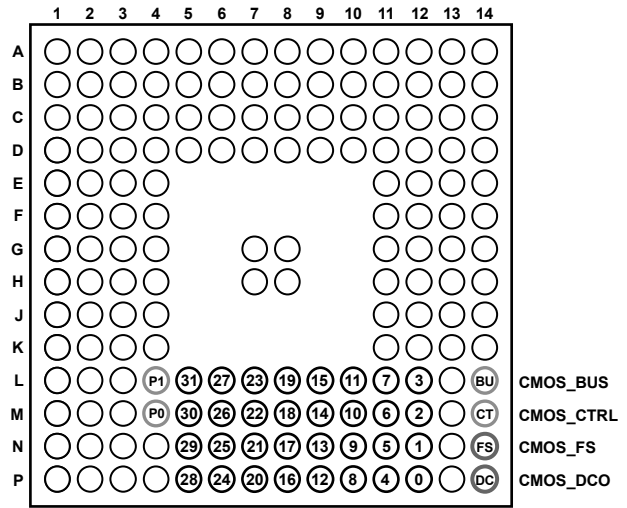

Figure 128. CMOS Data Input Pin Mapping

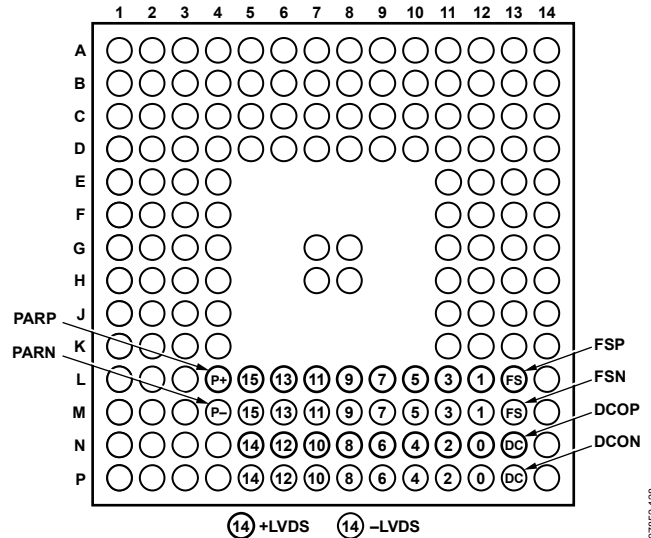

Figure 129. LVDS Data Input Pin Mapping

In Table 96, “R” represents real data loaded to a given channel, “I” represents the in-phase term, and “Q” represents the quadrature term of complex data. The channel number follows R, I, or Q.

**Table 96. Channelizer Mode Configurations and Channel Construction: CMOS Interface, Channel Prioritization = 1**

| Datapath Configuration |    |         | CMOS Pin Mapping |           |           |           |           |           |          |         |         |    |    |    |
|------------------------|----|---------|------------------|-----------|-----------|-----------|-----------|-----------|----------|---------|---------|----|----|----|
| BW                     | DW | Format  | DCO              | [D31:D28] | [D27:D24] | [D23:D20] | [D19:D16] | [D15:D12] | [D11:D8] | [D7:D4] | [D3:D0] |    |    |    |
| 4                      | 8  | Real    | 1                |           |           |           |           |           |          |         | R0      |    |    |    |
|                        |    |         | 2                |           |           |           |           |           |          |         | R0      |    |    |    |
|                        |    |         | 3                |           |           |           |           |           |          |         |         | R1 |    |    |
|                        |    |         | 4                |           |           |           |           |           |          |         |         | R1 |    |    |
|                        |    |         | 5                |           |           |           |           |           |          |         |         | R2 |    |    |
|                        |    |         | 6                |           |           |           |           |           |          |         |         | R2 |    |    |
|                        |    |         | 7                |           |           |           |           |           |          |         |         |    | R3 |    |
|                        |    |         | 8                |           |           |           |           |           |          |         |         |    | R3 |    |
| Datapath Configuration |    |         | CMOS Pin Mapping |           |           |           |           |           |          |         |         |    |    |    |
| BW                     | DW | Format  | DCO              | [D31:D28] | [D27:D24] | [D23:D20] | [D19:D16] | [D15:D12] | [D11:D8] | [D7:D4] | [D3:D0] |    |    |    |
| 4                      | 8  | Complex | 1                |           |           |           |           |           |          |         |         | I0 |    |    |
|                        |    |         | 2                |           |           |           |           |           |          |         |         | I0 |    |    |
|                        |    |         | 3                |           |           |           |           |           |          |         |         |    | Q0 |    |
|                        |    |         | 4                |           |           |           |           |           |          |         |         |    | Q0 |    |
|                        |    |         | 5                |           |           |           |           |           |          |         |         |    | I1 |    |
|                        |    |         | 6                |           |           |           |           |           |          |         |         |    | I1 |    |
|                        |    |         | 7                |           |           |           |           |           |          |         |         |    | Q1 |    |
|                        |    |         | 8                |           |           |           |           |           |          |         |         |    | Q1 |    |
|                        |    |         | 9                |           |           |           |           |           |          |         |         |    |    | I2 |
|                        |    |         | 10               |           |           |           |           |           |          |         |         |    |    | I2 |
|                        |    |         | 11               |           |           |           |           |           |          |         |         |    |    | Q2 |
|                        |    |         | 12               |           |           |           |           |           |          |         |         |    |    | Q2 |
|                        |    |         | 13               |           |           |           |           |           |          |         |         |    |    | I3 |
|                        |    |         | 14               |           |           |           |           |           |          |         |         |    |    | I3 |
|                        |    |         | 15               |           |           |           |           |           |          |         |         |    |    | Q3 |
|                        |    |         | 16               |           |           |           |           |           |          |         |         |    |    | Q3 |
| Datapath Configuration |    |         | CMOS Pin Mapping |           |           |           |           |           |          |         |         |    |    |    |
| BW                     | DW | Format  | DCO              | [D31:D28] | [D27:D24] | [D23:D20] | [D19:D16] | [D15:D12] | [D11:D8] | [D7:D4] | [D3:D0] |    |    |    |
| 8                      | 8  | Real    | 1                |           |           |           |           |           |          |         |         | R0 |    |    |
|                        |    |         | 2                |           |           |           |           |           |          |         |         | R1 |    |    |
|                        |    |         | 3                |           |           |           |           |           |          |         |         |    | R2 |    |
|                        |    |         | 4                |           |           |           |           |           |          |         |         |    | R3 |    |
| Datapath Configuration |    |         | CMOS Pin Mapping |           |           |           |           |           |          |         |         |    |    |    |
| BW                     | DW | Format  | DCO              | [D31:D28] | [D27:D24] | [D23:D20] | [D19:D16] | [D15:D12] | [D11:D8] | [D7:D4] | [D3:D0] |    |    |    |
| 8                      | 8  | Complex | 1                |           |           |           |           |           |          |         |         | I0 |    |    |
|                        |    |         | 2                |           |           |           |           |           |          |         |         | Q0 |    |    |
|                        |    |         | 3                |           |           |           |           |           |          |         |         |    | I1 |    |
|                        |    |         | 4                |           |           |           |           |           |          |         |         |    | Q1 |    |
|                        |    |         | 5                |           |           |           |           |           |          |         |         |    | I2 |    |
|                        |    |         | 6                |           |           |           |           |           |          |         |         |    | Q2 |    |
|                        |    |         | 7                |           |           |           |           |           |          |         |         |    | I3 |    |
|                        |    |         | 8                |           |           |           |           |           |          |         |         |    | Q3 |    |

# AD9789

| Datapath Configuration |    |         | CMOS Pin Mapping |           |           |           |           |           |          |         |         |    |    |
|------------------------|----|---------|------------------|-----------|-----------|-----------|-----------|-----------|----------|---------|---------|----|----|
| BW                     | DW | Format  | DCO              | [D31:D28] | [D27:D24] | [D23:D20] | [D19:D16] | [D15:D12] | [D11:D8] | [D7:D4] | [D3:D0] |    |    |
| 8                      | 16 | Complex | 1                |           |           |           |           |           |          |         | I0      |    |    |
|                        |    |         | 2                |           |           |           |           |           |          |         | I0      |    |    |
|                        |    |         | 3                |           |           |           |           |           |          |         |         | Q0 |    |
|                        |    |         | 4                |           |           |           |           |           |          |         |         | Q0 |    |
|                        |    |         | 5                |           |           |           |           |           |          |         |         | I1 |    |
|                        |    |         | 6                |           |           |           |           |           |          |         |         | I1 |    |
|                        |    |         | 7                |           |           |           |           |           |          |         |         |    | Q1 |
|                        |    |         | 8                |           |           |           |           |           |          |         |         |    | Q1 |
|                        |    |         | 9                |           |           |           |           |           |          |         |         |    | I2 |
|                        |    |         | 10               |           |           |           |           |           |          |         |         |    | I2 |
|                        |    |         | 11               |           |           |           |           |           |          |         |         |    | Q2 |
|                        |    |         | 12               |           |           |           |           |           |          |         |         |    | Q2 |
|                        |    |         | 13               |           |           |           |           |           |          |         |         |    | I3 |
|                        |    |         | 14               |           |           |           |           |           |          |         |         |    | I3 |
|                        |    |         | 15               |           |           |           |           |           |          |         |         |    | Q3 |
|                        |    |         | 16               |           |           |           |           |           |          |         |         |    | Q3 |
| Datapath Configuration |    |         | CMOS Pin Mapping |           |           |           |           |           |          |         |         |    |    |
| BW                     | DW | Format  | DCO              | [D31:D28] | [D27:D24] | [D23:D20] | [D19:D16] | [D15:D12] | [D11:D8] | [D7:D4] | [D3:D0] |    |    |
| 16                     | 8  | Real    | 1                |           |           |           |           |           | R1       |         | R0      |    |    |
|                        |    |         | 2                |           |           |           |           |           | R3       |         | R2      |    |    |
| Datapath Configuration |    |         | CMOS Pin Mapping |           |           |           |           |           |          |         |         |    |    |
| BW                     | DW | Format  | DCO              | [D31:D28] | [D27:D24] | [D23:D20] | [D19:D16] | [D15:D12] | [D11:D8] | [D7:D4] | [D3:D0] |    |    |
| 16                     | 8  | Complex | 1                |           |           |           |           |           | Q0       |         | I0      |    |    |
|                        |    |         | 2                |           |           |           |           |           | Q1       |         | I1      |    |    |
|                        |    |         | 3                |           |           |           |           |           | Q2       |         | I2      |    |    |
|                        |    |         | 4                |           |           |           |           |           | Q3       |         | I3      |    |    |
| Datapath Configuration |    |         | CMOS Pin Mapping |           |           |           |           |           |          |         |         |    |    |
| BW                     | DW | Format  | DCO              | [D31:D28] | [D27:D24] | [D23:D20] | [D19:D16] | [D15:D12] | [D11:D8] | [D7:D4] | [D3:D0] |    |    |
| 16                     | 16 | Complex | 1                |           |           |           |           |           |          |         | I0      |    |    |
|                        |    |         | 2                |           |           |           |           |           |          |         | Q0      |    |    |
|                        |    |         | 3                |           |           |           |           |           |          |         | I1      |    |    |
|                        |    |         | 4                |           |           |           |           |           |          |         | Q1      |    |    |
|                        |    |         | 5                |           |           |           |           |           |          |         | I2      |    |    |
|                        |    |         | 6                |           |           |           |           |           |          |         | Q2      |    |    |
|                        |    |         | 7                |           |           |           |           |           |          |         | I3      |    |    |
|                        |    |         | 8                |           |           |           |           |           |          |         | Q3      |    |    |
| Datapath Configuration |    |         | CMOS Pin Mapping |           |           |           |           |           |          |         |         |    |    |
| BW                     | DW | Format  | DCO              | [D31:D28] | [D27:D24] | [D23:D20] | [D19:D16] | [D15:D12] | [D11:D8] | [D7:D4] | [D3:D0] |    |    |
| 32                     | 8  | Real    | 1                |           | R3        |           | R2        |           | R1       |         | R0      |    |    |
| Datapath Configuration |    |         | CMOS Pin Mapping |           |           |           |           |           |          |         |         |    |    |
| BW                     | DW | Format  | DCO              | [D31:D28] | [D27:D24] | [D23:D20] | [D19:D16] | [D15:D12] | [D11:D8] | [D7:D4] | [D3:D0] |    |    |
| 32                     | 8  | Complex | 1                |           | Q1        |           | I1        |           | Q0       |         | I0      |    |    |
|                        |    |         | 2                |           | Q3        |           | I3        |           | Q2       |         | I2      |    |    |
| Datapath Configuration |    |         | CMOS Pin Mapping |           |           |           |           |           |          |         |         |    |    |
| BW                     | DW | Format  | DCO              | [D31:D28] | [D27:D24] | [D23:D20] | [D19:D16] | [D15:D12] | [D11:D8] | [D7:D4] | [D3:D0] |    |    |
| 32                     | 16 | Complex | 1                |           |           |           |           |           |          |         | I0      |    |    |
|                        |    |         | 2                |           |           |           |           |           |          |         | I1      |    |    |
|                        |    |         | 3                |           |           |           |           |           |          |         | I2      |    |    |
|                        |    |         | 4                |           |           |           |           |           |          |         | I3      |    |    |

In DDR mode, “rise” corresponds to data sampled on the rising edge of DSC; “fall” corresponds to data sampled on the falling edge of DSC.

**Table 97. Channelizer Mode Configurations and Channel Construction: LVDS Interface, Channel Prioritization = 1**

| Datapath Configuration |    |         | LVDS Pin Mapping |           |          |         |         |
|------------------------|----|---------|------------------|-----------|----------|---------|---------|
| BW                     | DW | Format  | DCO              | [D15:D12] | [D11:D8] | [D7:D4] | [D3:D0] |
| 4                      | 8  | Real    | 1                |           |          |         | R0      |
|                        |    |         | 2                |           |          |         | R0      |
|                        |    |         | 3                |           |          |         | R1      |
|                        |    |         | 4                |           |          |         | R1      |
|                        |    |         | 5                |           |          |         | R2      |
|                        |    |         | 6                |           |          |         | R2      |
|                        |    |         | 7                |           |          |         | R3      |
|                        |    |         | 8                |           |          |         | R3      |
| Datapath Configuration |    |         | LVDS Pin Mapping |           |          |         |         |
| BW                     | DW | Format  | DCO              | [D15:D12] | [D11:D8] | [D7:D4] | [D3:D0] |
| 4                      | 8  | Complex | 1                |           |          |         | I0      |
|                        |    |         | 2                |           |          |         | I0      |
|                        |    |         | 3                |           |          |         | Q0      |
|                        |    |         | 4                |           |          |         | Q0      |
|                        |    |         | 5                |           |          |         | I1      |
|                        |    |         | 6                |           |          |         | I1      |
|                        |    |         | 7                |           |          |         | Q1      |
|                        |    |         | 8                |           |          |         | Q1      |
|                        |    |         | 9                |           |          |         | I2      |
|                        |    |         | 10               |           |          |         | I2      |
|                        |    |         | 11               |           |          |         | Q2      |
|                        |    |         | 12               |           |          |         | Q2      |
|                        |    |         | 13               |           |          |         | I3      |
|                        |    |         | 14               |           |          |         | I3      |
|                        |    |         | 15               |           |          |         | Q3      |
|                        |    |         | 16               |           |          |         | Q3      |
| Datapath Configuration |    |         | LVDS Pin Mapping |           |          |         |         |
| BW                     | DW | Format  | DCO              | [D15:D12] | [D11:D8] | [D7:D4] | [D3:D0] |
| 8                      | 8  | Real    | 1                |           |          |         | R0      |
|                        |    |         | 2                |           |          |         | R1      |
|                        |    |         | 3                |           |          |         | R2      |
|                        |    |         | 4                |           |          |         | R3      |
| Datapath Configuration |    |         | LVDS Pin Mapping |           |          |         |         |
| BW                     | DW | Format  | DCO              | [D15:D12] | [D11:D8] | [D7:D4] | [D3:D0] |
| 8                      | 8  | Complex | 1                |           |          |         | I0      |
|                        |    |         | 2                |           |          |         | Q0      |
|                        |    |         | 3                |           |          |         | I1      |
|                        |    |         | 4                |           |          |         | Q1      |
|                        |    |         | 5                |           |          |         | I2      |
|                        |    |         | 6                |           |          |         | Q2      |
|                        |    |         | 7                |           |          |         | I3      |
|                        |    |         | 8                |           |          |         | Q3      |



# AD9789

| Datapath Configuration |    |         | LVDS Pin Mapping |           |          |         |         |
|------------------------|----|---------|------------------|-----------|----------|---------|---------|
| BW                     | DW | Format  | DCO              | [D15:D12] | [D11:D8] | [D7:D4] | [D3:D0] |
| 8                      | 16 | Complex | 1                |           |          |         | I0      |
|                        |    |         | 2                |           |          |         | I0      |
|                        |    |         | 3                |           |          |         | Q0      |
|                        |    |         | 4                |           |          |         | Q0      |
|                        |    |         | 5                |           |          |         | I1      |
|                        |    |         | 6                |           |          |         | I1      |
|                        |    |         | 7                |           |          |         | Q1      |
|                        |    |         | 8                |           |          |         | Q1      |
|                        |    |         | 9                |           |          |         | I2      |
|                        |    |         | 10               |           |          |         | I2      |
|                        |    |         | 11               |           |          |         | Q2      |
|                        |    |         | 12               |           |          |         | Q2      |
|                        |    |         | 13               |           |          |         | I3      |
|                        |    |         | 14               |           |          |         | I3      |
|                        |    |         | 15               |           |          |         | Q3      |
|                        |    |         | 16               |           |          |         | Q3      |
| Datapath Configuration |    |         | LVDS Pin Mapping |           |          |         |         |
| BW                     | DW | Format  | DCO              | [D15:D12] | [D11:D8] | [D7:D4] | [D3:D0] |
| 16                     | 8  | Real    | 1                |           | R1       |         | R0      |
|                        |    |         | 2                |           | R3       |         | R2      |
| Datapath Configuration |    |         | LVDS Pin Mapping |           |          |         |         |
| BW                     | DW | Format  | DCO              | [D15:D12] | [D11:D8] | [D7:D4] | [D3:D0] |
| 16                     | 8  | Complex | 1                |           | Q0       |         | I0      |
|                        |    |         | 2                |           | Q1       |         | I1      |
|                        |    |         | 3                |           | Q2       |         | I2      |
|                        |    |         | 4                |           | Q3       |         | I3      |
| Datapath Configuration |    |         | LVDS Pin Mapping |           |          |         |         |
| BW                     | DW | Format  | DCO              | [D15:D12] | [D11:D8] | [D7:D4] | [D3:D0] |
| 16                     | 16 | Complex | 1                |           |          |         | I0      |
|                        |    |         | 2                |           |          |         | Q0      |
|                        |    |         | 3                |           |          |         | I1      |
|                        |    |         | 4                |           |          |         | Q1      |
|                        |    |         | 5                |           |          |         | I2      |
|                        |    |         | 6                |           |          |         | Q2      |
|                        |    |         | 7                |           |          |         | I3      |
|                        |    |         | 8                |           |          |         | Q3      |
| Datapath Configuration |    |         | LVDS Pin Mapping |           |          |         |         |
| BW                     | DW | Format  | DCO              | [D15:D12] | [D11:D8] | [D7:D4] | [D3:D0] |
| 32                     | 8  | Real    | 1 rise           |           | R1       |         | R0      |
|                        |    |         | 1 fall           |           | R3       |         | R2      |
| Datapath Configuration |    |         | LVDS Pin Mapping |           |          |         |         |
| BW                     | DW | Format  | DCO              | [D15:D12] | [D11:D8] | [D7:D4] | [D3:D0] |
| 32                     | 8  | Complex | 1 rise           |           | Q0       |         | I0      |
|                        |    |         | 1 fall           |           | Q1       |         | I1      |
|                        |    |         | 2 rise           |           | Q2       |         | I2      |
|                        |    |         | 2 fall           |           | Q3       |         | I3      |

| Datapath Configuration |    |         | LVDS Pin Mapping |           |          |         |         |
|------------------------|----|---------|------------------|-----------|----------|---------|---------|
| BW                     | DW | Format  | DCO              | [D15:D12] | [D11:D8] | [D7:D4] | [D3:D0] |
| 32                     | 16 | Complex | 1 rise           |           |          | I0      |         |
|                        |    |         | 1 fall           |           |          | Q0      |         |
|                        |    |         | 2 rise           |           |          | I1      |         |
|                        |    |         | 2 fall           |           |          | Q1      |         |
|                        |    |         | 3 rise           |           |          | I2      |         |
|                        |    |         | 3 fall           |           |          | Q2      |         |
|                        |    |         | 4 rise           |           |          | I3      |         |
|                        |    |         | 4 fall           |           |          | Q3      |         |



**NOTES**

**AD9789**

**NOTES**