

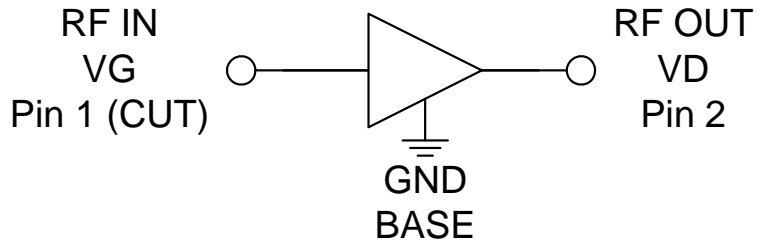

Features

- Wideband Operation: 1.2GHz to 1.4GHz
- Advanced GaN HEMT Technology
- Advanced Heat-Sink Technology
- Supports Multiple Pulse Conditions
 - 10% to 20% Duty Cycle
 - 100µs to 1ms Pulse Width
- Integrated Matching Components for High Terminal Impedances
- 50V Operation Typical Performance:
 - Output Pulsed Power: 280W
 - Pulse Width: 100µs, Duty Cycle 10%
 - Small Signal Gain: 15dB
 - High Efficiency (55%)
 - - 40 °C to 85 °C Operating Temperature



Functional Block Diagram

Product Description

The RFHA1020 is a 50V 280W high power discrete amplifier designed for L-band pulsed radar, air traffic control and surveillance and general purpose broadband amplifier applications. Using an advanced high power density Gallium Nitride (GaN) semiconductor process, these high performance amplifiers achieve high output power, high efficiency, and flat gain over a broad frequency range in a single package. The RFHA1020 is a matched power transistor packaged in a hermetic, flanged ceramic package. The package provides excellent thermal stability through the use of advanced heat sink and power dissipation technologies. Ease of integration is accomplished through the incorporation of single, optimized matching networks that provide wideband gain and power performance in a single amplifier.

Applications

- Radar
- Air Traffic Control and Surveillance
- General Purpose Broadband Amplifiers

Ordering Information

RFHA1020S2	2-Piece sample bag
RFHA1020SB	5-Piece bag
RFHA1020SQ	25-Piece bag
RFHA1020SR	50 Pieces on 7" short reel
RFHA1020TR13	250 Pieces on 13" reel
RFHA1020PCBA-410	Fully assembled evaluation board 1.2GHz to 1.4GHz; 50V operation

Optimum Technology Matching® Applied

- | | | | |
|--------------------------------------|--------------------------------------|-------------------------------------|----------------------------------------------|
| <input type="checkbox"/> GaAs HBT | <input type="checkbox"/> SiGe BiCMOS | <input type="checkbox"/> GaAs pHEMT | <input checked="" type="checkbox"/> GaN HEMT |
| <input type="checkbox"/> GaAs MESFET | <input type="checkbox"/> Si BiCMOS | <input type="checkbox"/> Si CMOS | <input type="checkbox"/> BiFET HBT |
| <input type="checkbox"/> InGaP HBT | <input type="checkbox"/> SiGe HBT | <input type="checkbox"/> Si BJT | |

RF MICRO DEVICES®, RFMD®, Optimum Technology Matching®, Enabling Wireless Connectivity™, PowerStar®, POLARIS™ TOTAL RADIO™ and UltimateBlue™ are trademarks of RFMD, LLC. BLUETOOTH is a trademark owned by Bluetooth SIG, Inc., U.S.A. and licensed for use by RFMD. All other trade names, trademarks and registered trademarks are the property of their respective owners. ©2012, RF Micro Devices, Inc.

Absolute Maximum Ratings

Parameter	Rating	Unit
Drain Voltage (V_D)	150	V
Gate Voltage (V_G)	-8 to +2	V
Gate Current (I_G)	155	mA
Operational Voltage	55	V
Ruggedness (VSWR)	10:1	
Storage Temperature Range	-55 to +125	°C
Operating Temperature Range (T_C)	-40 to +85	°C
Operating Junction Temperature (T_J)	250	°C
Human Body Model	Class 1A	
MTTF ($T_J < 200^\circ\text{C}$)	3.0E + 06	Hours
MTTF ($T_J < 250^\circ\text{C}$)	1.4E + 05	
Thermal Resistance, R_{th} (junction to case)		°C/W
$T_C = 85^\circ\text{C}$, DC bias only	0.90	
$T_C = 85^\circ\text{C}$, 100 μs pulse, 10% duty cycle	0.18	
$T_C = 85^\circ\text{C}$, 1ms pulse, 10% duty cycle	0.34	



Caution! ESD sensitive device.

Exceeding any one or a combination of the Absolute Maximum Rating conditions may cause permanent damage to the device. Extended application of Absolute Maximum Rating conditions to the device may reduce device reliability. Specified typical performance or functional operation of the device under Absolute Maximum Rating conditions is not implied.

The information in this publication is believed to be accurate and reliable. However, no responsibility is assumed by RF Micro Devices, Inc. ("RFMD") for its use, nor for any infringement of patents, or other rights of third parties, resulting from its use. No license is granted by implication or otherwise under any patent or patent rights of RFMD. RFMD reserves the right to change component circuitry, recommended application circuitry and specifications at any time without prior notice.



RFMD Green: RoHS compliant per EU Directive 2002/95/EC, halogen free per IEC 61249-2-21, < 1000ppm each of antimony trioxide in polymeric materials and red phosphorus as a flame retardant, and <2% antimony in solder.

* MTTF - median time to failure for wear-out failure mode (30% I_{DSS} degradation) which is determined by the technology process reliability.

Refer to product qualification report for FIT(random) failure rate.

Operation of this device beyond any one of these limits may cause permanent damage. For reliable continuous operation, the device voltage and current must not exceed the maximum operating values.

Bias Conditions should also satisfy the following expression: $P_{DISS} < (T_J - T_C)/R_{TH\ J-C}$ and $T_C = T_{CASE}$

Parameter	Specification			Unit	Condition
	Min.	Typ.	Max.		
Recommended Operating Conditions					
Drain Voltage (V_{DSQ})			50	V	
Gate Voltage (V_{GSQ})	-8	-3	-2	V	
Drain Bias Current		440		mA	
Frequency of Operation	1200		1400	MHz	
DC Functional Test					
$I_{G(OFF)}$ - Gate Leakage			2	mA	$V_G = -8V, V_D = 0V$
$I_{D(OFF)}$ - Drain Leakage			2.5	mA	$V_G = -8V, V_D = 50V$
$V_{GS(TH)}$ - Threshold Voltage		-3.5		V	$V_D = 50V, I_D = 40mA$
$V_{DS(ON)}$ - Drain Voltage at High Current		0.28		V	$V_G = 0V, I_D = 1.5A$
RF Functional Test					
Small Signal Gain		14		dB	$f = 1200MHz, P_{IN} = 30dBm$
Power Gain	12.3			dB	$f = 1200MHz, P_{IN} = 41.7dBm$
Input Return Loss		-8	- 5.5	dB	$f = 1200MHz, P_{IN} = 41.7dBm$
Output Power	54			dBm	$f = 1200MHz, P_{IN} = 41.7dBm$
Drain Efficiency	48	50		%	$f = 1200MHz, P_{IN} = 41.7dBm$

Parameter	Specification			Unit	Condition
	Min.	Typ.	Max.		
RF Functional Test (continued)					[1], [2]
Small Signal Gain		15		dB	f = 1300MHz, P _{IN} = 30dBm
Power Gain	12.3			dB	f = 1300MHz, P _{IN} = 41.7dBm
Input Return Loss		-10	-6	dB	f = 1300MHz, P _{IN} = 41.7dBm
Output Power	54			dBm	f = 1300MHz, P _{IN} = 41.7dBm
Drain Efficiency	48	55		%	f = 1300MHz, P _{IN} = 41.7dBm
Small Signal Gain		14		dB	f = 1400MHz, P _{IN} = 30dBm
Power Gain	12.3			dB	f = 1400MHz, P _{IN} = 41.7dBm
Input Return Loss		-8	-5.5	dB	f = 1400MHz, P _{IN} = 41.7dBm
Output Power	54			dBm	f = 1400MHz, P _{IN} = 41.7dBm
Drain Efficiency	48	55		%	f = 1400MHz, P _{IN} = 41.7dBm
RF Typical Performance					[1], [2]
Frequency Range	1200		1400	MHz	
Small Signal Gain		15		dB	P _{IN} = 30dBm
Power Gain		13		dB	P _{OUT} = 54.50dBm
Gain Variation with Temperature			-0.015	dB/°C	At peak output power
Output Power (P _{SAT})		54.50		dBm	Peak output power
		280		W	Peak output power
Drain Efficiency		55		%	At peak output power

[1] Test Conditions: PW = 100μs, DC = 10%, V_{DSQ} = 50V, I_{DQ} = 440mA, T = 25 °C.

[2] Performance in a standard tuned test fixture.

Typical Performance in Standard Fixed Tune Test Fixture (T = 25 °C, unless otherwise noted)

Gain versus Output Power (f = 1300MHz)
(Pulsed 10% duty cycle, 1ms, $V_D = 50V$, $I_{DQ} = 440mA$)

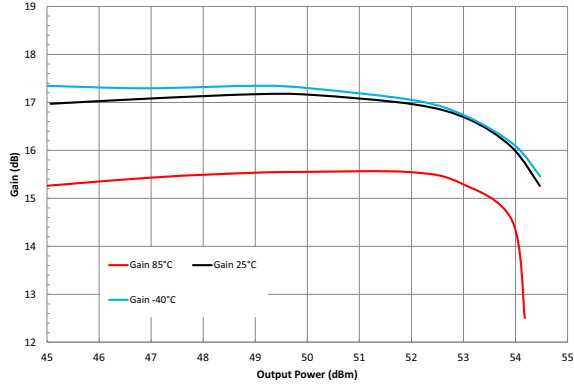

Efficiency versus Output Power (f = 1300MHz)
(Pulsed 10% duty cycle, 1ms, $V_D = 50V$, $I_{DQ} = 440mA$)

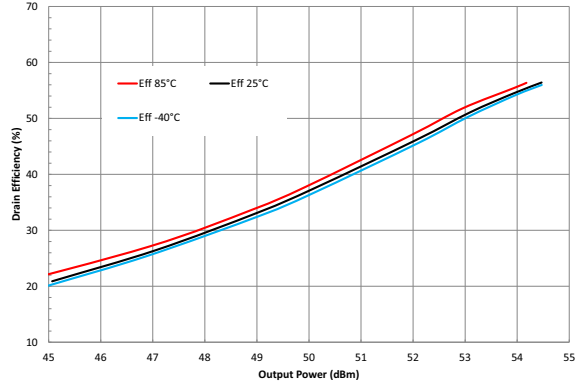

Input Return Loss versus Output Power (f = 1300MHz)
(Pulsed 10% duty cycle, 1ms, $V_D = 50V$, $I_{DQ} = 440mA$)

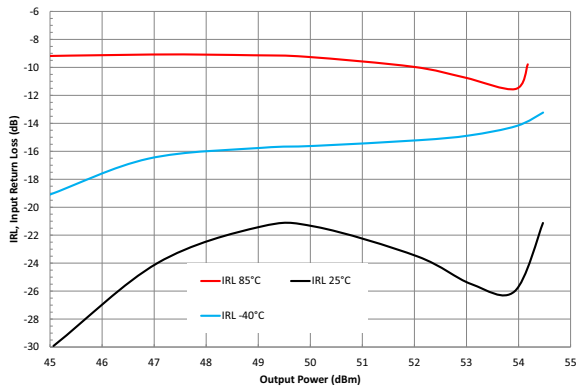

Small Signal Performance versus Frequency, $P_{OUT} = 44dBm$
(Pulsed 10% duty cycle, 100µs, $V_D = 50V$, $I_{DQ} = 440mA$)

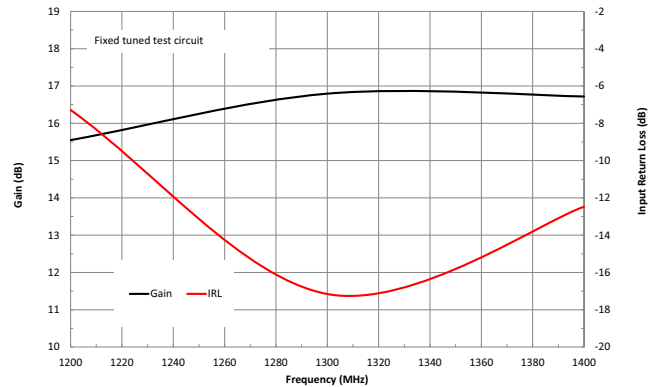

Gain/IRL versus Frequency, $P_{OUT} = 54dBm$
(Pulsed 10% duty cycle, 100µs, $V_D = 50V$, $I_{DQ} = 440mA$)

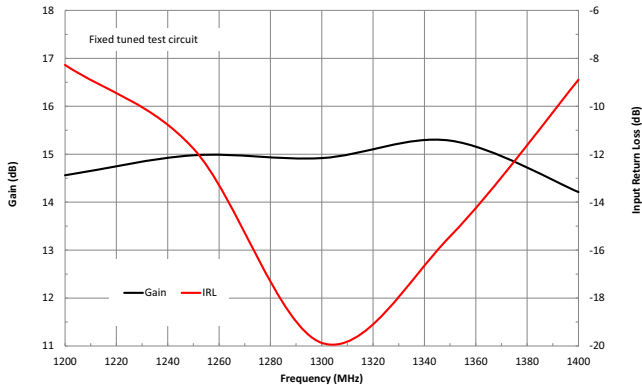

Drain Efficiency versus Frequency, $P_{OUT} = 54dBm$
(Pulsed 10% duty cycle, 100µs, $V_D = 50V$, $I_{DQ} = 440mA$)

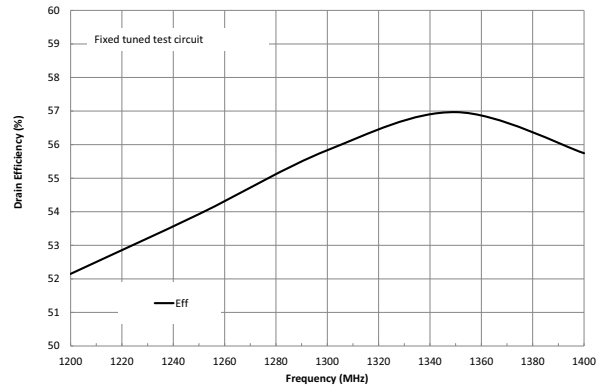

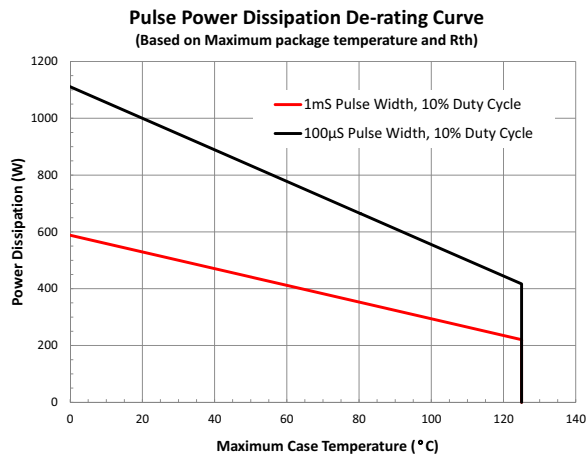
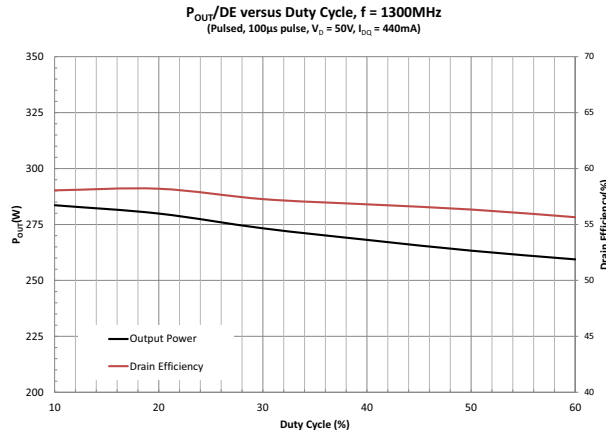
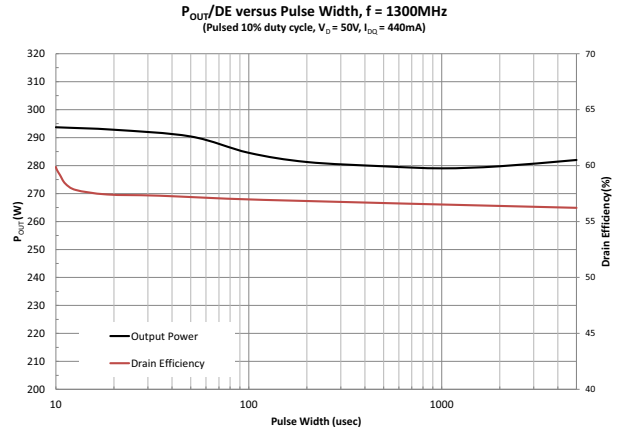
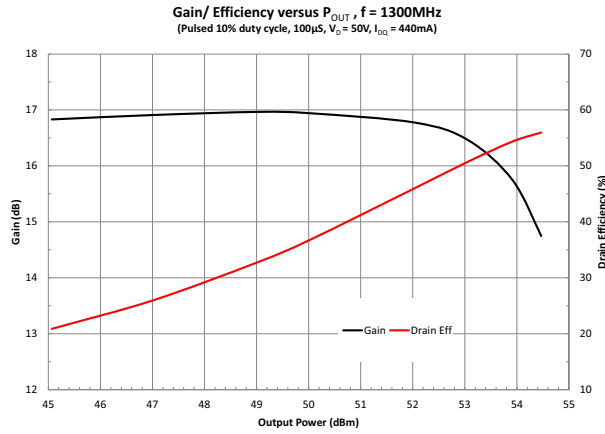

Package Drawing

(All dimensions in mm)

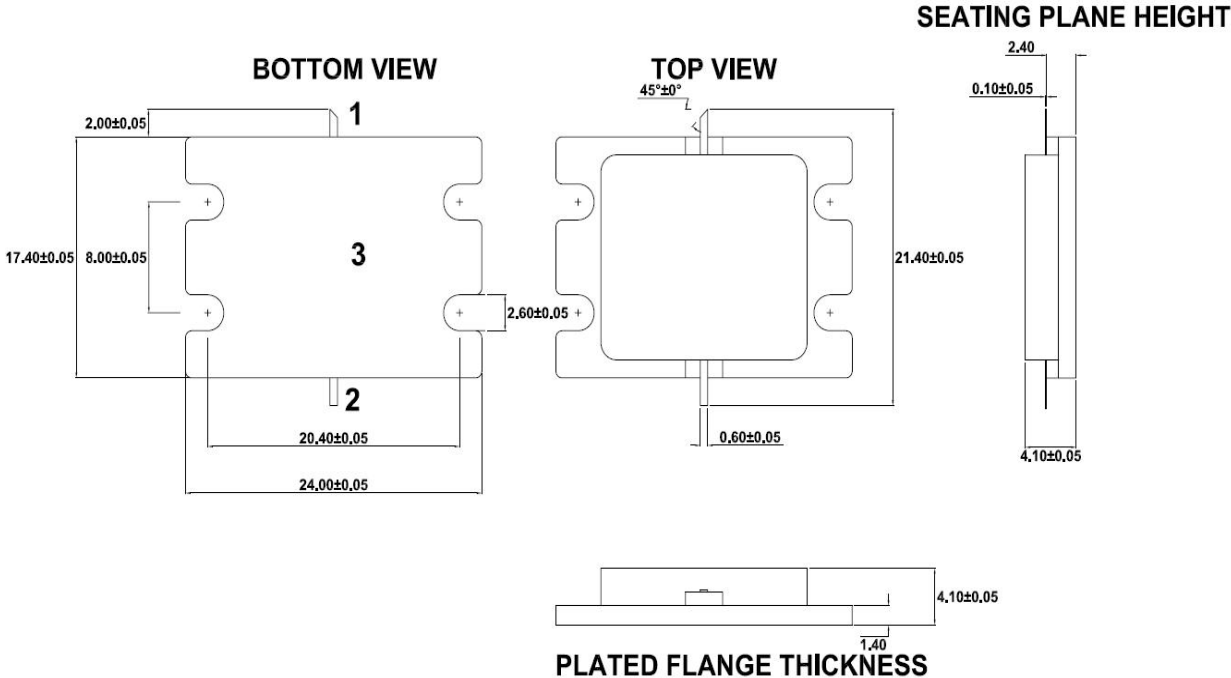

Pin Names and Descriptions

Pin	Name	Description
1	VG	Gate - VG RF Input
2	VD	Drain - VD RF Output
3	GND	Source - Ground Base

Bias Instruction for RFHA1020 Evaluation Board

ESD Sensitive Material. Please use proper ESD precautions when handling devices of evaluation board.
 Evaluation board requires additional external fan cooling.
 Connect all supplies before powering up the evaluation board.

1. Connect RF cables at RFin and RFOUT.
2. Connect ground to the ground supply terminal, and ensure that both the VG and VD grounds are also connected to this ground terminal.
3. Apply -8V to VG.
4. Apply 50V to VD.
5. Increase V_G until drain current reaches 440mA or desired bias point.
6. Turn on the RF input.

IMPORTANT NOTE: Depletion mode device; when biasing the device, V_G must be applied before V_D . When removing bias, V_D must be removed before V_G is removed. Failure to follow this sequence will cause the device to fail.

NOTE: For optimal RF performance, consistent and optimal heat removal from the base of the package is required. A thin layer of thermal grease should be applied to the interface between the base of the package and the equipment chassis. It is recommended that a small amount of thermal grease is applied to the underside of the device package. Even application and removal of excess thermal grease can be achieved by spreading the thermal grease using a razor blade. The package should then be bolted to the chassis and input and output leads soldered to the circuit board.

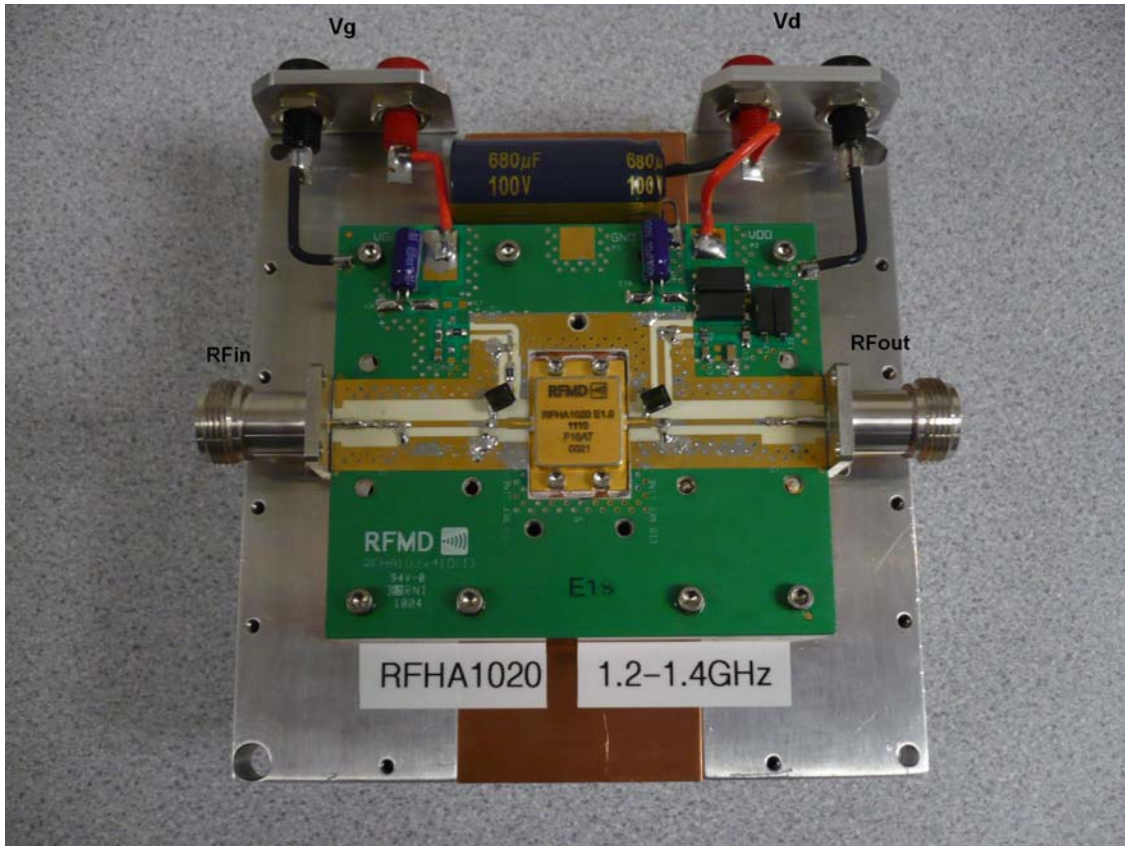

Evaluation Board Schematic

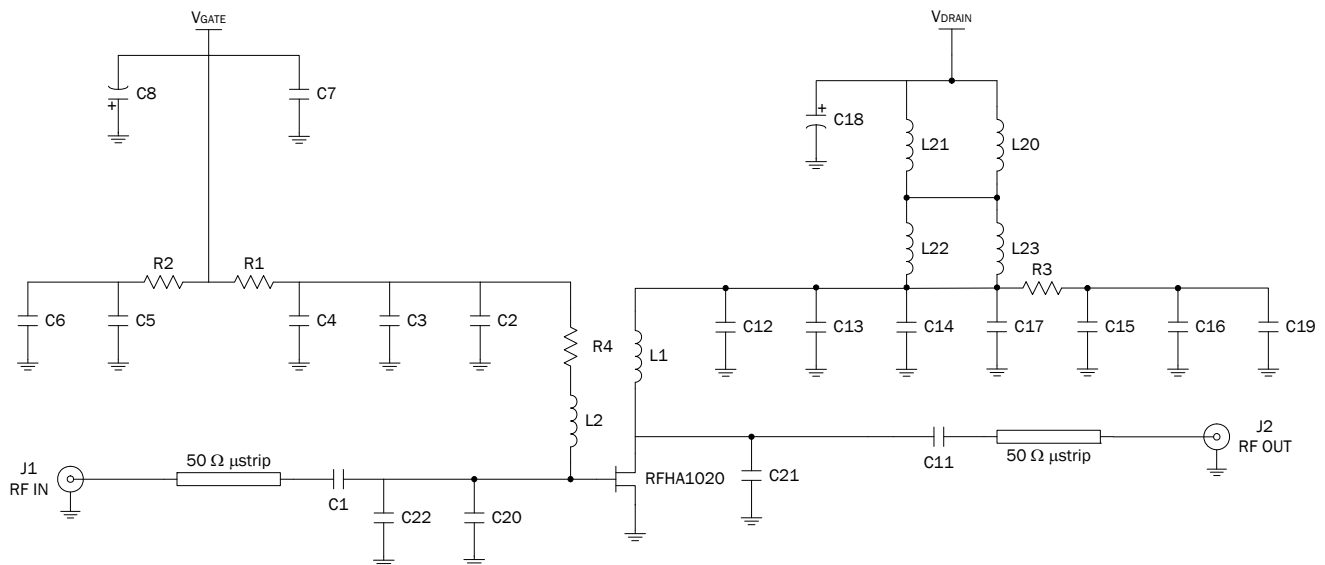

Evaluation Board Bill of Materials

Component	Value	Manufacturer	Part Number
R1, R4	10Ω	Panasonic	ERJ-8GEYJ100V
R2	0Ω	Panasonic	ERJ-8GEY0R00
R3	51Ω	Panasonic	ERJ-8GEYJ510
C1, C2, C11, C13	82pF	Dialectric Labs	800A820JT
C17	56pF	ATC	ATC800A560JT
C5	0.1μF	Panasonic	ECJ-2VB1H104K
C6, C15	10000pF	Panasonic	ECJ-2VB1H103K
C16	0.1μF	Panasonic	ECJ-2VB1H104K
C8, C18	10μF	Panasonic	ECA-2AM100
C20	3.9pF	ATC	800A3R9CT
C21	1.1pF	ATC	800A1R1BT
C22	0.3pF	ATC	800A0R3BT
L20, L21	115Ω, 10A	Steward	28F0181-1SR-10
L22, L23	75Ω, 10A	Steward	35F0121-1SR-10
C3, C4, C7, C12, C14, C19	NOT POPULATED		

Evaluation Board Layout

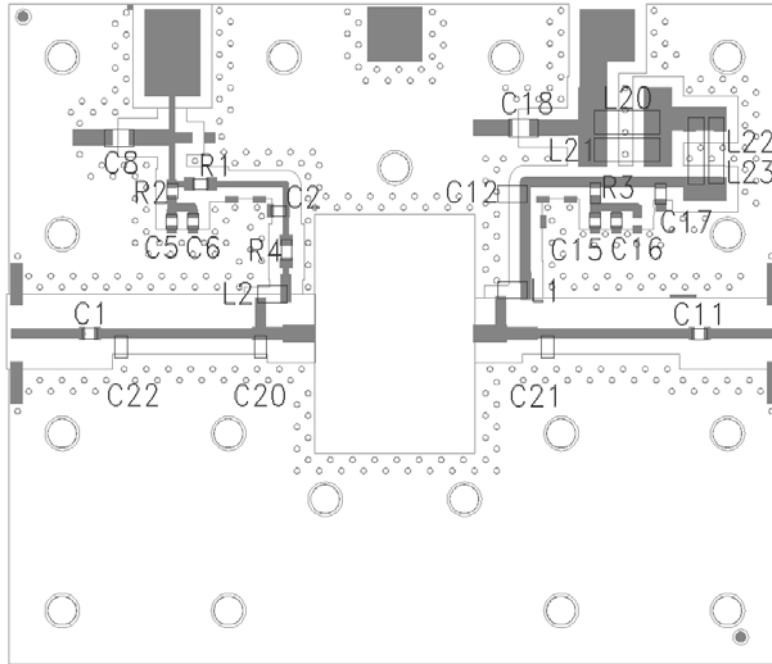

Device Impedances

Frequency	Z Source (Ω)	Z Load (Ω)
1200MHz	10.7 - j5.0	33.9 - j10
1300MHz	9.48 - j3.24	34.2 - j10.9
1400MHz	8.2 - j1.2	34.5 - j12.33

Note: Device impedances reported are the measured evaluation board impedances chosen for a tradeoff of efficiency, peak power, and linear performance across the entire frequency bandwidth.

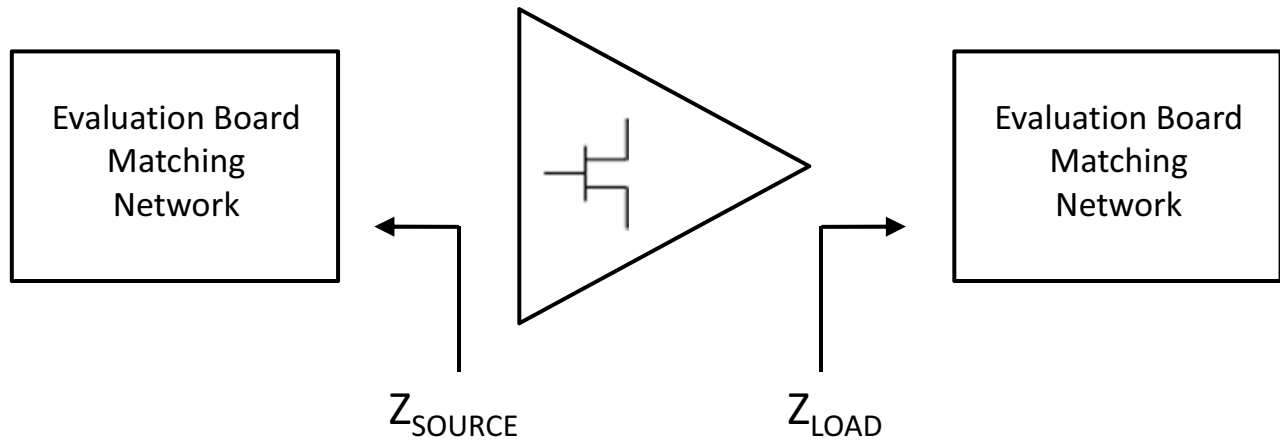

Device Handling/Environmental Conditions

GaN HEMT devices are ESD sensitive materials. Please use proper ESD precautions when handling devices or evaluation boards.

GaN HEMT Capacitances

The physical structure of the GaN HEMT results in three terminal capacitors similar to other FET technologies. These capacitances exist across all three terminals of the device. The physical manufactured characteristics of the device determine the value of the C_{DS} (drain to source), C_{GS} (gate to source) and C_{GD} (gate to drain). These capacitances change value as the terminal voltages are varied. RFMD presents the three terminal capacitances measured with the gate pinched off ($V_{GS} = -8V$) and zero volts applied to the drain. During the measurement process, the parasitic capacitances of the package that holds the amplifier is removed through a calibration step. Any internal matching is included in the terminal capacitance measurements. The capacitance values presented in the typical characteristics table of the device represent the measured input (C_{ISS}), output (C_{OSS}), and reverse (C_{RSS}) capacitance at the stated bias voltages. The relationship to three terminal capacitances is as follows:

$$C_{ISS} = C_{GD} + C_{GS}$$

$$C_{OSS} = C_{GD} + C_{DS}$$

$$C_{RSS} = C_{GD}$$

DC Bias

The GaN HEMT device is a depletion mode high electron mobility transistor (HEMT). At zero volts V_{GS} the drain of the device is saturated and uncontrolled drain current will destroy the transistor. The gate voltage must be taken to a potential lower than the source voltage to pinch off the device prior to applying the drain voltage, taking care not to exceed the gate voltage maximum limits. RFMD recommends applying $V_{GS} = -5V$ before applying any V_{DS} .

RF Power transistor performance capabilities are determined by the applied quiescent drain current. This drain current can be adjusted to trade off power, linearity, and efficiency characteristics of the device. The recommended quiescent drain current (I_{DQ}) shown in the RF typical performance table is chosen to best represent the operational characteristics for this device, considering manufacturing variations and expected performance. The user may choose alternate conditions for biasing this device based on performance tradeoffs.

Mounting and Thermal Considerations

The thermal resistance provided as R_{TH} (junction to case) represents only the packaged device thermal characteristics. This is measured using IR microscopy capturing the device under test temperature at the hottest spot of the die. At the same time, the package temperature is measured using a thermocouple touching the backside of the die embedded in the device heatsink but sized to prevent the measurement system from impacting the results. Knowing the dissipated power at the time of the measurement, the thermal resistance is calculated.

In order to achieve the advertised MTF, proper heat removal must be considered to maintain the junction at or below the maximum of 200 °C. Proper thermal design includes consideration of ambient temperature and the thermal resistance from ambient to the back of the package including heatsinking systems and air flow mechanisms. Incorporating the dissipated DC power, it is possible to calculate the junction temperature of the device.