

FEATURES

Divide-by-4 prescaler

High frequency operation: 4 GHz to 18 GHz

Integrated RF decoupling capacitors

Low power consumption

Active mode: 30 mA

Power-down mode: 7 mA

Low phase noise: -150 dBc/Hz

Single dc supply: 3.3 V compatible with ADF4xxx PLLs

Temperature range: -40°C to $+105^{\circ}\text{C}$

Small package: 3 mm \times 3 mm LFCSP

APPLICATIONS

PLL frequency range extender

Point-to-point radios

VSAT radios

Communications test equipment

GENERAL DESCRIPTION

The ADF5001 prescaler is a low noise, low power, fixed RF divider block that can be used to divide down frequencies as high as 18 GHz to a lower frequency suitable for input into a PLL IC, such as the [ADF4156](#) or [ADF4106](#). The ADF5001 provides a divide-by-4 function. The ADF5001 operates off a 3.3 V supply and has differential $100\ \Omega$ RF outputs to allow direct interface to the differential RF inputs of PLLs such as the [ADF4156](#) and [ADF4106](#).

FUNCTIONAL BLOCK DIAGRAM

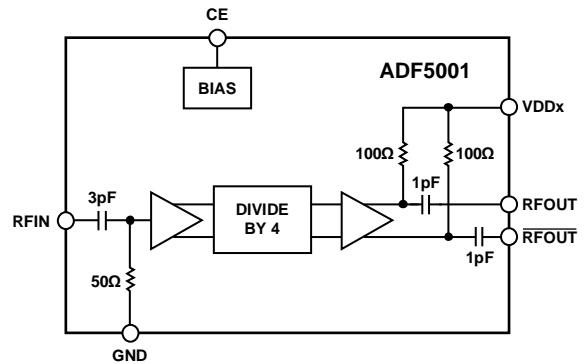

Figure 1.

08/402-001

Rev. A

Information furnished by Analog Devices is believed to be accurate and reliable. However, no responsibility is assumed by Analog Devices for its use, nor for any infringements of patents or other rights of third parties that may result from its use. Specifications subject to change without notice. No license is granted by implication or otherwise under any patent or patent rights of Analog Devices. Trademarks and registered trademarks are the property of their respective owners.

ADF5001* PRODUCT PAGE QUICK LINKS

Last Content Update: 02/23/2017

COMPARABLE PARTS

View a parametric search of comparable parts.

EVALUATION KITS

- ADF5001 Evaluation Board

DOCUMENTATION

Data Sheet

- ADF5001: 4 GHz to 18 GHz Divide-by-4 Prescaler Data Sheet

TOOLS AND SIMULATIONS

- ADIsimPLL™
- ADIsimRF

REFERENCE DESIGNS

- CN0174

REFERENCE MATERIALS

Product Selection Guide

- RF Source Booklet

Technical Articles

- RF Meets Power Lines: Designing Intelligent Smart Grid Systems that Promote Energy Efficiency

DESIGN RESOURCES

- ADF5001 Material Declaration
- PCN-PDN Information
- Quality And Reliability
- Symbols and Footprints

DISCUSSIONS

View all ADF5001 EngineerZone Discussions.

SAMPLE AND BUY

Visit the product page to see pricing options.

TECHNICAL SUPPORT

Submit a technical question or find your regional support number.

DOCUMENT FEEDBACK

Submit feedback for this data sheet.

TABLE OF CONTENTS

Features	1	Pin Configuration and Function Descriptions.....	5
Applications.....	1	Typical Performance Characteristics	6
General Description	1	Evaluation Board PCB	7
Functional Block Diagram	1	PCB Material Stack-Up	7
Revision History	2	Bill of Materials.....	7
Specifications.....	3	Application Circuit.....	8
Absolute Maximum Ratings.....	4	Outline Dimensions	9
ESD Caution.....	4	Ordering Guide	9

REVISION HISTORY

6/10—Rev. 0 to Rev. A

Change to Features Section	1
Change to Applications Section.....	1
Changes to Figure 1	1
Changes to Specifications Section	3
Changes to Thermal Impedance Ratings, Table 2.....	4
Changes to Figure 4 Through Figure 7	6
Changes to Evaluation Board PCB Section.....	7
Changes to Figure 8.....	7
Change to Table 4	7
Changes to Figure 10.....	8
Changes to Ordering Guide	9

10/09—Revision 0: Initial Version

SPECIFICATIONS

VDD1 = VDD2 = 3.3 V \pm 10%, GND = 0 V; dBm referred to 50 Ω ; T_A = T_{MIN} to T_{MAX}, unless otherwise noted. The operating temperature range is -40°C to $+105^{\circ}\text{C}$.

Table 1.

Parameter	Min	Typ	Max	Unit	Test Conditions/Comments
RF CHARACTERISTICS					
Input Frequency	4		18	GHz	
RF Input Sensitivity	-10		+10	dBm	4 GHz to 18 GHz
Output Power	-10	-5		dBm	Single-ended output connected into 50 Ω load
	-7	-2		dBm	Differential outputs connected into 100 Ω differential load
Output Voltage Swing	200	330		mV p-p	Peak-to-peak voltage swing on each single-ended output, connected into 50 Ω load
	400	660		mV p-p	Peak-to-peak voltage swing on differential output, connected into 100 Ω differential load
		1000		mV p-p	Peak-to-peak voltage swing on each single-ended output, no load condition
Phase Noise		-150		dBc/Hz	Input frequency (f _{IN}) = 12 GHz, offset = 100 kHz
Reverse Leakage		-60		dBm	RF input power (P _{IN}) = 0 dBm, RF _{OUT} = 4 GHz
Second Harmonic Content		-38		dBc	
Third Harmonic Content		-12		dBc	
Fourth Harmonic Content		-20		dBc	
Fifth Harmonic Content		-19		dBc	
CE INPUT					
V _{IH} , Input High Voltage	2.2			V	
V _{IL} , Input Low Voltage			0.3	V	
POWER SUPPLIES					
Voltage Supply	3.0	3.3	3.6	V	
IDD (IDD1 + IDD2)					
Active		30	60	mA	CE is high
Power-Down		7	25	mA	CE is low

ABSOLUTE MAXIMUM RATINGS

Table 2.

Parameter	Rating
VDDx to GND	-0.3 V to +3.9 V
RFIN	10 dBm
Operating Temperature Range	
Industrial (B Version)	-40°C to +105°C
Storage Temperature Range	-65°C to +150°C
Maximum Junction Temperature	150°C
LFCSP Thermal Impedance	
θ_{JA} (Ambient)	90°C/W
θ_{JC} (Case)	30°C/W
Peak Temperature	260°C
Time at Peak Temperature	40 sec

Stresses above those listed under Absolute Maximum Ratings may cause permanent damage to the device. This is a stress rating only; functional operation of the device at these or any other conditions above those indicated in the operational section of this specification is not implied. Exposure to absolute maximum rating conditions for extended periods may affect device reliability.

This device is a high performance RF integrated circuit with an ESD rating of 2 kV, human body model (HBM) and is ESD sensitive. Proper precautions should be taken for handling and assembly.

ESD CAUTION



ESD (electrostatic discharge) sensitive device. Charged devices and circuit boards can discharge without detection. Although this product features patented or proprietary protection circuitry, damage may occur on devices subjected to high energy ESD. Therefore, proper ESD precautions should be taken to avoid performance degradation or loss of functionality.

PIN CONFIGURATION AND FUNCTION DESCRIPTIONS

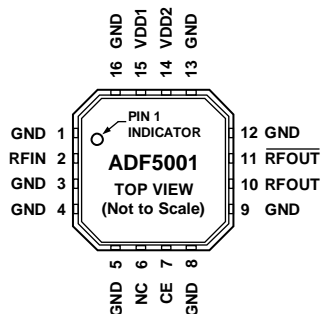

- NOTES**
1. NC = NO CONNECT.
 2. THE EXPOSED PADDLE MUST BE CONNECTED TO GND.

098402-002

Figure 2. Pin Configuration

Table 3. Pin Function Descriptions

Pin No.	Mnemonic	Description
1, 3, 4, 5, 8, 9, 12, 13, 16	GND	RF Ground. All ground pins should be tied together.
2	RFIN	Single-Ended 50 Ω Input to the RF Prescaler. This pin is ac-coupled internally via a 3 pF capacitor.
6	NC	No Connect. This pin can be left unconnected.
7	CE	Chip Enable. This pin is active high. When CE is brought low, the part enters into power-down mode. If this functionality is not required, the pin can remain unconnected because it is pulled up internally through a weak pull-up resistor.
10	RFOUT	Divided Down Output of the Prescaler. This pin has an internal 100 Ω load resistor tied to VDD2 and an ac-coupling capacitor of 1 pF.
11	$\overline{\text{RFOUT}}$	Complementary Divided Down Output of the Prescaler. This pin has an internal 100 Ω load resistor tied to VDD2 and an ac-coupling capacitor of 1 pF.
14	VDD2	Voltage Supply for the Output Stage. Decouple this pin to ground with a 1 nF capacitor and tie it directly to VDD1.
15	VDD1	Voltage Supply for the Input Stage and Divider Block. Decouple this pin to ground with a 1 nF capacitor.
N/A ¹	EP	The LFCSP package has an exposed paddle that must be connected to GND.

¹ N/A means not applicable.

TYPICAL PERFORMANCE CHARACTERISTICS

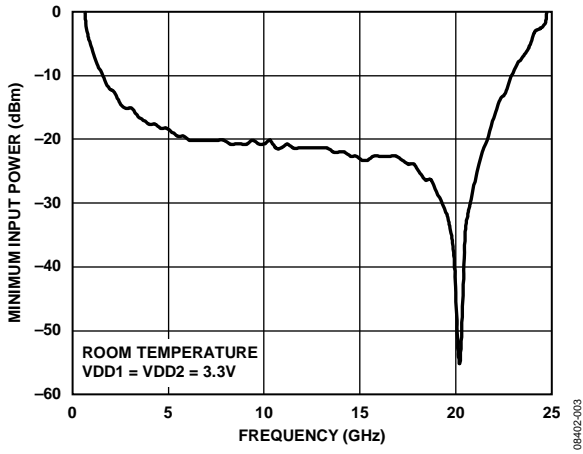

Figure 3. RFIN Sensitivity

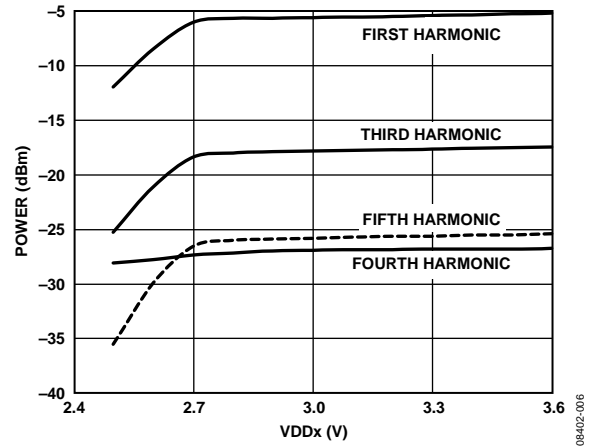

Figure 6. RFOUT Harmonic Content

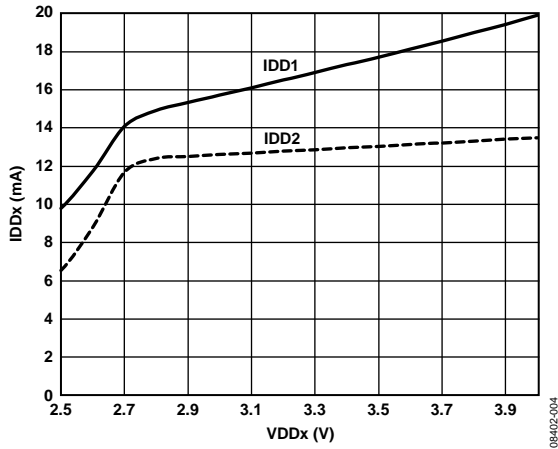

Figure 4. IDD1 and IDD2 vs. VDDx

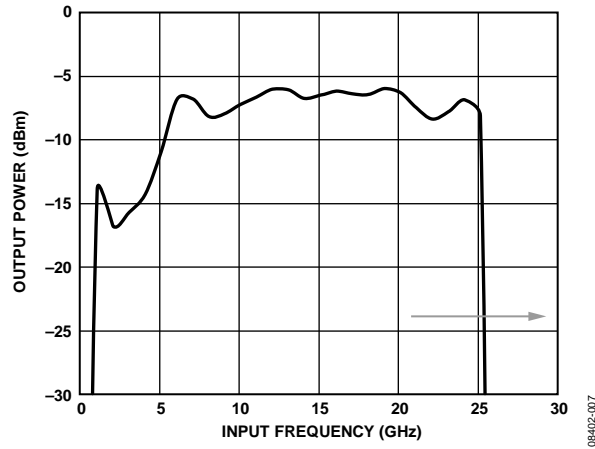

Figure 7. RFOUT Power vs. RFIN Frequency, $f_{IN} = 10$ GHz, $V_{DD} = 3.3$ V

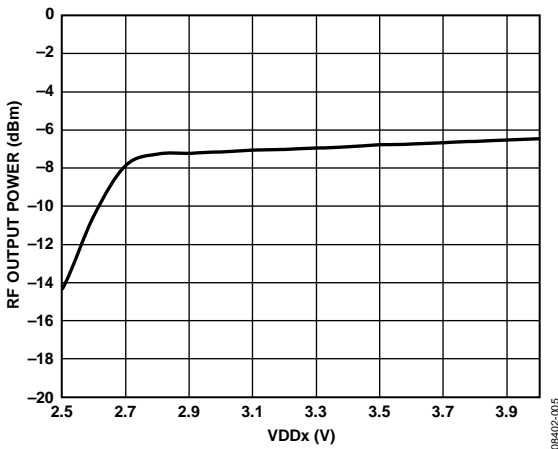

Figure 5. RFOUT Power (Single-Ended) vs. VDDx, $f_{IN} = 10$ GHz, $P_{IN} = 0$ dBm

EVALUATION BOARD PCB

The evaluation board has four connectors as shown in Figure 8. The RF input connector (J4) is a high frequency precision SMA connector from Emerson. This connector is mechanically compatible with SMA/3.5 mm and 2.92 mm cables.

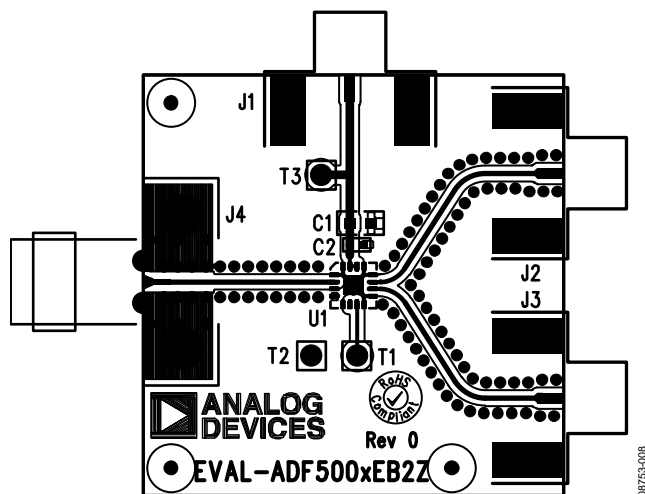

Figure 8. Evaluation Board Silkscreen—Top View

The evaluation board is powered from a single 3.0 V to 3.6 V supply, which should be connected to the J1 SMA connector. The power supply can also be connected using the T3 (VDDx) and T2 (GND) test points.

The differential RF outputs are brought out on the J2 and J3 SMA connectors. If only one of the outputs is being used, the unused output should be correctly terminated using a 50 Ω SMA termination.

The chip enable (CE) pin can be controlled using the T1 test point. If this function is not required, the test point can remain unconnected.

PCB MATERIAL STACK-UP

The evaluation board is built using Rogers RO4003C material (0.008 in.). RF track widths are 0.015 in. to achieve a controlled 50 Ω characteristic impedance. The complete PCB stack-up is shown in Figure 9.

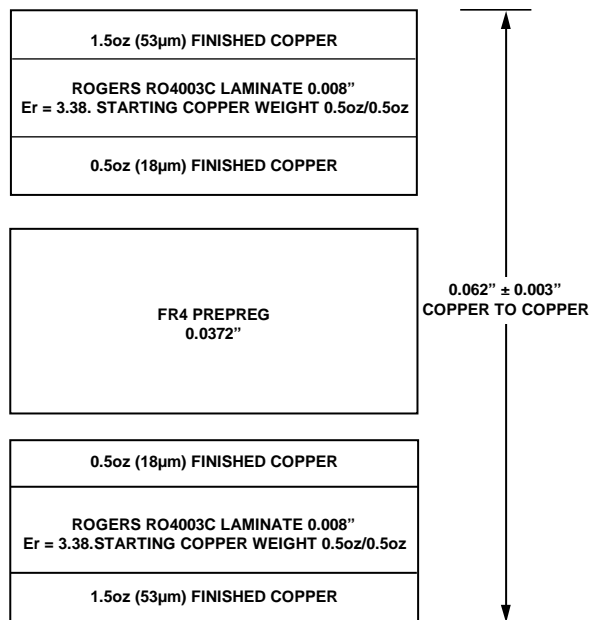

Figure 9. Evaluation Board PCB Layer Stack-Up

BILL OF MATERIALS

Table 4.

Qty.	Reference Designator	Description	Supplier/Part Number
1	C1	0.1 µF, 0603 capacitor	Murata GRM188R71H104KA93D
1	C2	10 pF, 0402 capacitor	Murata GRM1555C1H100JZ01D
1	J4	3.5 mm RF SMA connector	Emerson 142-0761-801
3	J1, J2, J3	3.5 mm RF SMA connector	Johnson Components 142-0701-851
3	T1, T2, T3	Test points	Vero 20-2137
1	U1	ADF5001 RF prescaler	Analog Devices, Inc., ADF5001BCPZ

OUTLINE DIMENSIONS

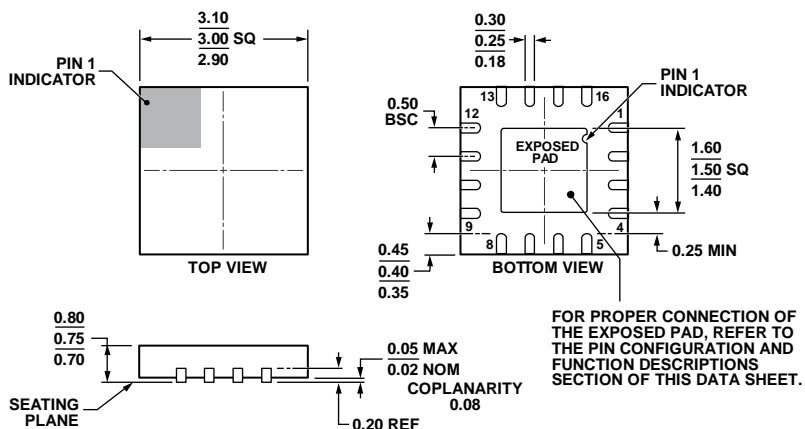

COMPLIANT TO JEDEC STANDARDS MO-220-WEED-6.

Figure 11. 16-Lead Lead Frame Chip Scale Package [LFCSP_WQ]
 3 mm × 3 mm Body, Very Very Thin Quad
 (CP-16-18)
 Dimensions shown in millimeters

111808-A

ORDERING GUIDE

Model ¹	Temperature Range	Package Description	Package Option	Branding
ADF5001BCPZ	-40°C to +105°C	16-Lead Lead Frame Chip Scale Package (LFCSP_WQ)	CP-16-18	Q1S
ADF5001BCPZ-RL7	-40°C to +105°C	16-Lead Lead Frame Chip Scale Package (LFCSP_WQ), 7" Tape and Reel	CP-16-18	Q1S
EVAL-ADF5001EB2Z		Evaluation Board		

¹ Z = RoHS Compliant Part.

ADF5001

NOTES

NOTES

ADF5001

NOTES