

【4. 性能 PERFORMANCE】

4-1. 電気的性能 Electrical Performance

項目 Item	条件 Test Condition	規格 Requirement
4-1-1 接触抵抗 Contact Resistance	適合FPCを嵌合させ、開放電圧 20mV 以下、短絡電流 10mA 以下にて測定する。 (JIS C5402-2-1) Mate applicable FPC, measured at the open circuit voltage 20mV MAXIMUM and short circuit 10mA MAXIMUM. (JIS C5402-2-1)	40milliohm MAXIMUM
4-1-2 絶縁抵抗 Insulation Resistance	適合FPCを嵌合させ、隣接するターミナル間及びターミナル、アース間に、DC 125Vを印加し測定する。 (JIS C5402-3-1/MIL-STD-202 試験法 302) Mate applicable FPC, measured by applying DC 125V between adjacent terminal or terminal and ground. (JIS C5402-3-1/MIL-STD-202 Method 302)	50 Megaohm MINIMUM
4-1-3 耐電圧 Dielectric Strength	適合FPCを嵌合させ、隣接するターミナル間及びターミナル、アース間に、AC125V(実効値)を1分間印加する。 (JIS C5402-4-1/MIL-STD-202 試験法 301) Mate applicable FPC, applying AC 125V(effective value) between adjacent terminal or terminal and ground for 1 minutes. (JIS C5402-4-1/MIL-STD-202 Method 301)	異状なきこと No Breakdown

4-2. 機械的性能 Mechanical Performance

項目 Item	条件 Test Condition	規格 Requirement
4-2-1 FPC保持力 FPC Retention Force	適合FPCを挿入し、アクチュエータを閉じた状態にてFPCを毎分25±3 mmの速さで嵌合軸方向に対して真っ直ぐ引き抜く。 Mate applicable FPC, close actuator, and pull the FPC at the speed rate of 25 +/-3 mm per minute.	第7項参照 Refer to paragraph 7

REVISE ON PC ONLY		TITLE: 0.5 FPC CONN. ZIF E/O (Hgt=1.9mm) 2 CONTACTS TYPE
A	SEE SHEET 1 OF 19	
REV.	DESCRIPTION	THIS DOCUMENT CONTAINS INFORMATION THAT IS PROPRIETARY TO MOLEX ELECTRONIC TECHNOLOGIES, LLC AND SHOULD NOT BE USED WITHOUT WRITTEN PERMISSION

DOCUMENT NUMBER 5051100004	DOC. TYPE PS	DOC. PART 000	CUSTOMER GENERAL	SHEET 2 OF 19
-------------------------------	-----------------	------------------	---------------------	------------------

4-3. その他 Environmental Performance and Others

項目 Item		条件 Test Condition	規格 Requirement	
4-3-1	アクチュエータ 繰り返し動作 Durability of Actuator Operation	無通電状態にて1分間に10回以下の速さで、 FPCの挿入、アクチュエータの開閉、FPCの抜 去の動作を10回繰り返す。 Insert FPC, close and open actuator, withdraw FPC to 10 cycles, at the speed rate of less than 10 cycles per minute in the power-off state.	接触抵抗 Contact Resistance	60 milliohm MAXIMUM
4-3-2	温度上昇 Temperature Rise	適合するFPCを嵌合させ、最大許容電流を通 電し、コネクタの温度上昇分を測定する。 (UL 498) Mate applicable FPC, measure the temperature rise of contact when the maximum AC rated current is passed. (UL 498)	温度上昇 Temperature Rise	30 °C MAXIMUM
4-3-3	耐振動性 Vibration	適合FPCを嵌合させ、DC 1mA 通電状態にて、 嵌合軸を含む互いに垂直な3方向に掃引割合10 ~55~10Hz/分、全振幅 1.5mmの振動を各2 時間加える。 (JIS C 60068-2-6/MIL-STD-202 試験法 201) Mate applicable FPC, add to each 2 hours with ratio sweep 10-55-10 Hz per minute and total amplitude 1.5 mm vibration at 3 directions mutually vertical including fitting axis in DC1 mA electricity state. (JIS C 60068-2-6/MIL-STD-202 Method 201)	外観 Appearance	異常なきこと No Damage
			接触抵抗 Contact Resistance	60 milliohm MAXIMUM
			瞬断 Discontinuity	1.0 microsecond MAXIMUM
4-3-4	耐衝撃性 Mechanical Shock	適合FPCを嵌合させ、DC 1mA 通電状態にて、 嵌合軸を含む互いに垂直な6方向に、490m/s ² {50G}の衝撃を作用時間11ミリ秒で各3回加え る。 (JIS C 60068-2-27/MIL-STD-202 試験法 213) Mate applicable FPC, add to each 3 times with impact of 490m/s ² {50G} on action time 11milliseconds at 6 directions mutually vertical including fitting axis in DC1 mA electricity state. (JIS C 60068-2-27/MIL-STD-202 Method 213)	外観 Appearance	異常なきこと No Damage
			接触抵抗 Contact Resistance	60 milliohm MAXIMUM
			瞬断 Discontinuity	1 microsecond MAXIMUM

REVISE ON PC ONLY

A

SEE SHEET 1 OF 19

TITLE:

0.5 FPC CONN. ZIF E/O (Hgt=1.9mm)
2 CONTACTS TYPE

THIS DOCUMENT CONTAINS INFORMATION THAT IS PROPRIETARY TO MOLEX ELECTRONIC
TECHNOLOGIES, LLC AND SHOULD NOT BE USED WITHOUT WRITTEN PERMISSION

REV.

DESCRIPTION

DOCUMENT NUMBER
5051100004

DOC. TYPE
PS

DOC. PART
000

CUSTOMER
GENERAL

SHEET
3 OF 19

項目 Item		条件 Test Condition	規格 Requirement	
4-3-5	耐熱性 Heat Resistance	適合するFPCを嵌合させ、125±2°Cの雰囲気中に96時間放置する。試験後、1～2時間室温に放置する。 (JIS C60068-2-2/MIL-STD-202 試験法 108) Mate applicable FPC, exposing for 96 hours in the atmosphere of 125+/-2 degree C. After the test, allowed to stand at room temperature for 1 to 2 hours. (JIS C60068-2-2/MIL-STD-202 Method 108)	外観 Appearance	異常なきこと No Damage
			接触抵抗 Contact Resistance	60 milliohm MAXIMUM
4-3-6	耐寒性 Cold Resistance	適合するFPCを嵌合させ、-40±3°Cの雰囲気中に96時間放置する。試験後、1～2時間室温に放置する。 (JIS C60068-2-1) Mate applicable FPC and expose to -40+/-3 degree C for 96 hours. Upon completion of the exposure period, the test specimens shall be conditioned at ambient room conditions for 1 to 2 hours. (JIS C60068-2-1)	外観 Appearance	異常なきこと No Damage
			接触抵抗 Contact Resistance	60 milliohm MAXIMUM
4-3-7	耐湿性 Humidity	適合FPCを嵌合させ、60±2°C 相対湿度 90～95% の雰囲気中に 96時間放置する。試験後、1～2時間室温に放置する。 (JIS C60068-2-78/MIL-STD-202 試験方法 103) Mate applicable FPC, exposing for 96 hours in an atmosphere of 60+/-2 degree C, relative humidity 90 to 95%. After the test, allowed to stand at room temperature for 1 to 2 hours. (JIS C60068-2-78/MIL-STD-202 Method 103)	外観 Appearance	異常なきこと No Damage
			接触抵抗 Contact Resistance	60 milliohm MAXIMUM
			耐電圧 Dielectric Strength	4-1-3項満足のこと Must meet 4-1-3
			絶縁抵抗 Insulation Resistance	20 Megohm MINIMUM

REVISE ON PC ONLY

A

SEE SHEET 1 OF 19

TITLE:

0.5 FPC CONN. ZIF E/O (Hgt=1.9mm)
2 CONTACTS TYPE

THIS DOCUMENT CONTAINS INFORMATION THAT IS PROPRIETARY TO MOLEX ELECTRONIC TECHNOLOGIES, LLC AND SHOULD NOT BE USED WITHOUT WRITTEN PERMISSION

REV.

DESCRIPTION

DOCUMENT NUMBER
5051100004

DOC. TYPE
PS

DOC. PART
000

CUSTOMER
GENERAL

SHEET
4 OF 19

項目 Item		条件 Test Condition	規格 Requirement	
4-3-8	温度サイクル Temperature Cycling	適合FPCを嵌合させ、-55±3℃に30分、+125±2℃に30分、これを1サイクルとし、5サイクル繰り返す。但し、温度移行時間は、5分以内とする。試験後1～2時間室温に放置する。 (JIS C60068-2-14) Mate applicable FPC, exposing to 125+/-2 degree C and -55+/-3 degree C temperature extremes for 30 minutes each including a 0-5 minutes transition time. The above-mentioned condition is repeated 5cycles. After the test, allowed to stand at the room temperature for 1 to 2 hours before checking functionality. (JIS C60068-2-14)	外観 Appearance	異常なきこと No Damage
			接触抵抗 Contact Resistance	60 milliohm MAXIMUM
4-3-9	塩水噴霧 Salt Spray	適合するFPCを嵌合させ、35±2℃にて、重量比 5±1% の塩水を48時間噴霧し、試験後常温で水洗いした後、室温で乾燥させる。 (JIS C60068-2-11/MIL-STD-202 試験方法 101) Mate applicable FPC, exposing to the atmosphere where salt mist is diffused in. Other condition is written below. NaCl solution : 5+/-1% by weight Temperature : 35+/-2 degree C Duration : 48 hours After the test, they should be washed well by water and dried at room temperature before checking functionality. (JIS C60068-2-11/MIL-STD-202 Method 101)	接触抵抗 Contact Resistance	60 milliohm MAXIMUM
4-3-10	亜硫酸ガス SO ₂ Gas	適合するFPCを嵌合させ、40±2℃、50±5ppmの亜硫酸ガス中に24時間放置する。 Mate applicable FPC, exposing to the atmosphere is written below. Gas Concentration : SO ₂ =50+/-5ppm Temperature : 40+/-2 degree C Duration : 24hours	接触抵抗 Contact Resistance	60 milliohm MAXIMUM

REVISE ON PC ONLY		TITLE: 0.5 FPC CONN. ZIF E/O (Hgt=1.9mm) 2 CONTACTS TYPE
A	SEE SHEET 1 OF 19	
REV.	DESCRIPTION	THIS DOCUMENT CONTAINS INFORMATION THAT IS PROPRIETARY TO MOLEX ELECTRONIC TECHNOLOGIES, LLC AND SHOULD NOT BE USED WITHOUT WRITTEN PERMISSION

DOCUMENT NUMBER 5051100004	DOC. TYPE PS	DOC. PART 000	CUSTOMER GENERAL	SHEET 5 OF 19
-------------------------------	-----------------	------------------	---------------------	------------------

項目 Item		条件 Test Condition	規格 Requirement	
4-3-11	半田付け性 Solder Ability	端子先端より0.2mm、金具先端より0.2mmの位置まで、245±5℃のはんだに3±0.5秒浸す。 Dip the position of mm from terminal tip and 0.2mm from fitting nail tip into 245 +/-5 degree C solder for 3+/-0.5 seconds.	濡れ性 Solder Wetting	浸漬面積の95%以上 95% of immersed area must show no voids, pin holes
4-3-12	半田耐熱性 Resistance to Soldering Heat	(赤外線リフロー時 Infrared Reflow Method 第8項参照 Refer to the paragraph 8	外観 Appearance	端子ガタ、割れ等 異状無き事 No Damage
		(手半田時 Soldering iron method 端子先端より0.2mm、金具先端より0.2mmの位置まで350±10℃のはんだゴテにて3秒加熱する。 但し、異常な加圧のないこと。 Heat the position of 0.2mm from terminal tip and 0.2mm from fitting nail tip for 3 seconds with 350+/-10 degree C soldering iron. However, without too much pressure to the terminal pin and fitting nail.		

() : 参考規格 Reference Standard
{ } : 参考単位 Reference Unit

【5. 外観形状・寸法・材質 PRODUCT SHAPE, DIMENSIONS, MATERIALS】

図面参照 Refer to the drawing.

【6. 環境指令への適合 COMPLIANCE WITH ENVIRONMENTAL DIRECTIVE】

ELV及びRoHS適合品 ELV and RoHS compliant

REVISE ON PC ONLY		TITLE:			
A	SEE SHEET 1 OF 19	0.5 FPC CONN. ZIF E/O (Hgt=1.9mm) 2 CONTACTS TYPE			
	REV.	DESCRIPTION	THIS DOCUMENT CONTAINS INFORMATION THAT IS PROPRIETARY TO MOLEX ELECTRONIC TECHNOLOGIES, LLC AND SHOULD NOT BE USED WITHOUT WRITTEN PERMISSION		
DOCUMENT NUMBER 5051100004		DOC. TYPE PS	DOC. PART 000	CUSTOMER GENERAL	SHEET 6 OF 19

【7. FPC保持力 FPC RETENTION FORCE】

7-1 FPC耳付きを使用した際の参考値

下記に示した表は、0.3mm厚のFPCを使用したときのFPC保持力のデータを示しております。ただし、FPCの仕様がFPC保持力に影響を与えるため、下記に示したFPC保持力の仕様を満たさない場合があります。

注意: 以下表中の数値は参考値です。

Table shown below is a data of FPC retention force when using a thickness of 0.3mm FPC. But, there's a case which FPC retention force doesn't fulfill the specification shown below, because FPC specification affects the result of FPC retention force.

Notice: This chart shows reference value.

極数 No of CIRCUIT	単位 UNIT	保持力(最小値) Retention Force (MINIMUM)	
		初回 1 st	10回 10 th
20	N	12.4	4.5
22	N	12.7	4.9
24	N	12.9	5.4
26	N	13.2	5.9
28	N	13.4	6.3
30	N	13.7	6.7
35	N	14.5	7.8
40	N	14.9	9.0
45	N	15.5	10.1
50	N	16.2	11.2
60	N	17.5	13.5
64	N	17.6	14.4
70	N	18.7	15.8
80	N	20.0	18.0

REVISE ON PC ONLY		TITLE:			
A	SEE SHEET 1 OF 19	0.5 FPC CONN. ZIF E/O (Hgt=1.9mm) 2 CONTACTS TYPE			
		THIS DOCUMENT CONTAINS INFORMATION THAT IS PROPRIETARY TO MOLEX ELECTRONIC TECHNOLOGIES, LLC AND SHOULD NOT BE USED WITHOUT WRITTEN PERMISSION			
REV.	DESCRIPTION				
DOCUMENT NUMBER 5051100004		DOC. TYPE PS	DOC. PART 000	CUSTOMER GENERAL	SHEET 7 OF 19

7-2 FPC耳無しを使用した際の参考値

下記に示した表は、0.3mm厚のFPCを使用したときのFPC保持力のデータを示しております。ただし、FPCの仕様がFPC保持力に影響を与えるため、下記に示したFPC保持力の仕様を満たさない場合があります。

注意: 以下表中の数値は参考値です。

Table shown below is a data of FPC retention force when using a thickness of 0.3mm FPC. But, there's a case which FPC retention force doesn't fulfill the specification shown below, because FPC specification affects the result of FPC retention force.

Notice: This chart shows reference value.

極数 No of CIRCUIT	単位 UNIT	保持力(最小値) Retention Force (MINIMUM)	
		初回 1 st	10回 10 th
20	N	6.5	3.9
22	N	6.8	4.1
24	N	7.1	4.3
26	N	7.4	4.4
28	N	7.7	4.6
30	N	8.1	4.8
35	N	8.9	5.3
40	N	9.6	5.8
45	N	10.4	6.2
50	N	11.2	6.7
60	N	12.7	7.6
64	N	13.3	8.0
70	N	14.3	8.6
80	N	15.8	9.5

REVISE ON PC ONLY		TITLE:		
A	SEE SHEET 1 OF 19	0.5 FPC CONN. ZIF E/O (Hgt=1.9mm) 2 CONTACTS TYPE		
		THIS DOCUMENT CONTAINS INFORMATION THAT IS PROPRIETARY TO MOLEX ELECTRONIC TECHNOLOGIES, LLC AND SHOULD NOT BE USED WITHOUT WRITTEN PERMISSION		
REV.	DESCRIPTION	DOC. TYPE	DOC. PART	CUSTOMER
		PS	000	GENERAL
DOCUMENT NUMBER 5051100004				SHEET 8 OF 19

【 8. 赤外線リフロー条件 INFRARED REFLOW CONDITION】

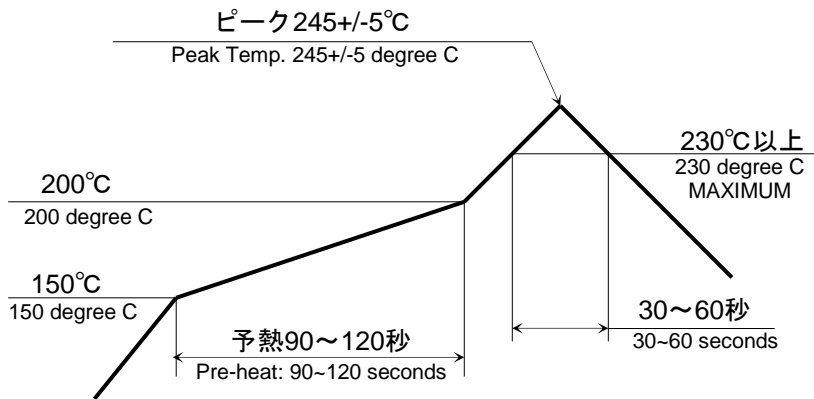

温度条件グラフ
TEMPERATURE CONDITION GRAPH

半田接合部の基板表面にて測定

(Temperature is measured at the soldering area on the surface of the print circuit board)

注記：本リフロー条件に関しては、温度プロファイル、半田ペースト、大気、N₂リフロー、基板などにより条件が異なりますので事前に実装評価（リフロー評価）を必ず実施願います。実装条件によっては、製品性能に影響を及ぼす場合があります。

NOTE: Please investigate the mounting condition (reflow soldering condition) on your own devices beforehand. The mounting conditions may change due to the soldering temperature, soldering paste, air reflow machine, Nitrogen reflow machine, and the type of printed circuit board. The different mounting conditions may have an influence on the product's performance.

REVISE ON PC ONLY		TITLE:			
A	SEE SHEET 1 OF 19	0.5 FPC CONN. ZIF E/O (Hgt=1.9mm) 2 CONTACTS TYPE			
	REV.	DESCRIPTION	THIS DOCUMENT CONTAINS INFORMATION THAT IS PROPRIETARY TO MOLEX ELECTRONIC TECHNOLOGIES, LLC AND SHOULD NOT BE USED WITHOUT WRITTEN PERMISSION		
DOCUMENT NUMBER 5051100004		DOC. TYPE PS	DOC. PART 000	CUSTOMER GENERAL	SHEET 9 OF 19

【9. 注意事項 NOTES】

9-1 外観

9-1-1

本製品の樹脂部に黒点、ウエルド部の線、多少の傷が確認される事がありますが、製品性能には影響ございません。
Although this product may have a small black mark, a weld line or a scratch on the housing, these will not have any influence on the product's performance.

9-1-2

本製品のネイルは錫めっきを使用しているため、外観に摺動痕がつく場合が御座いますが、製品性能に影響はありません。
Because we plate the fitting nails with Tin, there may be scratch marks on the surface. However, these scratches will have no influence on the product's performance.

9-1-3

成形品の色相に多少の違いを生じる場合がありますが、製品性能には影響ありません。
There may be slight differences in the housing coloring, but there will be no influence on the product's performance.

9-1-4

アクチュエータに潤滑剤が乾いた時に起こる白い部分が発生することがありますが、製品性能に影響ありません。
You may find the white dot on the actuator when the lubricant becomes dry, this will not affect the product's performance.

9-1-5

紫外線によりアクチュエータが変色する場合がありますが、製品性能に影響ありません。
Although the ultraviolet light may potentially change the actuator color, this change has no on the product's performance.

9-2 実装

9-2-1

実装性能(平坦度)は、実装基板の反りの影響を含まないものと致します。基板の反りはコネクタ両端部を基準とし、コネクタ中央部にて Max0.02mmとして下さい。

The mounting specification for coplanarity does not include the influence of warpage of the printed circuit board. The warpage of the printed circuit board should be a maximum of 0.02mm if measuring from one connector edge to the other.

9-2-2

本製品の一般性能確認はリジット基板にて実施おります。フレキシブル基板等の特殊な基板へ実装する場合は、事前に実装確認等を行った上でご使用願います。

The product performance was tested using rigid printed circuit board. In case the product needs to be reflowed onto flexible circuit board, please conduct a reflow test on the flexible circuit board in advance.

9-2-3

フレキシブル基板に実装する場合は、基板の変形を防止するため、補強板をご使用願います。

Please add a stiffener on the flexible printed circuit (FPC) when you mount the connector onto FPC in order to prevent deformation of the FPC.

A	REVISE ON PC ONLY	TITLE: 0.5 FPC CONN. ZIF E/O (Hgt=1.9mm) 2 CONTACTS TYPE		
	SEE SHEET 1 OF 19	THIS DOCUMENT CONTAINS INFORMATION THAT IS PROPRIETARY TO MOLEX ELECTRONIC TECHNOLOGIES, LLC AND SHOULD NOT BE USED WITHOUT WRITTEN PERMISSION		
REV.	DESCRIPTION	DOC. TYPE PS	DOC. PART 000	CUSTOMER GENERAL
DOCUMENT NUMBER 5051100004				SHEET 10 OF 19
EN-127(2015-12)				

9-2-4

リフロー条件によっては、樹脂部の変色が発生する場合がありますが、製品性能に影響はございません。
Depending on the reflow conditions, there may be the possibility of a color change in the housing. However, this color change does not have any effect on the product's performance.

9-2-5

リフロー後、半田付け部に変色が見られることがありますが、製品性能に影響はありません。
Although there might be some discoloration seen on the soldering tail after reflow, this will not influence the product's performance.

9-2-6

半田実装部の未半田は、ターミナル脱落、ピン間ショート、ターミナル座屈、またコネクタの基板からの外れが懸念されます。従って全てのターミナルテール部及び、ネイル部に半田付けを行って下さい。
If you leave any soldering area on this product open, there may be the possibility of a missing terminal short circuiting between pins, terminal buckling or the potential for the connector to come off of the printed circuit board. Therefore, please solder all of the terminals and fitting nails on the printed circuit board.

9-2-7

実装機によってコネクタに負荷が加わると変形、破損する場合がありますので事前にご確認下さい。
If there is accidental contact with the connector while it is going through the reflow machine, there may be deformation or damage caused to the connector. Please check to prevent this.

9-2-8

本製品のアクチュエータ材料は耐熱性ナイロンを使用しており、アクチュエータの吸水状態、或いは、はんだ付け条件によっては、リフローはんだ付け時にアクチュエータ表面に「ふくれ」が発生する可能性があります。この「ふくれ」に関しましては、ナイロン材の物性変化を伴うものではなく、製品機能を損なうものではありません。
The actuator material of this product is made from a high heat resistant Nylon. The soldering condition and the water absorption properties of the actuator material may cause blistering on the actuator surface. Because this blister is not caused by property change, it does not damage the product's features.

9-2-9

本製品はリフロー回数2回を保証しております。リフロー2回目は基板上向きでの保証をしており、2回目基板下向きを行う際には別途評価が必要となりますので御連絡願います。
Reflow possibility is 2times.
This product guarantees mounting on upper side of printed circuit board on the second reflow.
The evaluation is separately needed when it mount with lower side of printed circuit board on the second reflow.

9-3 製品仕様

9-3-1

コネクタの性能を損なう恐れがある為、コネクタの洗浄は、行わないで下さい。
Please do not conduct any "washing process" on the connector because it may damage the product's function.

9-3-2

適合するFPCの導体部は、金めっき(ニッケル下地)品を使用願います。
Please make sure to use the appropriate FPC which has Gold plating (Nickel under plating) on the contact area.

9-3-3

量産前にご使用になるFPCとの相性確認を行った上で、ご使用をお願い致します。
Please check the compatibility between the connector and the FPC prior to moving to mass production.

REVISE ON PC ONLY		TITLE:			
A	SEE SHEET 1 OF 19	0.5 FPC CONN. ZIF E/O (Hgt=1.9mm) 2 CONTACTS TYPE			
	REV.	DESCRIPTION	THIS DOCUMENT CONTAINS INFORMATION THAT IS PROPRIETARY TO MOLEX ELECTRONIC TECHNOLOGIES, LLC AND SHOULD NOT BE USED WITHOUT WRITTEN PERMISSION		
DOCUMENT NUMBER 5051100004		DOC. TYPE PS	DOC. PART 000	CUSTOMER GENERAL	SHEET 11 OF 19
EN-127(2015-12)					

9-3-4

コネクタにFPCを装着した状態で、FPCに過度の負荷が加わらないようにご注意ください、御社基板のスペース上、コネクタに負担の掛かる位置への取り付けはしないで下さい。コネクタのロックが解除されたり、FPCの抜け、断線、破損や接触不良の原因になります。特に、連続的に加わる場合はFPCを固定するようにして下さい。また、基板に対して垂直上下方向の引張荷重、コンタクトピッチ方向のこじり荷重を与えない様にご注意願います。Please pay special attention not to have any pulling force/tension on the FPC when it is inserted into the connector. This can cause; the actuator to be unlocked, the actuator to come off, cut the traces on the FPC, and/or damage the FPC. Please be especially careful to avoid placing the FPC in a location where it will have a constant force applied on the FPC. If necessary, please fix the FPC directly on the chassis. Also, please avoid pulling the FPC vertically or twisting the FPC back and force horizontally while it is inserted in the connector.

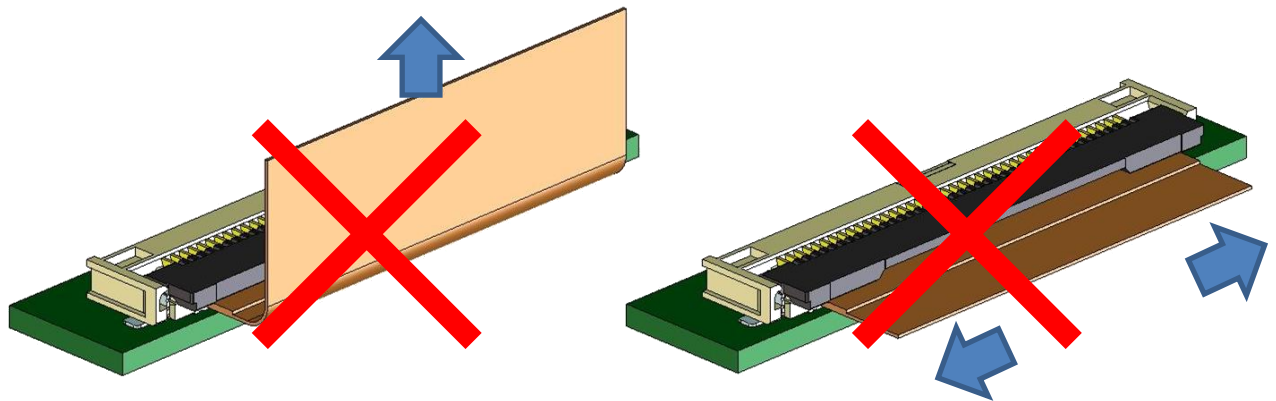

9-3-5

本製品をご使用時に取り付けられた電線・プリント基板の共振や、機器の回転構造や可動部分の動作によりコネクタ嵌合部（接点部）が常に動いてしまう状態での御使用は避けて下さい。接触部の摺動磨耗等による 接触不良の原因となります。従って、機器内で電線・プリント基板を固定し、共振を抑える等の処置をお願い致します。

Please do not use the connector in a condition where the wire, the printed circuit board, or the contact area is experiencing a sympathetic vibration of wires and printed circuit board, and constant movement of devices. This may cause a defect in the contact due to the contact area being worn down. Therefore, please fix wires and printed circuit board on the chassis, and reduces sympathetic vibration.

9-3-6

活電状態の電気回路で、挿入、抜去ができることを前提に作られていません。スパーク等による危険の発生、性能不良につながりますので、活電状態での挿入、抜去はしないで下さい。

This product is not designed for the mating and unmating of the connectors to be performed under the condition of an active electrical circuit. It may cause a spark and product defect if the connectors are mated and unmated in this way.

9-3-7

コネクタに外力が加わらないようにクリアランスをあげた筐体構造にして下さい。

Please keep enough clearance between connector and chassis of your application in order not to apply pressure on the connector.

9-3-8

基板実装後に基板を直接積み重ねない様に注意してください。

Please do not stack the printed circuit board directly after mounted the connector on it.

REVISE ON PC ONLY		TITLE:		
A	SEE SHEET 1 OF 19	0.5 FPC CONN. ZIF E/O (Hgt=1.9mm) 2 CONTACTS TYPE		
REV.	DESCRIPTION	THIS DOCUMENT CONTAINS INFORMATION THAT IS PROPRIETARY TO MOLEX ELECTRONIC TECHNOLOGIES, LLC AND SHOULD NOT BE USED WITHOUT WRITTEN PERMISSION		
DOCUMENT NUMBER 5051100004		DOC. TYPE PS	DOC. PART 000	CUSTOMER GENERAL
				SHEET 12 OF 19
EN-127(2015-12)				

9-3-9

FFCに規定された定格温度がFFC単体前提の場合がございます。

この時、コネクタと組み合わせての実使用において、FFC導体の接着層が劣化する等の信頼性を満足できないケースを回避する為、実機での評価/確認をお願い致します。

There is a possibility that the prescript temperature of FFC is set to single it.

When actually using it with connector, Please do the evaluation and the confirmation wiyh an actual equipment to evade the case where reliability cannot be filled (the adhesive line od FFC is deteriorated etc)

	REVISE ON PC ONLY		TITLE:		
	A	SEE SHEET 1 OF 19	0.5 FPC CONN. ZIF E/O (Hgt=1.9mm) 2 CONTACTS TYPE		
	REV.	DESCRIPTION	THIS DOCUMENT CONTAINS INFORMATION THAT IS PROPRIETARY TO MOLEX ELECTRONIC TECHNOLOGIES, LLC AND SHOULD NOT BE USED WITHOUT WRITTEN PERMISSION		
DOCUMENT NUMBER 5051100004		DOC. TYPE PS	DOC. PART 000	CUSTOMER GENERAL	SHEET 13 OF 19
EN-127(2015-12)					

9-4 製品操作

9-4-1

基板実装前後に端子、補強金具に触らないでください。

Please do not touch the terminals and fitting nails before or after reflowing the connector onto the printed circuit board.

9-4-2

FPC挿入する際は、アクチュエータが完全に開いた状態で行い、FPCがハウジングに突き当たるまで挿入し、FPCの耳がコネクタ位置決め部に確実に収まっていることをご確認下さい。左右斜めの状態で挿入すると、ピッチずれによるショート不良になったり、角がターミナルに引っ掛かりターミナルの変形やFPC導体めくれに至るケースがあります。

When inserting the FPC into the connector, please ensure that the actuator is completely open during insertion. Please also ensure that the FPC is completely inserted until the end of the FPC touches the housing and that the FPC ear is positioned correctly. Diagonal insertion of the FPC into the connector can cause a short circuit due to the misaligned pitch. Diagonal insertion can also deform the terminal and/or damage the FPC contact area because the FPC edge may contact the terminal.

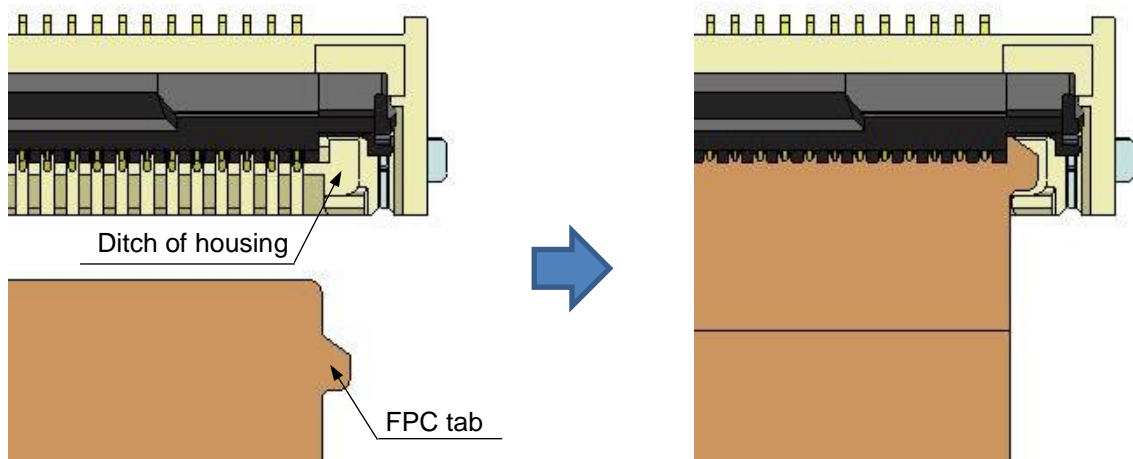
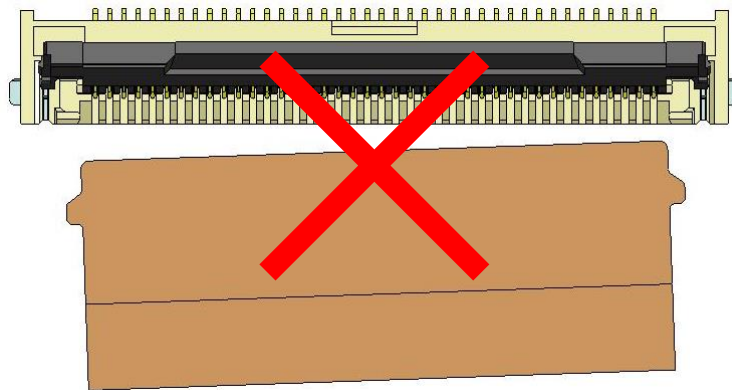

REVISE ON PC ONLY		TITLE:		
A	SEE SHEET 1 OF 19	0.5 FPC CONN. ZIF E/O (Hgt=1.9mm) 2 CONTACTS TYPE		
REV.	DESCRIPTION	THIS DOCUMENT CONTAINS INFORMATION THAT IS PROPRIETARY TO MOLEX ELECTRONIC TECHNOLOGIES, LLC AND SHOULD NOT BE USED WITHOUT WRITTEN PERMISSION		
DOCUMENT NUMBER 5051100004		DOC. TYPE PS	DOC. PART 000	CUSTOMER GENERAL
				SHEET 14 OF 19
EN-127(2015-12)				

9-4-3

アクチュエータ操作時にはピンセット等の先端が鋭利な物は使用しないで下さい。コネクタの破損、半田付け部の損傷の原因になります。

When opening and closing the actuator, please do not use a sharp edged tool such as tweezers. This may cause to damage the connector or to the soldering area.

9-4-4

アクチュエータを開閉する際は、左右均等に力が加わるように中央部を回転させて丁寧に操作する様に、お願いします。荷重が一点に集中するような片側に偏った位置での操作は行わないで下さい。コネクタの破損の原因になります。

When opening and closing the actuator, please gently pull the center of the actuator by applying an even force across the actuator and rotating carefully. Please do not apply a force only to one side of actuator because it may cause to damage the connector.

A	REVISE ON PC ONLY	TITLE: 0.5 FPC CONN. ZIF E/O (Hgt=1.9mm) 2 CONTACTS TYPE			
	SEE SHEET 1 OF 19				
	REV.	DESCRIPTION	THIS DOCUMENT CONTAINS INFORMATION THAT IS PROPRIETARY TO MOLEX ELECTRONIC TECHNOLOGIES, LLC AND SHOULD NOT BE USED WITHOUT WRITTEN PERMISSION		
DOCUMENT NUMBER 5051100004		DOC. TYPE PS	DOC. PART 000	CUSTOMER GENERAL	SHEET 15 OF 19
EN-127(2015-12)					

9-4-5

アクチュエータを閉じる際は、下図 **OK** のようにアクチュエータ角度が90°以下になるまでは基板と平行方向に押しアクチュエータを回転させ、90°以下になりましたらアクチュエータを押さえる方向の力を加えるように行って下さい。また、下図 **NG** の様にアクチュエータ軸方向に過度の力を加えながらの閉じ動作は行わないようにして下さい。

Close the actuator, seeing following figures.

Actuator open-angle is...

90 degrees or more. : Add force in the direction parallel to the P.C. board.

Less than 90 degrees. : Add force in the direction of the P.C. board (direction of closing actuator).

Do not manipulate it, adding extra force to actuator's axis of rotation.

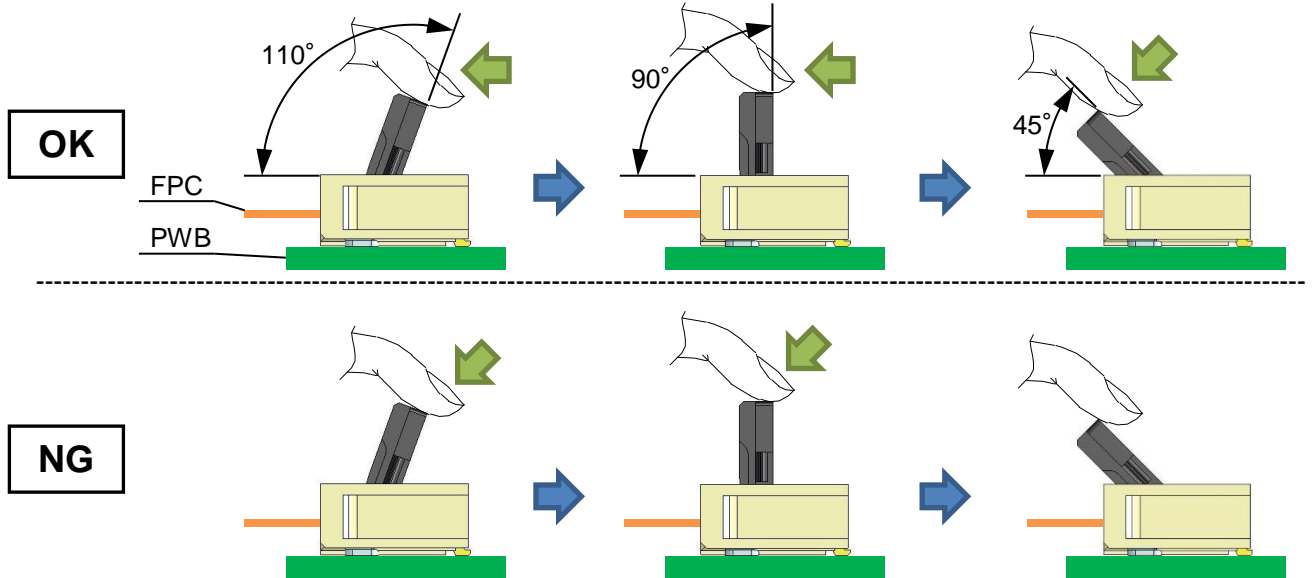

● ロック操作について

About the lock operation

ロック時はアクチュエータの中央で行うことを推奨します。アクチュエータを閉じた後は、下図のようにアクチュエータを確実にロックする為に表面を軽く押さえて下さい

When you lock, it is recommended to do on center of the actuator. After the actuator is closed, please apply soft pressure to ensure that the actuator is completely locked (as shown in figure below)

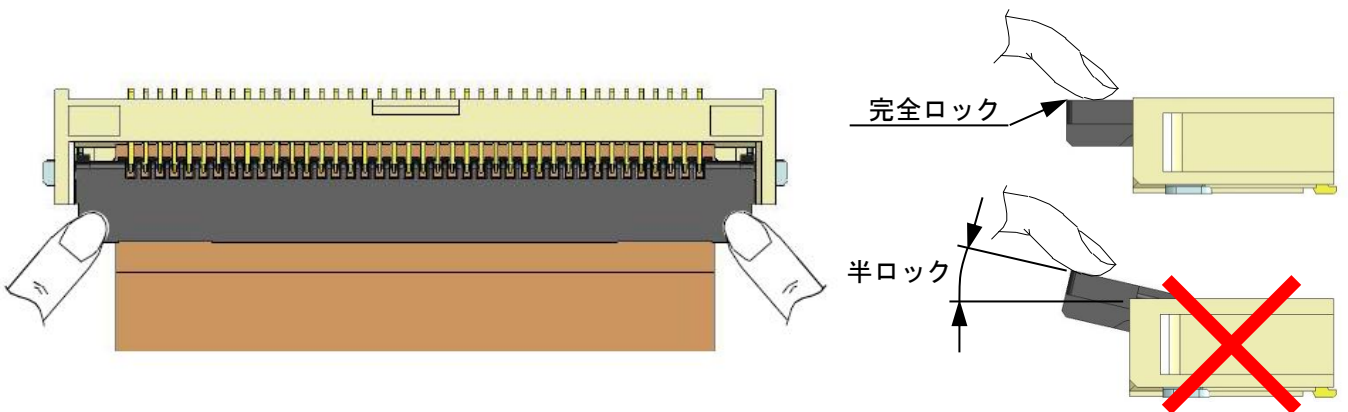

REVISE ON PC ONLY		TITLE:		
A	SEE SHEET 1 OF 19	0.5 FPC CONN. ZIF E/O (Hgt=1.9mm) 2 CONTACTS TYPE		
REV.	DESCRIPTION	THIS DOCUMENT CONTAINS INFORMATION THAT IS PROPRIETARY TO MOLEX ELECTRONIC TECHNOLOGIES, LLC AND SHOULD NOT BE USED WITHOUT WRITTEN PERMISSION		
DOCUMENT NUMBER 5051100004		DOC. TYPE PS	DOC. PART 000	CUSTOMER GENERAL
				SHEET 16 OF 19
EN-127(2015-12)				

9-4-6

アクチュエータのロックを解除する際は、アクチュエータの左右へ均等に力が加わるように、上方向へ押し上げて下さい。押し上げの際には、中央部を跳ね上げるように操作願います。アクチュエータが回転運動をして開きます。また、アクチュエータが変形及び破壊する方向（開く方向）への過大な負荷を掛けない様にご注意下さい。破損・外れの原因となります。

When unlocking the actuator, please pull up on the center of actuator in the direction of actuator rotation, which delivers even force to both edges of actuator. Please do not apply any force in any other direction as this may deform or damage the actuator.

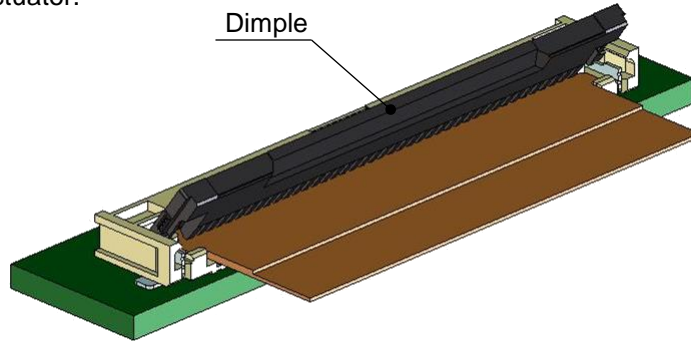

9-4-7

FPCを抜く時は、アクチュエータが完全に開いた状態で行って下さい。万が一、アクチュエータが完全に開いていない状態でFPCを抜いた時は、コンタクト部に付着物が無いか確認の上、再装着願います。

When withdrawing the FPC, please make sure that the actuator is completely open. If the FPC is withdrawn without the actuator being fully open, please check to make sure that there is no debris on the contact area before inserting the FPC again.

9-4-8

嵌合後、コネクタピッチ方向、スパン方向及び回転方向への負荷がかかるような動作またはセットはしないでください。コネクタ破壊やはんだクラックを引き起こします。

After mated the connector, please do not allow the printed circuit boards to apply pressure on the connector in either the pitch direction or the span direction. It may cause damage to the connector and may crack the soldering.

9-4-9

本製品のアクチュエータは回転しながら開く構造となっています。その為、アクチュエータ軸方向に過度の力を加えながらの開き動作は行わないようにして下さい。アクチュエータ開き途中での引っ掛かりや、コネクタ破損等の原因となる場合があります。アクチュエータを開ける操作は中央の切り欠き部を押し上げるように行って下さい。

It opens as the actuator is rotating. Therefore do not manipulate to add extra force only to the FPC insertion direction because the actuator may stop and break. Operation of opening actuator: Push up dimple of actuator.

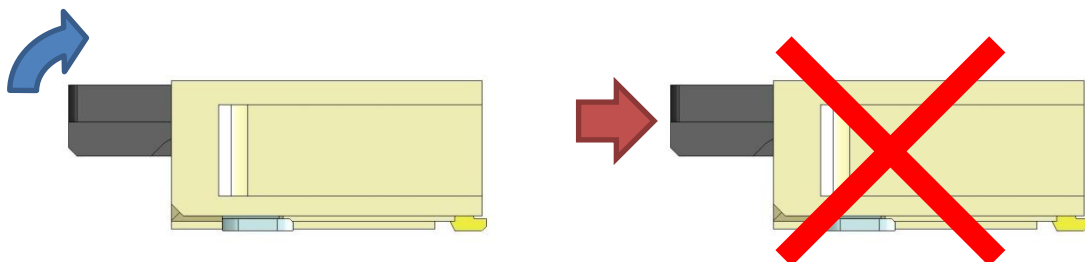

REVISE ON PC ONLY		TITLE:		
A	SEE SHEET 1 OF 19	0.5 FPC CONN. ZIF E/O (Hgt=1.9mm) 2 CONTACTS TYPE		
REV.	DESCRIPTION	THIS DOCUMENT CONTAINS INFORMATION THAT IS PROPRIETARY TO MOLEX ELECTRONIC TECHNOLOGIES, LLC AND SHOULD NOT BE USED WITHOUT WRITTEN PERMISSION		
DOCUMENT NUMBER 5051100004		DOC. TYPE PS	DOC. PART 000	CUSTOMER GENERAL
				SHEET 17 OF 19
EN-127(2015-12)				

9-4-10

FPCを嵌合させる際、FPCをたわませて挿入しないで下さい。また、水平基板面に対し斜めからの挿入もしないで下さい。コンタクトの挫屈、FPC導体めくれに至るケースがあります。

When you mate the FPC into connector, please avoid to bow down the FPC and avoid to inset FPC diagonally. It may cause a contact buckling and/or evert the conductor of FPC.

9-5 リペア

9-5-1

実装後において半田こてによる手修正を行う際は、必ず仕様書掲載の条件以内で行って下さい。

条件を超えて実施した場合、端子の抜け、接点ギャップの変化、モールドの変形、溶融等、破損の原因になります。

When conducting manual repairs using a soldering iron, please follow the soldering conditions shown in the product specification. If the conditions in the product spec are not followed, it may cause the terminals to fall off, a change in the contact gap, a deformation of the housing, melting of the housing, and damage the connector.

9-5-2

半田こてによる手修正を行なう際、過度の半田やフラックスを使用しないで下さい。

半田上がりやフラックス上がりにより接触、機能不良に至る場合があります。

When conducting manual repairs using a soldering iron, please do not use more solder and flux than needed. This may cause solder wicking and flux wicking issues, and it will eventually cause a contact defect and functional issues.

	REVISE ON PC ONLY		TITLE: 0.5 FPC CONN. ZIF E/O (Hgt=1.9mm) 2 CONTACTS TYPE			
	A	SEE SHEET 1 OF 19				
REV.	DESCRIPTION		THIS DOCUMENT CONTAINS INFORMATION THAT IS PROPRIETARY TO MOLEX ELECTRONIC TECHNOLOGIES, LLC AND SHOULD NOT BE USED WITHOUT WRITTEN PERMISSION			
DOCUMENT NUMBER 5051100004			DOC. TYPE PS	DOC. PART 000	CUSTOMER GENERAL	SHEET 18 OF 19
EN-127(2015-12)						

