

Aug.1.2018 Copyright 2018 HIROSE ELECTRIC CO., LTD. All Rights Reserved.
 In case that the application demands a high level of reliability, such as automotive,
 please contact a company representative for further information.

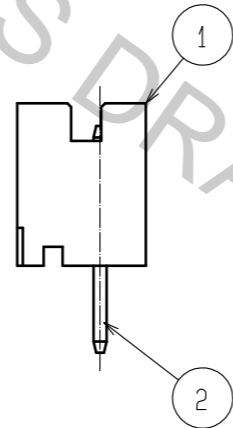

PART No.	CODE No.	NUMBER OF CONTACTS	A	B	C
DF13- 2P-1.25DSA(75)	CL536-0101-9-75	2	1.25	3.15	4.15
DF13- 3P-1.25DSA(75)	CL536-0102-1-75	3	2.5	4.4	5.4
DF13- 4P-1.25DSA(75)	CL536-0103-4-75	4	3.75	5.65	6.65
DF13- 5P-1.25DSA(75)	CL536-0104-7-75	5	5	6.9	7.9
DF13- 6P-1.25DSA(75)	CL536-0105-0-75	6	6.25	8.15	9.15
DF13- 7P-1.25DSA(75)	CL536-0106-2-75	7	7.5	9.4	10.4
DF13- 8P-1.25DSA(75)	CL536-0107-5-75	8	8.75	10.65	11.65
DF13- 9P-1.25DSA(75)	CL536-0108-8-75	9	10	11.9	12.9
DF13-10P-1.25DSA(75)	CL536-0109-0-75	10	11.25	13.15	14.15
DF13-11P-1.25DSA(75)	-	11	12.5	14.4	15.4
DF13-12P-1.25DSA(75)	CL536-0111-2-75	12	13.75	15.65	16.65
DF13-13P-1.25DSA(75)	CL536-0112-5-75	13	15	16.9	17.9
DF13-14P-1.25DSA(75)	CL536-0113-8-75	14	16.25	18.15	19.15
DF13-15P-1.25DSA(75)	CL536-0114-0-75	15	17.5	19.4	20.4

2 APPLICATION FIGURE

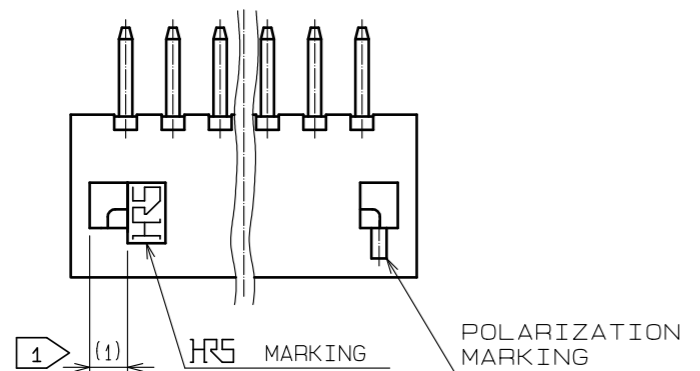
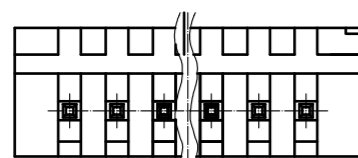
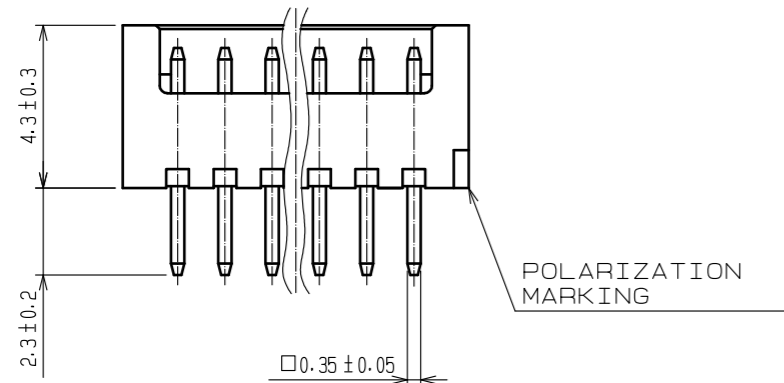
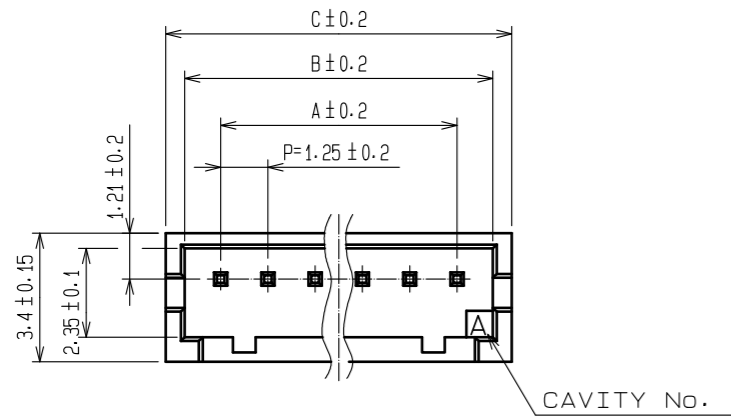
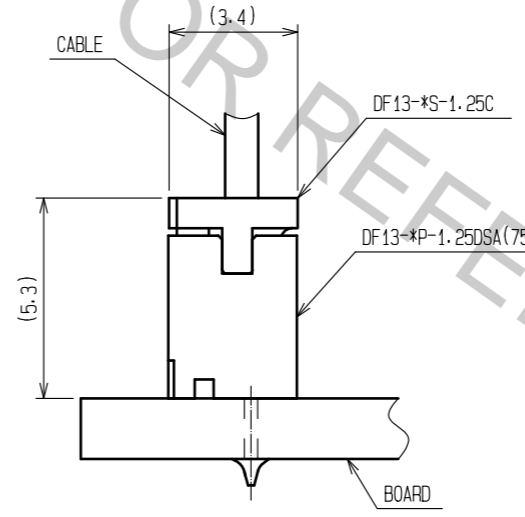

3 RECOMMENDED PATTERN

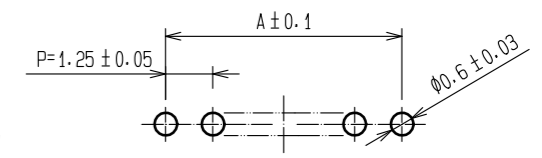

- 1 WHEN THIS CONNECTOR HAS TWO OR THREE CONTACTS, THE LOCK OF CONNECTOR SHALL BE SET AT THE CENTER OF HOUSING. IN CASE THAT THE NUMBER OF CONTACTS IS MORE THAN FOUR, THE TWO LOCKS SHALL BE SET IN ACCORDANCE WITH THE DRAWINGS.
- 2 WHEN THIS CONNECTOR MATES WITH DF13-*S-1.25C, THE MATING HEIGHT IS 5.3mm.
- 3 RECOMMENDED THROUGH HOLE DIA. : φ0.6 ± 0.03

2	BRASS	SURFACE:TIN PLATED 1μm min. UNDER PLATING:COPPER PLATED 1μm min	4	ELASTOMER	GREEN·STOPPER
1	POLYAMIDE	BEIGE(NATURAL)·UL94V-0	3	R·PVC	ANTI-ELECTRIFICATION·CLEAR·STICK
NO.	MATERIAL	FINISH, REMARKS	NO.	MATERIAL	FINISH, REMARKS
UNITS	mm	SCALE	5 : 1	COUNT	DESCRIPTION OF REVISIONS
APPROVED : HS. OKAWA		18.03.20		DRAWING NO. EDC-083673-75-00	
CHECKED : TS. FUKUSHIMA		18.03.20		PART NO. DF13-*P-1.25DSA(75)	
DESIGNED : TS. KUMAZAWA		18.03.19		CODE NO. CL536-	
DRAWN : MK. INOUE		18.03.08		1/2	

Aug.1.2018 Copyright 2018 HIROSE ELECTRIC CO., LTD. All Rights Reserved.
 In case that the application demands a high level of reliability, such as automotive,
 please contact a company representative for further information.

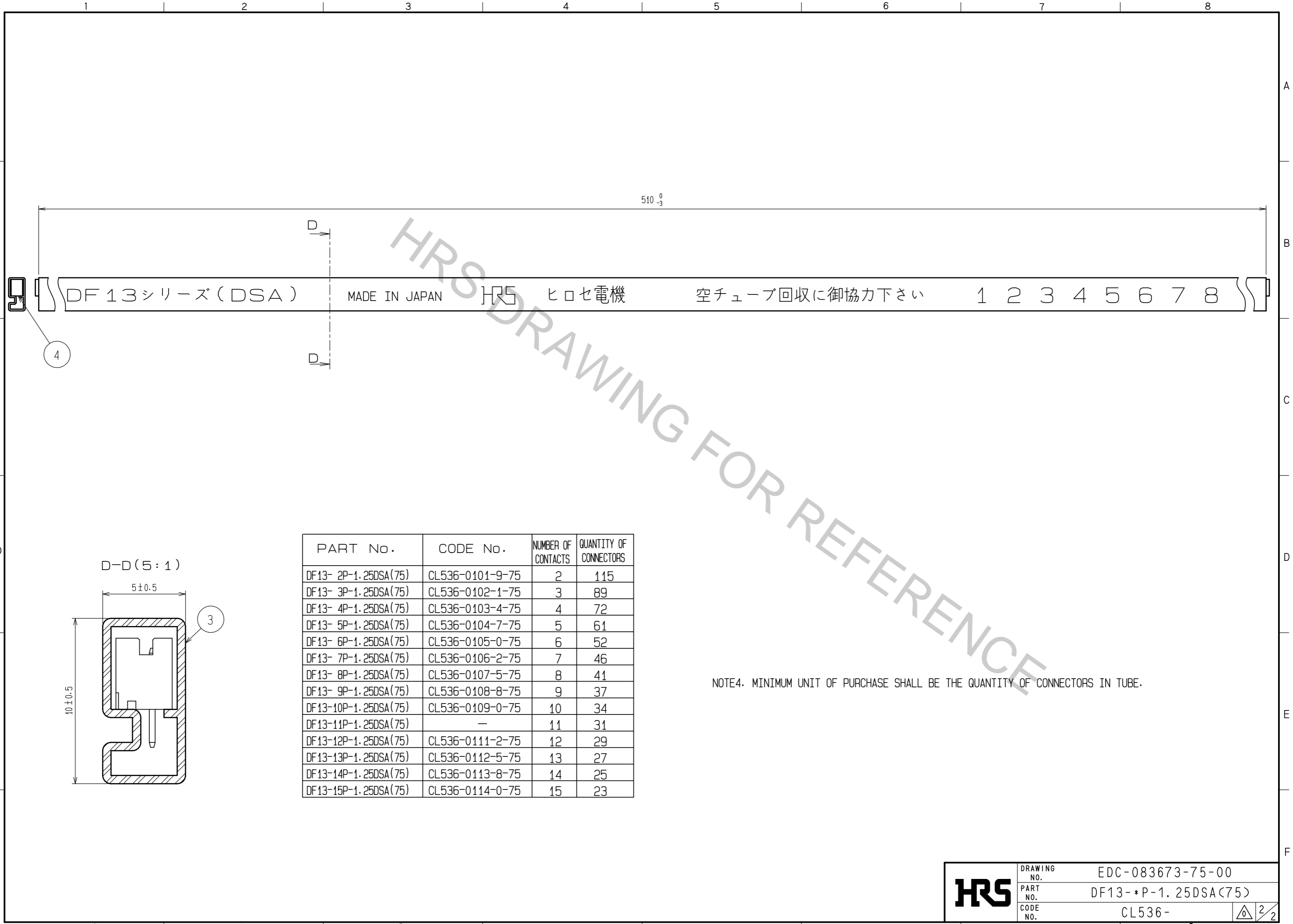

PART No.	CODE No.	NUMBER OF CONTACTS	QUANTITY OF CONNECTORS
DF13- 2P-1.25DSA(75)	CL536-0101-9-75	2	115
DF13- 3P-1.25DSA(75)	CL536-0102-1-75	3	89
DF13- 4P-1.25DSA(75)	CL536-0103-4-75	4	72
DF13- 5P-1.25DSA(75)	CL536-0104-7-75	5	61
DF13- 6P-1.25DSA(75)	CL536-0105-0-75	6	52
DF13- 7P-1.25DSA(75)	CL536-0106-2-75	7	46
DF13- 8P-1.25DSA(75)	CL536-0107-5-75	8	41
DF13- 9P-1.25DSA(75)	CL536-0108-8-75	9	37
DF13-10P-1.25DSA(75)	CL536-0109-0-75	10	34
DF13-11P-1.25DSA(75)	—	11	31
DF13-12P-1.25DSA(75)	CL536-0111-2-75	12	29
DF13-13P-1.25DSA(75)	CL536-0112-5-75	13	27
DF13-14P-1.25DSA(75)	CL536-0113-8-75	14	25
DF13-15P-1.25DSA(75)	CL536-0114-0-75	15	23

NOTE4. MINIMUM UNIT OF PURCHASE SHALL BE THE QUANTITY OF CONNECTORS IN TUBE.

HRS	DRAWING NO.	EDC-083673-75-00
	PART NO.	DF13-*P-1.25DSA(75)
	CODE NO.	CL536-
		2/2