

LT3518: Full-Featured LED Driver with 2.3A Switch Current

DESCRIPTION

Demonstration circuit 1160 is a full-featured LED driver with 2.3A switch current featuring the LT[®]3518. The board is optimized to drive a 330mA LED string with a total LED voltage between the input voltage and 40V in a boost topology. The high input voltage range, high efficiency low side internal 2.3A NPN power switch, low voltage floating current sense amplifier, soft-start, high side PMOS PWM gate driver, high PWM dimming ratio, overvoltage protection, shutdown control pin, analog LED current dimming control, and externally programmable switching frequency (with sync) make the LT3518 an extremely versatile and powerful LED driving IC.

The LT3518 has a 45V switch with 2.3A peak switch current limit rating. DC1160 has overvoltage protection at 40V if the LEDs are open or not properly attached to the terminals on the PCB. The shutdown function is activated by pulling the shutdown terminal to ground. In shutdown the boost configuration allows the input voltage to be seen on the output and if the attached LED array leaks current at the input voltage, the LEDs may not completely turn off. If the top gate is installed, it will provide shutdown output disconnect and the LEDs will turn off during shutdown. The CTRL terminal can be used to analog dim the LED current. In order to use the CTRL terminal, R6 (0 Ω) pull-up short resistor must be removed and replaced with a resistor divider from V_{REF} to GND or an external voltage on the CTRL terminal.

The high side PMOS PWM dimming MOSFET can be used to achieve 3000:1 PWM dimming ratio. The board is programmed for 1MHz oscillator frequency, but can be adjusted by changing R14. Higher frequency results in higher PWM dimming ratio.

The V_{IN} pin can be tied directly to PV_{IN} for simplicity or powered from an additional low voltage input such as 3.3V for higher efficiency operation and lower on-chip power dissipation.

A few simple modifications can be made to DC1160 in order to convert the board from a boost LED driver to a buck mode or buck-boost mode LED driver. Please consult the data sheet for schematic details and the factory for customization details.

The LT3518 data sheet gives a complete description of the part, operation and applications information. The data sheet must be read in conjunction with this Quick Start Guide for demonstration circuit 1160. The LT3518 is assembled in a small 16-lead plastic (4mm \times 4mm) QFN UF package with a thermally enhanced ground pad. Proper board layout is essential for maximum thermal performance. See the data sheet section Layout Considerations.

Design files for this circuit board are available at <http://www.linear.com/demo>

LT, LT, LTC, LTM, Linear Technology and the Linear logo are registered trademarks of Linear Technology Corporation. All other trademarks are the property of their respective owners.

QUICK START PROCEDURE

DC1160 is easy to set up to evaluate the performance of the LT3518. Follow the procedure below:

Note: Make sure that the PV_{IN} input voltage does not exceed 40V and that the V_{IN} input voltage does not exceed 30V.

1. Connect a string of LEDs with forward voltage less than 40V, but greater than the PV_{IN} input voltage, to the LED⁺ and GND terminals on the PCB as shown.
2. With power off, connect a 3.3V input power supply to the V_{IN} and GND terminals on the PCB.
3. With power off, connect a 3V to 40V input power supply to PV_{IN} and GND terminals on the PCB. PV_{IN} should not exceed the attached LED string voltage.
4. Connect a 3.3V source to PWM and GND.
5. Turn PV_{IN} power on.
6. Turn V_{IN} power on and observe the regulated LED current, the circuit efficiency, etc. without looking directly at the LEDs.
7. For PWM dimming, tie a 100Hz, 3V to 5V PWM waveform to the PWM terminal and GND and observe the PWM dimming LED current and PWM gate waveforms.
8. For shutdown, tie the \overline{SHDN} terminal to GND and observe the LED current dropping to zero and the V_{IN} input current dropping to about 65mA with R4 installed ($V_{IN}/51k$).

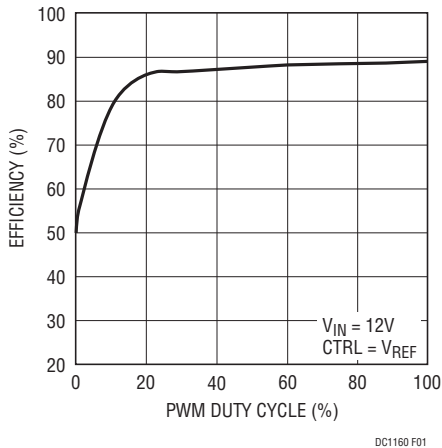

Figure 1. DC1160A Efficiency 30V LED String, $PV_{IN} = V_{IN} = 12V$

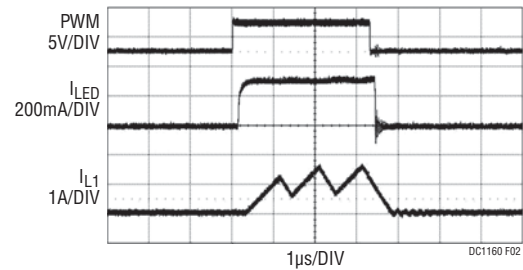

Figure 2. 3000:1 PWM Dimming at 100Hz, $PV_{IN} = 12V$, $V_{LED} = 30V$

QUICK START PROCEDURE

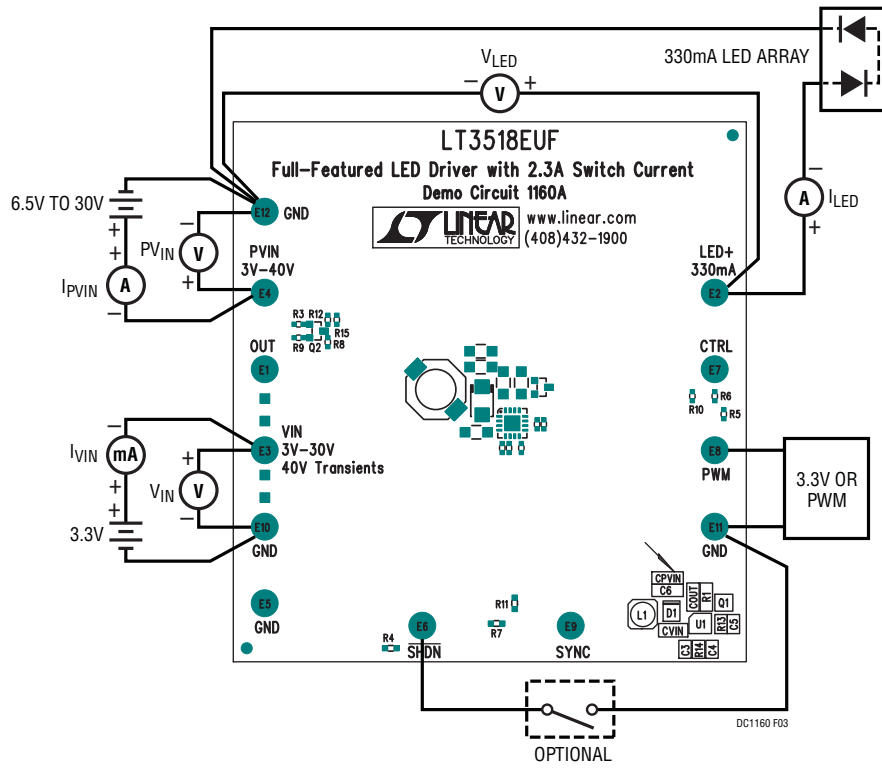

Figure 3. Proper Measurement Equipment Setup

DEMO MANUAL DC1160

PARTS LIST

ITEM	QUANTITY	REFERENCE	PART DESCRIPTION	MANUFACTURER, PART NUMBER
REQUIRED CIRCUIT COMPONENTS:				
1	1	C5	Capacitor, X7R, 4.7nF, 25V, 20% 0402	AVX, 04023C472MAT2A
2	2	C3,C4	Capacitor, X7R, 0.01µF, 16V, 10% 0402	AVX, 0402YC103KAT
3	1	C _{VIN}	Capacitor, X7R, 1µF, 50V, 10% 1206	Murata, GRM31MR71H105KA88L
4	2	C _{PVIN} , C _{OUT}	Capacitor, X5R, 2.2µF, 50V, 10% 1206	Murata, GRM31CR71H225KA88L
5	1	D1	Schottky Rectifier, 2.1A\60V, SMA	Vishay, 10MQ060NPBF
6	1	L1	Inductor, 10µH	Sumida, CDRH8D28-100NC
7	1	R1	Resistor, Chip, 0.300Ω, 1/4W, 1% 1206	Vishay, CRCW1206R300FNTA
8	1	R8	Resistor, Chip, 392k, 1/16W, 1% 0402	Vishay, CRCW0402392KFKED
9	1	R12	Resistor, Chip, 10k, 1/16W, 1% 0402	Vishay, CRCW040210K0FKED
10	1	R13	Resistor, Chip, 5.1k, 1/16W, 1% 0402	Vishay, CRCW04025K10FKEA
11	1	R14	Resistor, Chip, 16.5k, 1/16W, 1% 0402	Vishay, CRCW040216K5FKEA
12	1	U1	I.C., LT3518EUF	Linear Tech., LT3518EUF#PBF
ADDITIONAL DEMO BOARD CIRCUIT COMPONENTS:				
1	0	C1,C2,C6	OPT	
2	1	Q1	MOSFET, P-Channel 40-V (D-S) SOT23	Vishay, Si2319DS-T1-E3
3	2	R6, R7	Resistor, Chip, 0, 0402	Vishay, CRCW04020000Z0ED
4	1	R4	Resistor, Chip, 51k, 1/16W, 5% 0402	AAC, CR05-513JM
5	0	R2, R3, R5, R9-R11, R15, R16	OPT	
HARDWARE FOR DEMO BOARD ONLY:				
1	12	E1 to E12	Testpoint, Turret, 0.094"	Mill-Max, 2501-2

SCHEMATIC DIAGRAM

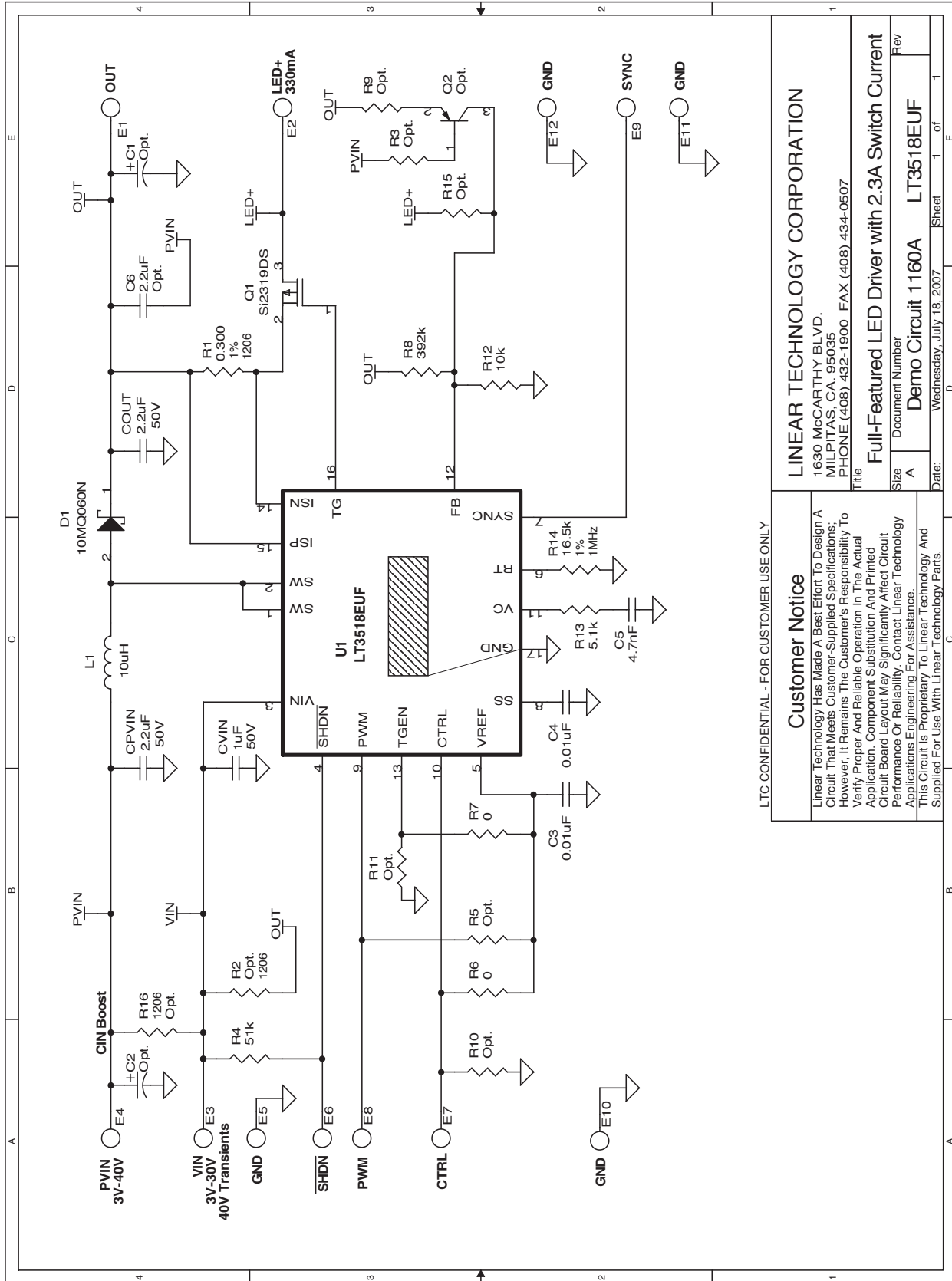

LTC CONFIDENTIAL - FOR CUSTOMER USE ONLY

Customer Notice

Linear Technology Has Made A Best Effort To Design A Circuit That Meets Customer-Supplied Specifications; However, It Remains The Customer's Responsibility To Verify Proper And Reliable Operation In The Actual Application. Component Substitution And Printed Circuit Board Layout May Significantly Affect Circuit Performance Or Reliability. Contact Linear Technology Applications Engineering For Assistance. This Circuit Is Proprietary To Linear Technology And Supplied For Use With Linear Technology Parts.

LINEAR TECHNOLOGY CORPORATION

1630 McCARTHY BLVD.
MILLPITAS, CA, 95035
PHONE (408) 432-1900 FAX (408) 434-0507

Full-Featured LED Driver with 2.3A Switch Current

Title	Document Number	Rev
Demo Circuit 1160A	LT3518EUF	
Date: Wednesday, July 18, 2007	Sheet 1 of 1	

ASSEMBLY DRAWINGS

Silkscreen Top

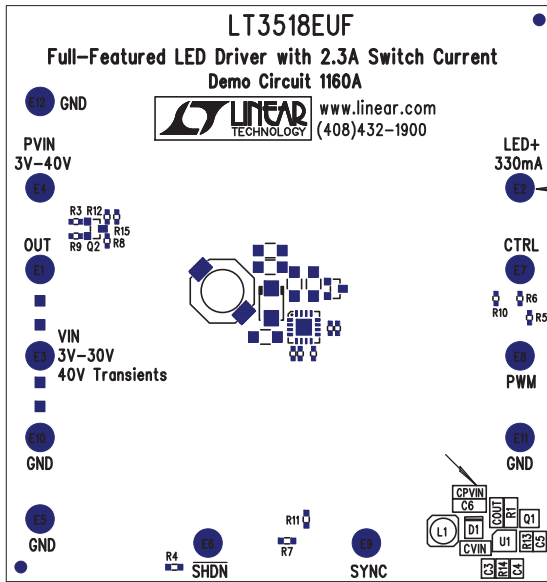

FOR ASSEMBLY:
Install Hardware (E1-E12)
At These Locations (Top Side Only)

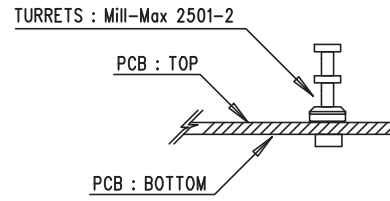

PCB LAYOUT AND FILM

Silkscreen Top

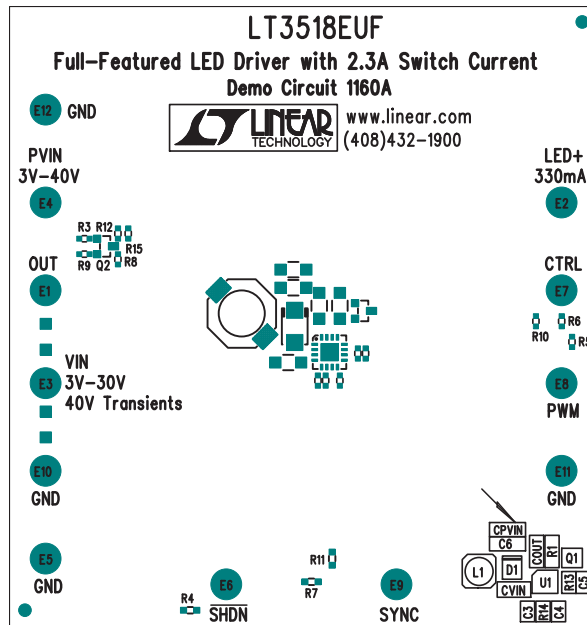

Component Side

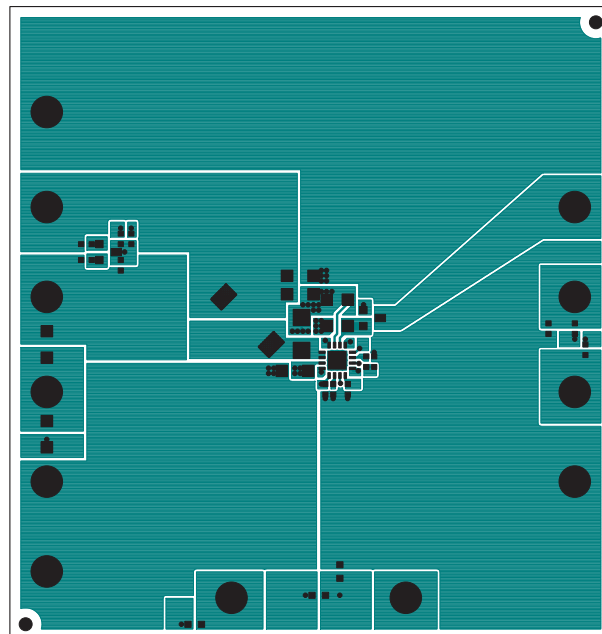

PCB LAYOUT AND FILM

Inner Layer 2

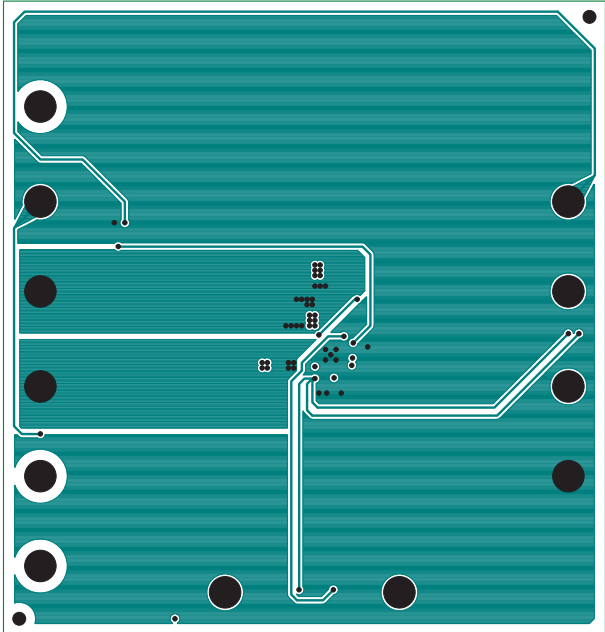

Inner Layer 3

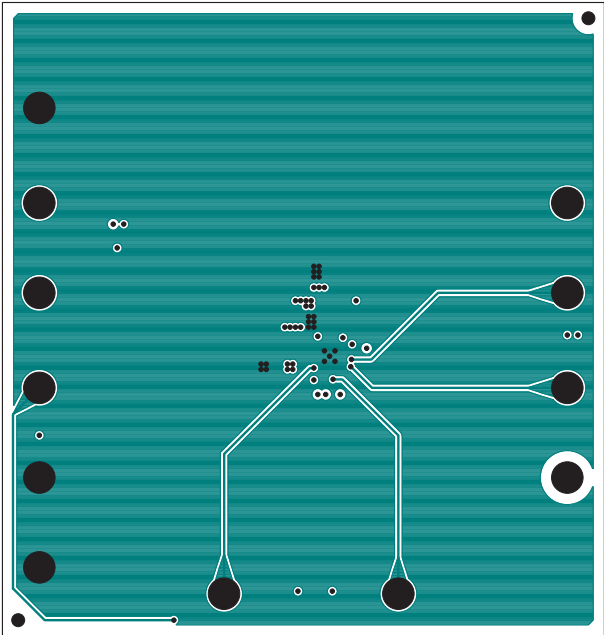

PCB LAYOUT AND FILM

Soldermask Top

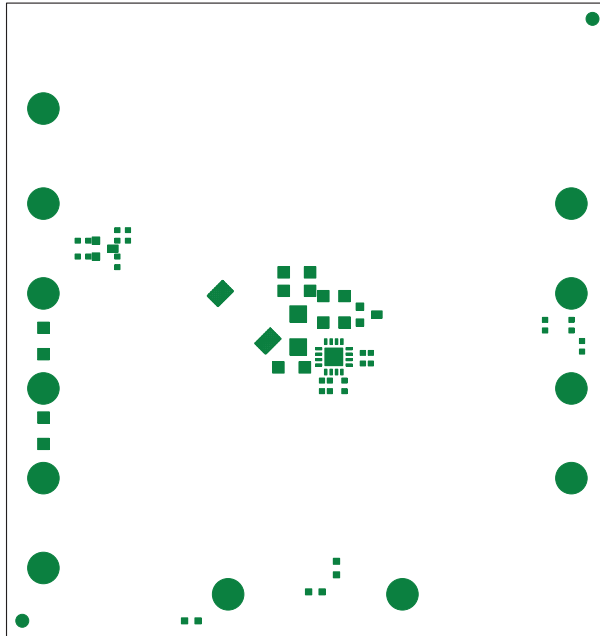

Pastemask Top

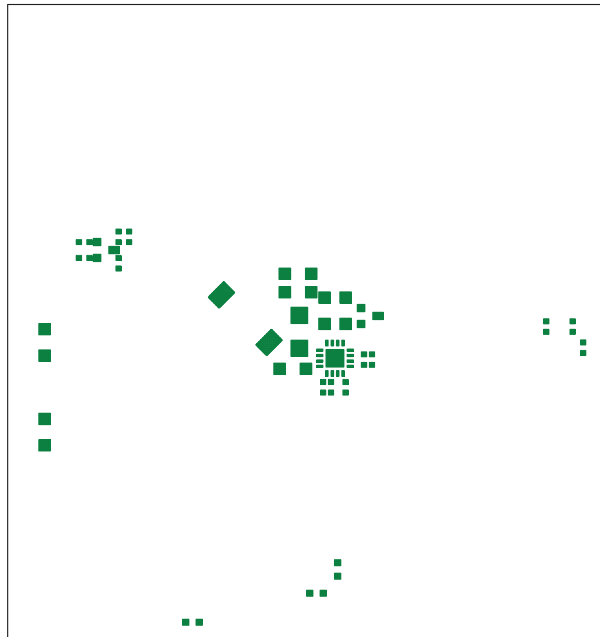

PCB LAYOUT AND FILM

Soldermask Bottom

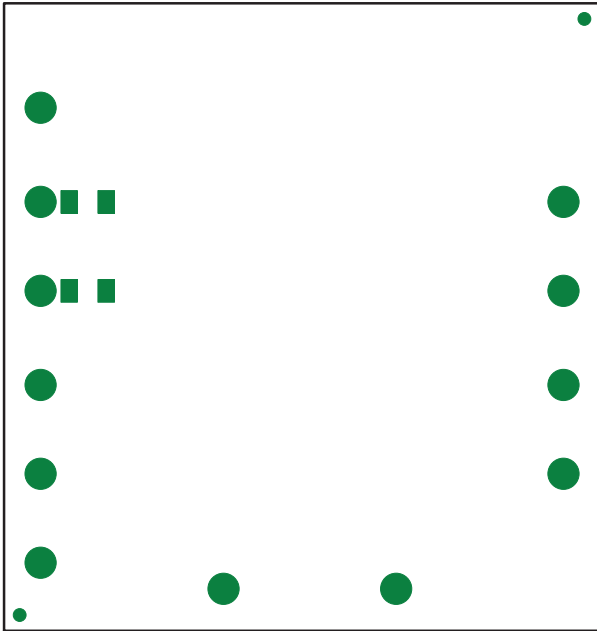

Pastemask Bottom

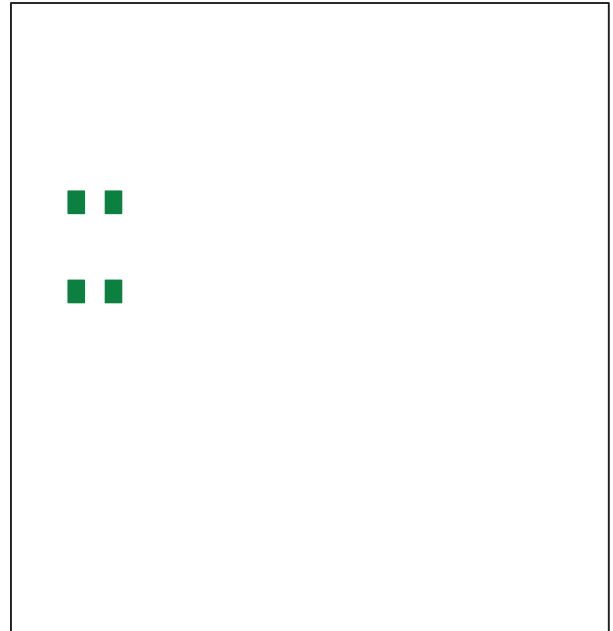

Solder Side

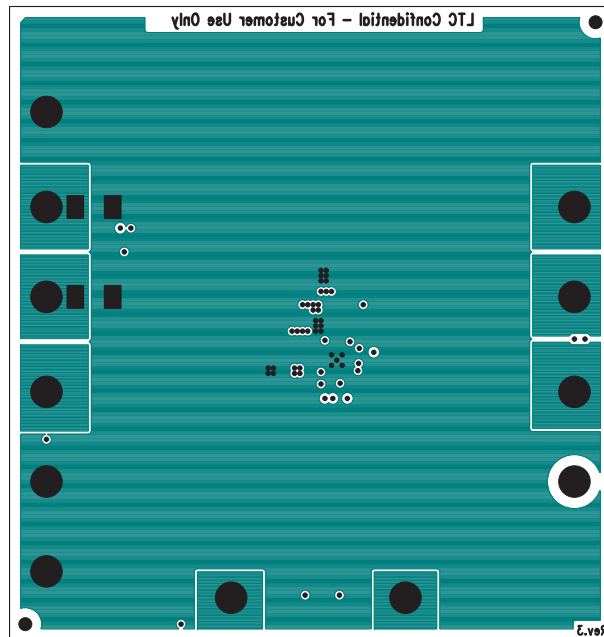

FABRICATION DRAWING

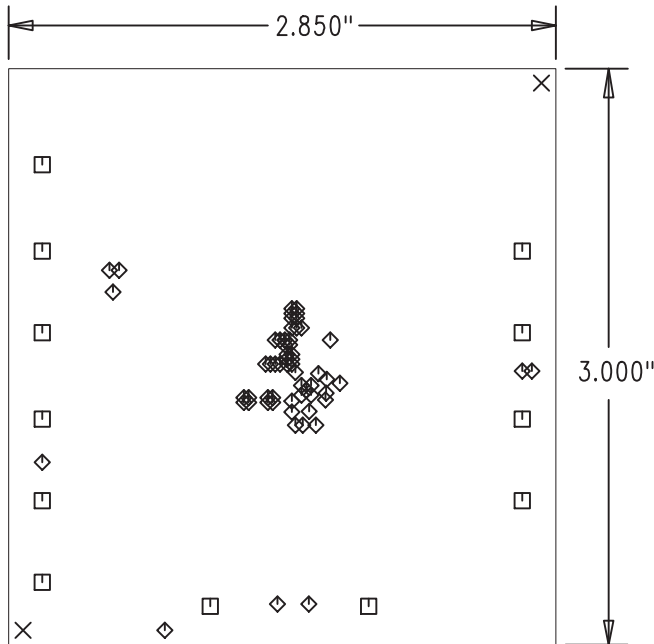

NOTES : Unless Otherwise Specified

1. FAB PER IPC-A-600
2. MATERIAL: EPOXY FIBERGLASS, NEMA GRADE FR-4
FINISHED THICKNESS TO BE 0.062" +/- 0.006"
TOTAL OF 4 LAYERS WITH 2 OZ. COPPER ON THE OUTER LAYERS AND 1 OZ. COPPER ON THE INTERNAL LAYERS.
FLAMMABILITY RATING: 94 V-0 MINIMUM .
3. FINISH: SMOBC USING LPI BOTH SIDES, COLOR GREEN.
WHITE TIN IMMERSION (OMIKRON). (not required for prototype)
FOR SILKSCREEN: USE WHITE NON-CONDUCTIVE INK.
4. DRILLING: DRILL HOLES PER SCHEDULE. ALL PLATED THROUGH HOLES WITH COPPER, 0.001" MIN. / 0.0015" MAX. COPPER PLATE ALL HOLE SIZES ARE SPECIFIED AFTER PLATING. HOLE LOCATION TOLERANCES ARE +/-0.003" IN RELATION TO CENTER
5. ALL DIMENSIONS ARE IN INCHES
6. SCORING FOR PANELIZED PCB: (not required for prototype)

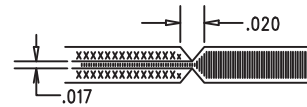

SIZE	QTY	SYM	PLTD
.072	2	X	NPLTD
.095	12	□	PLTD
.010	60	◇	PLTD

DEMO MANUAL DC1160

DEMONSTRATION BOARD IMPORTANT NOTICE

Linear Technology Corporation (LTC) provides the enclosed product(s) under the following **AS IS** conditions:

This demonstration board (DEMO BOARD) kit being sold or provided by Linear Technology is intended for use for **ENGINEERING DEVELOPMENT OR EVALUATION PURPOSES ONLY** and is not provided by LTC for commercial use. As such, the DEMO BOARD herein may not be complete in terms of required design-, marketing-, and/or manufacturing-related protective considerations, including but not limited to product safety measures typically found in finished commercial goods. As a prototype, this product does not fall within the scope of the European Union directive on electromagnetic compatibility and therefore may or may not meet the technical requirements of the directive, or other regulations.

If this evaluation kit does not meet the specifications recited in the DEMO BOARD manual the kit may be returned within 30 days from the date of delivery for a full refund. **THE FOREGOING WARRANTY IS THE EXCLUSIVE WARRANTY MADE BY THE SELLER TO BUYER AND IS IN LIEU OF ALL OTHER WARRANTIES, EXPRESSED, IMPLIED, OR STATUTORY, INCLUDING ANY WARRANTY OF MERCHANTABILITY OR FITNESS FOR ANY PARTICULAR PURPOSE. EXCEPT TO THE EXTENT OF THIS INDEMNITY, NEITHER PARTY SHALL BE LIABLE TO THE OTHER FOR ANY INDIRECT, SPECIAL, INCIDENTAL, OR CONSEQUENTIAL DAMAGES.**

The user assumes all responsibility and liability for proper and safe handling of the goods. Further, the user releases LTC from all claims arising from the handling or use of the goods. Due to the open construction of the product, it is the user's responsibility to take any and all appropriate precautions with regard to electrostatic discharge. Also be aware that the products herein may not be regulatory compliant or agency certified (FCC, UL, CE, etc.).

No License is granted under any patent right or other intellectual property whatsoever. **LTC assumes no liability for applications assistance, customer product design, software performance, or infringement of patents or any other intellectual property rights of any kind.**

LTC currently services a variety of customers for products around the world, and therefore this transaction **is not exclusive**.

Please read the DEMO BOARD manual prior to handling the product. Persons handling this product must have electronics training and observe good laboratory practice standards. **Common sense is encouraged.**

This notice contains important safety information about temperatures and voltages. For further safety concerns, please contact a LTC application engineer.

Mailing Address:

Linear Technology
1630 McCarthy Blvd.
Milpitas, CA 95035

Copyright © 2004, Linear Technology Corporation