

BK PRECISION®

Model: 2552, 2553, 2554, 2555, 2556,
2557, 2558, 2559

4CH/2CH Digital Storage Oscilloscopes

USER MANUAL

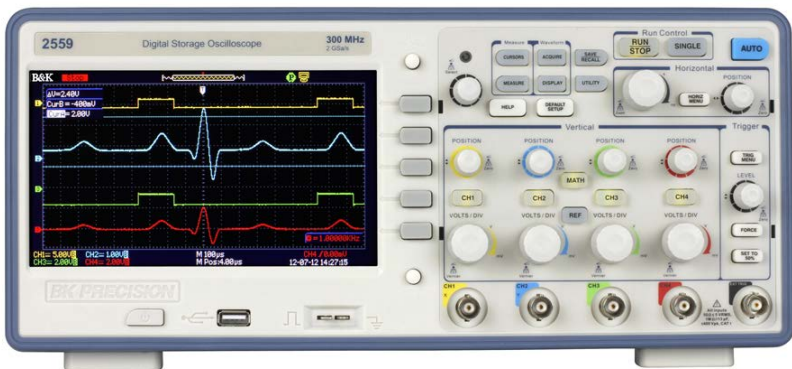

Safety Summary

The following safety precautions apply to both operating and maintenance personnel and must be observed during all phases of operation, service, and repair of this instrument. Before applying power, follow the installation instructions and become familiar with the operating instructions for this instrument.

If this device is damaged or something is missing, contact the place of purchase immediately.

This manual contains information and warnings must be followed to ensure safe operation as well as to maintain the oscilloscope in a safe condition.

GROUND THE INSTRUMENT

To minimize shock hazard, the instrument chassis and cabinet must be connected to an electrical ground. This instrument is grounded through the ground conductor of the supplied, three-conductor ac power cable. The power cable must be plugged into an approved three-conductor electrical outlet. Do not alter the ground connection. Without the protective ground connection, all accessible conductive parts (including control knobs) can render an electric shock. The power jack and mating plug of the power cable meet IEC safety standards.

DO NOT OPERATE IN AN EXPLOSIVE ATMOSPHERE

Do not operate the instrument in the presence of flammable gases or fumes. Operation of any electrical instrument in such an environment constitutes a definite safety hazard.

KEEP AWAY FROM LIVE CIRCUITS

Instrument covers must not be removed by operating personnel. Component replacement and internal adjustments must be made by qualified maintenance personnel. Disconnect the power cord before removing the instrument covers and replacing components. Under certain conditions, even with the power cable removed, dangerous voltages may exist. To avoid injuries, always disconnect power and discharge circuits before touching them.

DO NOT SERVICE OR ADJUST ALONE

Do not attempt any internal service or adjustment unless another person, capable of rendering first aid and resuscitation, is present.

DO NOT SUBSTITUTE PARTS OR MODIFY THE INSTRUMENT

Do not install substitute parts or perform any unauthorized modifications to this instrument. Return the instrument to B&K Precision for service and repair to ensure that safety features are maintained.

WARNINGS AND CAUTIONS

WARNING and **CAUTION** statements, such as the following examples, denote a hazard and appear throughout this manual. Follow all instructions contained in these statements.

A **WARNING** statement calls attention to an operating procedure, practice, or condition, which, if not followed correctly, could result in injury or death to personnel.

A **CAUTION** statement calls attention to an operating procedure, practice, or condition, which, if not followed correctly, could result in damage to or destruction of part or all of the product.

WARNING: *Do not alter the ground connection. Without the protective ground connection, all accessible conductive parts (including control knobs) can render an electric shock. The power jack and mating plug of the power cable meet IEC safety standards.*

WARNING: *To avoid electrical shock hazard, disconnect power cord before removing covers. Refer servicing to qualified personnel.*

CAUTION: *Before connecting the line cord to the AC mains, check the rear panel AC line voltage indicator. Applying a line voltage other than the indicated voltage can destroy the AC line fuses. For continued fire protection, replace fuses only with those of the specified voltage and current ratings.*

CAUTION: *This product uses components which can be damaged by electro-static discharge (ESD). To avoid damage, be sure to follow proper procedures for handling, storing and transporting parts and subassemblies which contain ESD-sensitive components.*

Compliance Statements

Disposal of Old Electrical & Electronic Equipment (Applicable in the European Union and other European countries with separate collection systems)

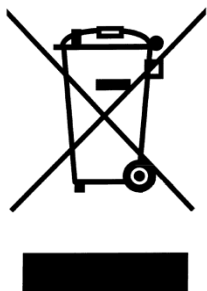

This product is subject to Directive 2002/96/EC of the European Parliament and the Council of the European Union on waste electrical and electronic equipment (WEEE) , and in jurisdictions adopting that Directive, is marked as being put on the market after August 13, 2005, and should not be disposed of as unsorted municipal waste. Please utilize your local WEEE collection facilities in the disposition of this product and otherwise observe all applicable requirements.

Safety Symbols



This symbol is used to denote the measurement ground connection.



This symbol on an instrument indicates caution. For details, the user should refer to the operating instructions in the manual.



Electrical Shock hazard.



This symbol shows that the switch is a power switch located at the top of the oscilloscope. Pressing this button toggles the oscilloscope's state between operation and power off mode.

**CAT I
(400V)**

IEC Measurement Category I.
Inputs may be connected to
mains (up to 400 VAC) under
Category I overvoltage conditions.

NOTES:

All references and functionality related to CH3 (channel 3) and CH4 (channel 4) in this manual are available on 4CH models 2553, 2555, 2557, and 2559. They are not available for 2CH models 2552, 2554, 2556 and 2558.

Table of Contents

SAFETY SUMMARY.....	3
CHAPTER 1 INTRODUCTION.....	10
PANEL AND DISPLAY INFORMATION	11
<i>Front Panel.....</i>	<i>11</i>
<i>Back Panel.....</i>	<i>12</i>
<i>Display Information</i>	<i>13</i>
PACKAGE CONTENTS.....	15
CHECKING FUNCTIONS	15
PROBE SAFETY	17
PROBE ATTENUATION	18
PROBE COMPENSATION.....	19
CHAPTER 2 FUNCTIONS AND OPERATING DESCRIPTIONS	20
MENU AND CONTROL BUTTON	21
CONNECTORS	23
AUTO SETUP.....	24
DEFAULT SETUP	26
UNIVERSAL KNOB	27
VERTICAL SYSTEM.....	28
CHANNEL FUNCTION MENU	29
<i>Setting Up Channels.....</i>	<i>32</i>
USING VERTICAL POSITION KNOB AND VOLTS/DIV KNOB	36
MATH FUNCTIONS.....	37
<i>FFT Function.....</i>	<i>38</i>
<i>Displaying the FFT Spectrum.....</i>	<i>40</i>
<i>Select FFT Window.....</i>	<i>41</i>
<i>Magnifying the FFT Spectrum.....</i>	<i>42</i>
<i>Measuring an FFT Spectrum Using Cursors</i>	<i>42</i>
USING REF.....	45
HORIZONTAL SYSTEM.....	47
<i>Horizontal Control Knob.....</i>	<i>47</i>
<i>Window Zone</i>	<i>48</i>
TRIGGER SYSTEM.....	49

<i>Signal Source</i>	50
<i>Trigger Type</i>	50
<i>Coupling</i>	68
<i>Position</i>	68
<i>Slope and Level</i>	68
<i>Trigger Holdoff</i>	69
SIGNAL ACQUISITION SYSTEM.....	70
DISPLAY SYSTEM.....	75
<i>X-Y Format</i>	79
MEASURE SYSTEM.....	80
<i>Scale Measurement</i>	80
<i>Cursor Measurement</i>	81
<i>Auto Measurement</i>	86
STORAGE SYSTEM.....	93
UTILITY SYSTEM.....	107
<i>System Status</i>	111
<i>Language</i>	111
<i>Self Calibration</i>	112
<i>Self Test</i>	113
<i>Updating Firmware</i>	116
<i>Pass/Fail</i>	117
<i>Waveform Recorder</i>	121
<i>Record</i>	126
HELP MENU.....	129
CHAPTER 3 REMOTE CONTROL.....	131
CHAPTER 4 APPLICATION EXAMPLES.....	132
TAKING SIMPLE MEASUREMENTS.....	133
MEASURING RING FREQUENCY.....	134
<i>Measuring Ring Amplitude</i>	135
CAPTURING A SINGLE EVENT.....	135
ANALYZING SIGNAL DETAILS.....	136
<i>Looking at a Noisy Signal</i>	136
<i>Separating the Signal from Noise</i>	137
TRIGGERING ON A VIDEO SIGNAL.....	137
<i>Triggering on Video Field</i>	137
<i>Triggering on Video Lines</i>	137

APPLICATION OF X-Y FUNCTION.....	138
ANALYZING A DIFFERENTIAL COMMUNICATION SIGNAL	139
CHAPTER 5 MESSAGE PROMPTS AND TROUBLESHOOTING.....	141
MESSAGE PROMPTS	141
TROUBLESHOOTING	142
CHAPTER 6 SPECIFICATIONS	144
SPECIFICATIONS.....	144
CERTIFICATION.....	151
APPENDIX A DEFAULT SETUP.....	152
APPENDIX B INDEX	155
APPENDIX C DISABLING AUTO FUNCTION.....	156
SERVICE INFORMATION	157
LIMITED THREE-YEAR WARRANTY	158

Chapter 1 Introduction

The 2550 series digital storage oscilloscopes (DSO) are portable benchtop instruments used for making measurements of signals and waveforms. This chapter will highlight information on the following:

- Panel and display information
- Package Contents
- Checking functions
- Probe Attenuation
- Probe Compensation

Panel and Display Information

Front Panel

The following contents are a brief introduction for the front panel function, which is useful to become familiar with the operation of the DSO.

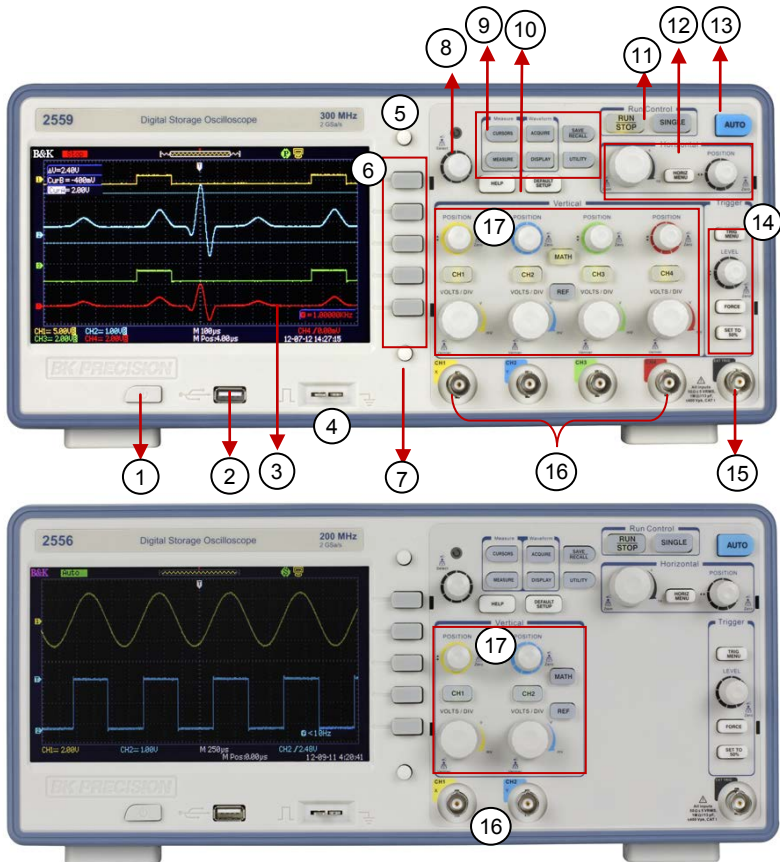
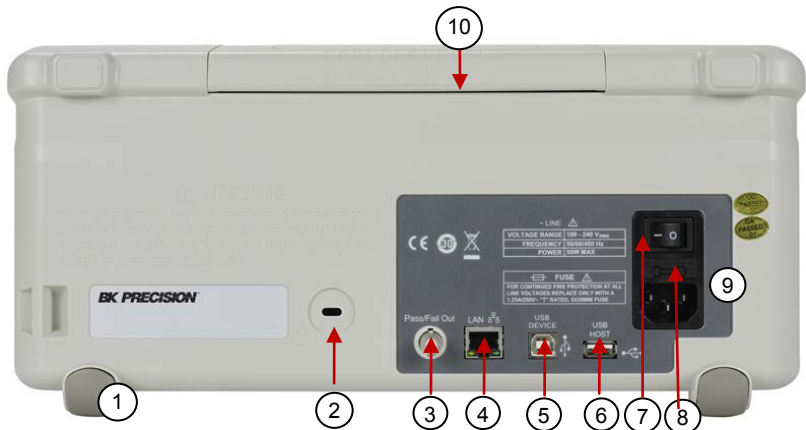

Figure 1 - 4 channel (top) and 2 channel (bottom) front panels

1. Power On/Off button
2. USB Host port (for storage to USB flash drives)
3. LCD display
4. 1 kHz probe compensation terminal
5. Menu On/Off button
6. Function keys
7. Print button
8. Universal knob
9. Cursor, Measure, Acquire, Display, Save/Recall, Utility menu buttons
10. Help and default setup button
11. Run Controls (Single, Run/Stop)
12. Horizontal Controls (Time/div, horizontal position, Horizontal menu)
13. Auto set button
14. Trigger Controls (Trigger menu, Set to 50%, Force, Trigger level)
15. External trigger BNC
16. 2CH/4CH BNC inputs
17. Vertical Controls (Volts/div, vertical position, CH1 & CH2 or CH1, CH2, CH3, CH4, On/Off, Math function, Reference function)

Back Panel

The following shows the back panel connections of the DSO.



1. Rubber feet
2. Kensington security slot
3. Pass/Fail BNC output
4. LAN interface
5. USB device port (for remote communication)
6. Rear USB host port (for storage to USB flash drives)
7. Main AC power switch
8. Input fuse holder
9. AC line input
10. Carrying handle

Display Information

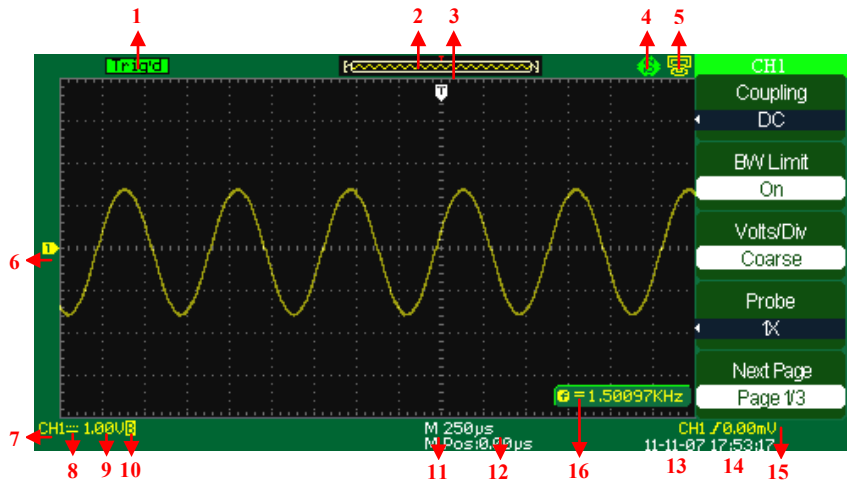





Figure 5 - Display Screen

1. Trigger status
 - **Armed** - The oscilloscope is acquiring pre-trigger data. All triggers are ignored in this state.
 - **Ready** - All pre-trigger data has been acquired and the oscilloscope is ready to accept a trigger.

- **Trig'd** - The oscilloscope has seen a trigger and is acquiring the post-trigger data.
 - **Stop** - The oscilloscope has stopped acquiring waveform data.
 - **Auto** - The oscilloscope is in auto mode and is acquiring waveforms in the absence of triggers.
 - **Scan** - The oscilloscope is acquiring and displaying waveform data continuously in scan mode. This mode occurs when oscilloscope is looking for a signal or when timebase is set slow enough in which the scope requires longer time to “scan” in order to acquire the entire signal on display.
2. Displays position of the present waveform window in internal memory.
 3. Marker shows horizontal trigger position. Turn the **HORIZONTAL POSITION KNOB** to adjust the position of the marker.
 4. Print Key – Indicates whether the **PRINT KEY** option is set to print picture or save picture.
 -  “Print Key” option is set to “Save Picture”
 5. Back USB – Indicates whether the **BACK USB** option is set to Computer/USBTMC or Printer.
 -  “Back USB” option is set to “Computer”.
 -  “Back USB” option is set to “Printer” (not available)
 6. Waveform channel number tag.
 7. On-screen markers show the ground reference points of the displayed waveforms. If there is no marker, the channel is not displayed. Display signal source.
 8. Signal Coupling Symbol
 9. Vertical scale factor of corresponding channels.
 10. Indicates whether the bandwidth limiting filter is “On” or “Off”. The “B” icon indicates the filter is On.
 11. Main time base scale setting
 12. Horizontal position of main time base waveform.

13. Shows the icon for the trigger type
14. Displays real time and date
15. Shows the trigger voltage
16. Trigger signal frequency

Package Contents

The digital storage oscilloscopes are shipped with the following contents:

- 2550 series Digital Storage Oscilloscope
- User Manual
- USB (Type A to B) communication cable
- AC Power Cord
- Four 10:1 passive oscilloscope probes for 4 channel models, two probes for 2 channel models
- Certificate of Calibration

Please locate each item from the original packaging and contact B&K Precision immediately if something is missing.

Checking Functions

Please follow the steps below when checking the oscilloscope's functionality.

1. Power on the oscilloscope.

Press "DEFAULT SETUP" to set to factory default settings. The probe default attenuation is 1X.

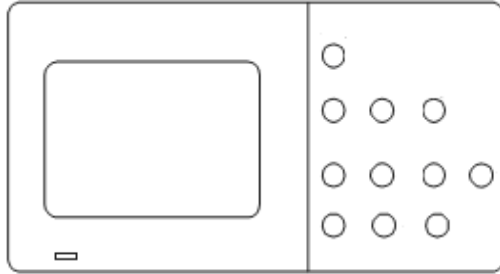

Figure 6 - Scope Layout

2. Set the switch to 1X on the probe and connect the probe to channel 1 on the oscilloscope. To do this, align the slot in the probe connector with the key on the CH 1 BNC, push to connect, and twist to the right to lock the probe in place. Connect the probe tip and reference lead to the PROBE COMP connectors.

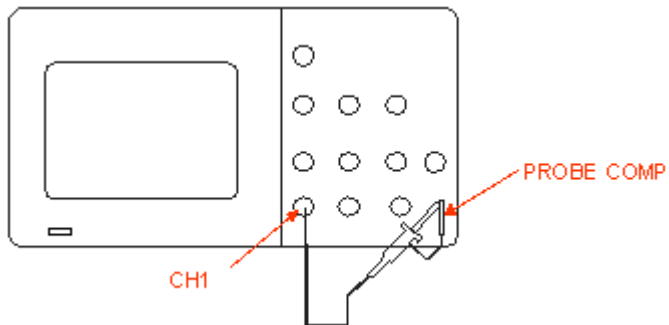

Figure 7 - Probe Compensation

3. Press "AUTO" to show the 1 kHz frequency and about 3V peak-peak square wave in couple seconds.

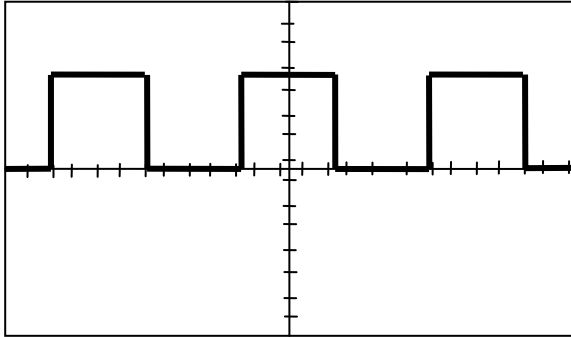

Figure 8 - 3Vpp Square Wave

4. Press “CH1” two times to cancel the channel 1, Press “CH2” to change screen into channel 2, reset the channel 2 as step 2 and step 3. Do the same for 4CH models by pressing “CH3” and “CH4” for channel 3 and channel 4 respectively.

Probe Safety

A guard around the probe body provides a finger barrier for protection from electric shock.

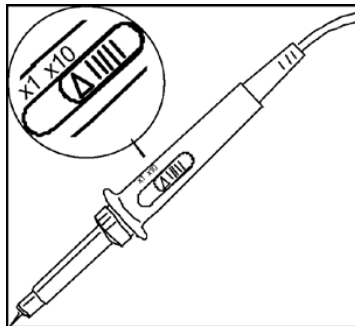

Figure 9 - Probe

Connect the probe to the oscilloscope and connect the ground terminal to ground before you take any measurements.

Note: To avoid electric shock when using the probe, keep fingers behind the guard on the probe body.

To avoid electric shock while using the probe, do not touch metallic portions of the probe head while it is connected to a voltage source.

Connect the probe to the oscilloscope and connect the ground terminal to ground before you take any measurements.

Probe Attenuation

Probes are available with various attenuation factors which affect the vertical scale of the signal. The Probe Check function verifies that the Probe attenuation option matches the attenuation of the probe.

You can push a vertical menu button (such as the CH 1 MENU button), and select the Probe option that matches the attenuation factor of your probe.

Note. The default setting for the Probe option is 1X.

Be sure that the attenuation switch on the probe matches the Probe option in the oscilloscope. Switch settings are 1X and 10X.

Note. When the attenuation switch is set to 1X, the probe limits the bandwidth of the oscilloscope to 10 MHz (according to Probe spec). To use the full bandwidth of the oscilloscope, be sure to set the switch to 10X.

Probe Compensation

As an alternative method to Probe Check, you can manually perform this adjustment to match your probe to the input channel.

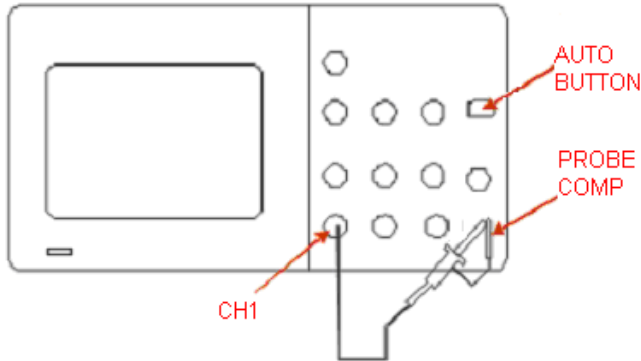
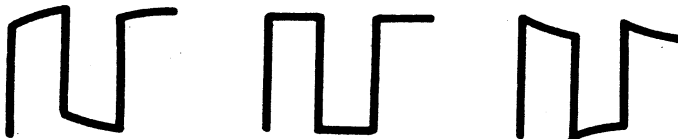

Figure 10 - Probe Compensation Setup

1. Set the Probe option attenuation in the channel menu to 10X. Do so by pressing CH1 button and selecting “Probe” from menu. Select 10X. Set the switch to 10X on the probe and connect the probe to channel 1 on the oscilloscope. If you use the probe hook-tip, ensure a proper connection by firmly inserting the tip onto the probe.
2. Attach the probe tip to the PROBE COMP 3V connector and the reference lead to the PROBE COMP Ground connector. Display the channel and then push the “AUTO” button.
3. Check the shape of the displayed waveform.



Overcompensated	Compensated Correctly	Undercompensated
-----------------	-----------------------	------------------

4. If necessary, adjust your probes compensation trimmer pot. Repeat as necessary.

Chapter 2 Functions and Operating Descriptions

This chapter will cover all the functions and operations of the oscilloscope:

- Menu and control button
- Connector
- Auto Setup
- Default Setup
- Universal knob
- Vertical System
- Horizontal System
- Trigger System
- Acquiring signals System
- Display System
- Measuring waveforms System
- Utility System
- Storage System
- Online Help function

Menu and Control Button



Figure 11 - Control Buttons (4CH model shown)

Channel buttons (CH1, CH2, CH3, CH4): Press a channel button (CH1, CH2, CH3, or CH4) to turn that channel ON or OFF and open the Channel menu for that channel. You can use the channel menu to set up a channel. When the channel is ON, the channel button is lit.

MATH: Press to display the Math menu. You can use the MATH menu to use the oscilloscope's Math functions.

REF: Press to display the Ref Wave menu. You can use this menu to save and recall reference waveforms to and from internal memory.

HORI MENU: Press to display the Horizontal menu. You can use the Horizontal menu to display the waveform and to zoom a segment of a waveform.

TRIG MENU: Press to display the Trigger menu. You can use the Trigger menu to set the trigger type (Edge, Pulse, Video, Slope, Alternate and trigger settings).

SET TO 50%: Press to stabilize a waveform quickly. The oscilloscope can set the trigger level to be halfway between the minimum and maximum voltage level automatically. This is useful when you connect a signal to the EXT TRIG connector and set the trigger source to Ext or Ext/5.

FORCE: Use the FORCE button to complete the current waveform acquisition whether the oscilloscope detects a trigger or not. This is useful for Single acquisitions and Normal trigger mode.

SAVE/RECALL: Press to display the Save/Recall menu. You can use the Save/Recall menu to save and recall up to 20 oscilloscope setups and 20 waveforms to/from internal memory or a USB memory device (limited by memory capacity of USB device). You can also use it to recall the default factory settings, to save waveform data as a comma-delimited file (.CSV), and to save the displayed waveform image.

ACQUIRE: Press to display Acquire menu. You can use the Acquire menu to set the acquisition Sampling Mode (Sampling, Peak Detect, Average).

MEASURE: Press to display a menu of measurement parameters.

CURSORS: Display the Cursor Menu. Vertical Position controls adjust cursor position while displaying the Cursor Menu and the cursors are activated. Cursors remain displayed (unless the “Type” option is set to “Off”) after leaving the Cursor Menu but are not adjustable.

DISPLAY: Press to open the Display menu. You can use the Display menu to set grid and waveform display styles, and persistence.

UTILITY: Press to open the Utility menu. You can use the Utility menu to configure oscilloscope features, such as sound, language, counter, etc. You can also view system status and update software.

DEFAULT SETUP: Press to reset the oscilloscope's settings to the default factory configuration.

HELP: Enter the online help system.

AUTO: Automatically sets the oscilloscope controls to produce a usable display of the input signals.

RUN/STOP: Continuously acquires waveforms or stops the acquisition.

Note: If waveform acquisition is stopped (using the RUN/STOP or SINGLE button), the TIME/DIV control expands or compresses the waveform.

SINGLE: Acquire a single waveform and then stops.

Connectors



Figure 12 - Connectors

Channel Connector (CH1, CH2, CH3, CH4): Input connectors for waveform display.

EXT TRIG: Input connector for an external trigger source. Use the Trigger Menu to select the “Ext” or “Ext/5” trigger source.

Probe Compensation: 1 kHz voltage probe compensation output and ground. Use to electrically match the probe to the oscilloscope input circuit.

Note: Do not connect a voltage source to the ground terminal or it may damage the oscilloscope.

Auto Setup

The 2550 series Digital Storage Oscilloscopes have an Auto Setup function that identifies the waveform types and automatically adjusts controls to produce a usable display of the input signal.

Press the AUTO front panel button, and then press the menu option button adjacent to the desired waveform as follows:

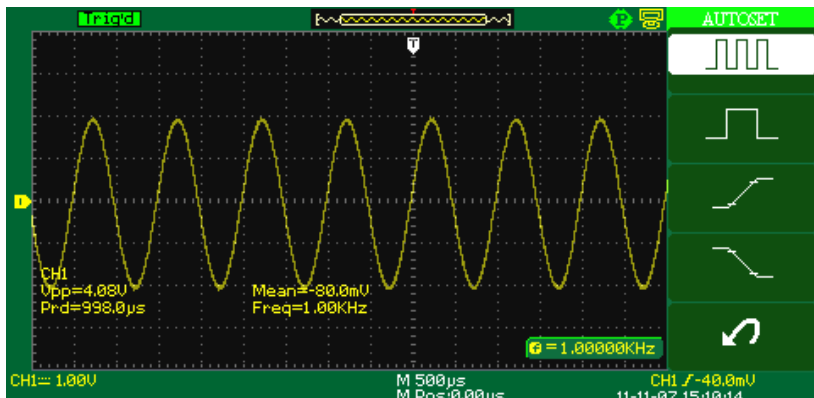

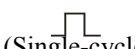
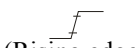
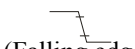



Figure 13 - Auto Setup

Note: For AUTO set to function properly, the signal frequency must be > 5 Hz. There will be a short time delay when using AUTO to setup 4 channels.

Table 1 - Autoset Menu

Option	Description
 (Multi-cycle sine)	Auto set the screen and display multi-cycle signal.
 (Single-cycle sine)	Set the screen and auto display single cycle signal.
 (Rising edge)	Auto set and show the rising time.
 (Falling edge)	Auto set and show the falling time.
 (Undo Setup)	Causes the oscilloscope to recall the previous setup.

Auto set determines the trigger source based on the following conditions:

- If multiple channels have signals, the channel with the lowest frequency signal.
- No signals found, the lowest-numbered channel displayed when Auto set was invoked
- No signals found and no channels displayed, oscilloscope displays and uses channel 1.

Table 2 - Autoset Function Menu Items

Function	Setting
Acquire Mode	Adjusted to Sampling
Display Format	Y-T
Display Type	Set to Dots for a video signal, set to Vectors for an FFT spectrum; otherwise, unchanged
Vertical Coupling	Adjusted to DC or AC according to the input signal
Bandwidth Limit	Off(full)
V/div	Adjusted

VOLTS/DIV adjustability	Coarse
Signal inverted	Off
Horizontal position	Center
TIME/DIV	Adjusted
Trigger type	Edge
Trigger source	Auto detect the channel which has the input signal
Trigger slope	Rising
Trigger mode	Auto
Trigger coupling	DC
Trigger holdoff	Minimum
Trigger level	Set to 50%

Note: The AUTO button can be disabled. Please see “Appendix C Disabling Auto Function” for details.

Default Setup

The oscilloscope is set up for normal operation when it is shipped from the factory. This is the default setup. To recall this setup, press the **DEFAULT SETUP** button. For the default options, buttons, and controls, when you press the **DEFAULT SETUP** button, refer to “Appendix A Default Setup”.

The **DEFAULT SETUP** button does not reset the following settings:

- Language option
- Saved reference waveform files
- Saved setup files
- Display contrast
- Calibration data

Universal Knob



Figure 14 - Universal Knob

You can use the Universal knob with many functions, such as adjusting the hold off time, moving cursors, setting the pulse width, setting the video line, adjusting the upper and lower frequency limit and adjusting X and Y masks when using the pass/fail function. You can also turn the Universal knob to adjust the storage position of setups, waveforms, pictures when saving/recalling, and to select menu options. With some functions, the light indicator above the knob will turn on to indicate that the knob can be used to make changes or adjustments for that function. The knob can also be pushed to make a selection after changes/adjustments have been made.

Vertical System

The vertical control could be used for displaying waveform, rectify scale and position.



Figure 15 - Vertical System Controls

Channel Function Menu

Table 3 - Channel Function Menu

Option	Setting	Description
Coupling	DC	DC passes both AC and DC components of the input signal.
	AC	AC blocks the DC component of the input signal and attenuates signals below 10 Hz.
	GND	GND disconnects the input signal.
BW Limit	Off	Disables bandwidth limit.
	On	Enables bandwidth limit.
Volts/Div	Coarse	Selects the resolution of the Volts/Div knob Coarse defines a 1-2-5 sequence. Fine changes the resolution to small steps between the coarse settings.
	Fine	
Probe	1X 10X 100X 1000X	Set to match the type of probe you are using to ensure correct vertical readouts.
Next Page	Page 1/3	Press this button to enter second page menu.

Table 4 - Channel Function Menu 2

Option	Setting	Description
Invert	On	Turn on invert function.
	Off	Turn off invert function.
Input	1M	Set input impedance to 1M Ω .
	50 Ω	Set input impedance to 50 Ω

Filter		Press this button to enter the “Digital Filter menu”.
Next Page	Page 2/3	Press this button to enter the third page menu.

Table 5 - Channel Function Menu 3

Option	Setting	Description
Unit	V	Set the scale unit to voltage.
	A	Set the scale unit to current.
Skew	0 – 100 ns	Set the skew time between two channels.
Next Page	Page 3/3	Press this button to return the first page menu.

Table 6 - Digital Function Menu

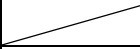
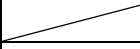
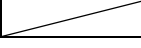
Option	Setting	Description
Filter	On Off	Turn on the digital filter. Turn off the digital filter.
Type		Setup as LPF (Low Pass Filter). Setup as HPF (High Pass Filter). Setup as BPF (Band Pass Filter). Setup as BRF (Band Reject Filter).
Upp_limit		Turn the “Universal” knob to set upper limit.
Low_limit		Turn the “Universal” knob to set lower limit.
Return		Return to digital filter main menu.

- **“GND” Coupling:** Use GND coupling to display a zero-volt waveform. Internally, the channel input is connected to a zero-volt reference level.
- **Fine Resolution:** The vertical scale readout displays the actual Volts/Div setting while in the fine resolution setting. Changing the setting to coarse does not change the vertical scale until the VOLTS/DIV control is adjusted.

Note:

- The oscilloscope’s vertical response rolls off slowly above its specified bandwidth. Therefore, the FFT spectrum can show valid frequency information higher than the oscilloscope’s bandwidth. However, the magnitude information near or above the bandwidth will not be accurate.
- If the channel is set to DC coupling, you can quickly measure the DC component of the signal by simply noting its distance from the ground symbol.
- If the channel is set to AC coupling, the DC component of the signal is blocked allowing you to use greater sensitivity to display the AC component of the signal.

Setting Up Channels

Each channel has its own separate Menu. The items are set up separately according to each channel.

1. Setup Channel Coupling

Take CH1 for example; the tested signal is a sine wave signal with DC deflection:

- Press“CH1”→“Coupling”→“AC”, Set to AC couple mode. This will block the DC component of the input signal.
- Press“CH1”→“Coupling”→“DC”, Set to DC couple mode. Both DC and AC components of the input signal will be captured.
- Press“CH1”→“Coupling”→“GND”, Set to GROUND mode. This disconnects the input signal.

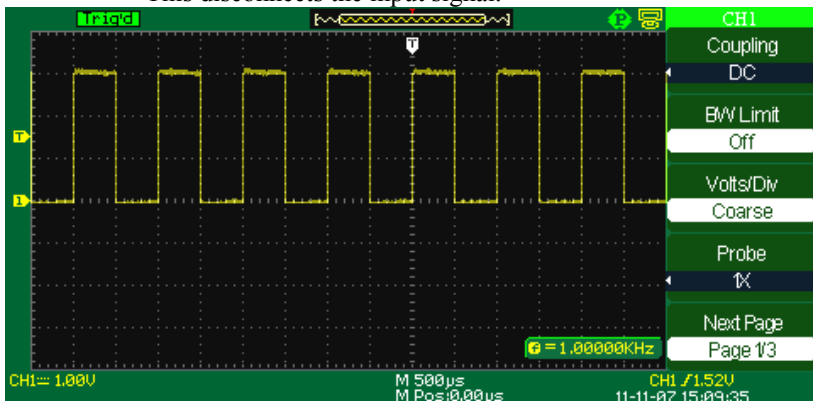

Figure 16 - DC Coupling

2. Bandwidth Limiting

Take CH1 for example:

- Press “CH1”→“BW Limit”→ “On”, and bandwidth will be limited to 20 MHz.
- Press“CH1”→“BW Limit”→ “Off”, and bandwidth limit will be disabled.

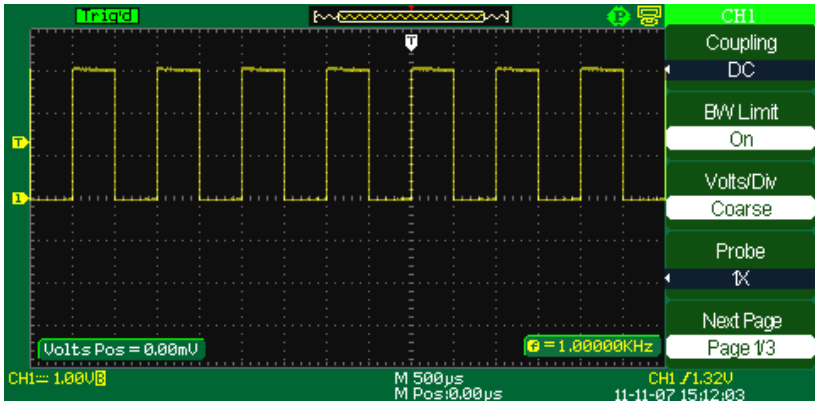

Figure 17 - Bandwidth Limit

3. Volts/Div Settings

Vertical scale adjust have Coarse and Fine modes, Vertical sensitivity range of 2 mV/div – 10 V/div.

Take CH1 for example:

- Press “CH1” → “Volts/Div” → “Coarse”. It is the default setting of Volts/Div, and it makes the vertical scaling in a 1-2-5-step sequence from 2 mV/div, 5 mV/div, 10 mV/div to 10 V/div.

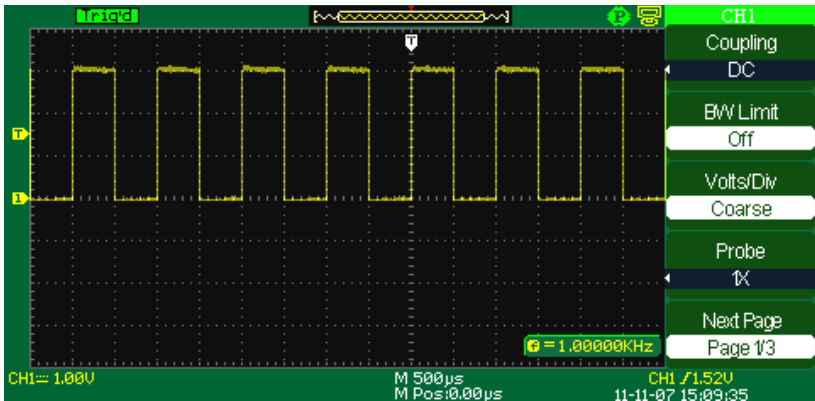

Figure 18 - Coarse Control

- Press CH1 → Volts/Div → Fine”. This setting changes the vertical control to small steps between the coarse settings. It will be helpful when you need to adjust the waveform vertical size in smaller steps.

4. Setting Probe Attenuation

In order to set the attenuation coefficient, you need to specify it in the channel operation Menu. If the attenuation coefficient is 10:1, the input coefficient should be set to 10X, so that the Volts/div information and measurement testing is correct.

Take CH1 for example, when you use the 100:1 probe:

- Press “CH1” → “Probe” → “100X”

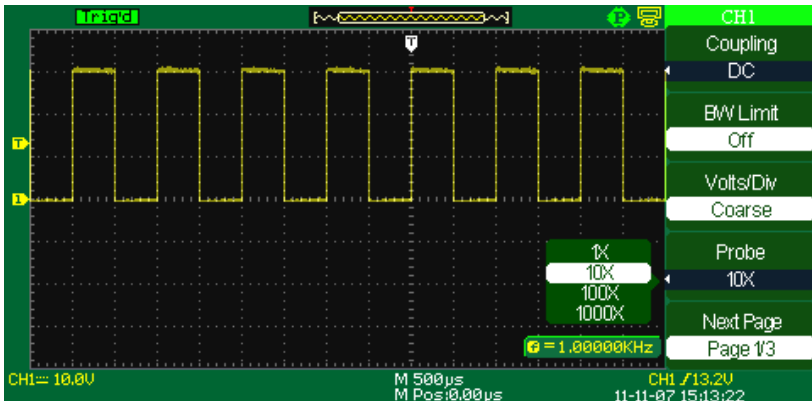

Figure 19 - Setting Probe Attenuation

5. Inverting waveforms

Take CH1 for example:

- Press “CH1” → “Next Page page 1/2” → “Invert” → “On”:

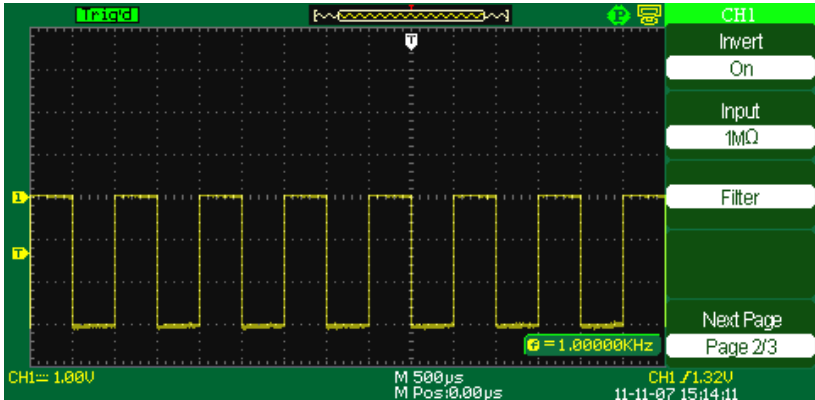

Figure 20- Invert Waveform Screen

6. Using the Digital Filter

Press “CH1”→“Next Page page 1/2”→ “Filter”, display the digital filter menu. Select “Filter Type”, then select “Upper Limit” or “Lower Limit” and turn the “Universal” knob to adjust them.

- Press “CH1”→“Next Page page 1/2”→ “Filter” →“Off”. Turn off the Digital Filter function.

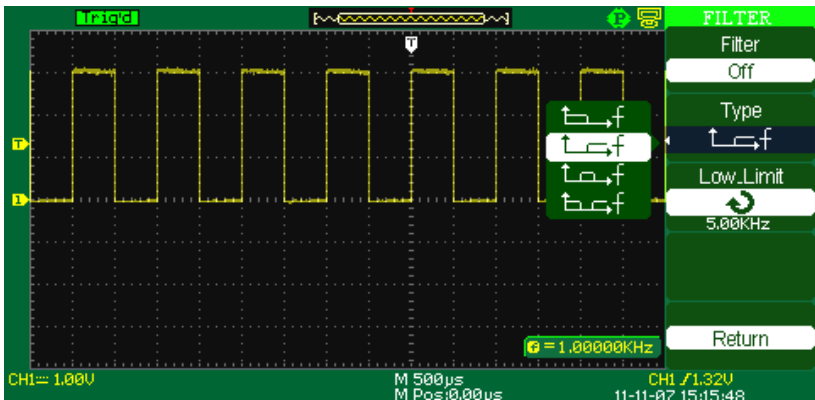

Figure 21 - Digital Filter Menu

- Press “CH1”→ “Next Page page1/2”→ “Filter” → “On”. Turn on the Digital Filter function.

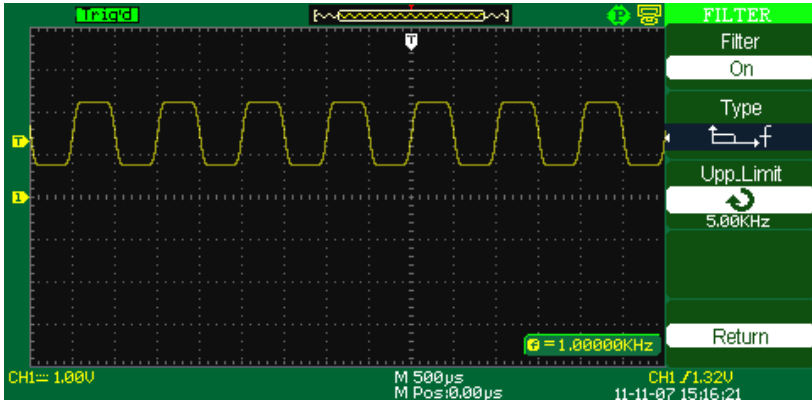

Figure 22 - Digital Filter Adjustment Screen

Using Vertical Position Knob and Volts/div Knob

- **Vertical “POSITION” knob**
 1. Use the Vertical “POSITION” knobs to move the channel waveforms up or down on the screen. This button’s resolution varies based on the vertical scale.
 2. When you adjust the vertical position of channel waveforms, the vertical position information will display on the bottom left of the screen. For example “Volts Pos=24.6mV”.
 3. Press the vertical “POSITION” knob to set the vertical position to zero.
- **“Volts/div” knob**
 1. Use the “Volts/div” knobs to control how the oscilloscope amplifies or attenuates the source signal of channel waveforms. When you turn the “volts/div” knob, the oscilloscope increases or decreases the vertical size of the waveform on the screen with respect to the ground level;
 2. When you press the “Volts/div” Knob, you can switch “Volts/div” option between “Coarse” and “Fine”. The vertical scale is set by the 1-2-5 step in Coarse mode. Increase by turning the knob in the clockwise direction and

decrease by turning the knob in the counterclockwise direction. In Fine mode, the knob changes the Volts/Div scale in small steps between the coarse settings. Again, increase in the clockwise direction, decrease in the counterclockwise direction.

Math Functions

Math shows the results after +, -, *, /, and FFT operation between two channels, from CH1 to CH4 (CH3 and CH4 available for 4CH models only). Press the MATH button to display the math waveform and menu. Press the MATH button again to remove the math waveform display.

Table 7 - Math Function Menu

Function	Setting	Description
Operation	+, -, *, /, FFT	Math operations between Source A and Source B.
Source A	CH1 – CH4	Select CH1, CH2, CH3*, or CH4* as Source A.
Source B	CH1 – CH4	Select CH1, CH2, CH3*, or CH4* as Source B.
Invert	On Off	Invert the Math waveform. Turn off Invert function.
Next Page	Page 1/2	Enter the second page of MATH menu.

*4CH models only



Function	Setting	Description
		Use universal knob to adjust the vertical position of the MATH waveform.
		Use universal knob to adjust the vertical scale of the MATH waveform.
Next Page	Page 2/2	Go back to first page of MATH menu.

Table 8 - Math Function Description

Operation	Setting	Description
+	A+B	Source A waveform adds Source B waveform.
-	A-B	Source A waveform is subtracted from Source B waveform.
*	A*B	Source A multiply Source B
/	A/B	Source A divides Source B
FFT	Fast Fourier Transform.	

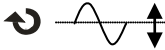
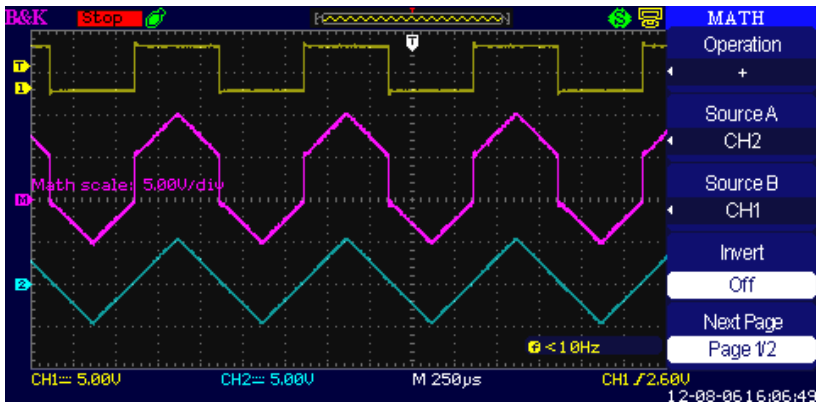

Figure 23- Math Waveform

FFT Function

The FFT process mathematically converts a time-domain signal into its frequency components. You can use the Math FFT mode to view the following types of signals:

- Analyze the harmonic wave in a power cable.
- Test the harmonic content and distortion in a system

- Show the Noise in a DC power supply
- Test the filter and pulse response in a system
- Analyze vibration

Table 9 - FFT Function Menu 1

FFT Option	Setting	Description
Source	CH1, CH2, CH3*, CH4*	Select this channel as the FFT source.
Window	Hanning Hamming Rectangular Blackman	Select FFT window types.
FFT ZOOM	1X 2X 5X 10X	Changes the horizontal magnification of the FFT display.
Next Page	Page 1/2	Enter the second page of FFT menu.

*4CH models only

Table 10 - FFT Function Menu 2

FFT Option	Setting	Description
Scale	Vrms	Set Vrms to be the Vertical Scale unit.
	dBVrms	Set dBVrms to be the vertical Scale unit.
Display	Split Full screen	Display FFT waveform on half screen. Display FFT waveform on full screen.
Next Page	Page 2/2	Return to the first page of FFT menu.

To use the Math FFT mode, you need to perform the following tasks:

1. Set up the source (time-domain) waveform.
2. Press the AUTO button to display a YT waveform.
3. Turn the vertical “POSITION” knob to move the YT waveform to the center vertically (zero divisions).
4. Turn the horizontal “POSITION” knob to position the part of the YT waveform that you want to analyze in the center eight divisions of the screen.

5. The oscilloscope calculates the FFT spectrum using the center 1024 points of the time-domain waveform.
6. Turn the “Volts/div” knob to ensure that the entire waveform remains on the screen.
7. Turn the “Time/div” knob to provide the resolution you want in the FFT spectrum.
8. If possible, set the oscilloscope to display many signal cycles.

To display FFT correctly, follow these steps:

1. Push the “MATH” button.
2. Set the “Operation” option to FFT.
3. Press the “Source” button to select “CH1”, “CH2”, “CH3”, or “CH4” according to input signal channel. (CH3 and CH4 available for 4CH models only)
4. According to Nyquist law, turn the “Time/div” knob to adjust the sampling rate (this parameter is displayed behind the time base parameter), making sure it is at least double the input signal frequency.

Displaying the FFT Spectrum

Press the MATH button to display the Math Menu. Use the options to select the Source channel, Window algorithm, and FFT Zoom factor. You can display only one FFT spectrum at a time. You can select “Full screen” or “Split” in “Display” option to display FFT waveform on full screen or display channel waveform and its FFT waveform on half screen at a time.

Figure 24 - Math Function Screen

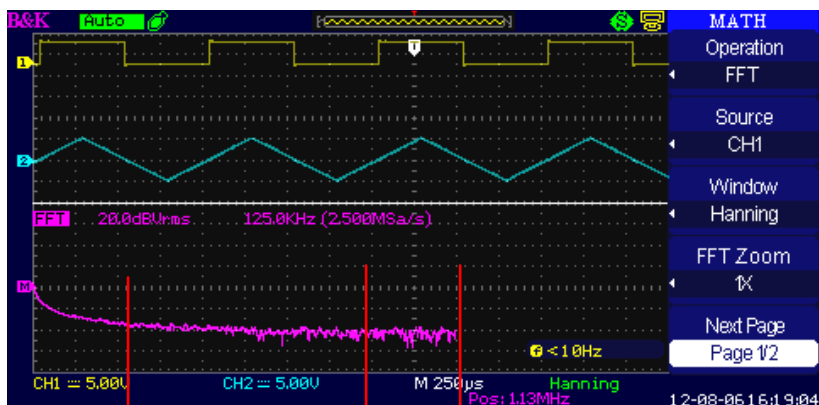

Set dBVrms to be the vertical Scale unit

Time base scale

Sampling rate

Select FFT Window

Windows reduce spectral leakage in the FFT spectrum. The FFT assumes that the YT waveform repeats forever. With an integral number of cycles, there are no discontinuities in the signal shape. A non-integral number of cycles in the YT waveform cause the signal start and end points to be at different amplitudes. The transitions between the start and end points cause discontinuities in the signal that introduce high-frequency transients.

Table 11 - FFT Window Instruction

Window	Characteristics	Applications
Rectangular	Best frequency resolution, worst magnitude resolution. This is essentially the same as no window.	Symmetric transients or bursts. Equal-amplitude sine waves with fixed frequencies. Broadband random noise with a relatively slowly varying

		spectrum.
Hanning Hamming	Better frequency, poorer magnitude accuracy than Rectangular. Hamming has slightly better frequency resolution than Hanning.	Sine, periodic, and narrow-band random noise. Asymmetric transients or bursts.
Blackman	Best magnitude, worst frequency resolution.	Single frequency waveforms, to find higher order harmonics.

Magnifying the FFT Spectrum

You can magnify and use cursors to take measurements on the FFT spectrum. The oscilloscope includes an “FFT Zoom” option to magnify horizontally, press this option button to select “1X”, “2X”, “5X” or “10X”. Moreover, you also can turn the “Universal” knob to magnify FFT waveform horizontally in a 1-2-5 step. To magnify vertically, turn the “Volts/div” knob.

Measuring an FFT Spectrum Using Cursors

You can take two measurements on FFT spectrums: magnitude (in dB) and frequency (in Hz). Magnitude is referenced to 0 dB, where 0 dB equals 1 V_{rms}. You can use the cursors to take measurements at any zoom factor. Use horizontal cursors to measure amplitude and vertical cursors to measure frequency.

If you input a sine signal to channel 1, follow these steps:

1. Measure FFT Amplitude

1. Input a sine signal to channel 1, and press the “AUTO” button.
2. Press the “MATH” button to enter the “MATH” menu.
3. Press the “Operation” option button to select “FFT”.
4. Press the “Source” option button to select “CH1”.
5. Press CH1 button to display CH1 menu.
6. Turn the “Time/div” knob to adjust sampling rate (at least double bigger than frequency of input signal).

7. If FFT display on full screen, press CH1 button again to remove channel waveform display.
8. Press the “CURSOR” button to enter “Cursor” menu.
9. Press the “Cursor Mode” button to select “Manual”.
10. Press the “Type” option button to select “Voltage”.
11. Press the “Source” option button to select “FFT”.
12. Press the “CurA” option button and turn the “Universal” knob to move Cursor A to the highest point of the FFT waveform.
13. Press the “CurB” option button, turn the “Universal” knob to move Cursor B to the lowest point of the FFT waveform.
14. The amplitude (ΔV) displays on the top of the left screen.

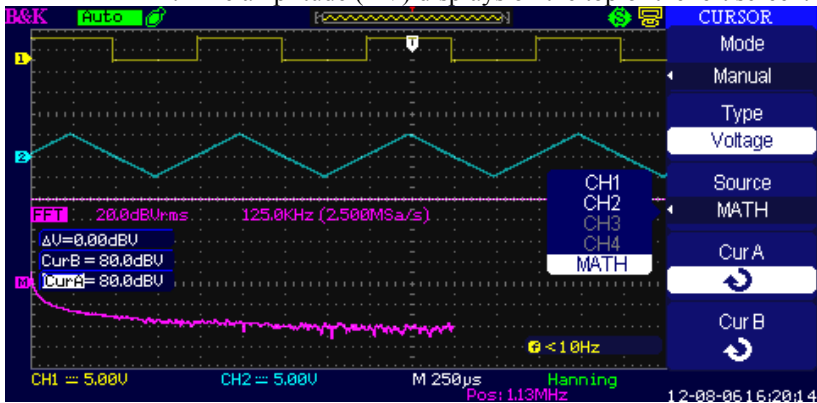

Figure 25 - Measuring FFT Amplitude

2. Measure FFT Frequency

1. Press the CURSOR button.
2. Press the “Cursor Mode” button to select “Manual”.
3. Press the “Type” option button to select “Time”.
4. Press the “Source” option button to select “FFT”.
5. Press the “CurA” option button and turn the “Universal” knob to move Cursor A to the highest position of the FFT waveform.
6. The value of CurA displaying on the top of the left screen is the highest Frequency. This frequency should be the same as input signal frequency.

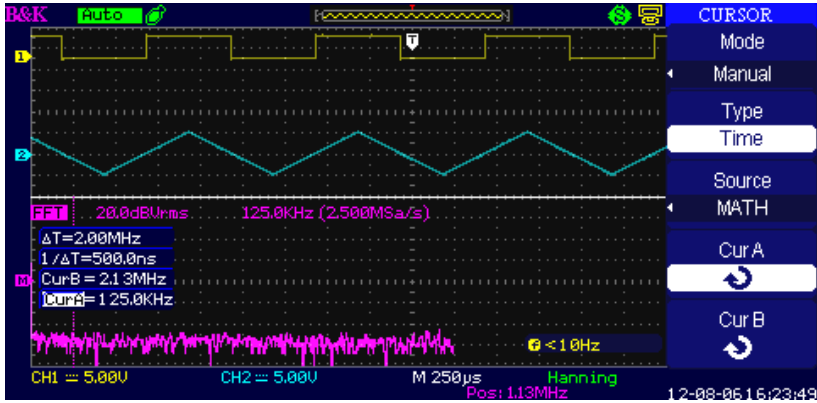

Figure 26 - Measuring FFT Frequency

NOTE: - The FFT of a waveform that has a DC component or offset can cause incorrect FFT waveform magnitude values. To minimize the DC component, choose AC Coupling on the source waveform.

- To display FFT waveforms with a large dynamic range, use the dBVrms scale. The dBVrms scale displays component magnitudes using a log scale.
- The Nyquist frequency is the highest frequency that any real-time digitizing oscilloscope can acquire without aliasing. This frequency is half that of the sample rate provided it is within the analog bandwidth of the oscilloscope. Frequencies above the Nyquist frequency will be undersampled, which causes aliasing.

Using REF

The reference control saves waveforms to a nonvolatile waveform memory. The reference function becomes available after a waveform has been saved.

Table 12 - REF Function Menu

Option	Setting	Description
Source	CH1,CH2, *CH3, *CH4 CH1 off CH2 off *CH3 off *CH4 off	Choose the waveform display to store.
REFA REFB *REFC *REFD		Choose the reference location to store or recall a waveform.
Save		Stores source waveform to the chosen reference location.
REFA REFB *REFC *REFD	On Off	Recall the reference waveform on the screen. Turn off the reference waveform.

*Available on 4CH models only

Press the Ref button to display the “Reference waveform menu”.

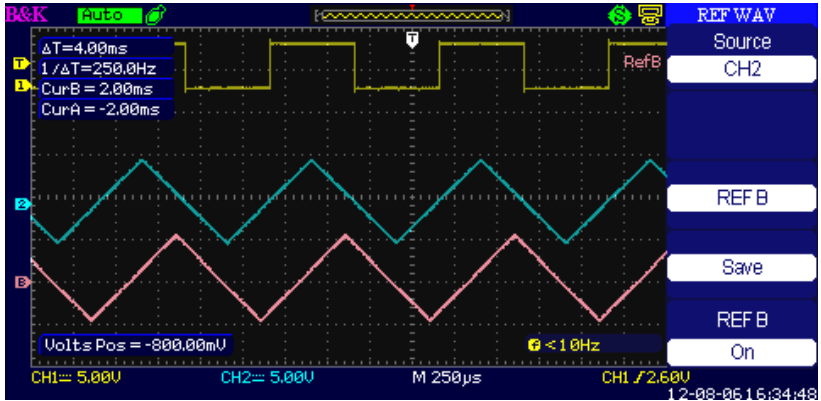

Figure 27 - Reference Waveform Menu

Operation step:

1. Press the “REF” menu button to display the “Reference waveform menu”.
2. Press the “Source” option button to select input signal channel.
3. Turn the vertical “POSITION” knob and “Volts/div” knob to adjust the vertical position and scale.
4. Press the third option button to select “REFA” or “REFB” as storage position.
5. Press the “Save” option button.
6. Press the bottom option button to select “REFA On” or “REFB On” to recall the reference waveform.

Note: - X-Y mode waveforms are not stored as reference waveforms.
 - You cannot adjust the horizontal position and scale of the reference waveform.

Horizontal System

Shown below, there is one button and two knobs in the HORIZONTAL area.

Table 13 - Horizontal System Function Menu

Option	Setting	Description
Delayed	On	Turn on this function for main timebase waveform to display on the top half screen and window
	Off	timebase waveform to display on the below half screen at the same time. Turn off this function to only display main timebase waveform on the screen.

Horizontal Control Knob

You can use the horizontal controls to change the horizontal scale and position of waveforms. The horizontal position readout shows the time represented by the center of the screen, using the time of the trigger as zero. Changing the horizontal scale causes the waveform to expand or contract around the screen center.

- **Horizontal “POSITION” knob**
 1. Adjust the horizontal position of all channels and math waveforms (the position of the trigger relative to the center of the screen). The resolution of this control varies with the time base setting.
 2. When you press the horizontal “POSITION” Knob, you can set the horizontal position to zero.
- **“Time/div” knob**

1. Used to change the horizontal time scale to magnify or compress the waveform. If waveform acquisition is stopped (using the RUN/STOP or SINGLE button), turn the Time/div knob to expand or compress the waveform.
2. Select the horizontal Time/div (scale factor) for the main or the window time base. When Window Zone is enabled, it changes the width of the window zone by changing the window time base.

- **Display scan mode:**

When the Time/div control is set to 100 ms/div or slower and the trigger mode is set to Auto, the oscilloscope enters the scan acquisition mode. In this mode, the waveform display updates from left to right. There is no trigger or horizontal position control of waveforms during scan mode.

Window Zone

Use the Window Zone option to define a segment of a waveform to see more detail. This function behaves like zooming into a portion of the captured waveform. The window time base setting cannot be set slower than the Main time base setting.

You can turn the Horizontal Position and Time/div controls to enlarge or minimize waveforms in the Window Zone.

If you want to see a section of the waveform in details, follow these steps:

1. Press the “HORI MENU” button to enter the “Horizontal menu”.
2. Turn the “Time/div” knob to change the main timebase scale.
3. Press the “Delayed” option button to select “On”.

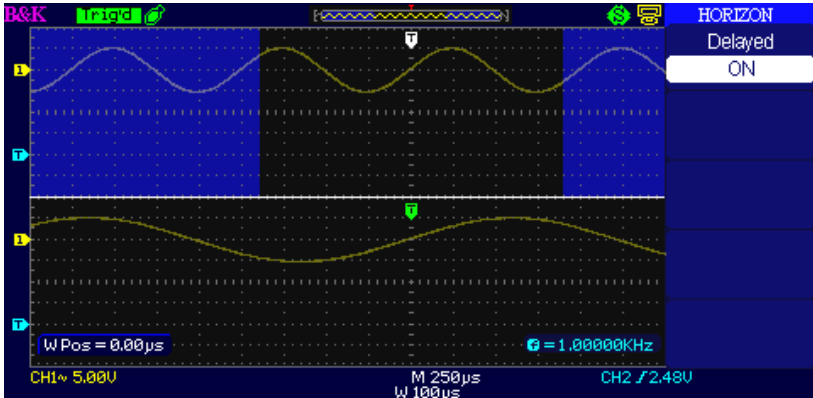

Figure 28 - Horizontal Delay Menu

4. Turn the “Horizontal Position” knob (adjust window’s position) to select the window that you need and expanded window waveform display will show on the below half of the screen at the same time.

Trigger System

The trigger determines when the oscilloscope starts to acquire data and display a waveform. When a trigger is set up properly, the oscilloscope converts unstable displays or blank screens into meaningful waveforms. Here are three buttons and one knob in the trigger area. See below:

- **“TRIG MENU” Button:** Press the “TRIG MENU” Button to display the “Trigger Menu”.
- **“LEVEL” Knob:** The LEVEL knob is to set the corresponding signal voltage of trigger point in order to sample. Press the “LEVEL” knob to set trigger level to zero.
- **“SET TO 50%” Button:** Use the “SET TO 50%” button to stabilize a waveform quickly. The oscilloscope can set the Trigger Level to be about halfway between the minimum and maximum voltage levels automatically. This is useful when you connect a

signal to the EXT TRIG BNC and set the trigger source to Ext or Ext/5.

- **“FORCE Button:** Use the FORCE button to complete the current waveform acquisition whether the oscilloscope detects a trigger or not. This is useful for SINGLE acquisitions and Normal trigger mode.

Signal Source

You can use the Trigger Source options to select the signal that the oscilloscope uses as a trigger. The source can be any signal connected to a channel BNC, to the EXT TRIG BUS, or the AC power line (available only with Edge Trigger).

Trigger Type

The scopes have five trigger types: Edge, Video, Pulse, Slope, and Alternate.

Edge Trigger

Use Edge triggering to trigger on the edge of the oscilloscope input signal at the trigger threshold.

Table 14 - Edge Trigger Function Menu

Option	Setting	Description
Type	Edge	With Edge highlighted, the rising or falling edge of the input signal is used for the trigger.
Source	CH1 CH2 *CH3 *CH4	Triggers on a channel whether or not the waveform is displayed.

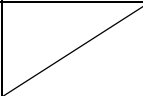
	EXT	Does not display the trigger signal; the Ext option uses the signal connected to the EXT TRIG front-panel BNC and allows a trigger level range of -1.2 V to +1.2 V.
	EXT/5	Same as Ext option, but attenuates the signal by a factor of five, and allows a trigger level range of +6 V to -6 V. This extends the trigger level range.
	AC Line	This selection uses a signal derived from the power line as the trigger source; trigger coupling is set to DC and the trigger level to 0 volts.
Slope		<p>Trigger on Rising edge of the trigger signal.</p> <p>Trigger on Falling edge of the trigger signal.</p> <p>Trigger on Rising edge and Falling edge of the trigger signal.</p>
Mode	Auto	Use this mode to let the acquisition free-run in the absence of a valid trigger. This mode scans waveform at 100 ms/div or slower time base settings.
	Normal	Use this mode when you want to see only valid triggered waveforms; when you use this mode, the oscilloscope does not display a waveform until after the first trigger.
	Single	When you want the oscilloscope to acquire a single capture of a waveform, press the “SINGLE” button.
Set up		Enter the “Trigger Setup Menu” (See below table).

*Available for 4CH models only.

Table 15 - Trigger Setup Function Menu

Option	Setting	Description
Coupling	DC	Passes all components of the signal

	AC	Blocks DC components, attenuates signals below 25 Hz.
	HF Reject	Attenuates the high-frequency components above 150 kHz.
	LF Reject	Blocks the DC component attenuates the low-frequency components below 8 kHz.
Holdoff ↻		Using the “universal” knob to adjust holdoff time (sec), the holdoff value is displayed.
Holdoff Reset		Reset holdoff time to 100 ns.
Return		Return to the first page of “Trigger main menu”.

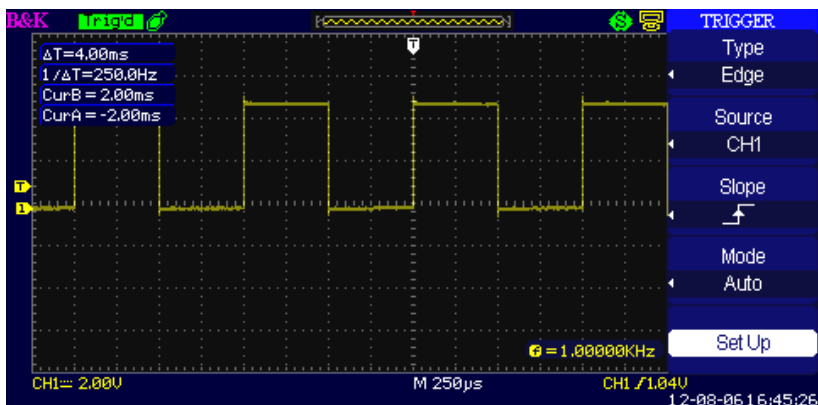

Figure 29 - Trigger Menu Screen

Operating Instructions:



1. Set up Type

- Press the “TRIG MENU” button to display “Trigger” menu.
- Press the “Type” option button to select “Edge”.

2. Set up Source

According to the input signal, press the “Source” option button to select “CH1”, “CH2”, “CH3”, “CH4”, “EXT”, “EXT/5” or “AC Line”. (CH3 and CH4 available for 4CH models only)

3. Set up Slope

Press the “Slope” option button to select “  ”, “  ” or “  ”.

4. Set up Trigger mode

Press the “Trigger mode” option button to select “Auto”, “Normal”, “Single”.

Auto: The waveform refreshes at a high speed whether the trigger condition is satisfied or not.

Normal: The waveform refreshes when the trigger condition is satisfied and waits for next trigger event occurring when the trigger condition is not satisfied.

Single: The oscilloscope acquires a waveform when the trigger condition is satisfied and then stops.

5. Set up Trigger coupling







- Press the “Set up” button to enter the “Trigger Setup Menu”.
- Press the “Coupling” option button to select “DC”, “AC”, “HF Reject” or “LF Reject”.

Pulse Trigger

Use Pulse Width triggering to trigger on aberrant pulses.

Table 16 - Pulse trigger Function Menu 1

Option	Setting	Description
Type	Pulse	Select the pulse to trigger the pulse matching the trigger condition.
Source	CH1 CH2 *CH3 *CH4 EXT EXT/5	Select input signal source.

When	 (Positive pulse width less than pulse width setting)  (Positive pulse width larger than pulse width setting)  (Positive pulse width equal to pulse width setting)  (Negative pulse width less than pulse width setting)  (Negative pulse width larger than pulse width setting)  (Negative pulse width equal to pulse width setting)	Select how to compare the trigger pulse relative to the value selected in the Set Pulse Width option.
Set Width	20.0 ns~10.0 s	Select to set up pulse width.
Next Page	Page 1/2	Press this button to enter the second page.

*Available for 4CH models only.

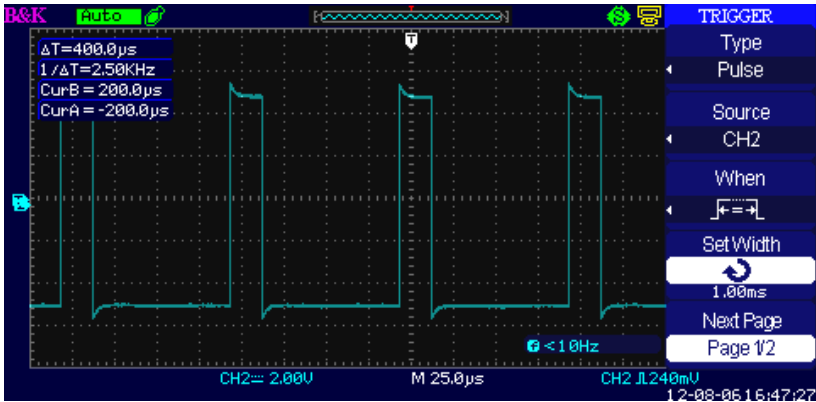

Figure 30 - Pulse Trigger Menu Screen

Table 17 - Pulse Trigger Function Menu 2

Option	Setting	Description
Type	Pulse	Select the pulse to trigger the pulse matching the trigger condition.
Mode	Auto Normal single	Select the type of triggering. Normal mode is best for most Pulse Width trigger applications.
Set up		Enter the “Trigger setup menu”.
Next Page	Page 2/2	Press this button to return to the first page.

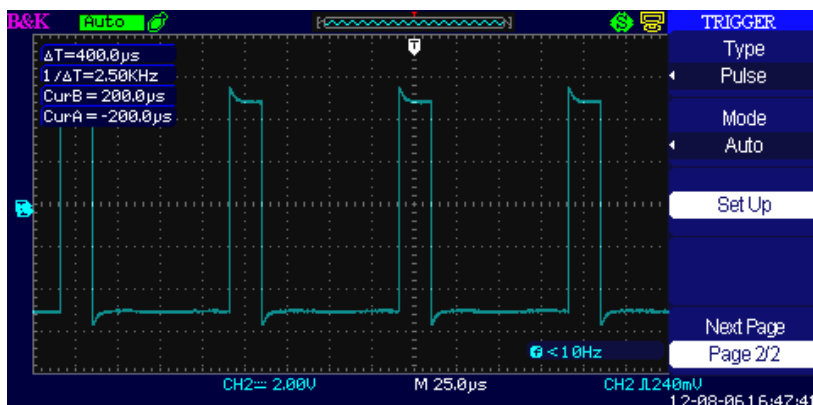







Figure 31 - Pulse Trigger Menu 2

Operating Instructions:



1. **Set up Type**
 - Press the “TRIG MENU” button to display “Trigger menu”.
 - Press the “Type” option button to select “Pulse”.
2. **Set up condition**
 - Press the “When” option button to select “”, “”, “”, “”, “” or “”.
3. **Set up pulse width**
 - Turn the “Universal” knob to set up width.

Video Trigger

Trigger on fields or lines of standard video signals.

Table 18 - Functional Menu of Video Trigger 1

*Available for 4CH models only.

Option	Setting	Description
Type	Video	Select the video type trigger. Set the coupling to AC to trigger the NTSC, PAL and SECAM video signal.
Source	CH1 CH2 *CH3 *CH4	Select the input source to be the trigger signal.
	EXT EXT/5	Ext and Ext/5 use the signal applied to the EXT TRIG connector as the source.
Polarity	 (Normal)	Normal triggers on the negative edge of the sync pulse.
	 (Inverted)	Inverted triggers on the positive edge of the sync pulse.
Sync	All lines Line Num Odd field Even Field	Select appropriate video sync.
Next Page	Page 1/2	Enter the second page of "Video trigger menu".

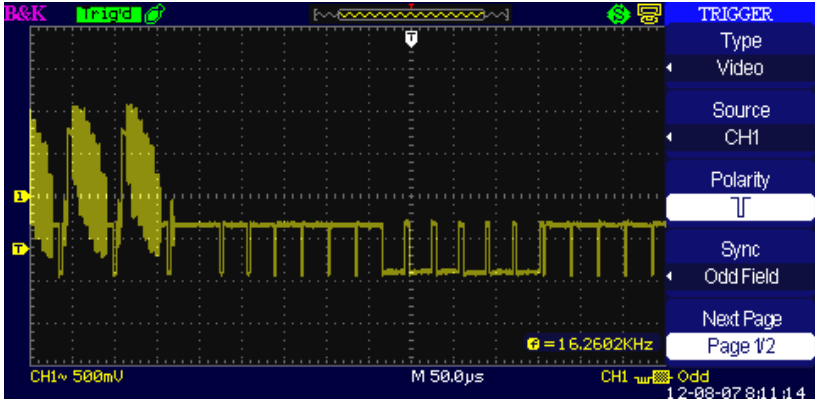

Figure 32 - Video Trigger Screen

Table 19 - Functional Menu of Video Trigger 2

Option	Setting	Description
Type	Video	Select the video type trigger. Set the coupling to AC to trigger the NTSC, PAL and SECAM video signal.
Standard	NTSC Pal/Secam	Select the video standard for sync and line number count.
Mode	Auto	Use this mode to let the acquisition free-run in the absence of a valid trigger. This mode allows an untriggered, scanning waveform at 100 ms/div or slower time base setting.
	Normal	Use this mode when you want to see only valid triggered waveforms. When you use this mode, the oscilloscope does not display a waveform until after the

		first trigger.
	Single	When you want the oscilloscope to acquire a single waveform, press the “SINGLE” button.
Set up		Enter the “Trigger setup menu”.
Next Page	Page 2/2	Return to the first page of “Video Trigger menu”.

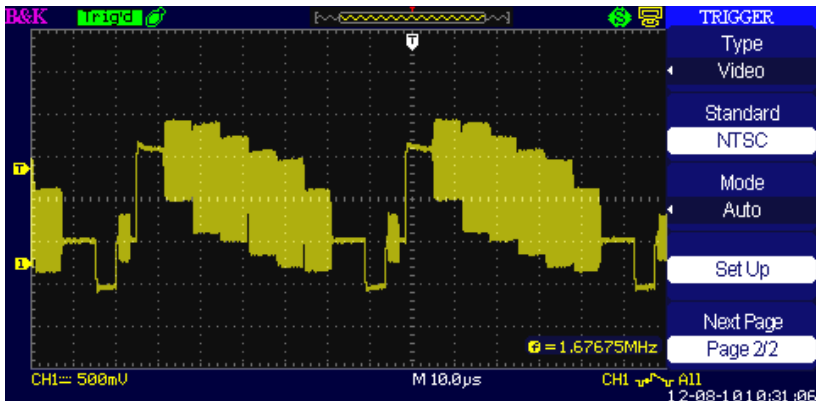



Figure 33 - Video Trigger Menu 2

Operating Instructions:

Set up Type

1. Press the “TRIG MENU” button to display “Trigger” menu.
2. Press the “Type” option button to select “Video”.

Set up Polarity

1. Press the “Polarity” option button to select “” or “.

Set up Synchronization

1. Press the “Sync” option button to select “All Lines”, “Line Num”, “Odd Field”, and “Even Field”.
2. If you select “Line Num”, you can turn the “Universal” knob to set the appointed line number.

Set up Standard



1. Press the “next Page Page2/2” option button.

2. Press the “Standard” option button to select “PAL/SECAM” or “NTSC”.

Slope Trigger

Trigger on positive slope or negative slope according to setup time of the oscilloscope.

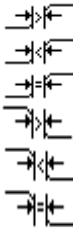
Table 20 - Slope Trigger Function Menu 1

Option	Setting	Description
Type	Slope	Trigger on positive slope or negative slope according to setup time of the oscilloscope.
Source	CH1 CH2 *CH3 *CH4 EXT EXT/5	Select trigger source.
When		Select trigger condition.
Time	 < Set Time >	Turn the “Universal” knob to set slope time. Time setup range is 20ns-10s.
Next Page	Page 1/2	Enter the second page of slope trigger menu.

*Available for 4CH models only.

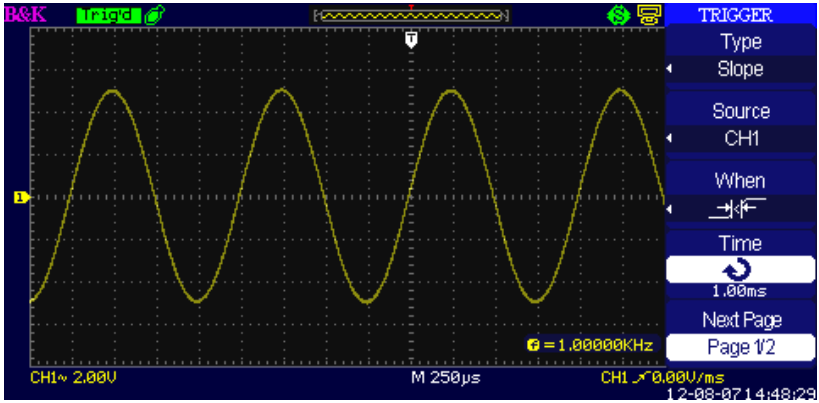



Figure 34 - Slope Trigger Menu

Table 21 - Slope Trigger Function Menu 2

Option	Setting	Description
Type	Slope	Trigger on positive slope or negative slope according to setup time of the oscilloscope.
Vertical		Select the trigger level that can be adjusted by “LEVEL” knob. You can adjust “LEVEL A”, “LEVEL B” or adjust them at the same time.
Mode	Auto	Use this mode to let the acquisition

		free-run in the absence of a valid trigger. This mode allows an untriggered, scanning waveform at 100 ms/div or slower time base setting.
	Normal	Use this mode when you want to see only valid triggered waveforms. When you use this mode, the oscilloscope does not display a waveform until after the first trigger.
	Single	When you want the oscilloscope to acquire a single waveform, press the “SINGLE” button.
Set up		Enter the “Trigger setup menu”
Next Page	Page 2/2	Return to the first page of slope trigger menu.

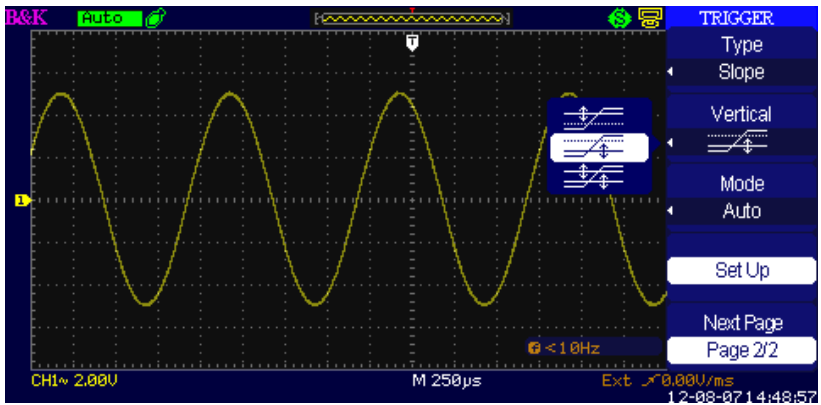







Figure 35 - Slope Trigger Menu 2

Operating Instructions:

Follow next steps if you select “Slope trigger”:

1. Input a signal to one of the channel inputs.
2. Press the “AUTO” button.

3. Press the “TRIG MENU” button to enter “Trigger menu”.
4. Press the “Type” option button to select “Slope”.
5. Press the “Source” option button to select “CH1”, “CH2”, “CH3”, or “CH4”. (CH3 and CH4 available for 4CH models only)
6. Press the “When” option button to select “”, “”, “”, “”, “” or “”.
7. Press the “Time” button and turn the “Universal” knob to adjust slope time.
8. Press the “Next Page - Page 1/2” option button to enter the second page of the “Slope trigger menu”.
9. Press the “Vertical” option button to select a trigger level that can be adjusted.
10. Turn the “LEVEL” knob.

Alternate Trigger

The trigger signal comes from two vertical channels when you use alternate trigger. In this mode, you can observe two unrelated signals at the same time. You can select different trigger types for two vertical signals. Different types include edge, pulse, video, and slope trigger. Trigger information for both channels will display on the bottom right of the screen.

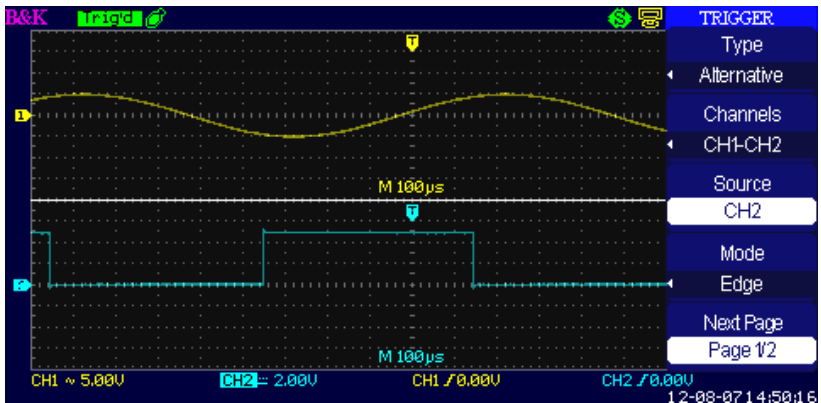

Figure 36 - Alternate Trigger Menu

Table 22 - Set Trigger Mode to Edge Trigger Function Menu 1

Option	Setting	Description
Type	Alternate	The trigger signal comes from two vertical channels when you use alternative trigger. In this mode, you can observe two irrelative signals at the same time.
Channels	CHX-CHY	Select any two channels from CH1, CH2, *CH3, or *CH4 as the sources for alternating trigger.
Source	CH1, CH2, *CH3, *CH4	Selects the source channel.
Mode	Edge	Set trigger type of the vertical channel signal to Edge.
Next Page	Page 1/2	Go to the second page of the TRIGGER Menu.

*Available for 4CH models only.

Option	Setting	Description
Slope		Triggering on rising edge. Triggering on falling edge. Triggering on rising edge and falling edge.
Set Up		Enter the "Trigger setup menu"
Next Page	Page 2/2	Go back to the first page of the TRIGGER menu.

Table 23 - Set Trigger Mode to Pulse Trigger Function Menu 1

Option	Setting	Description
Type	Alternate	The trigger signal comes from two vertical channels when you use alternative trigger. In this mode, you can observe two irrelative signals at the same time.
Channels	CHX-CHY	Select any two channels from CH1, CH2, *CH3, or *CH4 as the sources for alternating trigger.
Source	CH1, CH2, *CH3, *CH4	Selects the source channel.
Mode	Pulse	Set trigger type of the vertical channel signal (selected by Source) to Pulse trigger.
Next Page	Page 1/2	Enter the second page of Alternative trigger menu.

*Available for 4CH models only.

Table 24 - Set Trigger Mode to Pulse Trigger Function Menu 2



Option	Setting	Description
When		Select how to compare the trigger pulse relative to the value selected in the Set Pulse Width option.
Set Width	20.0 ns~10.0 s	Selecting this option can turn the universal to set up the pulse width.
Set up		Enter the “Trigger Setup Menu”
Next Page	Page 2/2	Press this button to return to the first page.

Table 25 - Set Trigger Mode to Video Trigger Function Menu 1

Option	Setting	Description
Type	Alternate	The trigger signal comes from two vertical channels when you use alternate trigger. In this mode, you can observe two unrelated signals at the same time.
Channels	CHX-CHY	Select any two channels from CH1, CH2, *CH3, or *CH4 as the sources for alternating trigger.
Source	CH1, CH2, *CH3, *CH4	Selects the source channel.
Mode	Video	Set trigger type of the vertical channel signal to Video trigger.
Next Page	Page 1/2	Enter the second page of Alternate trigger menu.

*Available for 4CH models only.

Table 26 - Set Trigger Mode to Video Trigger Function Menu 2

Option	Setting	Description
Polarity	 (Normal)  (Inverted)	Normal triggers on the negative edge of the sync pulse. Inverted triggers on the positive edge of the sync pulse.
Sync	All lines Line Num Odd field Even Field	Select appropriate video sync.



Standard	NTSC Pal/Secam	Select the video standard for sync and line number count.
Set up		Enter the “Trigger Setup Menu”
Next Page	Page 2/2	Enter the second page of Alternatetrigger menu.

Table 27 - Set Trigger Mode to Slope Trigger Function Menu 1

Option	Setting	Description
Type	Alternative	The trigger signal comes from two vertical channels when you use alternative trigger. In this mode, you can observe two irrelative signals at the same time.
Channels	CHX-CHY	Select any two channels from CH1, CH2, *CH3, or *CH4 as the sources for alternating trigger.
Source	CH1, CH2, *CH3, *CH4	Selects the source channel.
Mode	Slope	Set trigger type of the vertical channel signal to slope trigger.
Next Page	Page 1/2	Enter the second page of the alternate trigger.

*Available for 4CH models only.

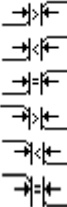
Table 28 - Set Trigger Mode to Slope Trigger Function Menu 2

Option	Setting	Description
When		Select slope trigger condition.
Time	 (Set time)	Turn the “Universal” knob to set the slope time. Time setup range is 20ns-10s.

Vertical		Select the trigger level that can be adjusted by “LEVEL” knob. You can adjust “LEVEL A”, “LEVEL B” or adjust them at the same time. Selections depend on slope trigger condition.
Set up	/	Enter the “Trigger setup menu”.
Next Page	Page 2/2	Return to the first page of “Alternate trigger menu”.

Operation Instructions:

To observe two irrelative channel signals, follow these steps :

1. Input two irrelative signals to channel 1 and channel 2.
2. Press the AUTO button.
3. Press the TRIG MENU button to enter “trigger menu”.
4. Press the “Type” option button to select “Alternate”.
5. Press the “Channels” option button to select “CH1-CH2”.
6. Press the “Source” option button to select “CH1”.
7. Press the CH1 button and turn the “Time/div” knob to optimize waveform display.
8. Press “Mode” option button to select “Edge”, “Pulse”, “Slope” or “Video”.
9. Set the trigger according to trigger edge.
10. Press the “Source” option button to select “CH2”.
11. Press the CH2 button and turn the “Time/div” knob to optimize waveform display.
12. Repeat steps 8 and 9.

Coupling

Use “Coupling” to make sure the signal passes through the trigger circuit. It is useful for obtaining a steady waveform.

If you use trigger coupling, you should press the “TRIGGER” button and then select “Edge”, “Pulse”, “Video”, or “Slope” trigger. Then select the “coupling” option in the “Set Up menu”.

Position

The horizontal position control establishes the time between the trigger position and the screen center. You can adjust the horizontal “POSITION” knob control to view waveform data before the trigger, after the trigger, or some of each. When you change the horizontal position of a waveform, you are changing the time between the trigger and the center of the display. (This appears to move the waveform to the right or left on the display.)

Slope and Level

The Slope and Level controls help to define the trigger. The Slope option (Edge trigger type only) determines whether the oscilloscope finds the trigger point on the rising or the falling edge of a signal.

The TRIGGER LEVEL knob controls where on the edge the trigger point occurs.

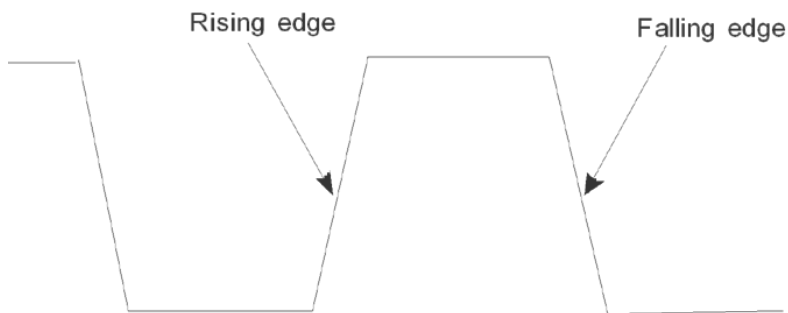

Figure 37 - Rise and Fall Edge

- Note:**
- Press the SINGLE button when you want the oscilloscope to acquire a single waveform.
 - Trigger coupling affects only the signal passed to the trigger system. It does not affect the bandwidth or coupling of the signal displayed on the screen.
 - Normal Polarity Sync triggers always occur on negative-going horizontal sync pulses. If the video waveform has positive-going horizontal sync pulses, use the Inverted Polarity selection.

Trigger Holdoff

You can use the Trigger Holdoff function to produce a stable display of complex waveforms. Holdoff is time between when the oscilloscope detects one trigger and when it is ready to detect another. The oscilloscope will not trigger during the holdoff time. For a pulse train, you can adjust the holdoff time so the oscilloscope triggers only on the first pulse in the train.

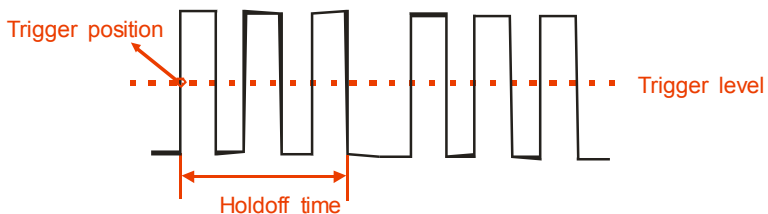

Figure 38 - Trigger Holdoff

If you want to change holdoff time, please follow the steps below:

1. Press the “TRIG MENU” button to show the “TRIG Menu”.
2. Press the “Type” option button to select trigger type.
3. Press the “Set Up” option button to enter the

“Trigger setup menu”.

4. Press the “Holdoff” option button and turn the “Universal” knob to change the holdoff time until the waveform triggers steadily.

Note • Use trigger holdoff to help stabilize the display of a periodic waveform.

Signal Acquisition System

Shown below is the “ACQUIRE” button for entering the menu for “Acquiring Signals”.

Table 29- Acquiring Signals Function Menu

Option	Setting	Description
Acquisition	Sampling	Use for sampling and accurately display most of the waveform.
	Peak Detect	Detect the noise and decrease the possibility of aliasing.
	Average	Use to reduce random or uncorrelated noise in the signal display.
	Averages (4, 16, 32, 64, 128, 256)	Select number of averages.
Sinx/x	Sinx x	Use sine interpolation. Use linear interpolation.
Mode	Equ time	Set the Sampling mode to Equivalent time.
	Real time	Set the Sampling mode to Real time.

Sa Rate	/	Displays system sampling rate.
---------	---	--------------------------------

When you acquire a signal, the oscilloscope converts it into digital form and displays a waveform. The acquisition mode defines how the signal is digitized and the time base setting affects the time span and level of detail in the acquisition.

- Sampling:** In this acquisition mode, the oscilloscope samples the signal in evenly spaced intervals to construct the waveform. This mode accurately represents signals most of the time.

Advantage: You can use this mode to reduce random noise.

Disadvantage: This mode does not acquire rapid variations in the signal that may occur between samples. This can result in aliasing, which may cause narrow pulses to be missed. In these cases, you should use the Peak Detect mode to acquire data.

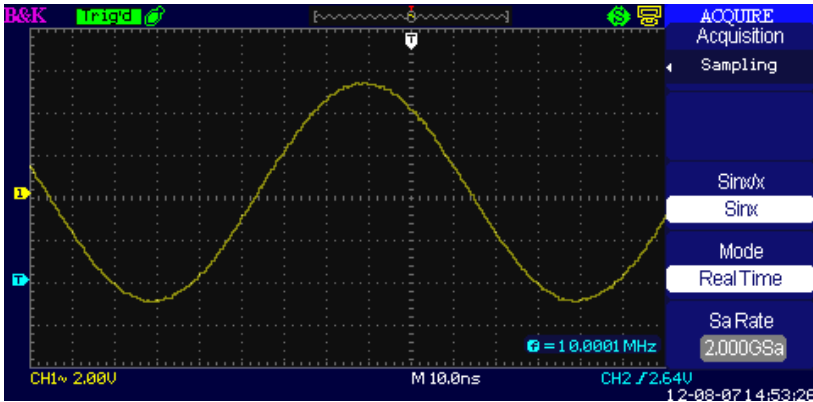

Figure 39 - Acquire Menu

- Peak Detect:** Peak Detect mode capture the maximum and minimum values of a signal Finds highest and lowest record points over many acquisitions.

Advantage: In this way, the oscilloscope can acquire and display narrow pulses, which may have otherwise been missed in Sample mode.

Disadvantage: Noise will appear to be higher in this mode.

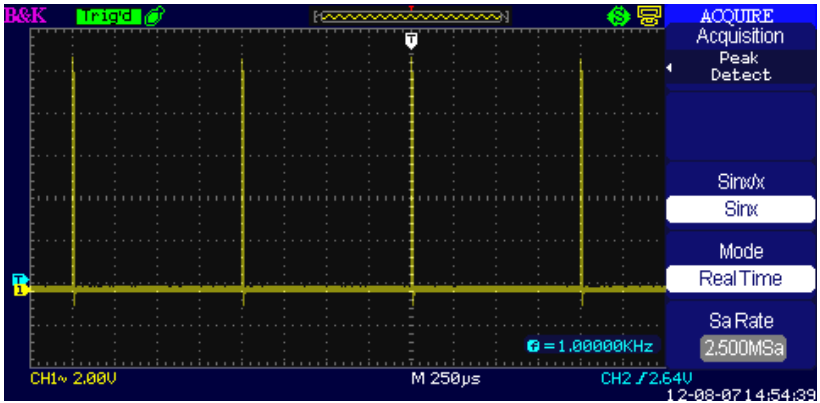

Figure 40 - Peak Detect

- **Average:** The oscilloscope acquires several waveforms, averages them, and displays the resulting waveform.
Advantage: You can use this mode to reduce random noise.

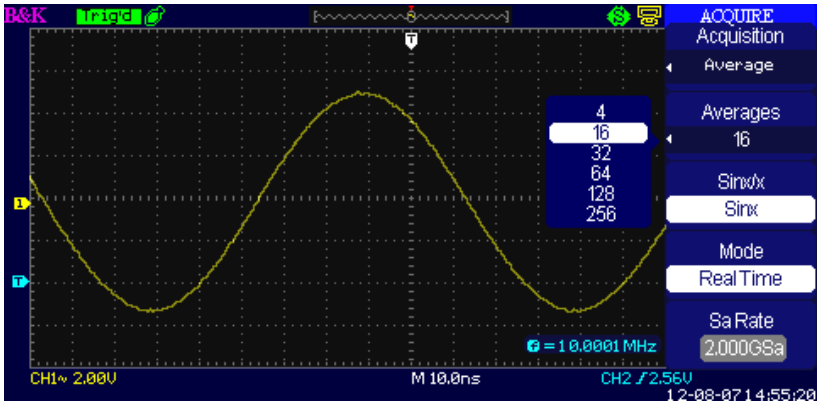

Figure 41 - Acquisition Averaging Screen

- **Equivalent Time Sampling:** The equivalent time sampling mode can achieve up to 50 GSa/s. This mode is useful for observing repetitive waveforms.
- **Real Time Sampling:** The oscilloscope's maximum real-time sampling rate is 2 GSa/s.

- **“RUN/STOP” Button:** Press the RUN/STOP button when you want the oscilloscope to acquire waveforms continuously. Press the button again to stop the acquisition.
- **“SINGLE” Button:** Press the SINGLE button to acquire a single waveform. Each time you push the SINGLE button, the oscilloscope begins to acquire another waveform. After the oscilloscope detects a trigger it completes the acquisition and stops.

When you push the RUN/STOP or SINGLE buttons to start an acquisition, the oscilloscope goes through the following steps:

1. Acquire enough data to fill the portion of the waveform record to the left of the trigger point. This is also called the pre-trigger.
 2. Continue to acquire data while waiting for the trigger condition to occur.
 3. Detect the trigger condition.
 4. Continue to acquire data until the waveform record is full.
 5. Display the newly acquired waveform.
- **Time Base:** The oscilloscope digitizes waveforms by acquiring the value of an input signal at discrete points. The time base allows you to control how often the values are digitized. To adjust the time base to a horizontal scale that suits your purpose, use the Time/div knob.
 - **Time Domain Aliasing:** Aliasing occurs when the oscilloscope does not sample the signal fast enough to construct an accurate waveform record. When this happens, the oscilloscope displays a waveform with a frequency lower than the actual input waveform, or triggers and displays an unstable waveform.

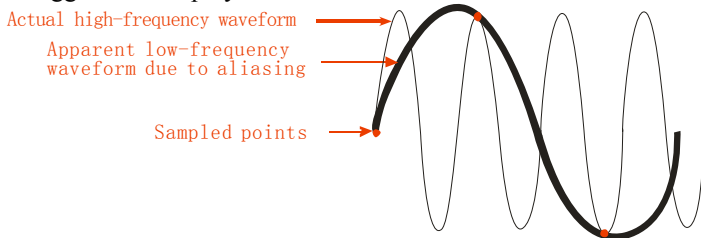

Figure 42 - Time Domain Aliasing

Operating Instructions:

Set up Sampling Format

You can press the “Acquisition” option button or turn the “Universal” knob to select “Sampling” mode, “Peak Detect” mode or “Average” mode.

Set up Averages

When you select “Average” format, you can press the “Averages” option button to select “4”, “16”, “32”, “64”, “128” or “256”.

Set up function interpolation

You can select Sinx interpolation or linear interpolation.

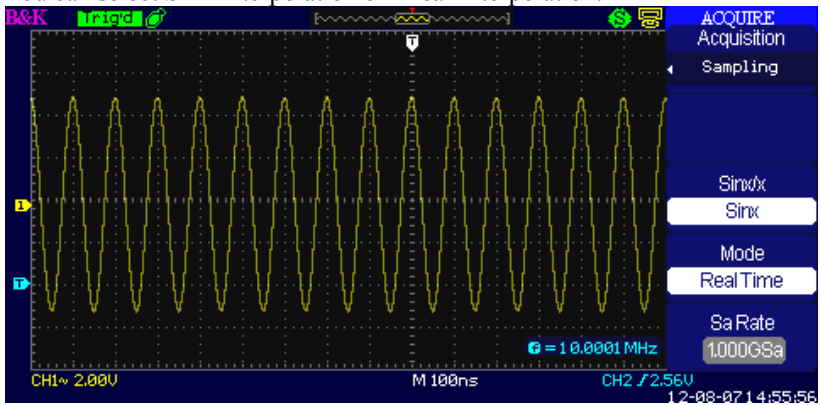

Figure 43 - Sine Interpolation

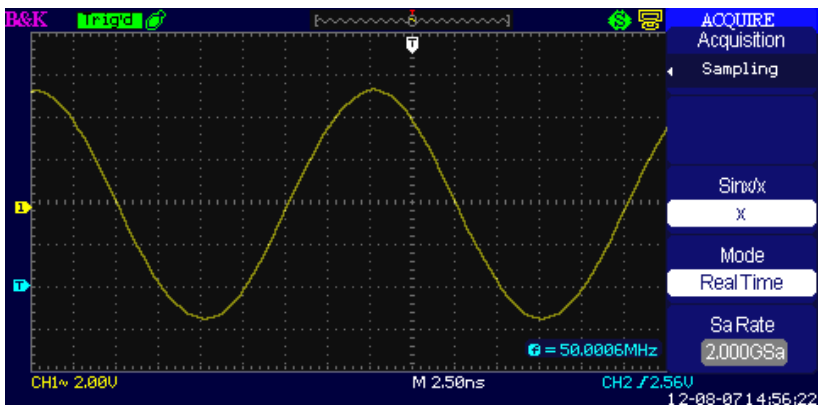

Figure 44 - Linear Interpolation

Set up Sampling mode

Press the “Mode” option button to select “Real Time” or “Equ Time”.



Set up Sampling rate

Adjust the sampling rate by pressing the “Sa Rate” option button and turning the Time/div front panel knob. The sampling rate is shown at the corresponding timebase scale.

Display System

The display function can be setup by pressing the “DISPLAY” button.

Table 30- Display System Function Menu 1

Option	Setting	Description
Type	Vectors Dots	Vectors: Fills the space between adjacent sample points in the display. Dots: There is no link between adjacent sample points.
Persist	Off 1 sec 2 sec 5 sec Infinite	Sets the length of time each displayed sample point remains displayed.
Intensity	 <Intensity>	Set waveforms' intensity.
Brightness	 <Brightness>	Set grid brightness.
Next Page	Page 1/3	Press this button to enter second page.

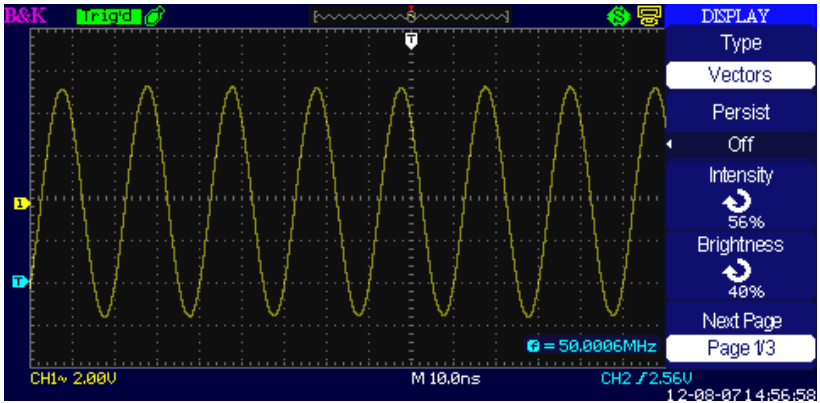





Figure 45 - Display Menu Screen

Table 31 - Display System Function Menu 2

Option	Setting	Description
Format	YT XY	YT format displays the vertical voltage in relation to time (horizontal scale). XY format displays a dot each time a sample is acquired on channel 1 and channel 2.
Screen	Normal Inverted	Set to normal mode. Set to invert color display mode.
Grid	  	Display grids and axes on the screen. Turn off the grids. Turn off the grids and axes.
Menu Display	2sec 5sec 10sec	Set menu display time on screen.

	20sec Infinite	
Next Page	Page 2/3	Press this button to enter the second page of “Display menu”.

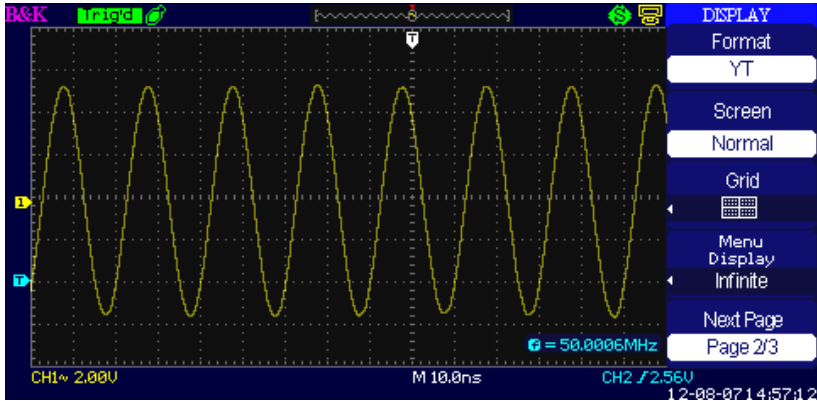

Figure 46 - Display Menu 2

Table 32 - Display System Function Menu 3

Option	Setting	Description
Skin	Classical Modern Tradition Succinct	Set up screen style.
Next Page	Page 3/3	Press this button to return to the first page.

Operation Introduction:

Setup waveform display type

1. Press the “DISPLAY” button to enter the “Display” menu.
2. Press the “Type” option button to select “Vectors” or “Dots”.

Set up Persist

Press the “Persist” option button to select “Off”, “1 Sec”, “2 Sec”, “5 Sec” or “Infinite”. You can use this option to observe some special waveforms.

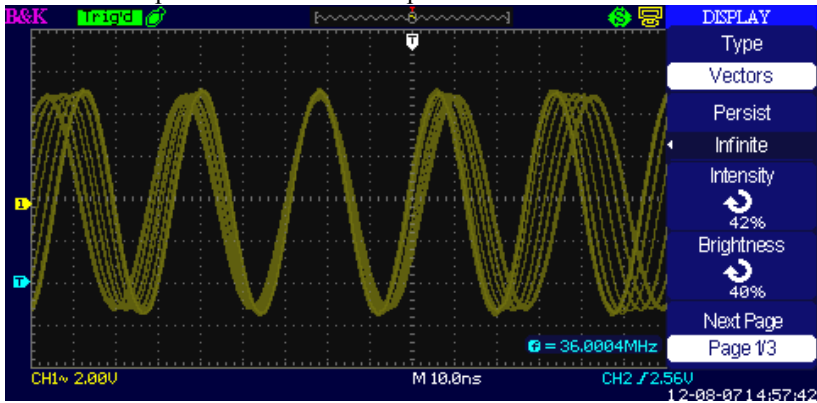

Figure 47 - Persist Screen

Setup Intensity

Press the “Intensity” option button and turn the “Universal” knob to adjust waveforms’ intensity.

Setup Brightness

Press the “Brightness” option button and turn the “Universal” knob to adjust grid brightness.



Setup Display Format

1. Press the “Next Page” option button to enter second display menu.
2. Press the “Format” option button to select “YT” or “XY”

Setup Screen

Press the “Screen” option button to select “Normal” or “Inverted” to set the screen display color.

Setup Grid

Press the “Grid” option button to select “”, “” or “” to set the screen whether to display grid or not.

Setup Menu Display

Press the “Menu Display” option button to select “2 sec”, “5 sec”, “10 sec”, “20 sec”, or “Infinite” to set menu display time on screen.

Set Skin

Press the “skin” option button or turn the “Universal” knob to select “Classical”, “Modern”, “Traditional”, or “Succinct”.

X-Y Format

Use the XY format to analyze phase differences, such as those represented by Lissajous patterns. The format plots the voltage on channel 1 against the voltage on channel 2, where channel 1 is the horizontal axis and channel 2 is the vertical axis. The oscilloscope uses the untriggered Sample acquisition mode and displays data as dots.

Note: The oscilloscope can capture a waveform in normal YT mode at any sampling rate. You can view the same waveform in XY mode. To do so, stop the acquisition and change the display format to XY.

Operation steps:

- Channel 1 (or channel 3) “Volts/div” and vertical “POSITION” set up the horizontal scale and position.
- Channel 2 (or channel 4) “Volts/div” and vertical “POSITION” set up the horizontal scale and position.
- Turn the “Time/div” knob to adjust the sampling rate
- The following functions are forbidden at XY display form:
 - Benchmark waveform and wave mathematics
 - Cursor

- Auto (resets display format to YT)
- Trigger Control
- Horizontal Position Knob
- Vector Display Type
- Scan Display

Note: When the display type is set to Vector, the oscilloscope connects the sample points by using digital interpolation. Interpolation mode contains linear interpolation and $\sin(x)/x$ interpolation. $\sin(x)/x$ interpolation is suitable for reconstructing curved or irregular wave shapes, especially when the sample rate is 3 to 5 times the system bandwidth or at faster time base settings.

Measure System

The oscilloscope displays the voltage in relation to time and tests the waveform displayed. Different measurement techniques such as scale, cursor, and auto measure modes are used.

Scale Measurement

This method allows you to make a quick visual estimate. For example, you might look at waveform amplitude and determine that it is a little more than 100 mV. You can take simple measurements by counting the major and minor graticule divisions involved and multiplying by the scale factor. For example, if you counted five major vertical graticule divisions between minimum and maximum values of a waveform and knew you had a scale factor of 100 mV/div, then you could easily calculate your peak-to-peak voltage as follows:



$$5 \text{ divisions} \times 100 \text{ mV/div} = 500 \text{ mV}$$

Cursor Measurement

The cursor measurement has three modes: Manual, Track, and Auto Measure.

Manual Mode

Table 33 - Manual Cursor Function Menu

Option	Setting	Description
Cursor Mode	Manual	Manually adjust cursors for measurement.
Type	Voltage Time	Use cursor to measure voltage parameters. Use cursor to measure time parameters.
Source	CH1 CH2 *CH3 *CH4 MATH/FFT REFA REFB *REFC *REFD	Select input signal channel.
Cur A 		Select this option, turn the “Universal” knob to adjust cursor A.
Cur B 		Select this option, turn the “Universal” knob to adjust cursor B.

*Available for 4CH models only.

In this mode, the screen displays two horizontal parallel cursors or vertical parallel cursors to measure voltage or time. You can move the cursor by turning the “Universal” knob. Before using cursors, you should make sure that you have set the signal source as the channel for measuring.

- **Voltage Cursor:** Voltage cursors appear as horizontal lines on the display and measure the vertical parameters.
- **Time Cursor:** Time cursors appear as vertical lines on the display and measure the horizontal parameters.
- **Cursor Moving:** Use the “Universal” knob to move cursor 1 and cursor 2. They will be moved when the corresponding cursor options are selected, and the cursor value will display on the bottom left and top left of the screen when you move the cursor.

To do manual cursor measurements, follow these steps:

1. Press CURSOR button to enter the cursor function menu.
2. Press the “Cursor Mode” option button to select “Manual”.
3. Press the “Type” option button to select “Voltage” or “Time”.
4. Press the “Source” option button to select “CH1”, “CH2”, “CH3”, “CH4”, “MATH”, “FFT”, “REFA”, “REFB”, “REFC”, “REFD”, according to input signal channel. (CH3, CH4, REFC, and REFD available for 4CH models only)
5. Select “Cur A” and turn the “Universal” knob to adjust Cursor A.
6. Select “Cur B” and turn the “Universal” knob to adjust Cursor B.
7. The measurement values are displayed on the top left corner. If the measurement type is set to “Voltage”, the values are as follows:
 The value of Cur A: Cur A
 The value of Cur B: Cur B
 The voltage difference between Cursor A and Cursor B: ΔV
 If the measurement type is set to “Time”, the values are as follows:
 The value of Cur A: Cur A
 The value of Cur B: Cur B
 The time difference between Cursor A and Cursor B: ΔT
 The reciprocal of time difference between Cursor A and Cursor B: $1/\Delta T$

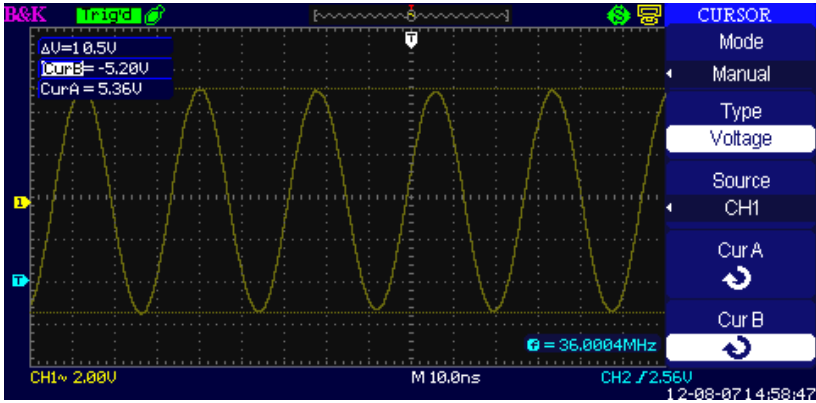

Figure 48 - Cursor Menu

Track Mode

Table 34- Track Mode Function Menu

Option	Setting	Description
Cursor Mode	Track	In this mode, set track cursor measure.
Cursor A	CH1 CH2 *CH3 *CH4 NONE	Set the input signal channel that the Cursor A will measure.
Cursor B	CH1 CH2 *CH3 *CH4 NONE	Set the input signal channel that the Cursor B will measure.
Cur A ↻		Select this option, turn the “Universal” knob to adjust horizontal coordinate of Cursor A.
Cur B ↻		Select this option, turn the “Universal” knob to adjust horizontal coordinate of Cursor B.

*Available for 4CH models only.

In this mode, the screen displays two cross cursors. The cross cursor sets the position on the waveform automatically. You could adjust the cursor’s

horizontal position on the waveform by turning the “Universal” knob. The oscilloscope displays the values on the top left of the screen.

To do track cursor measurement, follow these steps:

1. Press CURSOR button to enter the cursor measure function menu.
2. Press the “Cursor Mode” option button to select “Track”.
3. Press the “Cursor A” option button to select the input signal channel.
4. Press the “Cursor B” option button to select the input signal channel.
5. Select “Cur A”, turn the “Universal” knob to move Cursor A horizontally.
6. Select “Cur B”, turn the “Universal” knob to move Cursor B horizontally.
7. The measurement values are displayed on the left of the top corner:

A → T: The horizontal position of Cursor A (Time cursor centered around the midpoint of screen)

A → V: The vertical position of Cursor A (Voltage cursor centered around channel ground level)

B → T: The horizontal position of Cursor B (Time cursor centered around the midpoint of the screen)

B → V: The vertical position of Cursor B (Voltage cursor centered around the channel ground level)

ΔT : Horizontal space between Cursor A and Cursor B (Time value between two cursors).

$1/\Delta T$: The reciprocal of horizontal space between cursor A and cursor B.

ΔV : Vertical space between Cursor A and Cursor B (Voltage value between two cursors).

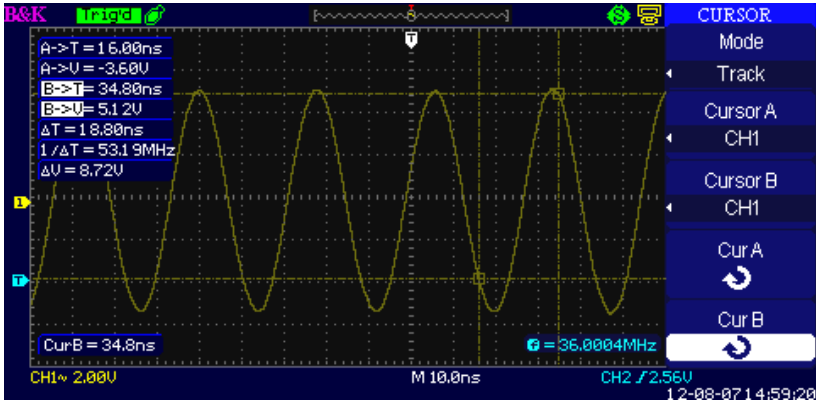

Figure 49 - Cursor Menu

Auto Mode

Table 35 - Auto Mode Function Menu

Option	Setting	Description
Cursor Mode	Auto	Set to auto cursor measure mode.

This mode will take effect with automatic measurements. The instruments will display cursors while measuring parameters automatically.

To do auto cursor measurements, follow these steps:

1. Press the CURSOR button to enter “Cursor measure menu”.
 2. Press the “Cursor Mode” option button to select “Auto”.
- Press the “MEASURE” button to enter “Auto cursor measure mode menu” to select the parameter that you want to measure.

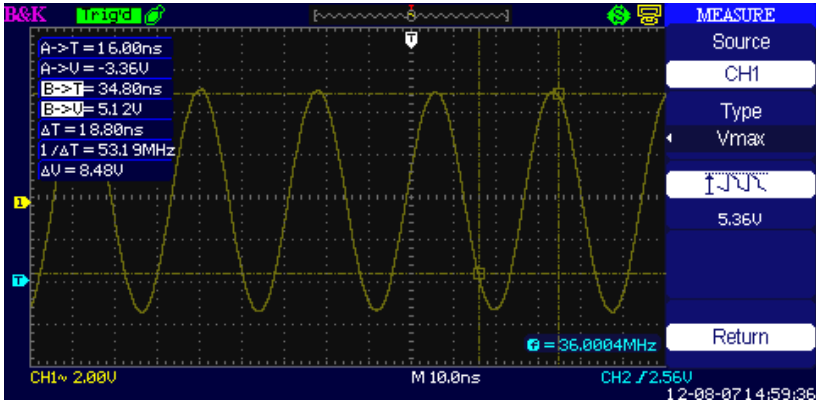

Figure 50 - Auto Mode

Auto Measurement

When you take automatic measurements, the oscilloscope does all the calculation for you. The measurements use all the recorded points in the memory, which are more accurate than measurements made using the graticule lines or cursor measurements because these measurements are confined to be made by only using points on the display and not all the data points recorded by the oscilloscope.

Press the 'MEASURE' button for Automatic Test.

There are three auto measurement types: Voltage Measure, Time Measure, and Delay Measure. There are a total of 32 measurement parameters.

Table 36 - Auto Measurement Function Menu 1

Option	Description
Voltage	Press this button to enter the Voltage measurement menu.
Time	Press this button to enter the Time measurement menu.
Delay	Press this button to enter the Delay measurement menu.
All Mea	Press this button to enter the All Measurement menu.
Return	Press this option button to return to the home page of the auto measurement menu.

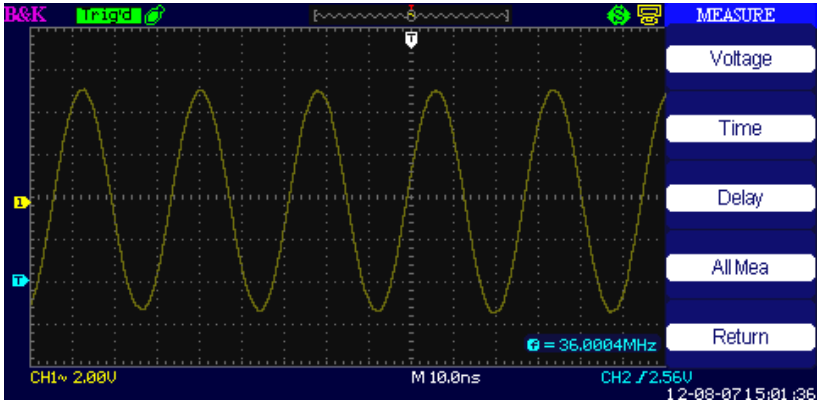

Figure 51 - Auto Measure Menu 1

Table 37 - Auto Measurement Function 2 - Voltage Measurement Menu

Option	Setting	Description
Source	CH1, CH2, *CH3, *CH4	Select input signal source for Voltage measurement.
Type	Vpp, Vmax, Vmin, Vamp, Vtop, Vbase, Vavg, Mean, Vrms, Cycle Vrms, FOVShoot, FPREShoot, ROVShoot, RPREShoot,	Press the “Type” button or turn the “Universal” knob to select Voltage measurement parameter.
		Display the corresponding icon and measurement value of your selected Voltage measurement parameter.
Return		Return to the first page of auto measurement menu.

Table 38 - Auto Measurement Function 3 - Time Measurement Menu



Option	Setting	Description
Source	CH1, CH2, *CH3, *CH4	Select input signal source for Time measurement.
Type	Freq, Period, +Width, -Width, Rise Time, Fall Time, BWidth, +Duty, -Duty	Press the “Type” button or turn the “Universal” knob to select Time measurement parameter.
		Display the corresponding icon and measurement value of your selected time measurement parameter.
Return		Return to the first page of auto measurement menu.

Table 39 - Auto Measurement Function 4 - Delay Measurement Menu

Option	Setting	Description
Source	CHX - CHY	Select any two input signal source for Delay measurement.
Type	Phase, FRR, FRF, FFR, FFF, LRR, LRF, LFR, LFF	Press the “Type” button or turn the “Universal” knob to select Delay measurement parameter.
		Display the corresponding icon and measure value of your selected Delay measurement parameter.

		
Return		Return to the first page of auto measurement menu.

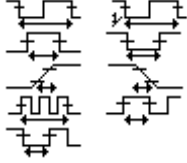
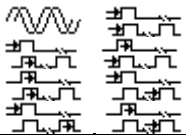



*Available for 4CH models only.















Table 40 - All Measurement Function Menu













Option	Setting	Description
Source	CH1 CH2 *CH3 *CH4	Select input signal channel.
Voltage	On Off	Turn on the all measurement function to measure voltage parameters. Turn of the all measurement function to measure voltage parameters.
Time	On Off	Turn on the all measurement function to measure Time parameters. Turn of the all measurement function to measure Time parameters.
Return		Return to the “All Measurements main menu”.

*Available for 4CH models only.

Table 41 – Types of Measurements

Measure Type	Description
 Vpp	Measures the absolute difference between the maximum and minimum peaks of the entire waveform.
 Vmax	The most positive peak voltage measured over the entire waveform.
 Vmin	The most negative peak voltage measured over the entire waveform.
 Vamp	Voltage between Vhigh and Vlow of a waveform.

 Vtop	Measures the highest voltage over the entire waveform.
 Vbase	Measures the lowest voltage over the entire waveform.
 Vavg	The arithmetic mean over the first cycle in the waveform.
 Mean	The arithmetic mean over the entire waveform.
 Crms	The true Root Mean Square voltage over the first cycle in the waveform.
 Vrms	The true Root Mean Square voltage over the entire waveform.
 ROVShoot	Defined as $(V_{max}-V_{high})/V_{amp}$ after the waveform rising.
 FOVShoot	Defined as $(V_{min}-V_{low})/V_{amp}$ after the waveform falling.
 RPREshoot	Defined as $(V_{min}-V_{low})/V_{amp}$ before the waveform rising.
 FPREshoot	Defined as $(V_{max}-V_{high})/V_{amp}$ before the waveform falling.
FREQ	Measures the frequency of the waveform.
PRD	Measures the period of the waveform.
 Rise Time	Rise Time Measures the time between 10% and 90% of the first rising edge of the waveform.
 Fall Time	Fall Time Measures the time between 90% and 10% of the first falling edge of the waveform.
 BWid	The duration of a burst. Measured over the entire waveform.
 + Wid	+ Width Measures the time between the first rising edge and the next falling edge at the waveform 50% level.

 - Wid	-Width Measures the time between the first falling edge and the next rising edge at the waveform 50% level.
 + Duty	Measures the first cycle waveform. Positive Duty Cycle is the ratio between positive pulse width and period.
 -Duty	Measures the first cycle waveform. Negative Duty Cycle is the ratio between negative pulse width and period.
 Phase	The amount one waveform leads or lags another in time. Expressed in degrees, where 360 degrees comprise one waveform cycle.
 FRR	The time between the first rising edge of source 1 and the first rising edge of source 2.
 FRF	The time between the first rising edge of source 1 and the first falling edge of source 2.
 FFR	The time between the first falling edge of source 1 and the first rising edge of source 2.
 FFF	The time between the first falling edge of source 1 and the first falling edge of source 2.
 LRR	The time between the first rising edge of source 1 and the last rising edge of source 2.
 LRF	The time between the first rising edge of source 1 and the last falling edge of source 2.
 LFR	The time between the first falling edge of source 1 and the last rising edge of source 2.
 LFF	The time between the first falling edge of source 1 and the last falling edge of source 2.

If you want to measure voltage parameters, please follow the steps below:

1. Press the “MEASURE” button to enter the “Auto measurement” menu.

2. Press the first option button to enter the “second measurement menu”.
3. Select measure type. If you press the “Voltage” option button, “Voltage measurement” menu will display on the screen.
4. Press the “Source” option button to select “CH1”, “CH2”, “CH3”, or “CH4” according to input signal channel. (CH3 and CH4 available for 4CH models only)
5. Press the “Type” option button to select the parameter type that you want to measure. The corresponding icon and value will display below the measure parameter.
6. Press the “Return” option button to return to the home page of the “Auto Measurement” menu. The selected parameter and the corresponding value will display on the top position of the home page.
You can display the other parameters and its value on the corresponding position in the same way. The screen can display up to five parameters at one time.

If you want to measure time parameters using all measure function, please follow these steps:

1. Press the “MEASURE” button to enter the “Auto Measure menu”.
2. Press the top option button to enter the second page of “Auto Measure menu”.
3. Press “All Mea” option button to enter the “All Measure menu”.
4. Press “Source” option button to select input signal channel.
5. Press the “Time” option button to select “On”. Now all of the time parameters’ values will display on the screen at the same time.

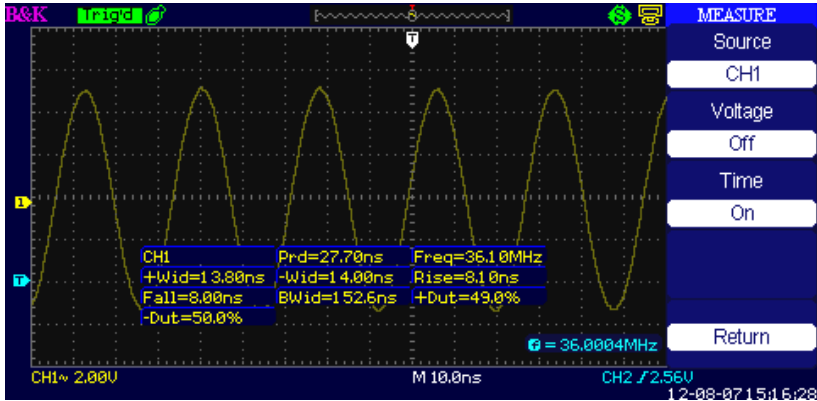

Figure 52 - Measuring Time Parameters

Storage System

Shown below, the “SAVE/RECALL” button enters the “Storage System Function Menu”.

The scope can save and recall up to 20 instrument settings and 20 waveforms to its internal memory. There is a USB host port on the front and rear panel of the oscilloscope where you can save setup data, waveform data, waveform interface image, and CSV file to a USB flash drive. Setup data and waveform data that are saved to a USB flash drive can be recalled on the oscilloscope. For picture data and CSV file, a computer must be used to view them.

- Using SAVE/RECALL Screen**
 The SAVE/RECALL screen is divided into functions based on Directories or Files. Directories show option buttons for **New Folder**, **Del Folder**, and **Load**. While File shows option buttons for **New Folder**, **Delete File**, and **Load**.

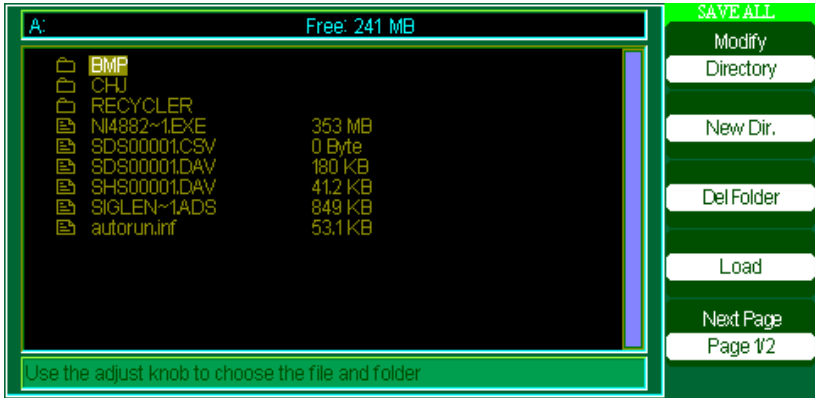

Figure 53 - Save All Menu Screen 1

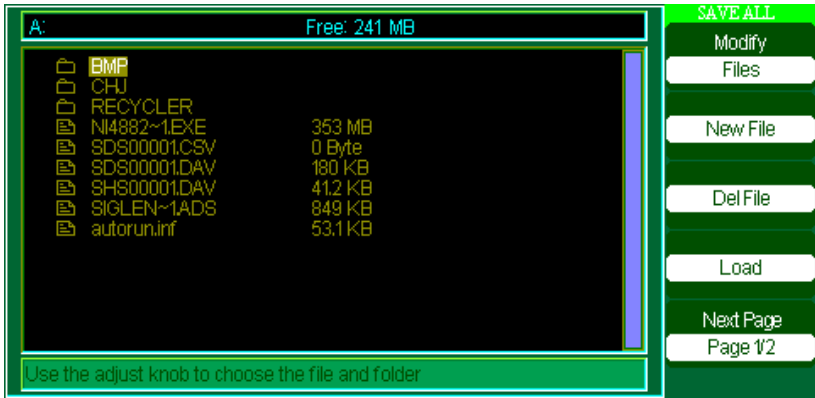

Figure 54 - Save All Menu Screen 2

Recalling Files

The Load button is used to recall your setup files. Once you have navigated to the desired file and it is highlighted in the main screen area, press the Load option button and the setup is recalled from the USB flash drive.

Note: The Load button option is disabled (grayed-out) when .BMP or .CSV file types are selected.

Both Directory and Files have Rename and Return option buttons on Page2/2. Use these buttons to give an existing folder or file a new name or to exit the SAVE/RECALL screen, respectively.

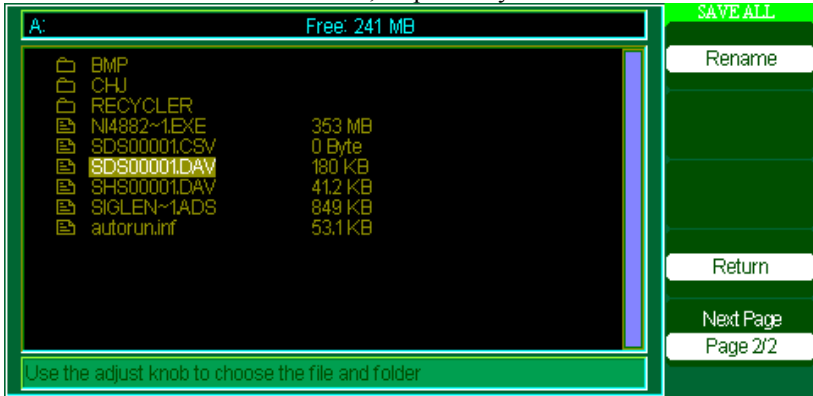

Figure 55 - Rename Screen

Creating Folders and Files

Create new folders and files by pressing the **New Folder** or **New File** option button. The following screen is shown:

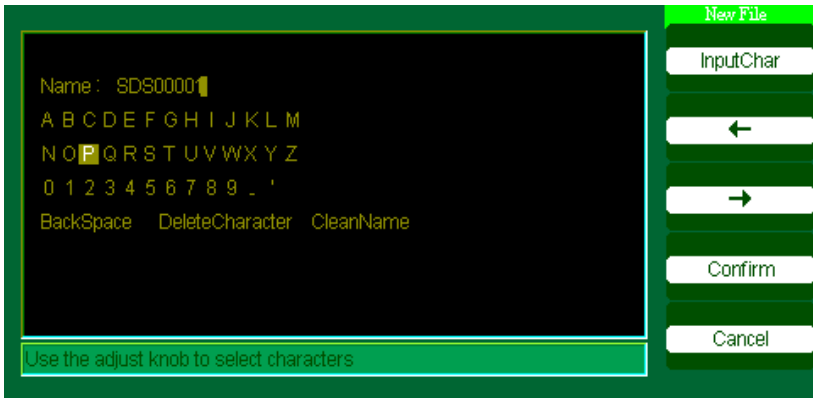

Figure 56 - Input Characters Screen

- The New File menu options are the same as the **New Folder** menu. The InputChar option button adds the selected character to the cursor position in Name field.
- Move the cursor position in the name field using the “→” and “←” option buttons.
- Turn the “Universal” knob to move through character selections. When the desired character is highlighted, press the “Universal” knob or press the “InputChar” option button to add it to the specific position in the Name field.
- Additional selections for BackSpace, DeleteCharacter, and CleanName are available for convenience and are also accessible using the “Universal” knob in the same manner.
- Press the “Confirm” option button (when you have the Name field completed as desired) to save the file onto the memory device. After the “Confirm” option button is pressed, a “Data Store Success!” message is briefly shown and the new folder or file will be listed under your USB flash drive.

Save/Recall Setup

- **Save Setups to Device:** The complete setup is stored in nonvolatile memory. When you recall the setup, the oscilloscope will be in the mode from which the setup was saved. The oscilloscope saves the current setup if you wait three seconds after the last change before you power off the oscilloscope. The oscilloscope recalls this setup the next time you apply power.

Table 42 - Save Setup to Device Function Menu

Option	Setting	Description
Type	Setups	Menu for the Storage/Recall setting in the oscilloscope
Save to	Device	Save setup to the oscilloscope’s internal memory.
Setup	No.1 to No.20	Press the “Setup” option button or turn the “universal” knob to select storage location.
Save		Save to the selected storage location.
Recall		Recall from the storage location indicated by “Setup”.

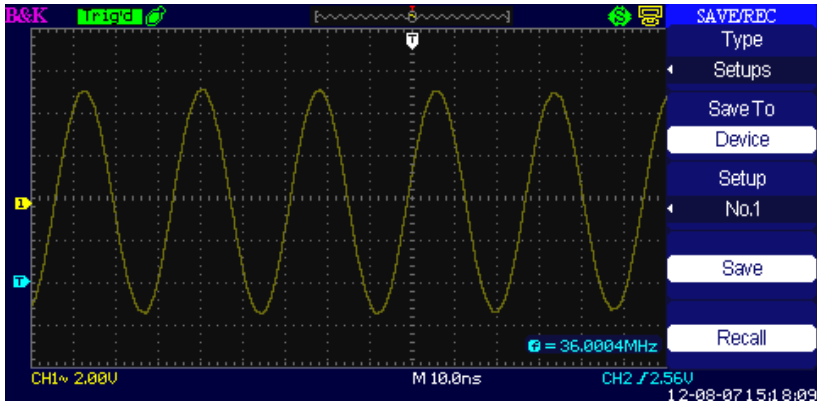

Figure 57 - Save/Rec Menu

To save setups to the oscilloscope’s internal memory, follow the steps below:

For example: Save setup that set waveform display type to “Dots” to internal memory.

1. Press the “SAVE/RECALL” button to enter the “SAVE/RECALL” menu.
2. Press the “Type” option button to select “setups”.
3. Press the “Save to” option button to select “Device”.
4. Press the “Setup” option button to select “No.1”.
5. Press the “DISPLAY” button to enter the “Display” menu.
6. Press the “Type” option button to select “Dots”.
7. Press the “SAVE/RECALL” button to enter the “SAVE/RECALL” menu.
8. Press the “Save” option button.

To Recall setup, follow steps below:

1. Press the “SAVE/RECALL” button to enter the “SAVE/RECALL” display menu.
2. Press the “Type” option button to select “Setups”.
3. Press the “Save to” option button to select “Device”.
4. Press the “Setup” option button or turn the “Universal” knob to select “No.1”.
5. Press the “Recall” option button.

- **Save Setup to USB Flash Drive**

Table 43 - Save Setup to USB Flash Drive Function Menu

Option	Setting	Description
Type	Setups	Menu for the Storage/Recall settings.
Save to	File	Save setup data to USB flash drive.
Save		Go to the Save/Recall interface

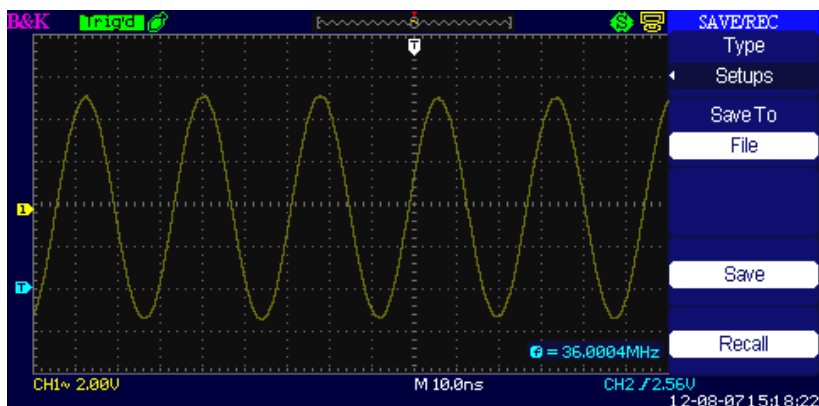

Figure 58 - Save Setup Screen

Save Setup to USB Flash drive:

For example: Save setup that set waveform display type to “Dots” to USB flash drive.

1. Press the “SAVE/RECALL” button to select “Setups”.
2. Insert USB flash drive to USB host port of the oscilloscope and wait until the oscilloscope has initialized USB flash drive (about five second).
3. Press the “Save to” option button to select “file”.
4. Press the “Save” option button to go into the Save/Recall interface.

5. Press the “New folder” button to create a new folder
6. Press the “Del folder” option button to delete a folder
7. Press the “Modify” option button to modify a folder.
8. Press the “New file” option button to create a new file
9. Press the “Del file” option button to delete a file
10. Press “the next page” option button and press the “Rename” option button to modify the name of the file or the folder.
11. Turn the “Universal” knob to select the folder and press the “Confirm” option button and you will save the set to the USB drive.

To Recall setup data from USB flash drive, follow the steps below:

1. Press the “SAVE/RECALL” button.
2. Press the “Type” button to select “Setups”.
3. Insert USB flash drive to USB host port of the oscilloscope and wait until the oscilloscope has initialized USB flash drive (about five seconds).
4. Press the “Save to” option button to select “File”.
5. Press the “Save” option button, then you will go into the Save/Recall interface.
6. Choose the file you want then press the “Load” option button (within 5 seconds there will be a message “Read data success”).
Now the setup data have been recalled from the USB flash drive.

- **Recall Factory**

You can use this option to recall factory settings.

Table 44 - Factory Function Menu

Option	Setting	Description
Type	Factory	To view the Factory setup.
	UpdateCfg	
	Load	Recall the Factory setup.

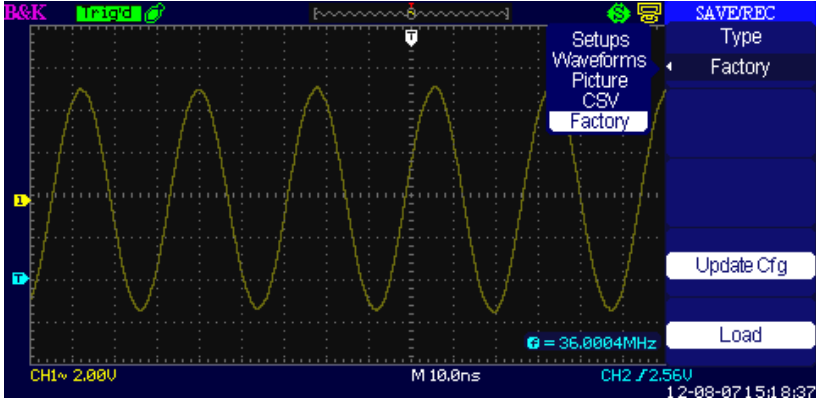

Figure 59 - Set Factory Default Screen

Save/Recall Waveform

Save Waveforms to Device

Table 45 - Save Waveform to Device Function Menu

Option	Setup	Description
Type	Waveforms	Selects Waveform for saving/recalling.
Save to	Device	Save waveforms to the oscilloscope's internal memory.
Waveform	No.1 to No.20	Press the "Waveform" option button or turn the "Universal" knob to select storage location.
Save		Save waveform to the selected storage location.
Recall		Recall the "Waveform" from the selected storage location in "Waveform" option.

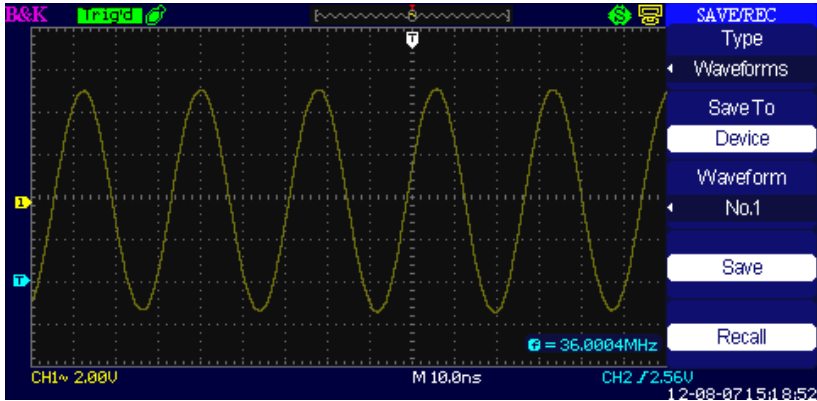

Figure 60 - Save Waveform Menu Screen

To save waveforms in internal memory, follow the steps below:

1. Input a sine signal to channel 1 and press the “Auto” button.
2. Press the “SAVE/RECALL” button to enter “SAVE/RECALL” display menu.
3. Press the “Type” option button to select “Waveforms”.
4. Press the “Save to” option button to select “Device”.
5. Press the “Waveform” option button or turn the “Universal” knob to select “No.1”.
6. Turn the “Volts/div” knob or “Time/div” knob to adjust the waveform that you want.
7. Press the “Save” option button.

To recall waveforms, follow the steps below:

1. Press the “SAVE/RECALL” button to enter “SAVE/RECALL” display menu.
2. Press the “Type” option button to select “Waveforms”.
3. Press the “Save to” option button to select “Device”.
4. Press the “Waveform” option button or turn the “Universal” knob to select “No.1”.
5. Press the “Recall” option button.

Save Waveforms to USB Flash Drive

Table 46 - Save Waveforms to USB Flash Drive Function Menu

Option	Setup	Description
Type	Waveforms	Menu for the Storage/Recall waveforms.
Save to	File	Select save location to USB flash drive.
Save		Select to save to USB.

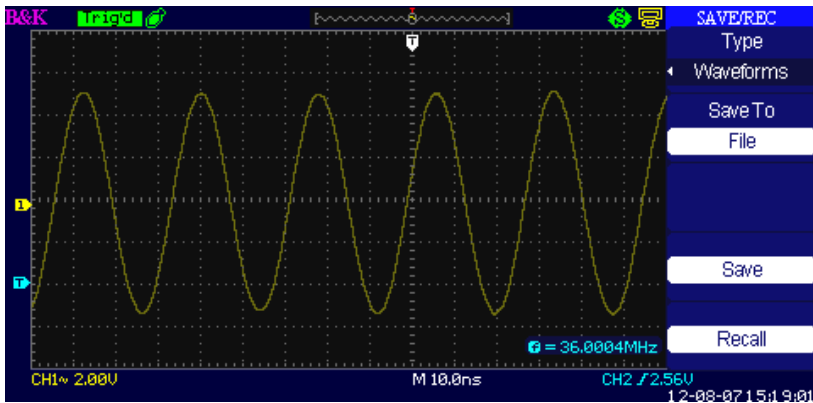

Figure 61 - Save Waveforms Screen

To save waveforms to a USB flash drive, follow the steps below:

1. Input a sine signal to channel 1, press the “AUTO” button.
2. Press the “SAVE/RECALL” button to enter the “SAVE/RECALL” display menu.
3. Press the “Type” option button to select “Waveforms”.
4. Insert a USB flash drive to the front or rear USB host port of the oscilloscope and wait until the oscilloscope has initialized USB flash drive (about five seconds).
5. Press the “Save to” option button to select “File”.
6. Press the “Save” option button then you’ll go into the Save/Recall interface.
7. Create a file then press the “Confirm” button (about five seconds,

there will be a message “Save data success” displayed on the screen). Now the waveform data have been saved to the USB flash drive.

Recall waveforms from USB flash drive, follow next steps:

1. Press the “SAVE/RECALL” button.
2. Press the “Type” button to select “Waveforms”.
3. Insert a USB flash drive to the front or rear USB host port of the oscilloscope and wait until the oscilloscope has initialized USB flash drive (within ten seconds).
4. Press the “Save to” option button to select “File”.
5. Press the “Save” option button then go into the Save/Recall interface.
6. Choose the file you want then press the “Load” option button (about five seconds, there be a message “Recall data success” displayed on the screen). Now the waveform data have been recalled from the USB flash drive.

Save Picture/Screenshot

The display screenshot can be saved to a USB flash drive, but they cannot be recalled. Images can be opened on a computer.

Table 47 - Picture Storage Function Menu

Option	Setting	Description
Type	Picture	Select save screenshot.
Save	/	Saves screenshot to USB flash drive.

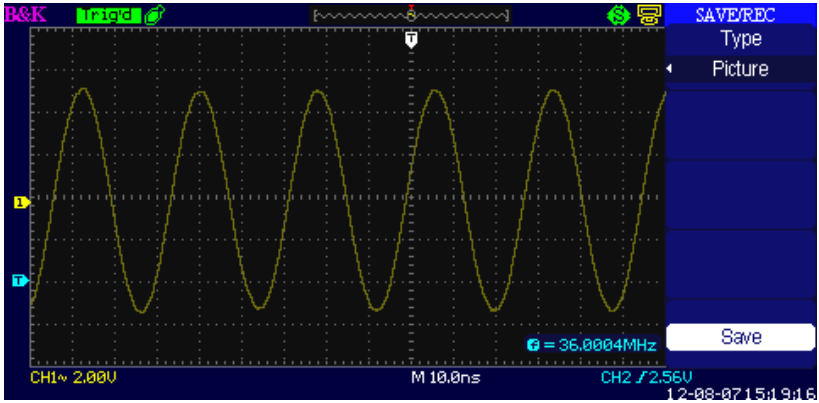

Figure 62 - Save Picture Screen

To save waveform images to USB flash drive, follow the steps below:

1. Select the screen image that you want.
2. Press the “SAVE/RECALL” button to enter “SAVE/RECALL” menu.
3. Press the “Type” option button to select “Picture”.
4. Insert a USB flash drive to the front or rear USB host port of the oscilloscope and wait until the oscilloscope has initialized the USB flash drive (about five seconds).
5. Press the “Print Key” option button to save the screenshot image to the USB flash drive.
6. Alternatively, you can customize the file name to save into by pressing the “Save” option.
7. The “SAVE ALL” menu will display. Select “New File” and enter the filename.
8. Press the “Confirm” button (within five seconds, there will be a message “Save data success” displayed on the screen). Now the screenshot image has been saved to the USB flash drive.

Save/Recall CSV

Table 48 - CSV Storage Function Menu

Option	Setting	Description
Type	CSV	Selects to save waveform data as a

		.CSV file.
Data Depth	Displayed Maximum	Set to store displayed waveform data to .CSV file. Set to store maximum waveform data to .CSV file.
Para Save	On Off	Set whether to include waveform parameters in the .CSV file or not.
Save		Go to the SAVE ALL menu.

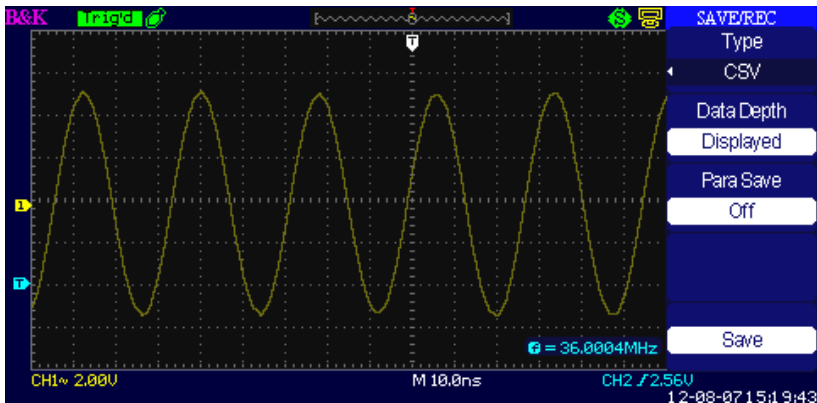

Figure 63 - Save to CSV Screen

To save CSV files to USB flash drive, follow the steps below:

1. Press the “SAVE/RECALL” button to enter “SAVE/RECALL” menu.
2. Press the “Type” option button to select “CSV”.
3. Insert USB flash drive to USB host port of the oscilloscope and wait that the oscilloscope has initialized USB flash drive (about five seconds).
4. Press the “Data Depth” option button to select “Displayed” or “Maximum”.
5. Press the “Para Save” option button to select “On” or “Off”.
6. Press the “Save” option button then you’ll go into the Save/Recall interface
7. Create a file name then press the “Confirm” button (within 5 seconds, there will be a message “Save data success” displayed on the screen). Now the CSV file has been saved to the USB flash drive.

Note: The maximum number of data points of a waveform that can be saved as a .CSV file into USB drive is ~24576 pts (depending on the timebase setting) when data depth is set to maximum. The actual number depends on the time base setting, the channels that are active, and whether data depth is set to “display” or “maximum”. See below table for maximum data points available in each timebase when data depth is set to maximum.

Time base	Number of points saved to CSV file (data depth set to maximum)	
	*Half channel interleaved	Per channel
50 s – 50 ns	12 k	12 k
25 ns – fastest time base	24 k	12 k



*For 4CH models, CH1 and CH2 are interleaved, and CH3 and CH4 are interleaved. “Half channel” operation means only CH1 or CH2 and/or CH3 or CH4 are active. For 2CH models, CH1 and CH2 are interleaved.

Note: 24 k refers to 24756 points, 12 k refers to 12288 points

Utility System

Press the UTILITY button from the front panel to access utility options.

Table 49 - Utility System Function Menu 1

Option	Setting	Description
System Status		Displays summaries of the oscilloscope settings.
Sound	 	Open the key-press voice. Close the key-press voice.
Counter	On Off	Turn on Frequency Counter Turn off Frequency Counter.
Language	English Français 日本語 한국어 Deutsch Español Русский Italiana Português العربية 简体中文 繁體中文	English French Japanese Korean German Spanish Russian Italian Portuguese Arabic Simplified Chinese Traditional Chinese
Next Page	Page 1/4	Press this button to enter second page.

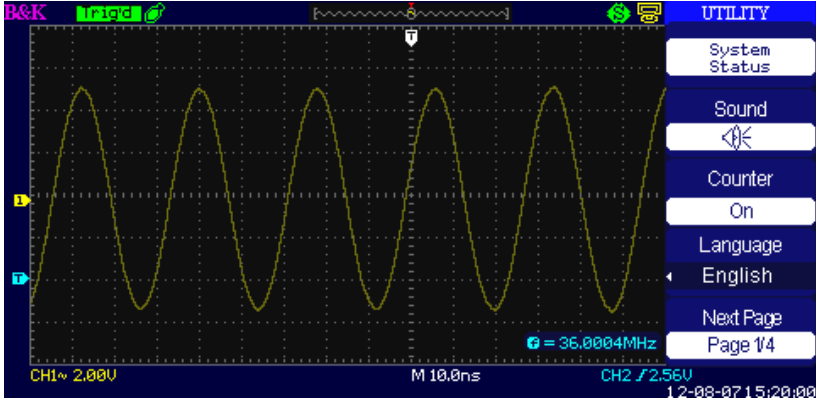

Figure 64 - Utility Menu Screen 1

Table 50 - Utility System Function Menu 2

Option	Setting	Description
Do Self Cal		Auto self calibration.
Do Self Test	Screen Test Keyboard Test LED Test	Run the screen test program Run the keyboard test program Run the LED test program.
Print Setup		Not available.
Back USB	USBTMC	Configures the USB port to USBTMC interface. Use this for remote communication via SCPI.
Next Page	Page 2/4	Press this button to enter third page.

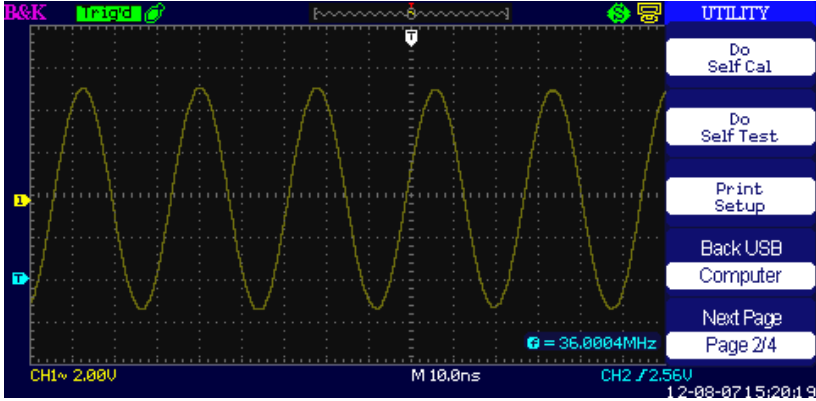

Figure 65 - Utility Menu Screen 2

Table 51 - Utility System Function Menu 3

Option	Setting	Description
Update firmware		Update the firmware of the oscilloscope using a USB flash Drive.
Pass/Fail		Pres this button to enter the “Pass/Fail menu”.
Record		Press this button to enter the waveform record menu.
IP Setting		Press this button to enter the “IP Setting menu” (Currently not used)
Next Page	Page 3/4	Press this button to enter first page.

Table 52 - Utility System Function Menu 4

Option	Setting	Description
Screen saver	1min 2min 5min 10min 15min 30min 1hour 2hour 5hour Off	Sets the timer of the screensaver

Recorder	Record	Goes into the “recorder” menu to start waveform record.
	Replay	Playback recordings
	Option	Recording options
Date/Time		Sets the date and time on the instrument.
Quick-Cal	On Off	Enable or disable quick calibration.
Return		Returns to previous menu

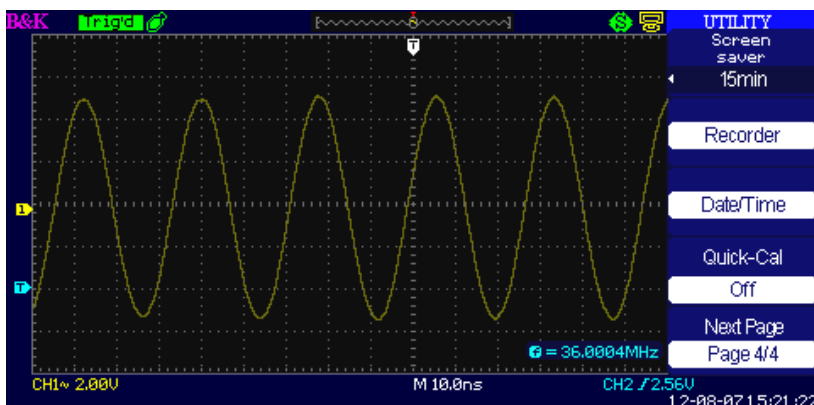

Option	Setting	Description
Year	2000-2099	Set the current display year using the universal knob.
Month/Day	00/00	Set the current display month and day using the universal knob.
Hour/Minute	00/00	Set the current display hour and minute using the universal knob.
Display	ON OFF	Turn on date/time display information. Turn off date/time display information.
Confirm		Press this to confirm the settings.

System Status

Press the “System Status” option button of the Utility Menu to view the oscilloscope’s hardware and software configuration.

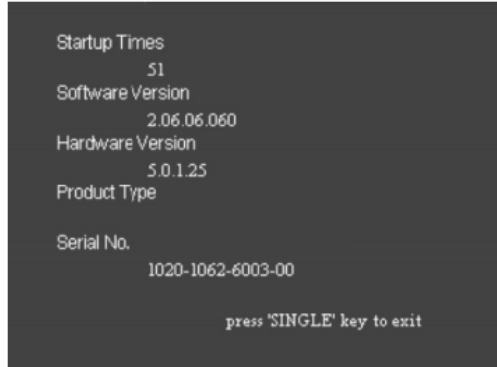

Figure 66 - System Status Info Screen

Table 53 - System Status Information

Option	Description
Startup Times	Lists the number of startup times.
Software Version	Lists the software version.
Hardware Version	Lists the hardware version.
Product Type	Lists the product model.
Serial No.	Lists the product serial number.

Language

Menu items can be displayed in 12 different languages, selectable by the user. .

Press the “UTILITY” button and then select “Language”.

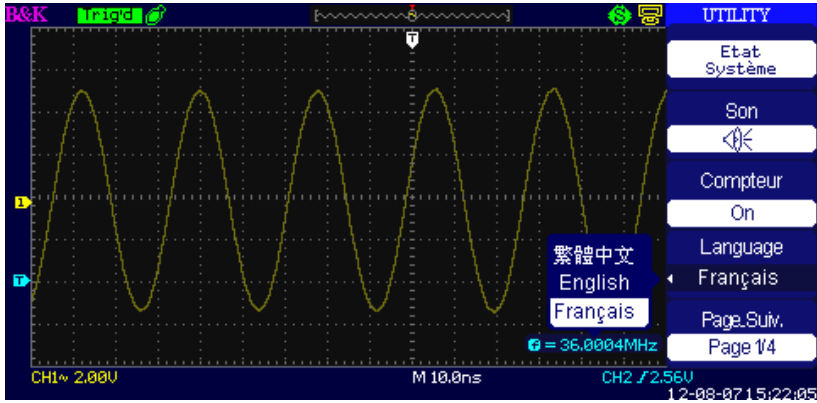

Figure 67 - Language Selection Screen

Self Calibration

Self Calibration procedure can optimize the signal path for optimal measurement results. You can run this procedure at any time. If the operating temperature changes by more than 5° C or the instrument runs more than thirty minutes, running self calibration is recommended. When you run the self Calibration, you must disconnect all the probes and leads, and make sure the scope is not in Single-Shot mode. Then press the “Utility” button to choose the “Do self cal” to show the self Calibration Menu, and execute self calibration program according to the prompt on the screen.

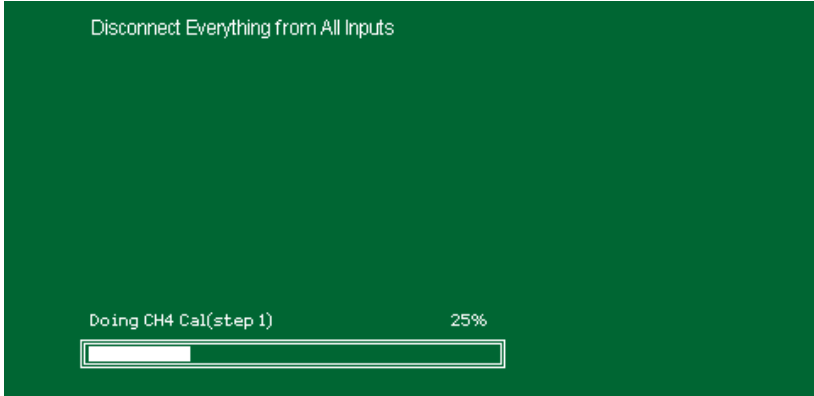

Figure 68 - Calibration Screen

Self Test

Press “UTILITY” and select “Do Self Test”

Table 54 - Self Test Menu

Option	Description
Screen Test	Run Screen Test Program.
Keyboard Test	Run Keyboard Test Program.
LED Test	Run LED Test Program.

Screen Test

Select “Screen Test” to enter the screen test interface. The message “Press ‘SINGLE’ Key to continue, Press ‘RUN/STOP’ Key to exit” is displayed. Press “Single” button to run through the screen color test, or press “Run/Stop” to exit.

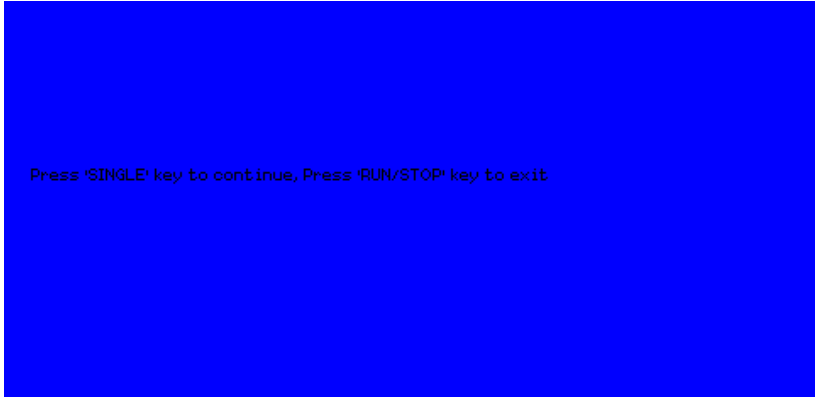

Figure 69- Screen Test Start Screen

Keyboard Test

Select “Keyboard Test” to enter the key test interface. The on-screen shapes represent the front panel keys. The shapes with two arrows beside them represent the front panel knobs. The squares represent the knob presses for scale knobs. Test all keys and knobs to verify that all the backlit buttons illuminate correctly.

Note :

- When you first enter the test, the screen will display all on-screen shapes in white color.
- Pressing any buttons on the front panel will cause its corresponding shape on the display to turn green if it is functioning normally.
- To exit the test at any time, Press ‘ RUN/STOP ’ key three times to exit as indicated at the bottom of the screen.

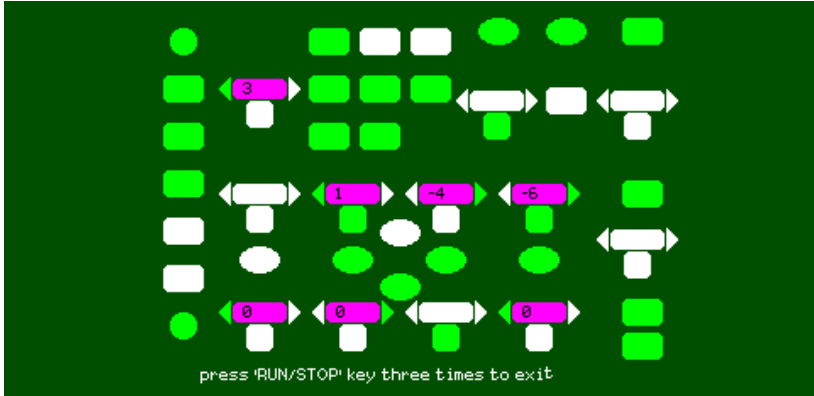

Figure 70 - Key Test Screen

LED Test

Select “LED Test” to test the LED backlights on some of the front panel buttons. The screen will display key shapes that represent all the buttons of the front panel. Follow the instruction prompt below and “Press ‘SINGLE’ Key to continue , Press ‘RUN/STOP’ Key to exit”. Each time “SINGLE” key is pressed, a key shape on the screen will turn green, indicating that the corresponding key or indicator should be lid up. Press “SINGLE” again to test another key backlight. Once all the individual backlit keys are tested, all of them will turn on simultaneously. Pressing “SINGLE” key again will restart all over. To Exit the test, press “RUN/STOP” key.

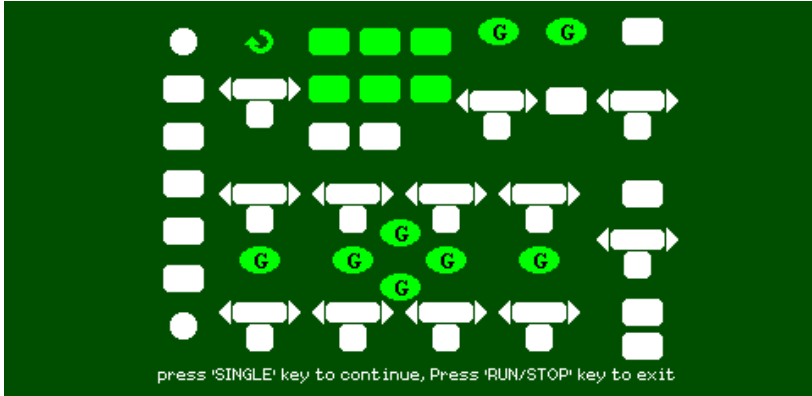

Figure 71 - LED Test Screen

Updating Firmware

- **Using USB flash drive to update firmware**

The firmware of the oscilloscope can be updated directly via a USB Flash drive. This process takes about two minutes. To update, follow the steps below:

1. Download and save the firmware file onto a USB flash drive.
2. Insert the USB Flash Drive to the USB Host interface on the front panel of the oscilloscope.
3. Press the “UTILITY” button to enter the “Utility menu”.
4. Press the “Next Page” option button to enter the third page of the “Utility menu”.
5. Press the “Update Firmware” option button. Read the on-screen notes carefully before proceeding.
6. Press the “SINGLE” button to enter into the directory menu of the USB flash drive.
7. Use the universal knob to select the firmware file on the USB flash drive, and select “Confirm” to start the update.



When completed, turn off the oscilloscope and turn on again. The software will then be updated. The oscilloscope will require self calibration after the update. Go into the utility menu’s second page and select “Do Self Cal” to run self calibration.

WARNING: Do NOT turn off the power while the oscilloscope is updating. Otherwise, the firmware will be corrupted, and the instrument may not be able to reboot again.

Pass/Fail

The Pass/Fail function can monitor changes of signals and output pass or fail signals by monitoring the input signal and checking if it is within the predefined mask or not.

Table 55 - Pass/Fail Function Menu 1

Option	Setting	Description
Enable	On	Turn on Pass/Fail function.
	Off	Turn off Pass/Fail function.
Source	CH1 CH2 CH3 CH4	Select signal input channel.
Operate		Press to run the Pass/Fail test.
		Press to stop the Pass/Fail test.
Msg Display	On Off	Turn on display information of the waveform pass/fail times. Turn off display information of the waveform pass/fail times.
Next Page	Page 1/2	Press this button to enter the second page of Pass/Fail menu.

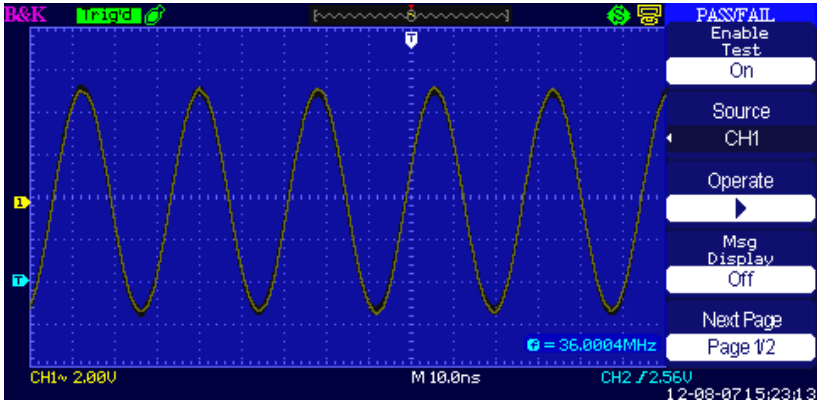

Figure 72 - Pass/Fail Screen 1

Table 56 - Pass/Fail Function Menu 2

Option	Setting	Description
Output	Pass Fail	Output signal when pass condition is detected. Output signal when fail condition is detected.
Stop On Output	On Off	When On, it stops the test when an output occurs. When Off, it continues to test when an output occurs.
Mask Setting		Press this button to enter the “Mask Setting menu”.
Return		Return to the Pass/Fail main menu.
Next Page	Page 2/2	Return the first page of the Pass/Fail menu.

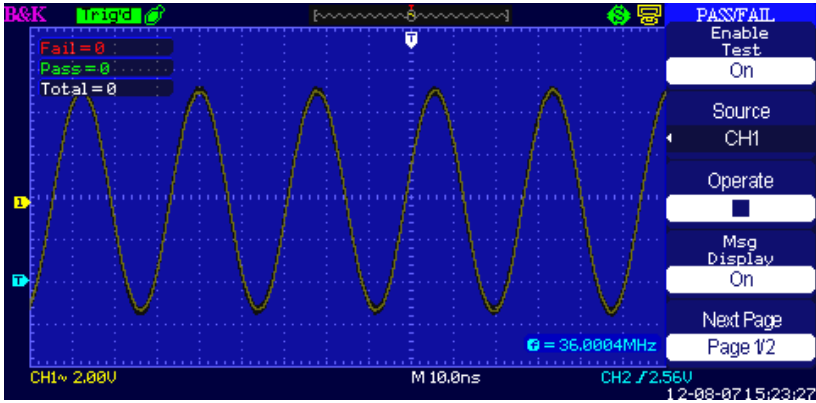

Figure 73 - Pass/Fail Screen 2

Table 57 - Mask Setting Function Menu 1

Option	Setting	Description
X Mask ↻ xdiv		Turn the “Universal” knob to set the range of horizontal clearance to the waveform. <0.04div-4.00div>
Y Mask ↻ ydiv		Turn the “Universal” knob to set the range of vertical clearance to the waveform. <0.04div-4.00div>
Create Mask		Create a test mask according to the above clearance.
Location	Internal External	Select position to store created mask.
Next Page	Page 1/2	Press this button to enter the second page of “Mask Setting menu”.

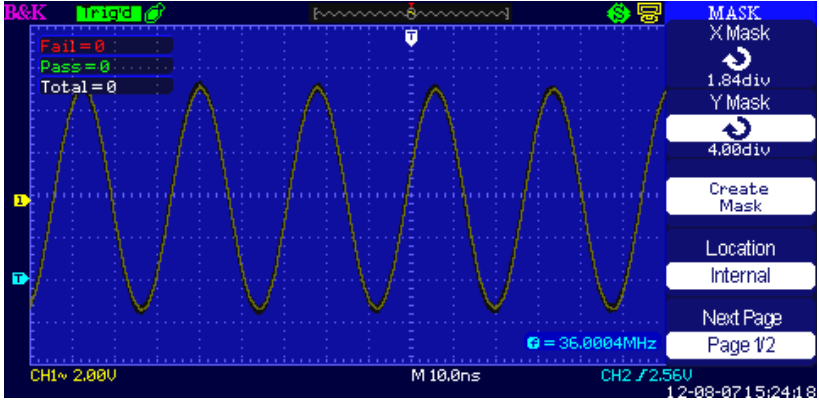

Figure 74 - Mask Menu Screen 1

Table 58 - Mask Setting Function Menu 2

Option	Setting	Description
Save		Store created mask setting.
Load		Recall stored mask setting.
Return		Return to the main menu of mask setting.
Last Page	Page 2/2	Return to the first page of the "Mask Setting menu".

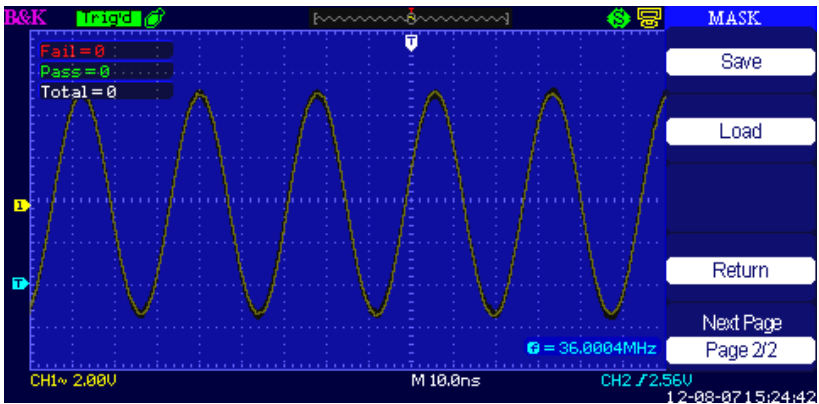

Figure 75 - Mask Menu Screen 2

RUN Pass/Fail test, please follow the steps below:

1. Press UTILITY button to enter the “Utility menu”.
2. Press the “Next Page Page1/4” option button.
1. Press the “Next Page Page2/4” option button to enter the third page of “Utility menu”.
2. Press the “Pass/Fail” option button to enter the “Pass/Fail” function menu.
3. Press the “Enable Test” option button to select “On”.
4. Press the “Source” option button to select input signal channel.
5. Press the “Next Page Page1/2” option button to enter the second page of the “Pass/Fail menu”.
6. Press the “Mask Setting” option button to enter the first page of the “Mask menu”.
7. Press the “X Mask” button; turn the “Universal” knob to adjust the horizontal clearance.
8. Press the “Y Mask” button; turn the “Universal” knob to adjust the vertical clearance.
9. Press the “Create Mask” button to create mask and you can also enter the next page of “Mask menu” to recall the stored mask.
10. Enter the second page of “Pass/Fail function menu”, press the “Output” option button to set the output option.
11. Enter the first page of “Pass/Fail function menu”, press the “Operate” option button to select “▶” to run the pass/fail test.

Waveform Recorder

Press the **Record** option to record the input waveform from CH1, CH2, CH3, or CH4 with a maximum record length of 2500 frames. The time between frames is adjustable. You can record Pass/Fail test output (especially useful when capturing abnormal signals over a long period of time) without having to watch the signal.

Table 59 - Waveform Recorder Function Menu

Option	Setting	Description
---------------	----------------	--------------------

Mode	Record Play Back Storage Off	Set Record function menu. Set Play Back function menu. Set Storage function menu. Turn off waveform recorder menu.
Source	CH1 CH2 *CH3 *CH4 P/F-OUT	Select record source channel.
Interval	↻	Set time interval between record frames.
End Frame	↻	Set max number of record frames.
Operate	● (Record) ■ (Stop)	Press to start recording. Press to stop recording.

*Available for 4CH models only.

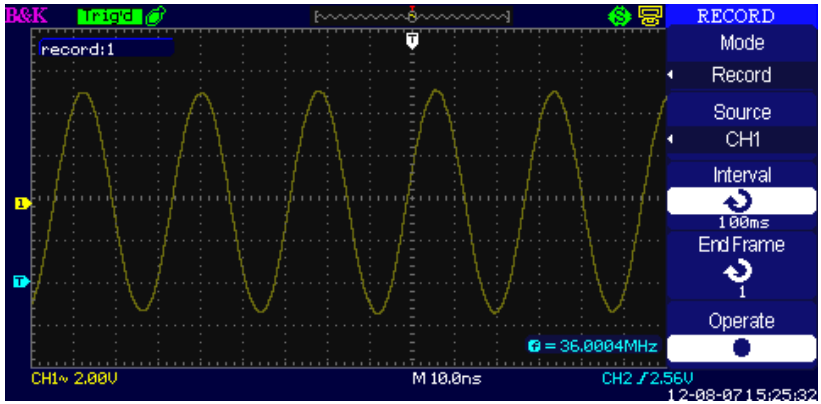





Figure 76 - Record Menu Screen

To record waveforms, follow these steps:

1. Press the UTILITY button to enter “Utility menu”.
2. Press the “Next Page” option button to enter the third page of “Utility menu”.
3. Press the “Record” button to enter “Waveform Record Menu”.
4. Press the “Mode” option button to select “Record”.
5. Press the “Source” option button to select the input signal channel.
6. Select “Interval” option and turn the “Universal” knob to adjust time interval between record frames.
7. Select “End Frame” and turn the “Universal” knob to adjust the max record frame.
8. Press “” in “Operate” option to record waveform.

Play Back: Play back current recorded waveforms or recorded waveforms that have been saved.

Table 60 - Waveform Playback Function Menu 1

Option	Setting	Description
Mode	Play Back	Set the Play Back function menu.
Operate	▶ (Run) ■ (Stop)	Press to start playback. Press to stop playback.
Play Mode	 	Set circular play mode. Set single time play mode.
Interval		Set time interval between frames.
Next Page	Page 1/2	Enter the second page of Play Back menu.

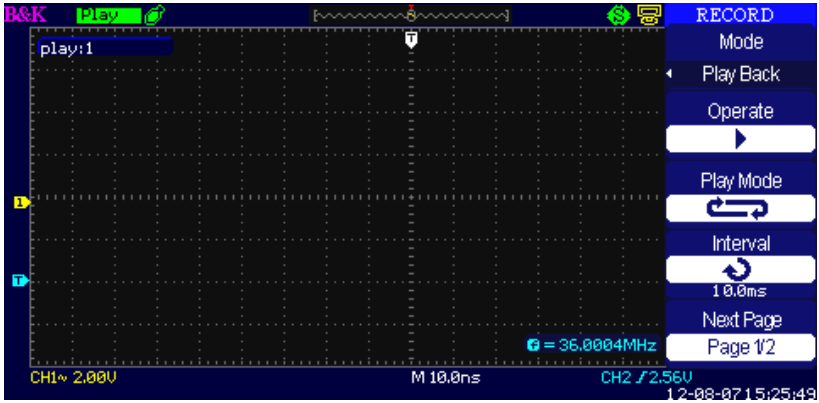





Figure 77 - Record Menu Screen 2

Table 61 - Waveform Playback Function Menu 2

Option	Setting	Description
Start Frame		Set start frame.
Curr_Frame		Select current frame to be played.
End Frame		Set End frame.
Return		Press to return to the waveform recorder main menu.
Next Page	Page 2/2	Return to the first page of Play Back function menu.

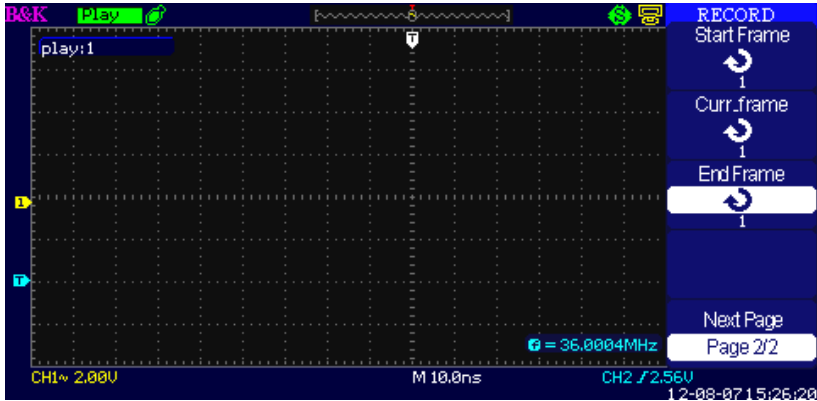





Figure 78 - Record Menu Screen 3

To play back current record waveforms, follow these steps:

1. Press UTILITY button to enter “Utility menu”.
2. Press the “Mode” option button to select “Play Back”.
3. Press the “Play Mode” option button to select “” or “”.
4. Press the “Interval” option button to select time interval between play back frames.
5. Press the “Next Page 1/2” to enter the second page of “Play Back function menu”.
6. Select the “Start Frame” option, turn the “Universal” knob to adjust the start frame of play back waveform.
7. Select the “End Frame” option, turn the “Universal” knob to adjust the end frame of play back waveform.
8. Press the “Next Page 2/2” option button to return the first page of “Play Back menu”.
9. Press the “” option button in “Operate” option to play back waveforms.

Record

This mode allows for gap-free recording of waveform data and can be enabled in SCAN MODE only (refer to “Horizontal Control Knob section”). It is similar to the above described waveform recorder mode, however the recorded data can only be played back on-screen, but cannot be retrieved. Maximum recordable data depends on the timebase in scan mode. Recorded data can also be stored into external USB flash drive.

Table 62 - Waveform Recording Function Menu

Options	Description
Record	Record the waveform persistently
Replay	Replay recorded waveform
Option	Set the recorder properly
Return	Quit the recording function

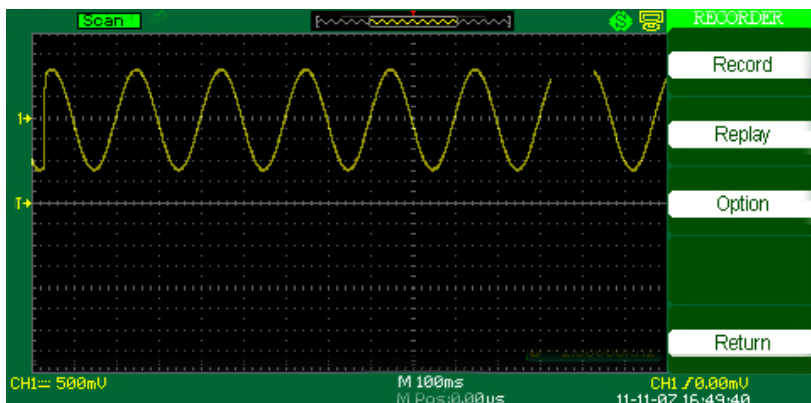

Figure 79 - Record Screen

Options	Setting	Description
Start		Start the recording.
Replay		Replay the recorded waveform
Copy/Filename		When Store Mode is set to USB key, this will show the filename

		used to store the recording.
Store Mode	Memory USB key	Stores recording to internal memory. Stores recording to external USB flash drive.
Return		Return to the Recording Menu.

Option	Description
Continue/Pause	Continue/Pause when playing back a waveform recording.
Restart	Restart the playback of the recorded waveform.
Previous	Recall the waveform recording.
Next	Fast forward play the recalled waveform recording.
Return	Return to the Recording Menu.

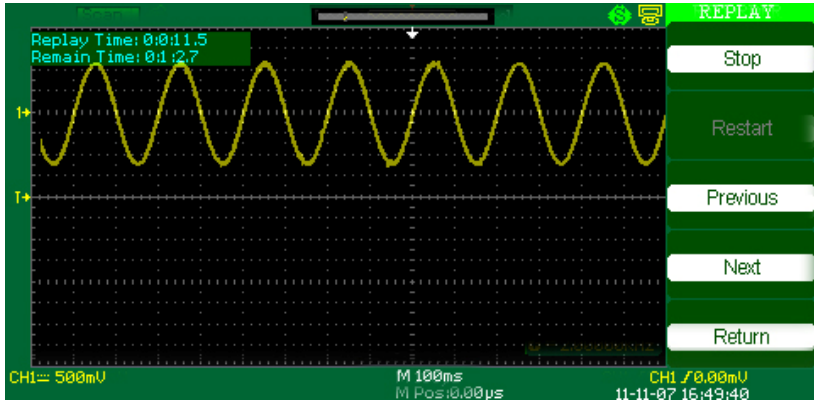

Figure 80 - Replay Screen

Table 63 - Recording Setting Menu

Option	Setting	Description
Viewer	Full Screen	Display full screen of the waveform recording and channel recalling

	Split	Display split screen of the waveform recording and channel recalling, CH1 is displayed in the upper half-screen, and CH2 is displayed in the lower half-screen. For 4CH models, CH1 and CH2 are displayed in the upper half-screen, and CH3 and CH4 are displayed in the lower half-screen.
Record Mode	roll single	Recorder saves the channel waveform persistently, the latter waveform will cover the former. Recorder will stop waveform saving when its memory is full.
Replay Mode	By point By frame	When recalling, the screen waveform refresh from left to right When recalling, screen waveform will refresh completely according to the capturing time of each frame
Return		Exit the Recording Setting Menu.

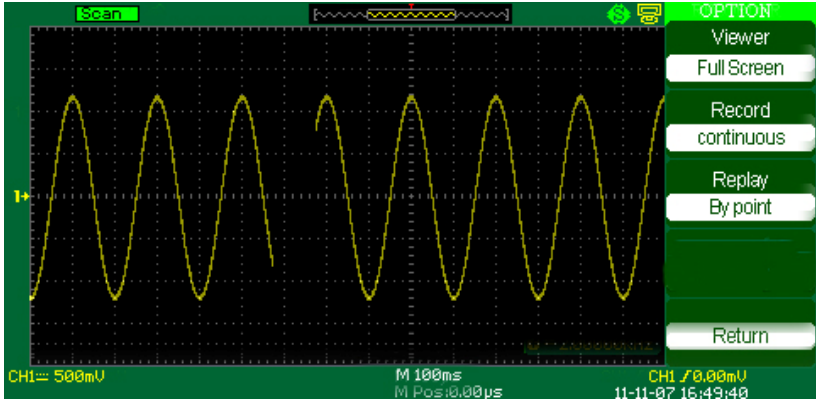

Figure 81 - Option Screen

Recorder Operation step :

1. Press the UTILITY button to enter “Utility” menu.
2. Press the “Next Page” option button to enter the fourth page of “Utility” menu.
3. Press the “Recorder” button to enter the Recorder menu.
4. Press the “Option” button to set Recorder options.
5. Press the “Record” button to enter the Record menu and then press “Start” button to start recording waveform
6. After finished recording waveform, then Press the “Replay” button to view the recorded waveform.

Help Menu

The oscilloscope has help menu to assist users with operating the oscilloscope.

Press the “HELP” button to enter the help status and then press any button to recall the corresponding help information.

All submenus of every main menu have their help information. Note: If you want to see help information of the next page submenus, first press the “HELP” button to exit the help status. Then switch to the next page menu and press the “HELP” button again to enter the help function.



Figure 82 - Help Menu Screen

Chapter 3 Remote Control

The 2550 series digital storage oscilloscope comes with Easyscope application software which provides most of the controls that emulate the front panel of the instrument. The rear panel USB device port is used to connect to a computer to allow for remote communication with the software.

The Easyscope software is free and can be downloaded at www.bkprecision.com

Remote communication commands are also supported via both the USB device interface and the LAN interface. Refer to the programming manual, available for download at www.bkprecision.com.

Chapter 4 Application Examples

This section presents a series of application examples. These simple examples highlight the features of the oscilloscope and give you ideas for using it to solve your own test problems.

- Taking simple measurements
- Capturing a single-shot signal
- Analyzing signal detail
- Triggering on a video signal
- Application of X-Y function
- Analyzing a differential communication signal using math functions

Taking Simple Measurements

Observe an unknown signal in a circuit, display the signal quickly and measure the frequency and peak-to-peak amplitude.

1. Using Auto set

To quickly display a signal, follow these steps:

- Press the CH1 button, set the Probe option attenuation to 10X and set the switch to 10X on the probe.
- Connect the channel 1 probe to the signal.
- Press the AUTO button.
- The oscilloscope sets vertical, horizontal, and trigger controls automatically. If you want to optimize the display of the waveform, you can adjust these controls manually.

NOTE. The oscilloscope displays relevant automatic measurements in the waveform area of the screen based on the signal type detected.

2. Taking Automatic Measurements

The oscilloscope can take automatic measurements of most displayed signals. To measure signal frequency and peak-to-peak amplitude, follow these steps:

Measure signal frequency

1. Input the signal to channel 1.
2. Press the “AUTO” button.
3. Press the “MEASURE” button to see “Auto Measure Menu”.
4. Press the top option button.
5. Press the “Time” option button to enter the “Time Measure menu”.
6. Press the “Source” option button to select input signal channel.
7. Press the “Type” option button to select “Freq”.

The corresponding icon and measure value will display on the third option area.

Measure signal peak-to-peak amplitude

1. Press the “MEASURE” button to display “Auto Measure Menu”.
2. Press the top second option button.
3. Press the “Voltage” option button to enter the “Voltage measure menu”.
4. Press the “Source” option button to select input signal channel.

5. Press the “Type” option button to select “Vpp”.

The corresponding icon and measure value will display on the third option area.

Measuring Ring Frequency

To measure the ring frequency at the rising edge of a signal, follow these steps:

1. Press the “CURSORS” button to see the “Cursor Menu”.
2. Press the “Mode” button to select “Manual”.
3. Press the “Type” option button and select “Time”.
4. Press the “Source” option button and select “CH1”.
5. Press the “Cur A” button and turn the universal knob to place the cursor A on one peak of the ring.
6. Press the “Cur B” button and turn the universal knob to place the cursor B on the nearest peak of the ring.

You can see the delta time and frequency (the measured ring frequency) on the top left of the screen.

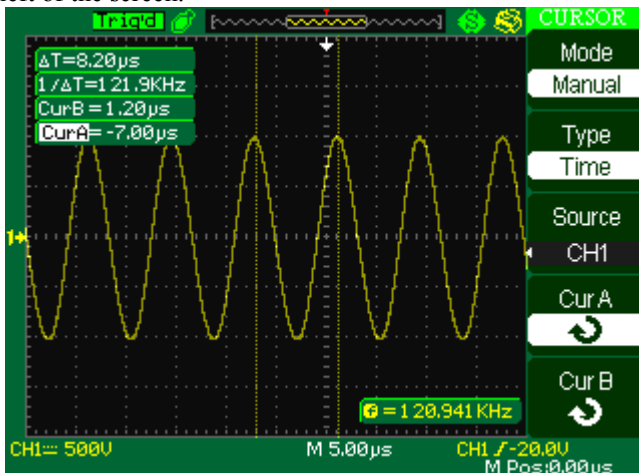

Figure 83 - Cursor Menu Screen 1

Measuring Ring Amplitude

To measure the amplitude, follow these steps:

1. Press the “CURSORS” button to see the Cursor Menu.
2. Press the “Mode” button to select “Manual”.
3. Press the “Type” option button and select “Voltage”.
4. Press the “Source” option button and select “CH1”.
5. Press the “CurA” option button and turn the universal knob to place the cursor A on the highest peak of the ring.
6. Press the “CurB” option button and turn the universal knob to place the cursor B on the lowest peak of the ring.

You can see the following measurements on the top of the left screen:

- The delta voltage (peak-to-peak voltage of the ringing)
- The voltage at Cursor A.
- The voltage at Cursor B.

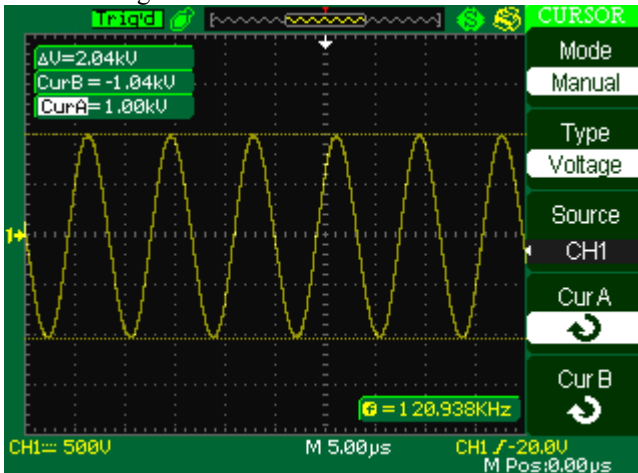

Figure 84 - Cursor Menu Screen 2

Capturing a single event

To capture a single event, you need to gather some knowledge of the signal in order to correctly set up the trigger level and slope. If you are not sure about the instance of the signal, you can observe it through auto or normal trigger mode to ensure the trigger level and slope will capture the signal.

The following steps show you how to use the oscilloscope to capture a single event.

1. Set the Probe option attenuation to 10X and set the switch to 10X on the probe.
2. Trigger set up:
 - 1) Press “TRIG MENU” button to show the “Trigger Menu”
 - 2) Under this menu, set the trigger type to “edge”, Edge type is “Rising”, source is “CH1”, trigger mode is “Single”, coupling is “DC”
 - 3) Adjust the horizontal time base and vertical scale to the satisfied range
 - 4) Turn the “LEVEL” knob to adjust the trigger level
 - 5) Press the “RUN/STOP” button to start capturing

When the trigger conditions are satisfied, data appears on the display representing; the data points that the oscilloscope obtained with one acquisition and press the RUN/STOP button again rearms the trigger circuit and erases the display.

Analyzing Signal Details

You have a noisy signal displayed on the oscilloscope and you need to know more about it. You suspect that the signal contains much more detail than you can now see in the display.

Looking at a Noisy Signal

The signal appears noisy and you suspect that noise is causing problems in your circuit. To analyze the noise better, follow these steps:

- 1) Press the “ACQUIRE” button to see the acquire menu.
- 2) Press the “Acquisition” option button or turn the “Universal” knob to select “Peak Detect”.
- 3) If necessary, press the “DISPLAY” button to see “Display menu”. Turn the “Universal” knob to adjust waveform intensity and grid brightness to see the noise more clearly.
- 4) Peak detect emphasizes noise spikes and glitches in your signal, especially when the time base is set to a slow setting.

Separating the Signal from Noise

To reduce random noise in the oscilloscope display, follow these steps:

- 1) Press the “ACQUIRE” button to display the acquire menu.
- 2) Press the “Acquisition” option button or turn the “Universal” knob to select “Average”.
- 3) Press the “Averages” option button to see the effects of varying the number of running averages on the waveform display.

Averaging reduces random noise and makes it easier to see the details of a signal.

Triggering on a Video Signal

Observe the video circuit in a piece of medical equipment and use the video trigger to obtain a stable display.

Triggering on Video Field

To trigger on the video fields, follow these steps:

- 1) Press the “TRIGGER MENU” button to see “trigger menu”
- 2) Press the top option button and select “Video”.
- 3) Press the “source” option button and select “CH1”.
- 4) Press the “Sync” option button and select “Odd Field” or “Even Field”.
- 5) Press the “Standard” option button and select “NTSC”.
- 6) Turn the horizontal “Time/Div” knob to see a complete field across the screen.
- 7) Turn the vertical “Volts/Div” knob to ensure that the entire video signal is visible on the screen.

Triggering on Video Lines

To trigger on the video lines, follow these steps:

1. Press the “TRIGGER MENU” button to see the trigger menu.
2. Press the top “option” button and select “Video”

3. Press the “Sync” option button and select “Line Num” and turn the universal knob to set a specific line number.
4. Press the “Standard” option button and select “NTSC”.
5. Turn the “Time/Div” knob to see a complete video line across the screen.
6. Turn the “Volts/Div” knob to ensure that the entire video signal is visible on the screen.

Application of X-Y Function

Viewing Impedance Changes in a Network

Connect the oscilloscope to monitor the input and output of the circuit. To view the input and output of the circuit in an XY display, follow these steps:

1. Press the “CH 1” MENU button and set the Probe option attenuation to 10X.
2. Press the “CH 2” MENU button and set the Probe option attenuation to 10X.
3. Set the switch of the probe to 10X.
4. Connect the channel 1 probe to the input of the network, and connect the channel 2 probe to the output.
5. Press the “AUTO” button.
6. Turn the “Volts/div” knobs to display approximately the same amplitude signals on each channel.
7. Press the “DISPLAY” button.
8. Press the Format option button and select “XY”.
9. The oscilloscope displays a Lissajous pattern representing the input and output characteristics of the circuit.
10. Turn the Volts/div and VERTICAL POSITION knobs to optimize the display.
11. Press the “Persist” option button and select “Infinite”.
12. Press the “Intensity” or “Brightness” option buttons and turn the “Universal” knob to adjust the contrast of the screen.

Apply the Ellipse method to observe the phase difference between the two channels

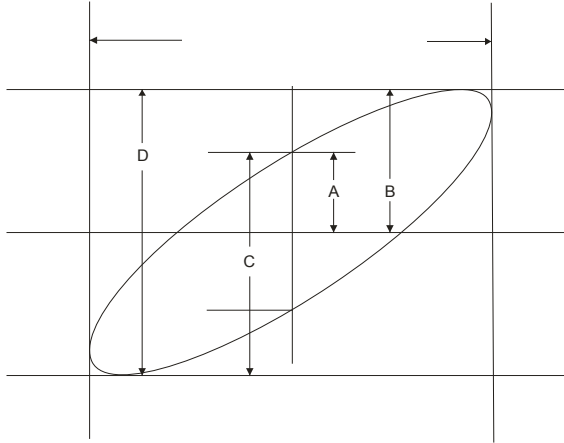

$\sin \theta = A/B$ or C/D where $\theta =$ phase shift (in degrees) between the two signals from the formula above, you could get:

$\theta = \pm \arcsin(A/B)$ or $\pm \arcsin(C/D)$

If the main axis of the ellipse is at II and IV quadrant, θ must be in the range of $(0-\pi/2)$ or $(3\pi/2-2\pi)$. If the main axis is at I and III quadrant, θ must be in the range of $(\pi/2-\pi)$ or $(\pi-3\pi/2)$.

Analyzing a Differential Communication Signal

You are having intermittent problems with a serial data communication link, and you suspect poor signal quality. Set up the oscilloscope to show a snapshot of the serial data stream so you can verify the signal levels and transition times.

Because this is a differential signal, you use the math function of the oscilloscope to view a better representation of the waveform.

To activate the differential signals connected to channel 1 and channel 2, follow these steps:

1. Press the CH 1 button and set the Probe option attenuation to 10X.
2. Press the CH 2 button and set the Probe option attenuation to 10X.
3. Set the switches to 10X on the probes.
4. Press the AUTO button.
5. Press the "MATH" button to see the Math Menu.

6. Press the “Operation” option button and select “—”.
7. Press the “CH1 — CH2” option button to display a new waveform that is the difference between the displayed waveforms.
8. You can adjust the vertical scale and position of the Math waveform. To do so, follow these steps:
 - a. Remove the channel 1 and channel 2 waveforms from the display.
 - b. Turn the CH 1 and CH 2 VOLTS/DIV and VERTICAL POSITION knobs to adjust the vertical scale and position.

NOTE. First be sure to compensate both probes. Differences in probe compensation appear as errors in the differential signal.

Chapter 5 Message Prompts and Troubleshooting

Message Prompts

- **Trig level at limit!** : Prompts you that the trigger Level is at a limit when you turn the Trig level knob.
- **Horizon position at limit!** : Prompts you that the horizontal position is at a limit when you turn the horizontal position knob.
- **Volts/Div at limit!** : Prompts you that the vertical voltage has already reached the Min 2mV/div or the Max 5V/div.
- **Volts position at limit!** : The system would display this information when the vertical position is at a limit.
- **Time/Div at limit!** : Prompts that the Time/Div is at full range while turning the horizontal scale knob.
- **Holdoff time at limit!** : Prompts you that the holdoff time setting has reached max or min value.
- **Function isn't useable!** : Under several special modes, some functions could not be running.
- **No signal!** : The system would display this information when the signal could not match the auto set condition while using the auto set function.
- **Adjust at limit!** : Prompts that the pulse width setting has reached min 20.0 ns or max 10.0 s.
- **Location Empty!** : If you have no stored waveforms or setups at specified location, the screen will display this information when you press the "Recall" button on this location.
- **USB Flash Drive Plug In!** : This information will appear when you insert the USB Flash Drive to the USB Host port.
- **USB Flash Drive Pull Out!** : This information will appear when you pull out the USB Flash Drive from the USB Host port.
- **Store Data Success!** : Saving setup data, waveform data or picture data to the internal memory of the oscilloscope or USB flash was successful.

- **Ready Data Success!** : Read setup data or waveform data from the internal memory of the oscilloscope or USB flash was successful.
- **USB Flash Drive isn't connected!** : When the “Save To” option is set to “File” or the “Print Key” option is set to “Save Picture” in “Save/Recall” menu , press the “Save” option button or the “Time/div” knob before inserting the USB Flash Drive to the USB Host port or this will appear on the screen.
- **Record Wave Success!** : This message will appear when you finish recording waveforms.

Troubleshooting

1. **After the oscilloscope is powered on, the screen remains dark. Please do the following:**
 1. Check the power cable's connection.
 2. Check the rear AC main input switch located above the AC input receptacle. Make sure it is in the ON (|) position.
 3. After the inspecting above, restart the oscilloscope.
2. **If there is no signal wave in the screen after probing DUT for a signal, please do as follows:**
 1. Check whether the probe is connecting with the signal cable or not.
 2. Check whether the signal cable is connected with the BNC connector or not.
 3. Check the probe whether it's connected with the device under test (DUT) or not.
 4. Check the tested DUT to see if it produces the signal or not.
 5. Try to probe the DUT for signal again.
3. **If the value of the tested voltage is 10 times higher or lower than actual, please do the following:**

Check the attenuation quotient whether it matches the probe attenuation proportion or not.
4. **If waveform display is not stable, please do the following:**
 1. Check the signal source on the trigger interface whether or not it matches the signal channel.
 2. Check the trigger mode: normal signal should use the

- “edge” trigger mode. The video signal should use the “Video” Trigger mode. The signal would display steadily only when using matching trigger mode.
3. Attempt to change the “coupling” into “HF Reject” or “LF Reject” display, so that the High/low frequency noise will be filtered.
- 5. When pressing “RUN/STOP” button, nothing displays.**
Check whether or not the trigger mode on the trigger interface is in “normal” or “single”, and then check the trigger level to see if it is over the waveform range. If yes, please move the trigger level to the middle position or set the trigger mode to the “Auto” position. You can also press the “Auto” button to set it up automatically.
- 6. After the Acquisition is set to Averages or Display Persistence time is set too long, the waveform refreshes slowly.**
This is a normal condition for these settings.
- 7. The signal is displayed as a ladder-like waveform.**
1. This phenomenon is normal. The time base may be too slow. Turn the horizontal SCALE knob to increase horizontal resolution to improve the display.
 2. Maybe the display Type is set to “Vectors”. You could set it to Dots mode to improve the display.

Chapter 6 Specifications

- All specifications apply to measurements with a 10X probe. To verify that the oscilloscope meets specifications, the oscilloscope must first meet the following conditions:
 - The oscilloscope must have been operating continuously for thirty minutes within the specified operating temperature.
 - You must perform the Do Self Cal operation, accessible through the Utility menu, if the operating temperature changes by more than 5° C.
 - The oscilloscope must be within the factory calibration interval.
- All specifications are guaranteed unless noted “typical.”

Specifications

	2552/2553	2554/2555	2556/2557	2558/2559
Inputs				
Input Coupling	AC, DC, GND			
Input Impedance	1 MΩ ± 2% 13 pf ± 3 pf		1 MΩ ± 2% 13 pf ± 3 pf 50 Ω ± 2%	
Maximum input voltage	400 V (DC+AC PK-PK, 1 MΩ input impedance, X10), CAT I			
Ch to Ch Isolation (Both channels in same V/div setting)	>100:1 at 35 MHz	>100:1 at 50 MHz	>100:1 at 100 MHz	>100:1 at 150 MHz
Probe attenuator	1X, 10X			
Probe attenuations selectable	1X, 5X, 10X, 50X, 100X, 500X, 1000X			

factors	
---------	--

	2552/2553	2554/2555	2556/2557	2558/2559
Vertical System				
Vertical Sensitivity	2 mV/div – 10 V/div (1-2-5 order)			
Channel voltage offset range	2 mV–100 mV: ±800 mV 102 mV – 5 V: ±40 V			
Vertical Resolution	8 bit			
Channels	2 (2552) 4 (2553)	2 (2554) 4 (2555)	2 (2556) 4 (2557)	2 (2558) 4 (2559)
Analog Bandwidth (-3dB)	70 MHz	100 MHz	200 MHz	300 MHz
Single-shot Bandwidth	70 MHz	100 MHz	200 MHz	300 MHz
Lower frequency limit (AC - 3dB)	≤ 10 Hz (at BNC input)			
DC Gain Accuracy	< ± 3.0%: 5 mV/div to 5 V/div in fixed gain ranges < ± 4.0%: 2 mV/div in variable gain ranges			
DC Measurement Accuracy: All Gain settings ≤100mV/div	± [3%*(reading + offset)+1% * offset +0.2 div+2 mV]			
DC Measurement Accuracy: All Gain settings >100mV/div	± [3%*(reading + offset)+ 1%* offset +0.2 div+100 mV]			
Rise time	< 5 ns	< 3.5 ns	< 1.8 ns	< 1.2 ns

Ch to Ch Skew (both channels in same V/div setting)	<2ns (Equivalent to 2 minor divisions in smallest t/div)	<1ns
Math operation	+, -, *, /, FFT	
FFT	Window mode: Hanning, Hamming, Blackman, Rectangular	
	Sampling points: 1024	
Bandwidth Limited	20 MHz \pm 40% (Note: BW limited below 20 MHz when using probe in x1)	

Common Specifications (all models)

Horizontal System			
Real Time Sampling Rate	*2 GSa/s (half-channel interleaved) 1 GSa/s (per channel) *On 4-Ch models, Ch1 and Ch2 are interleaved, and Ch3 and Ch4 are interleaved. "Half channel" operation means only Ch1 or Ch2 and/or only Ch3 or Ch4 is active.		
Highest Equivalent Sampling Rate	50 GSa/s		
Measure Display Modes	MAIN, WINDOW, WINDOW ZOOM, ROLL, X-Y		
Timebase Accuracy	\pm 100 ppm measured over 1 ms interval		
Horizontal Scan Range	5 ns/div – 50 s/div	2.5 ns/div – 50 s/div	1 ns/div – 50 s/div
	Scan Mode: 100 ms/div – 50 s/div (1-2.5-5 sequence)		
Maximum Memory Length (interleaved)	24,000 points** (12000 points for dual channel operation)		

***The number of data points depends on the timebase setting and whether or not the oscilloscope operates in single or dual channel mode. More

details on the number of data points that can be saved to a CSV file can be found in the storage chapter of this manual. The number of data points that can be captured via USB device interface using the EasyScope software is specified in the EasyScope manual.

Trigger System	
Trigger Types	Edge, Pulse Width, Video, Slope, Alternate
*Trigger Source	CH1, CH2, CH3, CH4, EXT, EXT/5, AC Line
Trigger Modes	Auto, Normal, Single
Trigger Coupling	AC, DC, LF reject, HF reject
*Trigger Level Range	CH1,CH2, CH3, CH4: ± 6 divisions from center of screen
	EXT: ± 1.2 V
	EXT/5: ± 6 V
Trigger Level Accuracy (typical) applicable for the signal of rising and falling time ≥ 20 ns	Internal: $\pm (0.2 \text{ div} \times \text{V/div})$ (within ± 4 divisions from center of screen) EXT: $\pm (6\% \text{ of setting} + 40 \text{ mV})$ EXT/5: $\pm (6\% \text{ of setting} + 200 \text{ mV})$
Trigger Sensitivity	For fixed gain ranges 1 Divisions: DC - 10 MHz 1.5 Divisions: 10 MHz – Ma.x BW
	EXT: 200 mVpp DC-10 MHz, 300 mVpp 10 MHz – Ma.x BW
	EXT/5: 1 Vpp DC-10 MHz, 1.5 Vpp 10 MHz – Max. BW
Pulse Width Trigger	Trigger Modes: (>, <, =) positive Pulse Width, (>, <, =) Negative Pulse Width
	Pulse width range: 20 ns – 10 s
Video Trigger	Support signal formats: PAL/SECAM, NTSC
	Trigger condition : odd field, even field, all lines, line Num

Slope Trigger	(>, <, =) Positive slope, (>, <, =) Negative slope Time: 20 ns - 10 s
Alternate Trigger	CH1 trigger type: Edge, Pulse, Video, Slope
	CH2 trigger type: Edge, Pulse, Video, Slope
	CH3 trigger type: Edge, Pulse, Video, Slope
	CH4 trigger type: Edge, Pulse, Video, Slope

Display System	
Display Mode	Color TFT 7.0 in(177.8 mm) diagonal Liquid Crystal Display
Resolution	480 horizontal by 234 vertical Pixels
Display Color	64K color
Display Contrast (Typical state)	150:1
Backlight Intensity (Typical state)	300 nit
Wave display range	8 x 18 div
Wave Display Mode	Dots, Vector
Persist	Off, 1 sec, 2 sec, 5 sec, Infinite
Menu Display	2 sec, 5 sec, 10 sec, 20 sec, Infinite
Screen-Saver	Off, 1 min, 2 min, 5 min, 10 min, 15 min, 30 min, 1 hour, 2 hour, 5 hour
Waveform interpolation	Sin(x)/x, Linear
Color model	Normal , Invert
Language	English, Arabic, French, German, Russian, Spanish, Portuguese, Japanese, Korean, Italian, Simplified Chinese, Traditional Chinese

X-Y Mode	
X-pole Input / Y-Pole Input	(CH1) / (CH2) or (CH3) / (CH4)
Phase Error	± 3 degrees

Hardware Frequency Counter	
Reading resolution	6 digits
Accuracy	± 0.01%
Range	DC Couple, 10 Hz to Max. BW
Signal Types	Satisfying all trigger signals (except pulse width trigger and video trigger)

Environmental	
Temperature	Operating: 50° F to 104 °F (10 °C to +40 °C) Not operating: -4 °F to 140 °F (-20 °C to +60 °C)
Cooling	Internal cooling fan
Humidity	Operating: 85% RH, 104 °F (40 °C), 24 hours Not operating: 85% RH, 149 °F (65 °C), 24 hours
Elevation	Operating: 9,842.5 ft (3,000m) Nonoperating: 50,085.3 ft (15,266m)

Control Panel Function	
Auto Set	Auto adjusting the Vertical, Horizontal system and Trigger Position
Save/Recall	Save/Recall 20 captured waveforms and 20 setups to/from internal memory or to external USB flash drive.

Power Supply	
Input Voltage	100-240 VAC, CAT II, Auto selection
Frequency Range	45 Hz to 440 Hz
Power	50 VA Max

Mechanical	
Dimensions (WxDxH)	14.1 x 6.14 x 4.65 inches (358 x 156 x 118 mm)
Weight	4CH models: Approx. 9.9 lbs (4.5 kg) 2CH models: Approx. 9.5lbs (4.3 kg)

Interface	
USB	Front and rear panel USB host port for flash drives USB device port: for PC communication
LAN	supports SCPI for remote control

Specifications are subject to change without notice.
 To ensure the most current version of this manual, please download the current version here: <http://www.bkprecision.com/search/manual/255x>
 For current up-to-date product information, please visit www.bkprecision.com

Certification

CE Compliant

CE Declaration of Conformity

The oscilloscope meets the requirements of 2006/95/EC Low Voltage Directive and 2004/108/EC Electromagnet Compatibility Directive.

Low Voltage Directive

- EN61010-1: 2001
Safety requirements for electrical equipment for measurement, control, and laboratory use.

The oscilloscope meets the following:

- Installation Categories II (Supply Connector) and I (Measuring Terminals).
- Pollution Degree 2 (Normally only dry non-conductive pollution occurs. Occasionally a temporary conductivity caused by condensation must be expected.)
- Protection Class I (Provided with terminal for protective ground).
- EN 61010-031: 2002+A1: 2008
Safety requirements for hand-held probe assemblies for electrical measurement and test.

EMC Directive

- EN 61000-3-2: 2006
- EN 61000-3-3: 1995+A1: 2001+A2: 2005
- EN 61326-1: 2006
Electrical equipment for measurement, control, and laboratory use.

Appendix A Default Setup

Menu or system	Options, knobs or buttons	Default setup
CH1,CH2	Coupling	DC
	BW Limit	Off
	Volts/div	Coarse
	Probe	1X
	Invert	Off
	Filter	Off
	Volts/div	1.00V
MATH	Operation	+
	SourceA	CH1
	SourceB	CH1
	Invert	Off
	FFT operation:	
	Source	CH1
	Window	Hanning
	FFT Zoom	1X
	Scale	dBVrms
	Display	Split
HORIZONTAL	Window	Main
	Position	0.00 μ s
	Time/div	500 μ s
	Window Zone	50.0 μ s
	Trigger knob	level
CURSOR	Type	Off
	Source	CH1
	Horizontal (voltage)	+/- 3.2divs
	Vertical (time)	+/- 5divs

MEASURE	Source	CH1
	Type	average
ACQUIRE	three mode options	Sampling
	Averages	16
	Sampling mode	Real Time
DISPLAY	Type	Vectors
	Persist	off
	Gird	
	Intensity	60%
	Brightness	40%
	Format	YT
	Menu Display	infinite
SAVE/RECALL	Type	Setups
	Save To	Device
	Setup	No.1
REF	REFA/REFB	REFA
	Source	CH1
	REFA	off
	REFB	off
UTILITY	Sound	On
	Counter	On
	Back USB	Computer
	Pass/Fail	off
	Record	off
TRIGGER (edge)	Type	edge
	Source	CH1
	Slope	Rising
	Mode	Auto
	Coupling	DC

	LEVEL	0.00V
TRIGGER (pulse)	Type	pulse
	Source	CH1
	When	=
	Set Pulse Width	1.00ms
	Mode	Auto
	Coupling	DC
TRIGGER (Video)	Type	Video
	Source	CH1
	Polarity	Normal
	Sync	All Lines
	Standard	NTSC
	Mode	Auto
TRIGGER (Slope)	Type	Slope
	Source	CH1
	Time	1.00ms
	Mode	Auto
TRIGGER (Alternate)	Type	Alternative
	Source	CH1
	Mode	Edge
	Coupling	DC

Appendix B Index

- Width, 92
- + Width, 91
- Alternative Trigger**, 62
- Auto set, 25
- Blackman, 42
- Counter, 108
- Coupling, 29
- Creating Folders and Files, 96
- DEFAULT SETUP**, 26
- Digital Filter**, 35
- EXT TRIG**, 23
- Fall, 91
- FFT, 39
- Filter, 31
- Hanning, 42
- Keyboard Test, 115
- Language, 108
- Math Functions, 37
- Pass/Fail, 118
- Peak Detect**, 72
- Persist, 76
- Polarity, 56
- Probe Attenuation, 18
- Probe Compensation, 19
- Pulse Trigger**, 53
- Recalling Files, 95
- REF, 45
- Rise, 91
- S/div**, 47
- Sampling**, 71
- Save Picture**, 104
- Screen Test, 114
- Self Calibration, 113
- Self Test, 114
- SET TO 50%**, 22
- Sinx/x, 71
- Slope Trigger**, 59
- Storage, 94
- Sync, 56
- System Status, 111
- Time Domain Aliasing**, 74
- Track Mode, 84
- Trigger, 49
- Trigger status, 13
- Universal Knob, 27
- Updating, 117
- Utility, 107
- Video Trigger**, 55
- Vmax, 90
- Vmin, 90
- Volts/Div**, 33
- Vpp, 90
- Waveform Recorder, 122
- Window, 39
- Window Zone, 48
- X-Y Format, 80

Appendix C Disabling Auto Function

The 2550 series has the ability to disable the Auto button that would automatically setup the scope to display a signal, circumventing the need to know how to set up scope parameters. This feature could be used by educators as a teaching tool for basic oscilloscope operation.

To receive information on how to disable this Auto button function, please contact B&K Precision at http://www.bkprecision.com/contact_us.

SERVICE INFORMATION

Warranty Service: Please go the support and service section on our website www.bkprecision.com to obtain a RMA #. Return the product in the original packaging with proof of purchase to the address below. Clearly state on the RMA the performance problem and return any leads, probes, connectors and accessories that you are using with the device.

Non-Warranty Service: Please go the support and service section on our website www.bkprecision.com to obtain a RMA #. Return the product in the original packaging to the address below. Clearly state on the RMA the performance problem and return any leads, probes, connectors and accessories that you are using with the device. Customers not on an open account must include payment in the form of a money order or credit card. For the most current repair charges please refer to the service and support section on our website.

Return all merchandise to B&K Precision Corp. with pre-paid shipping. The flat-rate repair charge for Non-Warranty Service does not include return shipping. Return shipping to locations in North America is included for Warranty Service. For overnight shipments and non-North American shipping fees please contact B&K Precision Corp.

B&K Precision Corp.
22820 Savi Ranch Parkway
Yorba Linda, CA 92887
www.bkprecision.com
714-921-9095

Include with the returned instrument your complete return shipping address, contact name, phone number and description of problem.

LIMITED THREE-YEAR WARRANTY

B&K Precision Corp. warrants to the original purchaser that its products and the component parts thereof, will be free from defects in workmanship and materials for a period of three years from date of purchase.

B&K Precision Corp. will, without charge, repair or replace, at its option, defective product or component parts. Returned product must be accompanied by proof of the purchase date in the form of a sales receipt.

To help us better serve you, please complete the warranty registration for your new instrument via our website www.bkprecision.com

Exclusions: This warranty does not apply in the event of misuse or abuse of the product or as a result of unauthorized alterations or repairs. The warranty is void if the serial number is altered, defaced or removed.

B&K Precision Corp. shall not be liable for any consequential damages, including without limitation damages resulting from loss of use. Some states do not allow limitations of incidental or consequential damages. So the above limitation or exclusion may not apply to you.

This warranty gives you specific rights and you may have other rights, which vary from state-to-state.

B&K Precision Corp.
22820 Savi Ranch Parkway
Yorba Linda, CA 92887
www.bkprecision.com
714-921-9095

BK PRECISION[®]

22820 Savi Ranch Parkway
Yorba Linda, CA 92887
www.bkprecision.com

© 2012 B&K Precision Corp.