

SMD Power Inductor CDRH127C/A

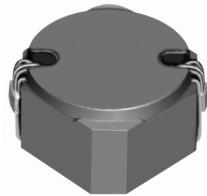

Description

- Ferrite drum core construction.
- Magnetically shielded.
- L × W × H: 12.9 × 12.9 × 8.0 mm Max.
- Product weight: 4.4 g(Ref.)
- Moisture Sensitivity Level: 1
- RoHS compliance.

Environmental Data

- Operating temperature range: -40°C~+125°C (including coil's self temperature rise).
- Storage temperature range: -40°C~+85°C
- Solder reflow temperature: 260 °C peak.

Packaging

- Carrier tape and reel packaging.
- 13.0" diameter reel
- 500pcs per reel

Applications

- Automotive and other high temperature, high reliability application.

Dimension - [mm]

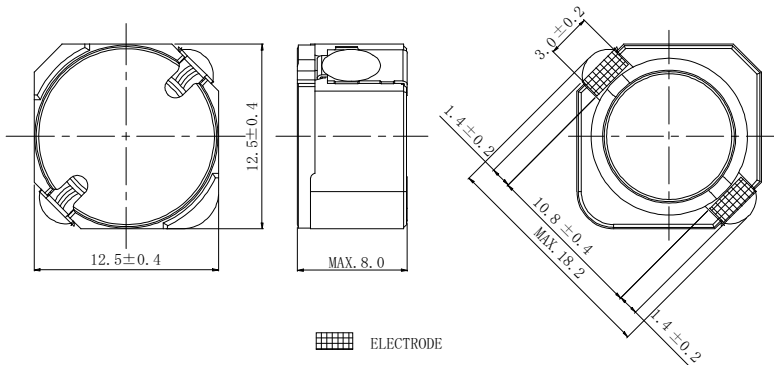

Land pattern and Schematics - [mm]

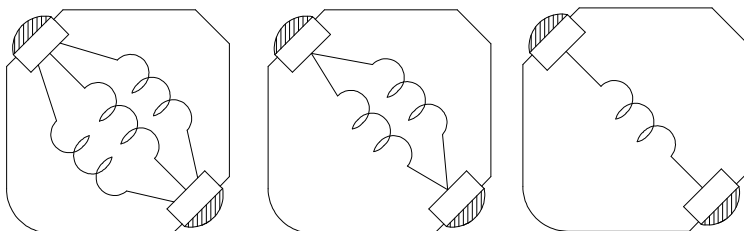
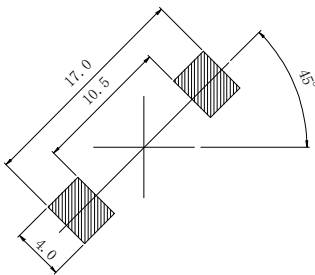

(10 μH ~ 15 μH) (18 μH ~ 100 μH) (120 μH ~ 470 μH)

SMD Power Inductor CDRH127C/A



Electrical Characteristics

Part NO.	Stamp	Inductance [μ H] [Within] ※1	D.C.R. (m Ω) [MAX.] (Typ.) (at 20°C)	Rated current (at 125°C) (A) ※2
CDRH127C/ANP-100MC	100	10 μ H \pm 20%	16.8(13.4)	4.6
CDRH127C/ANP-120MC	120	12 μ H \pm 20%	18.7(14.9)	4.3
CDRH127C/ANP-150MC	150	15 μ H \pm 20%	20.5(16.4)	4.1
CDRH127C/ANP-180MC	180	18 μ H \pm 20%	25.4(20.3)	3.5
CDRH127C/ANP-220MC	220	22 μ H \pm 20%	30.0(23.8)	3.3
CDRH127C/ANP-270MC	270	27 μ H \pm 20%	32.0(25.6)	3.2
CDRH127C/ANP-330MC	330	33 μ H \pm 20%	46.0(36.8)	2.5
CDRH127C/ANP-390MC	390	39 μ H \pm 20%	57.4(45.9)	2.2
CDRH127C/ANP-470MC	470	47 μ H \pm 20%	64.7(51.7)	2.1
CDRH127C/ANP-560MC	560	56 μ H \pm 20%	80.3(64.2)	1.9
CDRH127C/ANP-680MC	680	68 μ H \pm 20%	88.2(70.5)	1.8
CDRH127C/ANP-820MC	820	82 μ H \pm 20%	123.0(98.4)	1.55
CDRH127C/ANP-101MC	101	100 μ H \pm 20%	139.4(111.5)	1.50
CDRH127C/ANP-121MC	121	120 μ H \pm 20%	174.9(139.9)	1.35
CDRH127C/ANP-151MC	151	150 μ H \pm 20%	200.6(160.5)	1.30
CDRH127C/ANP-181MC	181	180 μ H \pm 20%	218.9(175.1)	1.25
CDRH127C/ANP-221MC	221	220 μ H \pm 20%	315.3(252.2)	1.00
CDRH127C/ANP-271MC	271	270 μ H \pm 20%	354.4(283.5)	0.95
CDRH127C/ANP-331MC	331	330 μ H \pm 20%	501.5(401.2)	0.80
CDRH127C/ANP-391MC	391	390 μ H \pm 20%	554.4(443.5)	0.75
CDRH127C/ANP-471MC	471	470 μ H \pm 20%	620.1(496.1)	0.70

※1. Inductance measuring condition: at 100 kHz.

※2. Rated current: The DC current at which the inductance decreases to 65% of its nominal value or when $\Delta t=30^{\circ}\text{C}$, whichever is lower .

SMD Power Inductor CDRH127C/A



Saturation Current & Temperature Rise Graph

— L (20°C) — L (125°C) — ΔT

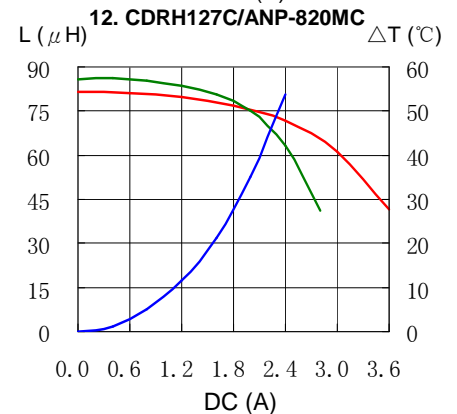
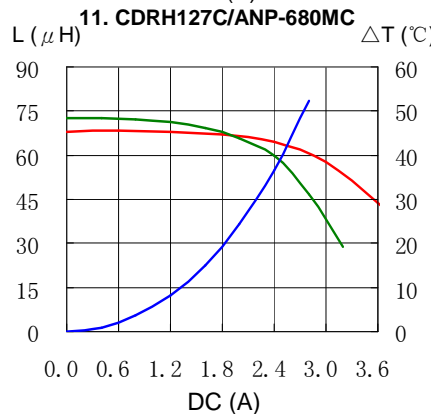
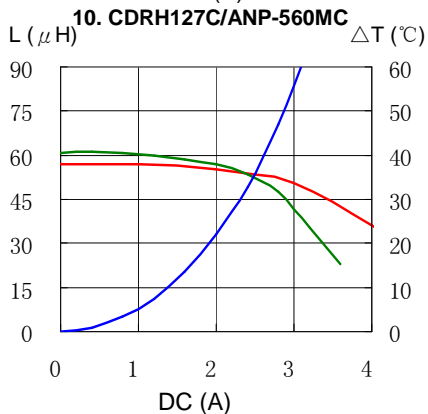
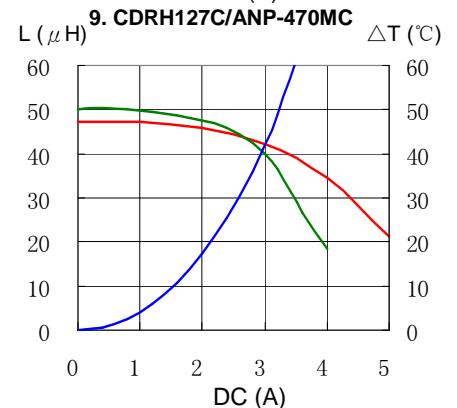
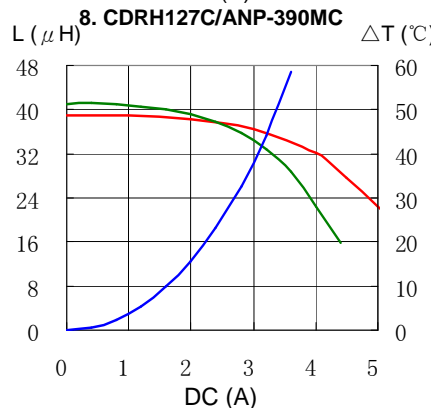
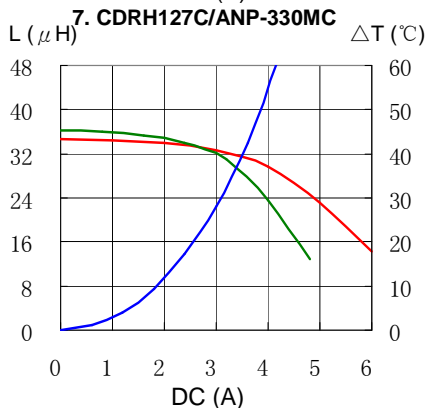
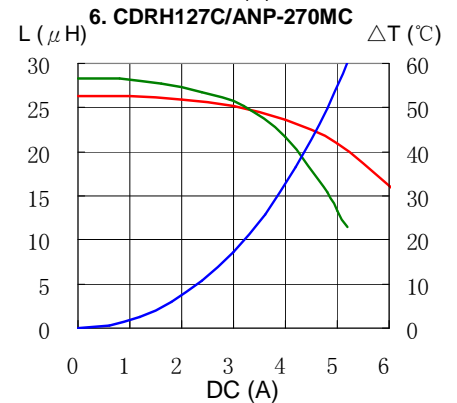
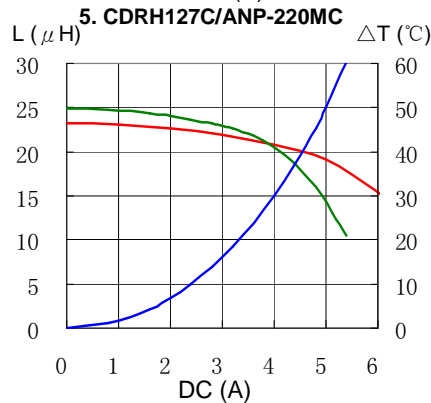
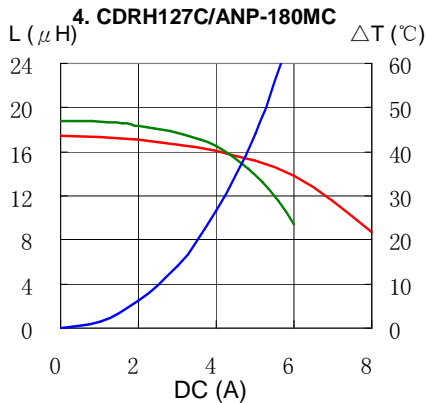
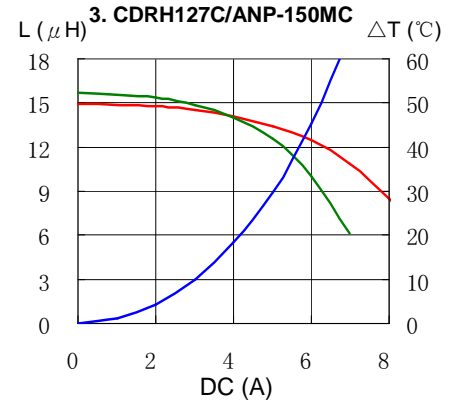
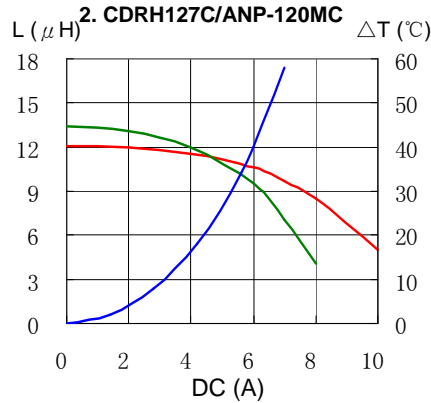
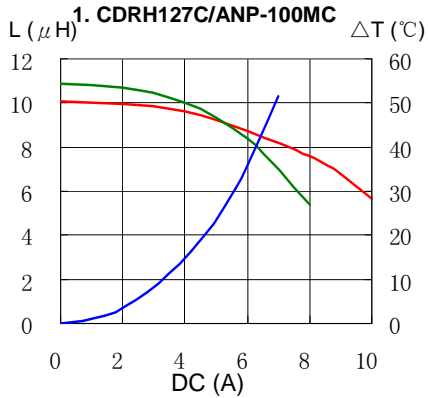

SMD Power Inductor CDRH127C/A



Saturation Current & Temperature Rise Graph

— L (20°C) — L (125°C) — ΔT

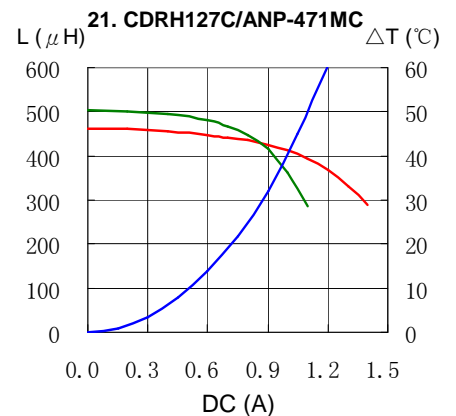
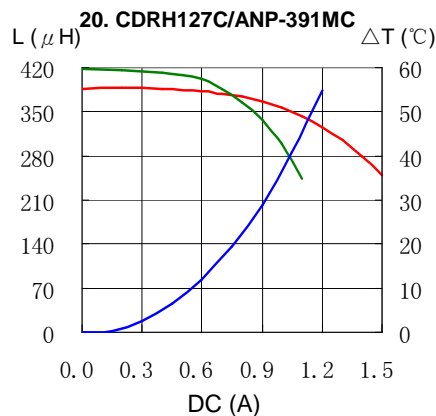
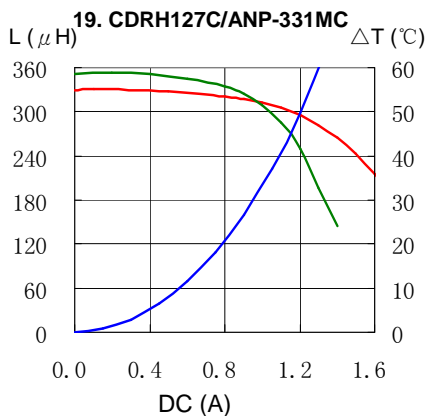
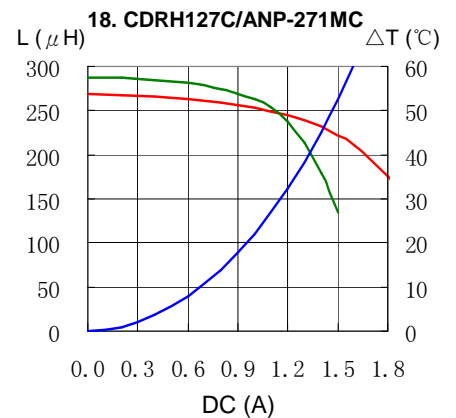
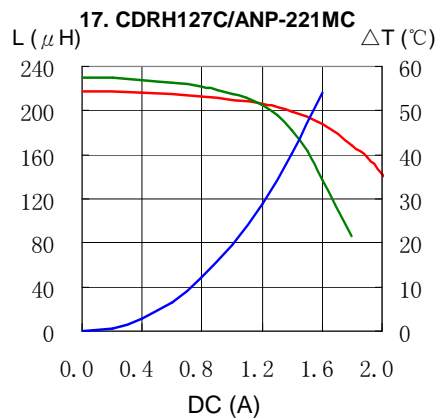
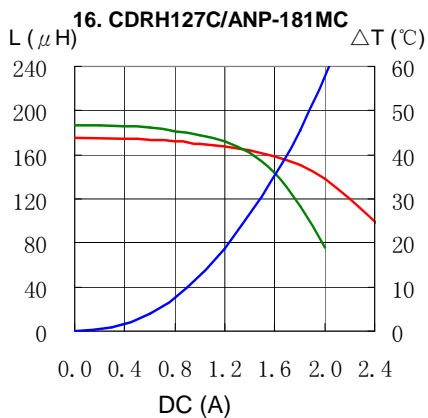
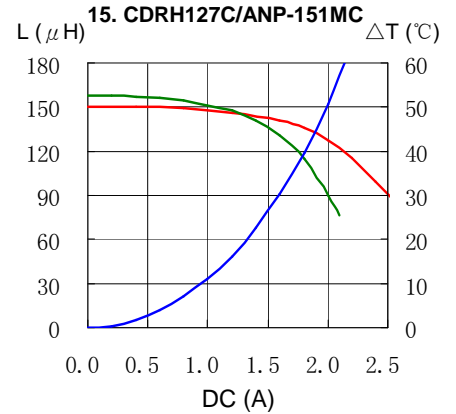
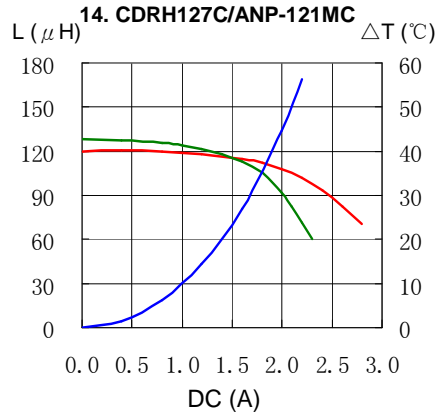
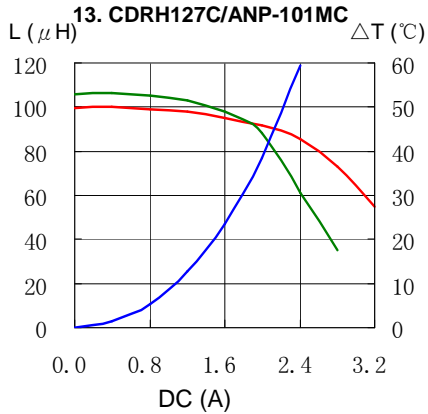

SMD Power Inductor CDRH127C/A



Solder Reflow Condition

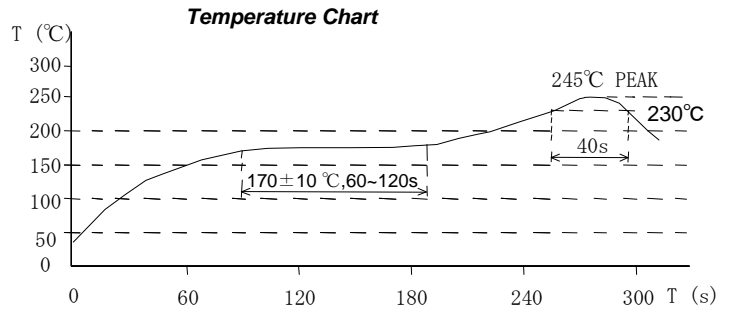
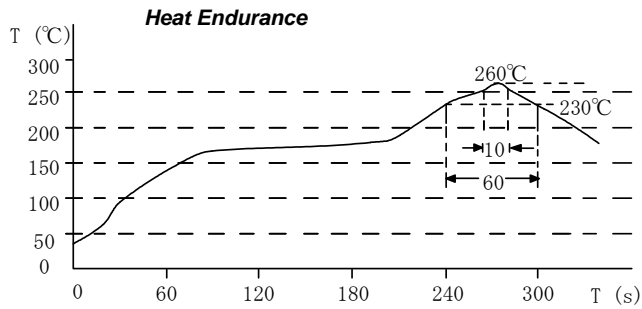

Please refer to the sales offices on our website - <http://www.sumida.com>

Hong Kong

Tel.+852-2880-6781
FAX.+852-2565-9600
sales@hk.sumida.com

Saitama(Japan)

Tel.+81-48-691-7300
FAX.+81-48-691-7340
sales@jp.sumida.com

Chicago

Tel.+1-847-545-6700
FAX. +1-847-545-6720
sales@us.sumida.com

Shanghai

Tel.+86-21-5836-3299
FAX.+86-21-5836-3266
shanghai.sales@cn.sumida.com

Seoul

Tel.+82-2-6237-0777
FAX.+82-2-6237-0778
sales@kr.sumida.com

Oberzell

Tel.+49-8591-937-0
FAX. +49-8591-937-103
contact@eu.sumida.com

Shenzhen

Tel.+86-755-8291-0228
FAX.+86-755-8291-0338
shenzhen.sales@cn.sumida.com

Singapore

Tel.+65-6296-3388
FAX.+65-6841-4426
sales@sg.sumida.com

Neumarkt

Tel.+49-9181-4509-110
FAX. +49-9181-4509-310
infocomp@eu.sumida.com

Taipei

Tel.+886-2-8751-2737
FAX.+886-2-8751-2738
sales@tw.sumida.com

San Jose

Tel.+1-408-321-9660
FAX.+1-408-321-9308
sales@us.sumida.com