

## High Accuracy, Dual Fault, Galvanically Isolated Current Sensor in SOIC16 Wide-Body Package

### FEATURES AND BENEFITS

- Differential current sensing cancels common mode fields, simplifying PCB layout
- Two user-settable faults for fast short-circuit protection and slower overcurrent detection
- Industry-leading noise performance with greatly improved bandwidth through proprietary amplifier and filter design techniques
- Patented integrated digital temperature compensation circuitry allows high accuracy over temperature in an open loop sensor
- 1.0 mΩ primary conductor resistance for low power loss and high inrush current-withstanding capability
- Small footprint, low-profile SOIC16 package suitable for space-constrained applications
- Integrated shield virtually eliminates capacitive coupling from current conductor to die due to high dV/dt voltage transients
- 5 V single supply operation with 0-3 V output swing
- Output voltage proportional to AC or DC current
- Factory-trimmed sensitivity and quiescent output voltage for improved accuracy
- 3600 Vrms Dielectric Strength certified under UL60950-1
- High PSRR for noisy environments

### PACKAGE:

16-Pin SOICW  
(suffix LA)

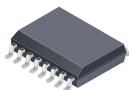

Not to scale

**CB** **US**  
**CB Certificate Number:**  
**US-23711-UL**

### DESCRIPTION

The ACS720 is a high accuracy Hall-effect-based current sensor IC with multiple programmable fault levels intended for industrial and consumer applications with a focus on motor control and power inverter stage applications.

One of the key benefits of the ACS720 is to provide high isolation with a reduced bill of materials made possible by the proprietary IC SOIC16W package. The ACS720 works off of a single 5 V supply while maintaining an output voltage swing from 0 to 3 V, with a stable zero current output of 1.5 V. This allows the ACS720 to operate off of a 5 V supply while having an output which is compatible with typical 3.3 V ADCs found on many MCUs. Furthermore, the ACS720's high PSRR rejects the noise often found on the supplies in the power section of the PCB or system, maintaining high accuracy in noisy environments.

The device has dual fault functions that are user configurable. Fast and slow fault output allow for short-circuit and overcurrent fault detection. A user-created resistor divider from the power supply of the ACS720 is used to set the fault level. The fault outputs are open drain, allowing the user to pull them up to a compatible voltage for the MCU. The open-drain outputs also allow for implementing a simple logical OR of multiple sensor fault outputs.

The ACS720 also integrates differential current sensing, which rejects external magnetic fields, greatly simplifying board layout in 3-phase motor applications.

*Continued on the next page...*

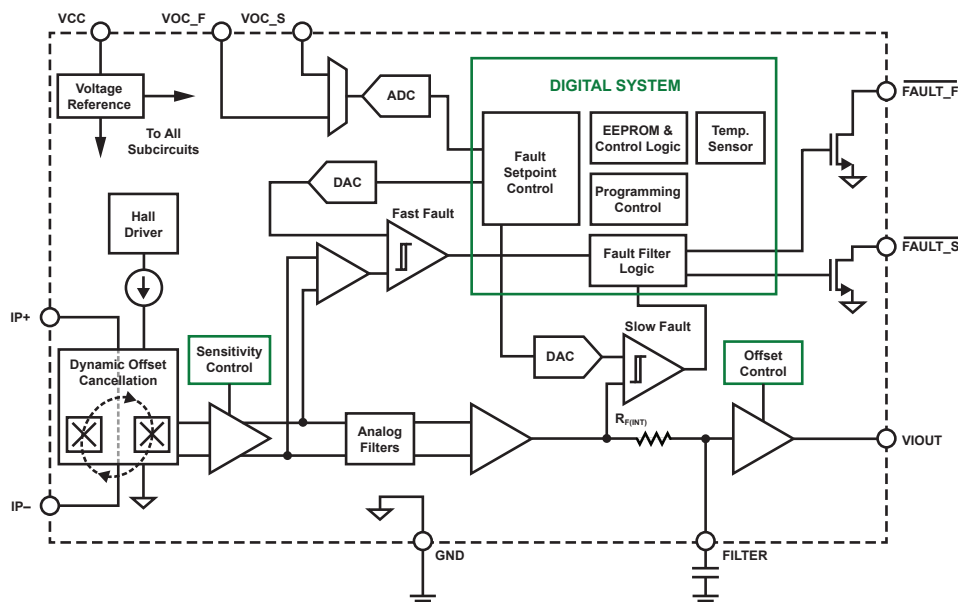

Figure 1: Functional Block Diagram

# ACS720

## High Accuracy, Dual Fault, Galvanically Isolated Current Sensor in SOIC16 Wide-Body Package

### DESCRIPTION (continued)

Near closed-loop accuracy is achieved in this open-loop sensor due to Allegro's patented, digital temperature compensation, ultimately offering a smaller and more economical solution for many current sensing applications that traditionally rely on closed-loop core based sensors.

The ACS720 is provided in a small surface-mount SOIC16 package. The leadframe is plated with 100% matte tin, which is compatible with standard lead (Pb) free printed circuit board assembly processes. Internally, the device is Pb-free, except for flip-chip high-temperature Pb-based solder balls, currently exempt from RoHS. The device is fully calibrated prior to shipment from the factory.

### SELECTION GUIDE

Part Number	Sensing Range, $I_{PR}$ (A)	Sensitivity, Sens (Typ) (mV/A)	$T_A$ (°C)	Packing*
ACS720KLATR-15AB-T	±15	90	-40 to 125	Tape and Reel, 1000 pieces per reel
ACS720KLATR-35AB-T	±35	38.5		
ACS720KLATR-65AB-T	±65	20.5		
ACS720KLATR-80AB-T	±80	16		

\*Contact Allegro for packing options.

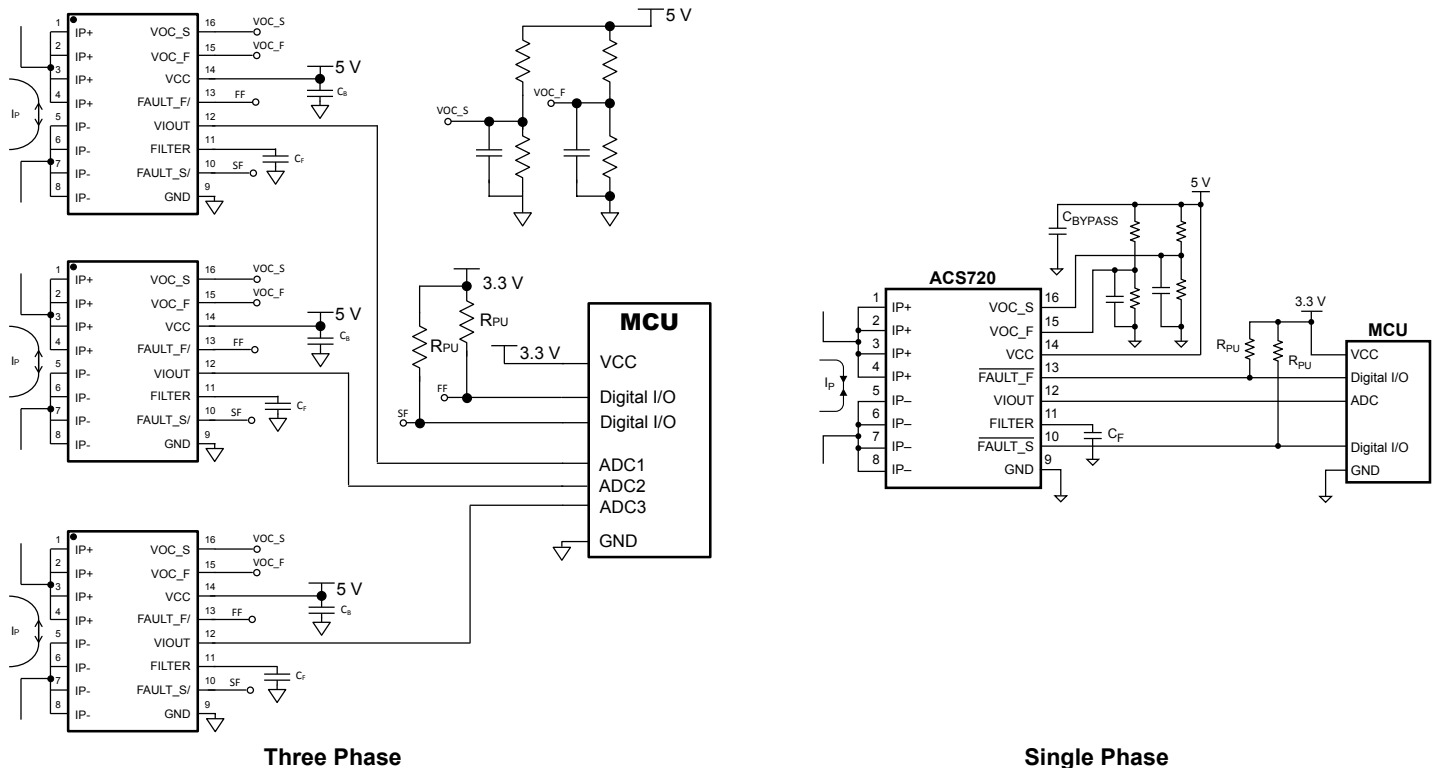

Figure 2: Typical Applications

### ABSOLUTE MAXIMUM RATINGS

Characteristic	Symbol	Notes	Rating	Units
Supply Voltage	$V_{CC}$		6	V
Reverse Supply Voltage	$V_{RCC}$		-0.5	V
Filter Voltage	$V_{FILTER}$		25	V
Reverse Filter Voltage	$V_{RFILTER}$		-0.5	V
Output Voltages	$V_{IOUT}$ , $V_{FAULT\_S}$ , $V_{FAULT\_F}$		$V_{CC} + 0.7$	V
Reverse Output Voltage	$V_{RIOUT}$ , $V_{RFAULT\_S}$ , $V_{RFAULT\_F}$		-0.5	V
Input Pin Voltages	$V_{OC\_S}$ , $V_{OC\_F}$		$V_{CC} + 0.7$	V
Reverse Input Pin Voltages	$V_{ROC\_S}$ , $V_{ROC\_F}$		-0.5	V
Operating Ambient Temperature	$T_A$	Range K	-40 to 125	°C
Junction Temperature	$T_{J(max)}$		165	°C
Storage Temperature	$T_{stg}$		-65 to 170	°C

### ISOLATION CHARACTERISTICS

Characteristic	Symbol	Notes	Value	Units
Dielectric Surge Strength Test Voltage	$V_{SURGE}$	Tested $\pm 5$ pulses at 2/minute in compliance to IEC 61000-4-5 1.2 $\mu s$ (rise) / 50 $\mu s$ (width).	10000	V
Dielectric Strength Test Voltage	$V_{ISO}$	Agency type-tested for 60 seconds per UL 60950-1 (edition 2). Production tested at 2250 $V_{RMS}$ for 1 second in accordance with UL 60950-1.	3600	$V_{RMS}$
Working Voltage for Basic Isolation	$V_{WVBI}$	Maximum approved working voltage for basic (single) isolation according to UL 60950-1 (edition 2).	870	$V_{PK}$ or $V_{DC}$
			616	$V_{RMS}$
Clearance	$D_{cl}$	Minimum distance through air from IP leads to signal leads.	7.5	mm
Creepage	$D_{cr}$	Minimum distance along package body from IP leads to signal leads.	7.5	mm

### PINOUT DIAGRAM

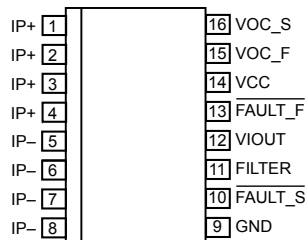

### TERMINAL LIST TABLE

Number	Name	Description
1 through 4	IP+	Terminals for current being sensed; fused internally
5 through 8	IP-	Terminals for current being sensed; fused internally
9	GND	Signal ground terminal
10	FAULT_S	Open drain slow fault output (low true)
11	FILTER	Add capacitor to set output filter pole location
12	VIOUT	Analog output signal
13	FAULT_F	Open drain fast fault output (low true)
14	VCC	Device power supply terminal
15	VOC_F	Sets the trip current level for the fast fault
16	VOC_S	Sets the trip current level for the slow fault

### COMMON OPERATING CHARACTERISTICS [1]: Over full range of $T_A$ , and $V_{CC} = 5\text{ V}$ , unless otherwise specified

Characteristic	Symbol	Test Conditions	Min.	Typ.	Max.	Units
<b>ELECTRICAL CHARACTERISTICS</b>						
Supply Voltage	$V_{CC}$		4.5	5.0	5.5	V
Supply Current	$I_{CC}$	$V_{CC} = 5.0\text{ V}$ , output open	–	13	16	mA
Filter Resistance	$R_{F(INT)}$	$T_A = 25^\circ\text{C}$	–	1.7	–	k $\Omega$
Primary Conductor Resistance	$R_{IP}$	$T_A = 25^\circ\text{C}$	–	1.0	–	m $\Omega$
Power-On Time	$t_{PO}$	Time from when $V_{CC} > V_{CC(min)}$ to when the output reaches 90% of its steady-state level; $T_A = 25^\circ\text{C}$	–	70	–	$\mu\text{s}$
Fault Power-On Time [2]	$t_{PO(FAULT)}$	Time from when $V_{CC} > V_{CC(min)}$ to when FAULT_S and FAULT_F will react to an overcurrent event	–	270	–	$\mu\text{s}$
<b>OUTPUT SIGNAL CHARACTERISTICS</b>						
Rise Time	$t_R$	$T_A = 25^\circ\text{C}$ , $C_L = 1\text{ nF}$ , 1 V step on output	–	3	–	$\mu\text{s}$
Response Time	$t_{RESPONSE}$	$T_A = 25^\circ\text{C}$ , $C_L = 1\text{ nF}$ , 1 V step on output	–	4	–	$\mu\text{s}$
Propagation Delay	$t_{PD}$	$T_A = 25^\circ\text{C}$ , $C_L = 1\text{ nF}$ , 1 V step on output	–	1	–	$\mu\text{s}$
Internal Bandwidth	BW	Small signal –3 dB; $C_L = 1\text{ nF}$	–	120	–	kHz
Output Capacitance Load	$C_L$	VIOUT to GND	–	–	10	nF
Output Resistive Load	$R_L$	VIOUT to GND, VIOUT to VCC	10	–	–	k $\Omega$
Output Source Current	$I_{OUT(SRC)}$	VIOUT shorted to GND	–	3	–	mA
Output Sink Current	$I_{OUT(SNK)}$	VIOUT shorted to VCC	–	30	–	mA
Saturation Voltage	$V_{OL}$	$R_L = 10\text{ k}\Omega$ (VIOUT to VCC)	–	–	150	mV
Clamp Voltage [4]	$V_{CLAMP}$		3.0	3.25	3.5	V
Noise Density	$I_{ND}$	Input-referenced noise density; $T_A = 25^\circ\text{C}$ , $C_L = 4.7\text{ nF}$	–	220	–	$\mu\text{A}/\sqrt{(\text{Hz})}$
Noise	$I_N$	Input referenced noise at 120 kHz bandwidth; $T_A = 25^\circ\text{C}$ ; $C_L = 1\text{ nF}$ ; $C_F = 0\text{ nF}$	–	100	–	$\text{mA}_{\text{rms}}$
		Input referenced noise at 20 kHz bandwidth; $T_A = 25^\circ\text{C}$ ; $C_L = 1\text{ nF}$ ; $C_F = 4.7\text{ nF}$	–	31	–	$\text{mA}_{\text{rms}}$
Nonlinearity	$E_{LIN}$		–	$\pm 0.75$	–	%
Power Supply Rejection Ratio	PSRR	DC to 1 kHz	–	40	–	dB
		1 kHz to 20 kHz	–	30	–	dB
Common Mode Field Rejection Ratio	CMFR	Magnetic field perpendicular to Hall plates	–	–45	–	dB

Continued on the next page...

### COMMON OPERATING CHARACTERISTICS [1] (continued): Over full range of $T_A$ , and $V_{CC} = 5\text{ V}$ , unless otherwise specified

Characteristic	Symbol	Test Conditions	Min.	Typ.	Max.	Units
<b>FAULT CHARACTERISTICS</b>						
Fault Clear Time	$t_{C(F)}$	Time from $I_P$ falling below $I_{FAULT} - I_{HYS}$ to when $V_{FAULT}$ is pulled above $V_{FAULTL}$ ; $R_{PU} = 10\text{ k}\Omega$ , $100\text{ pF}$ from FAULT to ground	–	6	–	$\mu\text{s}$
Fast Fault Hysteresis [3]	$I_{HYS(FF)}$		–	$0.06 \times I_{PR}$	–	A
Slow Fault Hysteresis [3]	$I_{HYS(SF)}$		–	$0.05 \times I_{PR}$	–	A
Fault Output Low Voltage	$V_{FAULTL}$	$R_{PU} = 10\text{ k}\Omega$ , under fault condition, FAULT_S and FAULT_F pins	–	–	0.4	V
Fault Pull-Up Resistance	$R_{PU}$		4.7	–	500	k $\Omega$
Fast Fault Range	$I_{FAULT(F)}$	Absolute value of $I_P$	$1.0 \times I_{PR}$	–	$2.25 \times I_{PR}$	A
Slow Fault Range	$I_{FAULT(S)}$	Absolute value of $I_P$	$0.5 \times I_{PR}$	–	$1.25 \times I_{PR}$	A
VOC Input Range	$V_{VOC}$	VOC_S, VOC_F	$0.3 \times V_{CC}$	–	$0.7 \times V_{CC}$	V
High Impedance Pin Input Current	$I_{IN}$	VOC_S, VOC_F	–	100	–	nA
VOC Sample Rate	$f_{s(VOC)}$	VOC_S, VOC_F	–	62.5	–	kHz
VOC Update Rate	$f_{update(VOC)}$	8 samples averaged per update	–	7.8	–	kHz

[1] Device may be operated at higher primary current levels,  $I_P$ , ambient  $T_A$ , and internal leadframe temperature, provided that the Maximum Junction Temperature,  $T_J(\text{max})$ , is not exceeded.

[2] When  $V_{CC} < V_{CC}(\text{min})$ , the faults remain in the no-fault state.

[3] After the absolute value of  $I_P$  goes above  $I_{FAULT(F)}$  or  $I_{FAULT(S)}$ , tripping the internal fault comparator,  $I_P$  must go below  $I_{FAULT(F)} - I_{HYS(FF)}$  or  $I_{FAULT(S)} - I_{HYS(SF)}$ , before the internal fault comparator will reset.

[4] Clamp Voltage applies only to VIOUT pin.

**x15AB PERFORMANCE CHARACTERISTICS:** Valid at  $T_A = -40^\circ\text{C}$  to  $125^\circ\text{C}$ ,  $V_{CC} = 5\text{ V}$ , unless otherwise specified

Characteristic	Symbol	Test Conditions	Min.	Typ. [1]	Max.	Unit
<b>NOMINAL PERFORMANCE</b>						
Optimized Accuracy Range	$I_{PR}$		-15	-	15	A
Sensitivity	Sens		-	90	-	mV/A
Zero-Current Output Voltage	$V_{IOUT(Q)}$	$I_P = 0\text{ A}$	-	1.5	-	V
Fast Fault Trip Level	$I_{FF(HIGH)}$	$VOC\_F = 0.7 \times V_{CC}$	-	33.8	-	A
	$I_{FF(LOW)}$	$VOC\_F = 0.54 \times V_{CC}$	-	26.3	-	A
Slow Fault Trip Level	$I_{SF(HIGH)}$	$VOC\_S = 0.7 \times V_{CC}$	-	18.8	-	A
	$I_{SF(LOW)}$	$VOC\_S = 0.3 \times V_{CC}$	-	7.5	-	A
<b>TOTAL OUTPUT ERROR COMPONENTS [2] <math>E_{TOT}(I_P) = \{[V_{IOUT\_ideal}(I_P) - V_{IOUT}(I_P)] / [Sens_{ideal}(I_P) \times I_P]\} \times 100</math> (%)</b>						
Total Output Error [3]	$E_{TOT}$	$I_P = I_{PR(max)}$ , $T_A = 25^\circ\text{C}$ to $125^\circ\text{C}$	-1.5	$\pm 0.8$	1.5	%
		$I_P = I_{PR(max)}$ , $T_A = -40^\circ\text{C}$ to $25^\circ\text{C}$	-4	$\pm 1.6$	4	%
Sensitivity Error	$E_{SENS}$	$I_P = I_{PR(max)}$ , $T_A = 25^\circ\text{C}$ to $125^\circ\text{C}$	-1.5	$\pm 0.6$	1.5	%
		$I_P = I_{PR(max)}$ , $T_A = -40^\circ\text{C}$ to $25^\circ\text{C}$	-4	$\pm 1.6$	4	%
Offset Voltage	$V_{OE}$	$I_P = 0\text{ A}$ , $T_A = 25^\circ\text{C}$ to $125^\circ\text{C}$	-10	$\pm 4$	10	mV
		$I_P = 0\text{ A}$ , $T_A = -40^\circ\text{C}$ to $25^\circ\text{C}$	-30	$\pm 9$	30	mV
<b>OVERCURRENT FAULT PERFORMANCE</b>						
Fast Fault Error	$E_{FF(HIGH)+}$	$VOC\_F = 0.7 \times V_{CC}$ , Positive $I_P$ , $T_A = 25^\circ\text{C}$	-10	$\pm 5$	10	%
		$VOC\_F = 0.7 \times V_{CC}$ , Positive $I_P$ , $T_A = 25^\circ\text{C}$ to $125^\circ\text{C}$	-15	$\pm 5$	15	%
		$VOC\_F = 0.7 \times V_{CC}$ , Positive $I_P$ , $T_A = -40^\circ\text{C}$ to $25^\circ\text{C}$	-	$\pm 25$	-	%
	$E_{FF(HIGH)-}$	$VOC\_F = 0.7 \times V_{CC}$ , Negative $I_P$ , $T_A = 25^\circ\text{C}$	-12	$\pm 6$	12	%
		$VOC\_F = 0.7 \times V_{CC}$ , Negative $I_P$ , $T_A = 25^\circ\text{C}$ to $125^\circ\text{C}$	-30	$\pm 20$	30	%
		$VOC\_F = 0.7 \times V_{CC}$ , Negative $I_P$ , $T_A = -40^\circ\text{C}$ to $25^\circ\text{C}$	-	$\pm 35$	-	%
	$E_{FF(LOW)+}$	$VOC\_F = 0.54 \times V_{CC}$ , Positive $I_P$ , $T_A = 25^\circ\text{C}$	-10	$\pm 7$	10	%
		$VOC\_F = 0.54 \times V_{CC}$ , Positive $I_P$ , $T_A = 25^\circ\text{C}$ to $125^\circ\text{C}$	-15	$\pm 10$	15	%
		$VOC\_F = 0.54 \times V_{CC}$ , Positive $I_P$ , $T_A = -40^\circ\text{C}$ to $25^\circ\text{C}$	-	$\pm 25$	-	%
	$E_{FF(LOW)-}$	$VOC\_F = 0.54 \times V_{CC}$ , Negative $I_P$ , $T_A = 25^\circ\text{C}$	-15	$\pm 7$	15	%
		$VOC\_F = 0.54 \times V_{CC}$ , Negative $I_P$ , $T_A = 25^\circ\text{C}$ to $125^\circ\text{C}$	-40	$\pm 25$	40	%
		$VOC\_F = 0.54 \times V_{CC}$ , Negative $I_P$ , $T_A = -40^\circ\text{C}$ to $25^\circ\text{C}$	-	$\pm 45$	-	%
Slow Fault Error	$E_{SF(HIGH)}$	$VOC\_S = 0.7 \times V_{CC}$ , $I_P$ rising	-6	$\pm 3$	6	%
	$E_{SF(LOW)}$	$VOC\_S = 0.3 \times V_{CC}$ , $I_P$ rising	-12	$\pm 5$	12	%
Fast Fault Delay Code	-		0		-	
Slow Fault Delay Code	-		4		-	
<b>FAULT CHARACTERISTICS</b>						
Fast Fault Response Time	$t_{R(FF)}$	Time from $I_P$ rising above $I_{FF}$ until $V_{FAULT\_F} < V_{FAULTL}$ for a current step from 0 to $1.2 \times I_{FAULT(FAST)}$ ; $R_{PU} = 10\text{ k}\Omega$ , 100 pF from $FAULT\_F$ to ground	-	1.5	2	$\mu\text{s}$
Slow Fault Response Time	$t_{R(SF)}$	Time from $I_P$ rising above $I_{SF}$ until $V_{FAULT\_S} < V_{FAULTL}$ for a current step from 0 to $1.2 \times I_{FAULT(SLOW)}$ ; $R_{PU} = 10\text{ k}\Omega$ , 100 pF from $FAULT\_S$ to ground	-	13	-	$\mu\text{s}$

[1] Typical values with +/- are 3 sigma values.

[2] A single part will not have both the maximum/minimum sensitivity error and maximum/minimum offset voltage, as that would violate the maximum/minimum total output error specification. Also, 3 sigma distribution values are combined by taking the square root of the sum of the squares.

[3] Percentage of  $I_P$ , with  $I_P = I_{PR(max)}$ .

**x35AB PERFORMANCE CHARACTERISTICS:** Valid at  $T_A = -40^{\circ}\text{C}$  to  $125^{\circ}\text{C}$ ,  $V_{CC} = 5\text{ V}$ , unless otherwise specified

Characteristic	Symbol	Test Conditions	Min.	Typ. [1]	Max.	Unit
<b>NOMINAL PERFORMANCE</b>						
Optimized Accuracy Range	$I_{PR}$		-35	-	35	A
Sensitivity	Sens		-	38.5	-	mV/A
Zero-Current Output Voltage	$V_{IOUT(Q)}$	$I_P = 0\text{ A}$	-	1.5	-	V
Fast Fault Trip Level	$I_{FF(HIGH)}$	$VOC\_F = 0.7 \times V_{CC}$	-	78.8	-	A
	$I_{FF(LOW)}$	$VOC\_F = 0.38 \times V_{CC}$	-	43.8	-	A
Slow Fault Trip Level	$I_{SF(HIGH)}$	$VOC\_S = 0.7 \times V_{CC}$	-	43.8	-	A
	$I_{SF(LOW)}$	$VOC\_S = 0.3 \times V_{CC}$	-	17.5	-	A
<b>TOTAL OUTPUT ERROR COMPONENTS [2] <math>E_{TOT}(I_P) = \{[V_{IOUT\_ideal}(I_P) - V_{IOUT}(I_P)] / [Sens_{ideal}(I_P) \times I_P]\} \times 100\%</math></b>						
Total Output Error [3]	$E_{TOT}$	$I_P = I_{PR(max)}$ , $T_A = 25^{\circ}\text{C}$ to $125^{\circ}\text{C}$	-1.5	$\pm 0.6$	1.5	%
		$I_P = I_{PR(max)}$ , $T_A = -40^{\circ}\text{C}$ to $25^{\circ}\text{C}$	-4	$\pm 1.5$	4	%
Sensitivity Error	$E_{SENS}$	$I_P = I_{PR(max)}$ , $T_A = 25^{\circ}\text{C}$ to $125^{\circ}\text{C}$	-1.5	$\pm 0.6$	1.5	%
		$I_P = I_{PR(max)}$ , $T_A = -40^{\circ}\text{C}$ to $25^{\circ}\text{C}$	-4	$\pm 1.5$	4	%
Offset Voltage	$V_{OE}$	$I_P = 0\text{ A}$ , $T_A = 25^{\circ}\text{C}$ to $125^{\circ}\text{C}$	-10	$\pm 3.5$	10	mV
		$I_P = 0\text{ A}$ , $T_A = -40^{\circ}\text{C}$ to $25^{\circ}\text{C}$	-30	$\pm 9$	30	mV
<b>OVERCURRENT FAULT PERFORMANCE</b>						
Fast Fault Error	$E_{FF(HIGH)+}$	$VOC\_F = 0.7 \times V_{CC}$ , Positive $I_P$ , $T_A = 25^{\circ}\text{C}$	-10	$\pm 5$	10	%
		$VOC\_F = 0.7 \times V_{CC}$ , Positive $I_P$ , $T_A = 25^{\circ}\text{C}$ to $125^{\circ}\text{C}$	-10	$\pm 5$	10	%
		$VOC\_F = 0.7 \times V_{CC}$ , Positive $I_P$ , $T_A = -40^{\circ}\text{C}$ to $25^{\circ}\text{C}$	-	$\pm 15$	-	%
	$E_{FF(HIGH)-}$	$VOC\_F = 0.7 \times V_{CC}$ , Negative $I_P$ , $T_A = 25^{\circ}\text{C}$	-10	$\pm 5$	10	%
		$VOC\_F = 0.7 \times V_{CC}$ , Negative $I_P$ , $T_A = 25^{\circ}\text{C}$ to $125^{\circ}\text{C}$	-15	$\pm 10$	15	%
		$VOC\_F = 0.7 \times V_{CC}$ , Negative $I_P$ , $T_A = -40^{\circ}\text{C}$ to $25^{\circ}\text{C}$	-	$\pm 20$	-	%
	$E_{FF(LOW)+}$	$VOC\_F = 0.38 \times V_{CC}$ , Positive $I_P$ , $T_A = 25^{\circ}\text{C}$	-20	$\pm 12$	20	%
		$VOC\_F = 0.38 \times V_{CC}$ , Positive $I_P$ , $T_A = 25^{\circ}\text{C}$ to $125^{\circ}\text{C}$	-20	$\pm 12$	20	%
		$VOC\_F = 0.38 \times V_{CC}$ , Positive $I_P$ , $T_A = -40^{\circ}\text{C}$ to $25^{\circ}\text{C}$	-	$\pm 25$	-	%
	$E_{FF(LOW)-}$	$VOC\_F = 0.38 \times V_{CC}$ , Negative $I_P$ , $T_A = 25^{\circ}\text{C}$	-20	$\pm 12$	20	%
		$VOC\_F = 0.38 \times V_{CC}$ , Negative $I_P$ , $T_A = 25^{\circ}\text{C}$ to $125^{\circ}\text{C}$	-30	$\pm 18$	30	%
		$VOC\_F = 0.38 \times V_{CC}$ , Negative $I_P$ , $T_A = -40^{\circ}\text{C}$ to $25^{\circ}\text{C}$	-	$\pm 32$	-	%
Slow Fault Error	$E_{SF(HIGH)}$	$VOC\_S = 0.7 \times V_{CC}$ , $I_P$ rising	-6	$\pm 3$	6	%
	$E_{SF(LOW)}$	$VOC\_S = 0.3 \times V_{CC}$ , $I_P$ rising	-10	$\pm 5$	10	%
Fast Fault Delay Code	-		0			-
Slow Fault Delay Code	-		4			-
<b>FAULT CHARACTERISTICS</b>						
Fast Fault Response Time	$t_{R(FF)}$	Time from $I_P$ rising above $I_{FF}$ until $V_{FAULT\_F} < V_{FAULTL}$ for a current step from 0 to $1.2 \times I_{FAULT(FAST)}$ ; $R_{PU} = 10\text{ k}\Omega$ , 100 pF from $FAULT\_F$ to ground	-	1.5	2	$\mu\text{s}$
Slow Fault Response Time	$t_{R(SF)}$	Time from $I_P$ rising above $I_{SF}$ until $V_{FAULT\_S} < V_{FAULTL}$ for a current step from 0 to $1.2 \times I_{FAULT(SLOW)}$ ; $R_{PU} = 10\text{ k}\Omega$ , 100 pF from $FAULT\_S$ to ground	-	13	-	$\mu\text{s}$

[1] Typical values with +/- are 3 sigma values.

[2] A single part will not have both the maximum/minimum sensitivity error and maximum/minimum offset voltage, as that would violate the maximum/minimum total output error specification. Also, 3 sigma distribution values are combined by taking the square root of the sum of the squares.

[3] Percentage of  $I_P$ , with  $I_P = I_{PR(max)}$ .

**x65AB PERFORMANCE CHARACTERISTICS:** Valid at  $T_A = -40^\circ\text{C}$  to  $125^\circ\text{C}$ ,  $V_{CC} = 5\text{ V}$ , unless otherwise specified

Characteristic	Symbol	Test Conditions	Min.	Typ. [1]	Max.	Unit
<b>NOMINAL PERFORMANCE</b>						
Optimized Accuracy Range	$I_{PR}$		-65	-	65	A
Sensitivity	Sens		-	20.5	-	mV/A
Zero-Current Output Voltage	$V_{IOUT(Q)}$	$I_P = 0\text{ A}$	-	1.5	-	V
Fast Fault Trip Level	$I_{FF(HIGH)}$	$VOC\_F = 0.7 \times V_{CC}$	-	146.3	-	A
	$I_{FF(LOW)}$	$VOC\_F = 0.38 \times V_{CC}$	-	81.3	-	A
Slow Fault Trip Level	$I_{SF(HIGH)}$	$VOC\_S = 0.7 \times V_{CC}$	-	81.3	-	A
	$I_{SF(LOW)}$	$VOC\_S = 0.3 \times V_{CC}$	-	32.5	-	A
<b>TOTAL OUTPUT ERROR COMPONENTS [2] <math>E_{TOT}(I_P) = \{[V_{IOUT\_ideal}(I_P) - V_{IOUT}(I_P)] / [Sens_{ideal}(I_P) \times I_P]\} \times 100 (\%)</math></b>						
Total Output Error [3]	$E_{TOT}$	$I_P = I_{PR(max)}$ , $T_A = 25^\circ\text{C}$ to $125^\circ\text{C}$	-1.5	$\pm 0.6$	1.5	%
		$I_P = I_{PR(max)}$ , $T_A = -40^\circ\text{C}$ to $25^\circ\text{C}$	-4	$\pm 1.5$	4	%
Sensitivity Error	$E_{SENS}$	$I_P = I_{PR(max)}$ , $T_A = 25^\circ\text{C}$ to $125^\circ\text{C}$	-1.5	$\pm 0.5$	1.5	%
		$I_P = I_{PR(max)}$ , $T_A = -40^\circ\text{C}$ to $25^\circ\text{C}$	-4	$\pm 1.5$	4	%
Offset Voltage	$V_{OE}$	$I_P = 0\text{ A}$ , $T_A = 25^\circ\text{C}$ to $125^\circ\text{C}$	-10	$\pm 3.5$	10	mV
		$I_P = 0\text{ A}$ , $T_A = -40^\circ\text{C}$ to $25^\circ\text{C}$	-30	$\pm 9$	30	mV
<b>OVERCURRENT FAULT PERFORMANCE</b>						
Fast Fault Error	$E_{FF(HIGH)+}$	$VOC\_F = 0.7 \times V_{CC}$ , Positive $I_P$ , $T_A = 25^\circ\text{C}$	-10	$\pm 5$	10	%
		$VOC\_F = 0.7 \times V_{CC}$ , Positive $I_P$ , $T_A = 25^\circ\text{C}$ to $125^\circ\text{C}$	-10	$\pm 5$	10	%
		$VOC\_F = 0.7 \times V_{CC}$ , Positive $I_P$ , $T_A = -40^\circ\text{C}$ to $25^\circ\text{C}$	-	$\pm 15$	-	%
	$E_{FF(HIGH)-}$	$VOC\_F = 0.7 \times V_{CC}$ , Negative $I_P$ , $T_A = 25^\circ\text{C}$	-10	$\pm 5$	10	%
		$VOC\_F = 0.7 \times V_{CC}$ , Negative $I_P$ , $T_A = 25^\circ\text{C}$ to $125^\circ\text{C}$	-10	$\pm 5$	10	%
		$VOC\_F = 0.7 \times V_{CC}$ , Negative $I_P$ , $T_A = -40^\circ\text{C}$ to $25^\circ\text{C}$	-	$\pm 15$	-	%
	$E_{FF(LOW)+}$	$VOC\_F = 0.38 \times V_{CC}$ , Positive $I_P$ , $T_A = 25^\circ\text{C}$	-20	$\pm 15$	20	%
		$VOC\_F = 0.38 \times V_{CC}$ , Positive $I_P$ , $T_A = 25^\circ\text{C}$ to $125^\circ\text{C}$	-20	$\pm 15$	20	%
		$VOC\_F = 0.38 \times V_{CC}$ , Positive $I_P$ , $T_A = -40^\circ\text{C}$ to $25^\circ\text{C}$	-	$\pm 25$	-	%
	$E_{FF(LOW)-}$	$VOC\_F = 0.38 \times V_{CC}$ , Negative $I_P$ , $T_A = 25^\circ\text{C}$	-20	$\pm 15$	20	%
		$VOC\_F = 0.38 \times V_{CC}$ , Negative $I_P$ , $T_A = 25^\circ\text{C}$ to $125^\circ\text{C}$	-20	$\pm 15$	20	%
		$VOC\_F = 0.38 \times V_{CC}$ , Negative $I_P$ , $T_A = -40^\circ\text{C}$ to $25^\circ\text{C}$	-	$\pm 30$	-	%
Slow Fault Error	$E_{SF(HIGH)}$	$VOC\_S = 0.7 \times V_{CC}$ , $I_P$ rising	-6	$\pm 3$	6	%
	$E_{SF(LOW)}$	$VOC\_S = 0.3 \times V_{CC}$ , $I_P$ rising	-10	$\pm 5$	10	%
Fast Fault Delay Code	-		0			-
Slow Fault Delay Code	-		4			-
<b>FAULT CHARACTERISTICS</b>						
Fast Fault Response Time	$t_{R(FF)}$	Time from $I_P$ rising above $I_{FF}$ until $V_{FAULT\_F} < V_{FAULTL}$ for a current step from 0 to $1.2 \times I_{FAULT(FAST)}$ ; $R_{PU} = 10\text{ k}\Omega$ , 100 pF from $FAULT\_F$ to ground	-	1.5	2	$\mu\text{s}$
Slow Fault Response Time	$t_{R(SF)}$	Time from $I_P$ rising above $I_{SF}$ until $V_{FAULT\_S} < V_{FAULTL}$ for a current step from 0 to $1.2 \times I_{FAULT(SLOW)}$ ; $R_{PU} = 10\text{ k}\Omega$ , 100 pF from $FAULT\_S$ to ground	-	13	-	$\mu\text{s}$

[1] Typical values with +/- are 3 sigma values.

[2] A single part will not have both the maximum/minimum sensitivity error and maximum/minimum offset voltage, as that would violate the maximum/minimum total output error specification. Also, 3 sigma distribution values are combined by taking the square root of the sum of the squares.

[3] Percentage of  $I_P$ , with  $I_P = I_{PR(max)}$ .



**x80AB PERFORMANCE CHARACTERISTICS:** Valid at  $T_A = -40^{\circ}\text{C}$  to  $125^{\circ}\text{C}$ ,  $V_{CC} = 5\text{ V}$ , unless otherwise specified

Characteristic	Symbol	Test Conditions	Min.	Typ. [1]	Max.	Unit
<b>NOMINAL PERFORMANCE</b>						
Optimized Accuracy Range	$I_{PR}$		-80	-	80	A
Sensitivity	Sens		-	16	-	mV/A
Zero-Current Output Voltage	$V_{IOUT(Q)}$	$I_P = 0\text{ A}$	-	1.5	-	V
Fast Fault Trip Level	$I_{FF(HIGH)}$	$VOC\_F = 0.7 \times V_{CC}$	-	180	-	A
	$I_{FF(LOW)}$	$VOC\_F = 0.38 \times V_{CC}$	-	100	-	A
Slow Fault Trip Level	$I_{SF(HIGH)}$	$VOC\_S = 0.7 \times V_{CC}$	-	100	-	A
	$I_{SF(LOW)}$	$VOC\_S = 0.3 \times V_{CC}$	-	40	-	A
<b>TOTAL OUTPUT ERROR COMPONENTS [2] <math>E_{TOT}(I_P) = \{[V_{IOUT\_ideal}(I_P) - V_{IOUT}(I_P)] / [Sens_{ideal}(I_P) \times I_P]\} \times 100\%</math></b>						
Total Output Error [3]	$E_{TOT}$	$I_P = I_{PR(max)}$ , $T_A = 25^{\circ}\text{C}$ to $125^{\circ}\text{C}$	-1.5	$\pm 0.6$	1.5	%
		$I_P = I_{PR(max)}$ , $T_A = -40^{\circ}\text{C}$ to $25^{\circ}\text{C}$	-4	$\pm 1.5$	4	%
Sensitivity Error	$E_{SENS}$	$I_P = I_{PR(max)}$ , $T_A = 25^{\circ}\text{C}$ to $125^{\circ}\text{C}$	-1.5	$\pm 0.5$	1.5	%
		$I_P = I_{PR(max)}$ , $T_A = -40^{\circ}\text{C}$ to $25^{\circ}\text{C}$	-4	$\pm 1.5$	4	%
Offset Voltage	$V_{OE}$	$I_P = 0\text{ A}$ , $T_A = 25^{\circ}\text{C}$ to $125^{\circ}\text{C}$	-10	$\pm 3.5$	10	mV
		$I_P = 0\text{ A}$ , $T_A = -40^{\circ}\text{C}$ to $25^{\circ}\text{C}$	-30	$\pm 9$	30	mV
<b>OVERCURRENT FAULT PERFORMANCE</b>						
Fast Fault Error	$E_{FF(HIGH)+}$	$VOC\_F = 0.7 \times V_{CC}$ , Positive $I_P$ , $T_A = 25^{\circ}\text{C}$	-10	$\pm 5$	10	%
		$VOC\_F = 0.7 \times V_{CC}$ , Positive $I_P$ , $T_A = 25^{\circ}\text{C}$ to $125^{\circ}\text{C}$	-10	$\pm 5$	10	%
		$VOC\_F = 0.7 \times V_{CC}$ , Positive $I_P$ , $T_A = -40^{\circ}\text{C}$ to $25^{\circ}\text{C}$	-	$\pm 15$	-	%
	$E_{FF(HIGH)-}$	$VOC\_F = 0.7 \times V_{CC}$ , Negative $I_P$ , $T_A = 25^{\circ}\text{C}$	-10	$\pm 5$	10	%
		$VOC\_F = 0.7 \times V_{CC}$ , Negative $I_P$ , $T_A = 25^{\circ}\text{C}$ to $125^{\circ}\text{C}$	-10	$\pm 5$	10	%
		$VOC\_F = 0.7 \times V_{CC}$ , Negative $I_P$ , $T_A = -40^{\circ}\text{C}$ to $25^{\circ}\text{C}$	-	$\pm 15$	-	%
	$E_{FF(LOW)+}$	$VOC\_F = 0.38 \times V_{CC}$ , Positive $I_P$ , $T_A = 25^{\circ}\text{C}$	-20	$\pm 15$	20	%
		$VOC\_F = 0.38 \times V_{CC}$ , Positive $I_P$ , $T_A = 25^{\circ}\text{C}$ to $125^{\circ}\text{C}$	-20	$\pm 15$	20	%
		$VOC\_F = 0.38 \times V_{CC}$ , Positive $I_P$ , $T_A = -40^{\circ}\text{C}$ to $25^{\circ}\text{C}$	-	$\pm 25$	-	%
	$E_{FF(LOW)-}$	$VOC\_F = 0.38 \times V_{CC}$ , Negative $I_P$ , $T_A = 25^{\circ}\text{C}$	-20	$\pm 15$	20	%
		$VOC\_F = 0.38 \times V_{CC}$ , Negative $I_P$ , $T_A = 25^{\circ}\text{C}$ to $125^{\circ}\text{C}$	-20	$\pm 15$	20	%
		$VOC\_F = 0.38 \times V_{CC}$ , Negative $I_P$ , $T_A = -40^{\circ}\text{C}$ to $25^{\circ}\text{C}$	-	$\pm 30$	-	%
Slow Fault Error	$E_{SF(HIGH)}$	$VOC\_S = 0.7 \times V_{CC}$ , $I_P$ rising	-8	$\pm 4$	8	%
	$E_{SF(LOW)}$	$VOC\_S = 0.3 \times V_{CC}$ , $I_P$ rising	-10	$\pm 5$	10	%
Fast Fault Delay Code	-		0		-	
Slow Fault Delay Code	-		4		-	
<b>FAULT CHARACTERISTICS</b>						
Fast Fault Response Time	$t_{R(FF)}$	Time from $I_P$ rising above $I_{FF}$ until $V_{FAULT\_F} < V_{FAULTL}$ for a current step from 0 to $1.2 \times I_{FAULT(FAST)}$ ; $R_{PU} = 10\text{ k}\Omega$ , $100\text{ pF}$ from $FAULT\_F$ to ground	-	1.5	2	$\mu\text{s}$
Slow Fault Response Time	$t_{R(SF)}$	Time from $I_P$ rising above $I_{SF}$ until $V_{FAULT\_S} < V_{FAULTL}$ for a current step from 0 to $1.2 \times I_{FAULT(SLOW)}$ ; $R_{PU} = 10\text{ k}\Omega$ , $100\text{ pF}$ from $FAULT\_S$ to ground	-	13	-	$\mu\text{s}$

[1] Typical values with +/- are 3 sigma values.

[2] A single part will not have both the maximum/minimum sensitivity error and maximum/minimum offset voltage, as that would violate the maximum/minimum total output error specification. Also, 3 sigma distribution values are combined by taking the square root of the sum of the squares.

[3] Percentage of  $I_P$ , with  $I_P = I_{PR(max)}$ .

## APPLICATION INFORMATION: FAULT

### Fault Overview

The ACS720 has two customer-settable overcurrent fault comparators which trip when the absolute value of the input current,  $I_P$ , goes above the set threshold. The fast fault and slow fault are both active low outputs.

The Fast Fault, FAULT\_F, operates early in the signal path, allowing for ultrafast response times with reduced accuracy. The Slow Fault, FAULT\_S, operates later in the conditioned section of the signal path, resulting in higher accuracy. The Fast Fault feature is well suited for detecting gross short-circuit events, while the slow fault may be used to detect overload conditions, such as those found in motor applications.

The accuracy and response times for FAULT\_F and FAULT\_S may be found in the device performance tables of this datasheet.

### Setting Fast and Slow Fault Thresholds

The fault thresholds are user-settable, using the VOC\_F and VOC\_S pins for the fast and slow fault trip points, respectively. The fault thresholds may be set using a resistor divider on the VOC\_F and VOC\_S pins. The VOC\_F and VOC\_S pins are ratiometric to  $V_{CC}$  and have an acceptable input range of  $0.3 \times V_{CC}$  to  $0.7 \times V_{CC}$ . Figure 3 illustrates the linear relationship between  $I_{FAULT}$  and the  $V_{OC}$  voltages. Refer to the performance characteristics tables for factory-tested fault trip points.

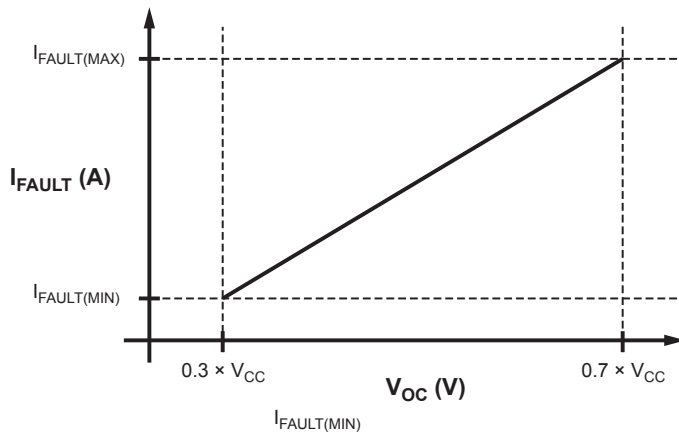

**Figure 3:  $I_{FAULT}$  versus  $V_{OC}$**

The resulting equation for the slow fault threshold is:

$$I_{FAULT(S)} = \frac{V_{OC(S)} - 0.3 \times V_{CC}}{0.4 \times V_{CC}} \times (0.75 \times I_{PR}) + 0.5 \times I_{PR} \quad (1)$$

This may be inverted to solve for the VOC\_S voltage relating to the desired fault threshold:

$$V_{OC(S)} = \frac{(I_{FAULT(S)} - 0.5 \times I_{PR}) \times 0.4 \times V_{CC}}{0.75 \times I_{PR}} + (0.3 \times V_{CC}) \quad (2)$$

The resulting equation for the fast fault threshold is:

$$I_{FAULT(F)} = \frac{V_{OC(F)} - 0.3 \times V_{CC}}{0.4 \times V_{CC}} \times (1.25 \times I_{PR}) + 1.0 \times I_{PR} \quad (3)$$

This may be inverted to solve for the VOC\_F voltage relating to the desired fault threshold:

$$V_{OC(F)} = \frac{(I_{FAULT(F)} - 1.0 \times I_{PR}) \times 0.4 \times V_{CC}}{1.25 \times I_{PR}} + (0.3 \times V_{CC}) \quad (4)$$

The  $V_{CC}$  voltage serves as a reference to VOC pins making the adjustable fault threshold immune to changes in  $V_{CC}$ . The VOC pins are sampled at 62.5 kHz; therefore, it is best practice to filter the input to VOC pins below 31 kHz to avoid aliasing. The application schematic for the VOC pins and anti-aliasing capacitor is shown in Figure 4.

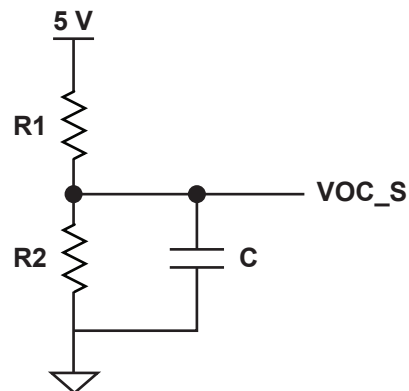

**Figure 4: Resistor Divider**

The capacitor, C, may be sized using the following equation:

$$f = \frac{1}{2\pi \times (R1 \parallel R2) \times C} = \frac{1}{2\pi \times \left(\frac{R1 \times R2}{R1 + R2}\right) \times C} \quad (5)$$

(1) The VOC update rate is 7.8 kHz, allowing for eight samples to be averaged each update.

### Fault Response Time and Hysteresis

The Fault Response Time,  $t_{R(F)}$ , is defined from  $I_P$  rising above the fault threshold,  $I_{FAULT}$ , until the fault pin voltage falls below  $V_{FAULTL}$ , and is based on an input current step from 0 A to  $1.2 \times I_{FAULT}$ . This definition is applicable to both fast and slow fault circuits. When the current through  $I_P$  crosses the  $I_{FAULT}$  threshold, the fault comparator will trip, and after  $t_{R(F)}$ , the fault pin will assert. When the input current level drops below  $I_{FAULT} - I_{HYS}$ , the fault comparator will clear, and after  $t_{C(F)}$ , the fault pin will clear, as indicated in Figure 5.

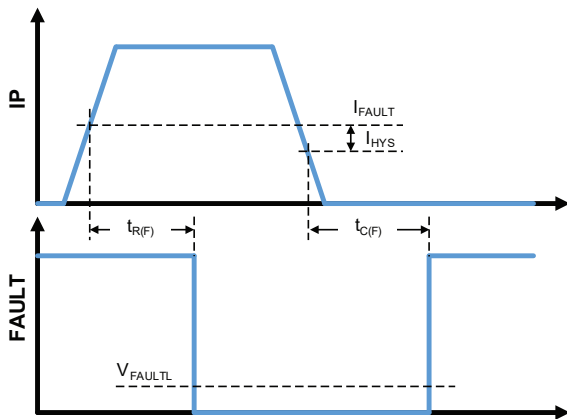

Figure 5: Fault Response Timing Diagram

### Fault Masking and Nuisance Pulses

Certain ACS720 part numbers are programmed to report over-current events immediately and are factory-programmed with an ultrafast response time. This behavior is illustrated in the timing diagram in Figure 6. Note that fault response and fault clear times,  $t_{R(F)}$  and  $t_{C(F)}$ , still apply.

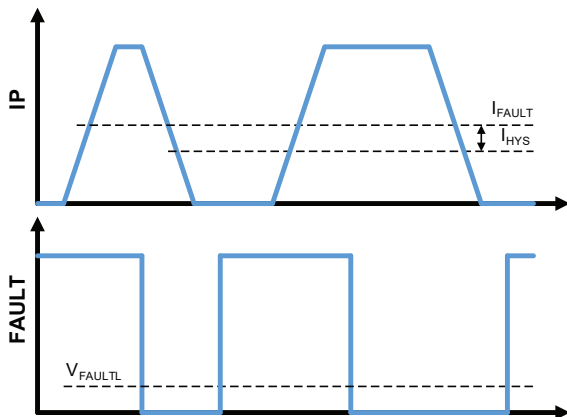

Figure 6: Non-Masked Nuisance Timing Diagram

Conversely, other ACS720 part numbers are factory-programmed with a mask time,  $t_{MASK}$ , which enables the device to ignore nuisance current pulses in application. This behavior is illustrated in Figure 7, where the width of the first pulse is less than  $t_{MASK}$  and the fault is not reported. Note that response and clear times,  $t_{R(F)}$  and  $t_{C(F)}$ , still apply.

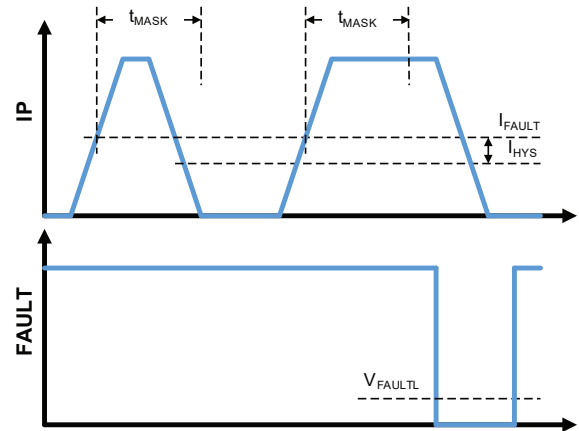

Figure 7: Masked Nuisance Timing Diagram

Due to the chopped and sampled nature of the ACS720 system, it is possible for repetitive high-frequency nuisance pulses to be interpreted as a single continuous overcurrent event. If the blank time,  $t_B$ , between pulses is  $< 4 \mu s$ , this may occur.

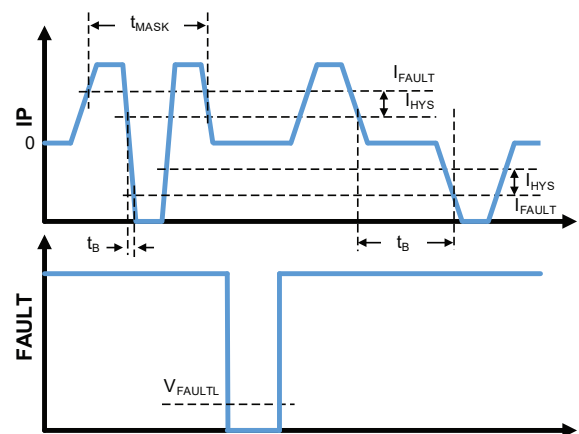

Figure 8: Nuisance Pulse Train Resulting in Fault Assertion

## DEFINITIONS OF ACCURACY CHARACTERISTICS

**Sensitivity (Sens).** The change in sensor IC output in response to a 1 A change through the primary conductor. The sensitivity is the product of the magnetic circuit sensitivity (G/A) (1 G = 0.1 mT) and the linear IC amplifier gain (mV/G). The linear IC amplifier gain is programmed at the factory to optimize the sensitivity (mV/A) for the full-scale current of the device.

**Nonlinearity ( $E_{LIN}$ ).** The nonlinearity is a measure of how linear the output of the sensor IC is over the full current measurement range. The nonlinearity is calculated as:

$$E_{LIN} = \left\{ 1 - \left[ \frac{V_{IOUT}(I_{PR(max)}) - V_{IOUT(Q)}}{2 \times V_{IOUT}(I_{PR(max)/2}) - V_{IOUT(Q)}} \right] \right\} \times 100(\%) \quad (6)$$

where  $V_{IOUT}(I_{PR(max)})$  is the output of the sensor IC with the maximum measurement current flowing through it and  $V_{IOUT}(I_{PR(max)/2})$  is the output of the sensor IC with half of the maximum measurement current flowing through it.

**Zero-Current Output Voltage ( $V_{IOUT(Q)}$ ).** The output of the sensor when the primary current is zero.  $V_{IOUT(Q)}$  is nominally 1.5 V. Variation in  $V_{IOUT(Q)}$  can be attributed to the resolution of the Allegro linear IC quiescent voltage trim and thermal drift.

**Offset Voltage ( $V_{OE}$ ).** The deviation of the device output from its ideal quiescent value of 1.5 V due to nonmagnetic causes. To convert this voltage to amperes, divide by the device sensitivity, Sens.

**Total Output Error ( $E_{TOT}$ ).** The difference between the current measurement from the sensor IC and the actual current ( $I_P$ ), relative to the actual current. This is equivalent to the difference between the ideal output voltage and the actual output voltage, divided by the ideal sensitivity, relative to the current flowing through the primary conduction path:

$$E_{TOT}(I_P) = \frac{V_{IOUT,ideal}(I_P) - V_{IOUT}(I_P)}{Sens_{ideal}(I_P) \times I_P} \times 100(\%) \quad (7)$$

The Total Output Error incorporates all sources of error and is a function of  $I_P$ . At relatively high currents,  $E_{TOT}$  will be mostly due to sensitivity error, and at relatively low currents,  $E_{TOT}$  will be mostly due to Offset Voltage ( $V_{OE}$ ). In fact, at  $I_P = 0$ ,  $E_{TOT}$  approaches infinity due to the offset. This is illustrated in Figure 9 and Figure 10. Figure 9 shows a distribution of output voltages versus  $I_P$  at 25°C and across temperature. Figure 10 shows the corresponding  $E_{TOT}$  versus  $I_P$ .

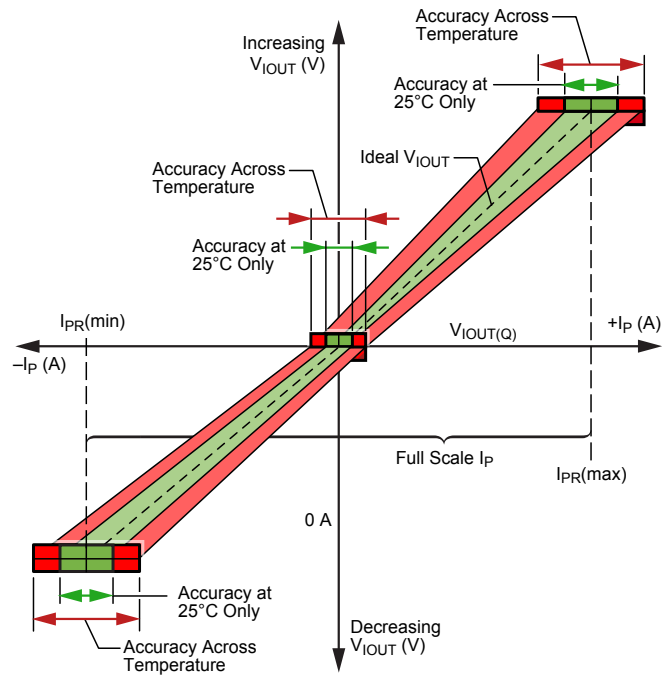

Figure 9: Output Voltage versus Sensed Current

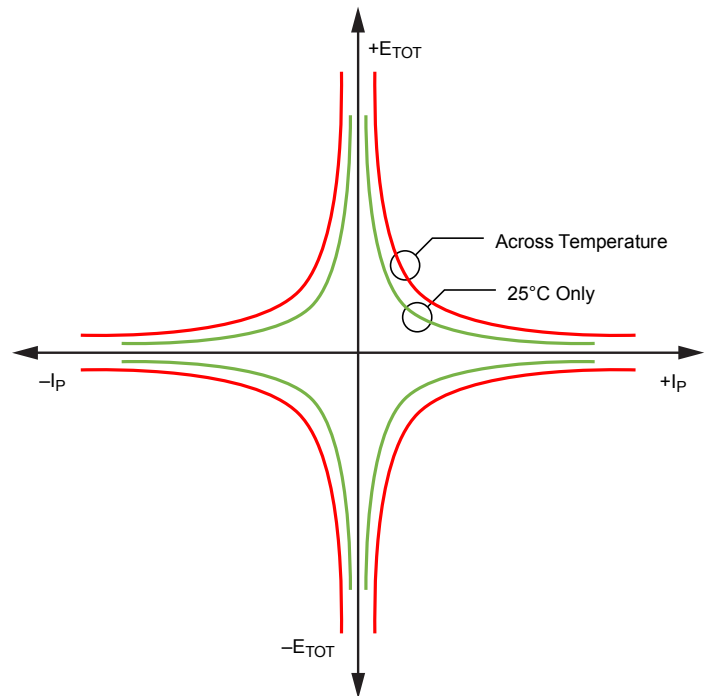

Figure 10: Total Output Error versus Sensed Current

### Common Mode Field Rejection

Common Mode Field Rejection (CMFR) measures the ability of the device to reject common-mode magnetic signals. It is defined as the ratio between the voltage swing due to a magnetic field divided by the magnetic field and the gain of the sensor in dB.

$$CMFR = 20 \log_{10} \left| \frac{A_{CM}}{Sens/CF} \right|$$

where  $A_{CM}$  is the gain measured due to an external field in mV/G and CF is the coupling factor of the integrated current loop.

For a sensitivity (Sens) of 50 mV/A, a coupling factor of 12 G/A, a CMFR of -40 dB and a 1 G external field, the output will swing 6 mV.

### Power Supply Rejection Ratio

#### Sensitivity Power Supply Rejection Ratio (PSRRS).

The ratio of the percent change in sensitivity from the sensitivity at nominal supply voltage ( $V_{CCN}$ ) to the percent change in  $V_{CC}$  in dB.

$$PSRR_S = 20 \log_{10} \left| \frac{[Sens_{V_{CCN}} \times (V_{CC} - V_{CCN})]}{[(Sens_{V_{CC}} - Sens_{V_{CCN}}) \times V_{CCN}]} \right|$$

A  $PSRR_S$  value of 40 dB means that a 5% change in  $V_{CC}$  (going from 5 to 5.25 V, for example) results in around a 0.05% change in sensitivity.

#### Quiescent Voltage Power Supply Rejection Ratio (PSRRQ).

The ratio of the change in quiescent voltage to the change in  $V_{CC}$  in dB.

$$PSRR_Q = 20 \log_{10} \left| \frac{(\Delta V_{CC})}{(\Delta V_{IOUT(Q)})} \right|$$

A  $PSRR_Q$  value of 40 dB means a 250 mV change in  $V_{CC}$  (going from 5 to 5.25 V, for example) results in a 2.5 mV change in quiescent voltage.

### DEFINITIONS OF DYNAMIC RESPONSE CHARACTERISTICS

**Power-On Time ( $t_{PO}$ ).** When the supply is ramped to its operating voltage, the device requires a finite time to power its internal components before responding to an input magnetic field. Power-On Time,  $t_{PO}$ , is defined as the time it takes for the output voltage to settle within  $\pm 10\%$  of its steady-state value under an applied magnetic field, after the power supply has reached its minimum specified operating voltage,  $V_{CC(min)}$ , as shown in the chart at right.

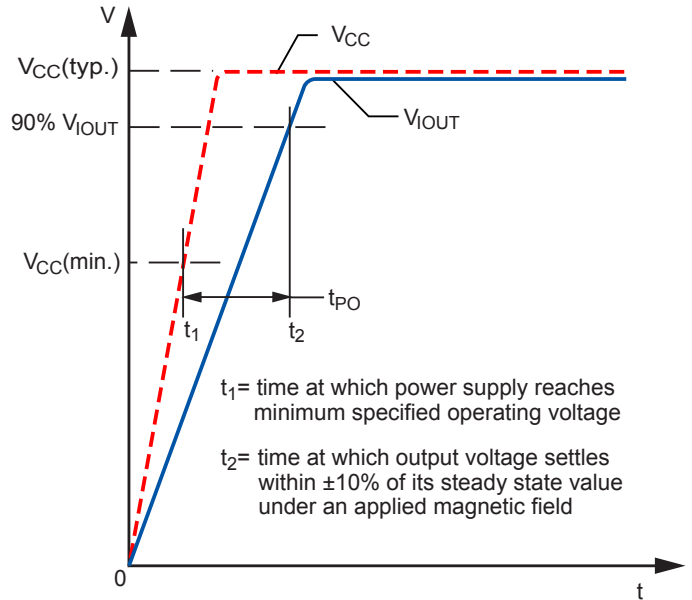

Figure 11: Power-On Time ( $t_{PO}$ )

**Rise Time ( $t_r$ ).** The time interval between a) when the sensor IC reaches 10% of its full-scale value, and b) when it reaches 90% of its full-scale value. The rise time to a step response is used to derive the bandwidth of the current sensor IC, in which  $f(-3 \text{ dB}) = 0.35/t_r$ . Both  $t_r$  and  $t_{RESPONSE}$  are detrimentally affected by eddy-current losses observed in the conductive IC ground plane.

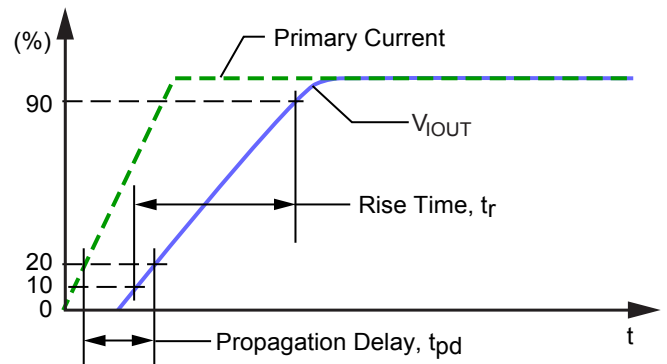

Figure 12: Rise Time ( $t_r$ ) and Propagation Delay ( $t_{pd}$ )

**Propagation Delay ( $t_{pd}$ ).** The propagation delay is measured as the time interval a) when the primary current signal reaches 20% of its final value, and b) when the device reaches 20% of its output corresponding to the applied current.

**Response Time ( $t_{RESPONSE}$ ).** The time interval between a) when the primary current signal reaches 90% of its final value, and b) when the device reaches 90% of its output corresponding to the applied current.

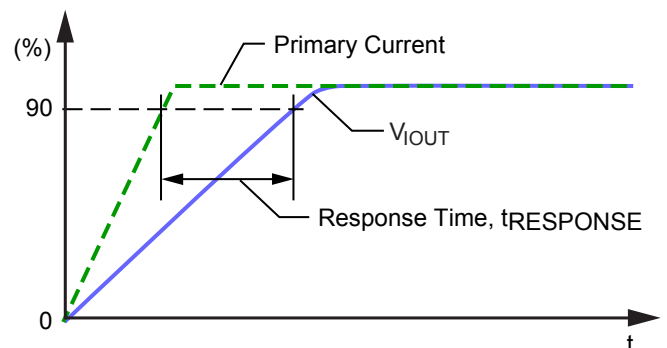
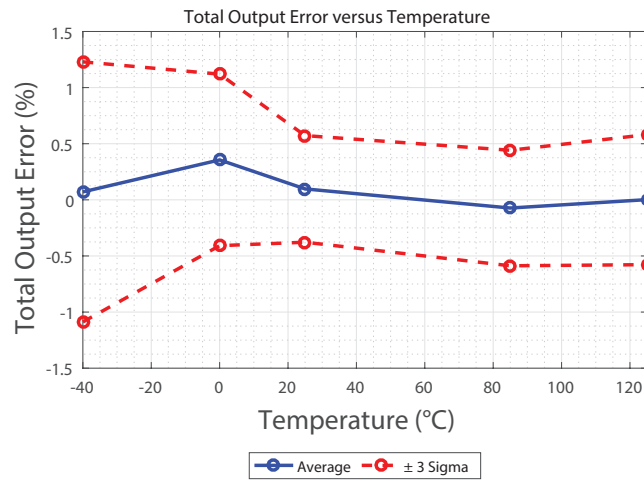
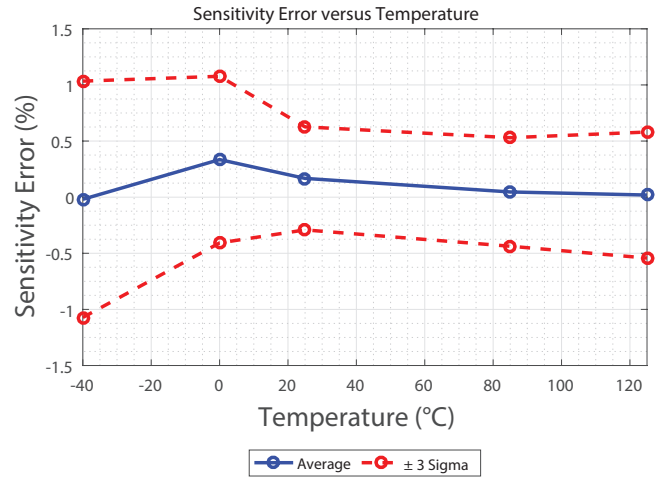
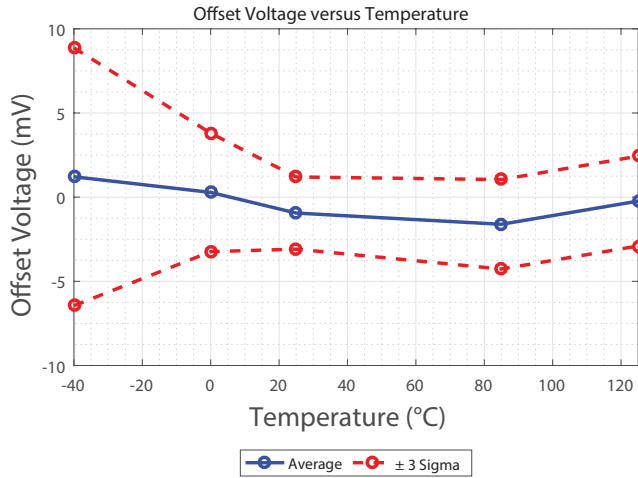

Figure 13: Response Time ( $t_{RESPONSE}$ )

**Fault Response Time ( $t_{RFF}$ ,  $t_{RSF}$ ).** The time interval between a) when the primary current signal reaches the fault threshold, and b) when the device fault pin reacts to the current event. A current of 20% above the fault trip level should be used to guarantee fault timing.

### CHARACTERIZATION DATA ACS720KLATR-15AB-T



### CHARACTERIZATION DATA ACS720KLATR-15AB-T

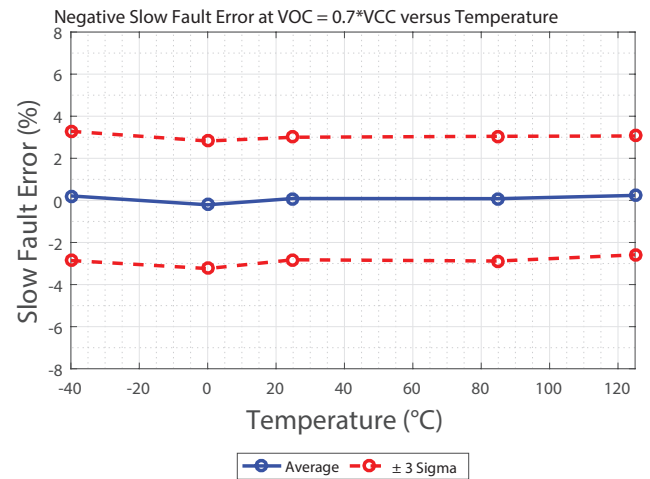
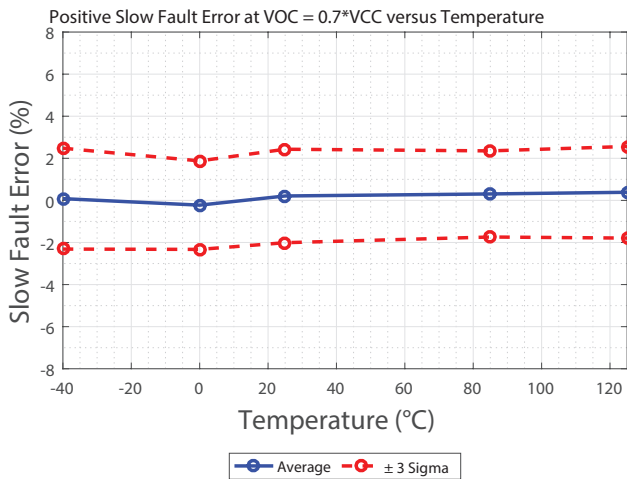
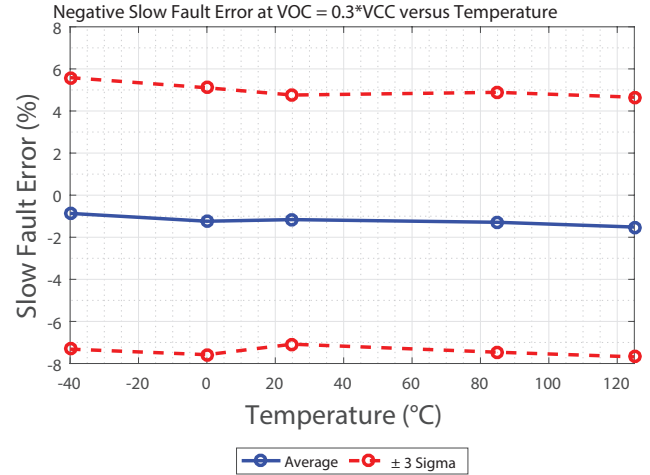
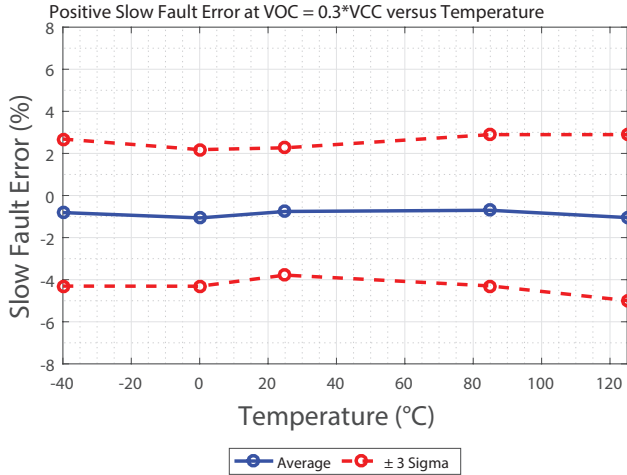



### CHARACTERIZATION DATA ACS720KLATR-15AB-T

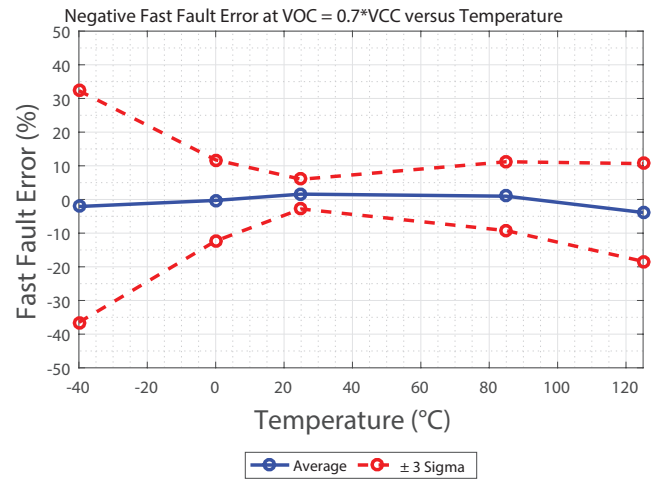
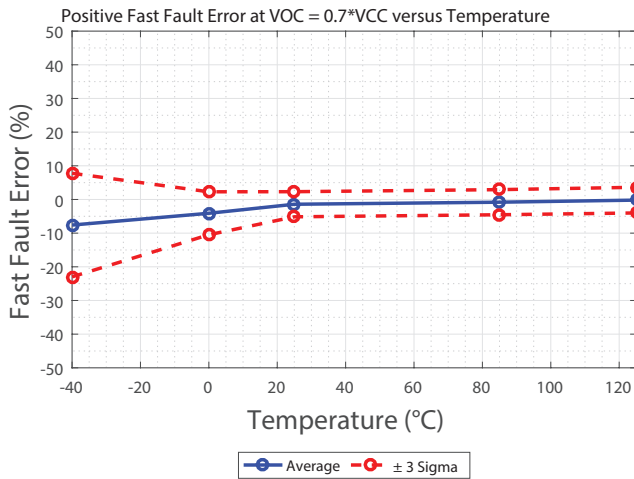
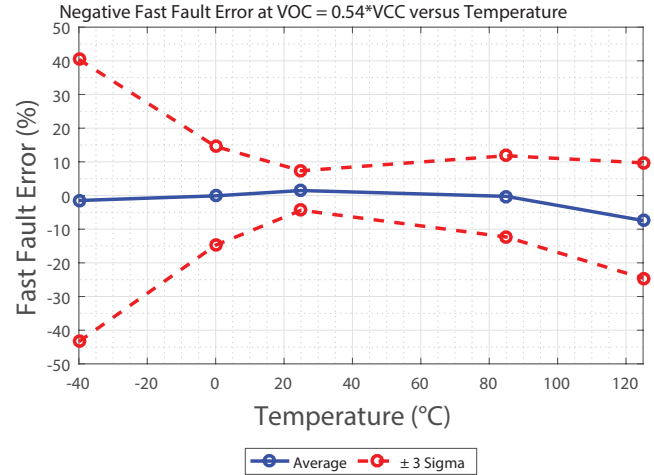
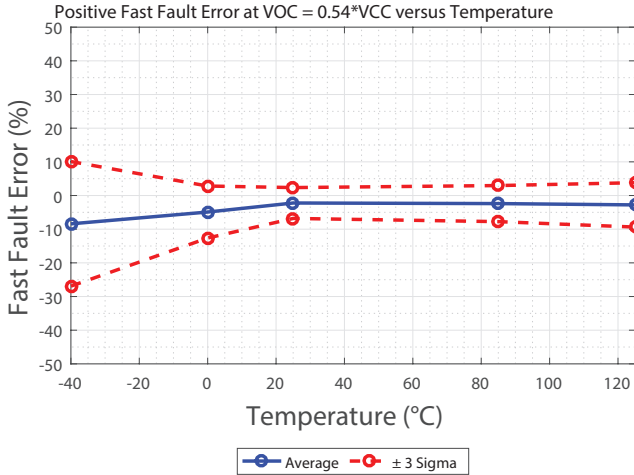

### CHARACTERIZATION DATA ACS720KLATR-35AB-T

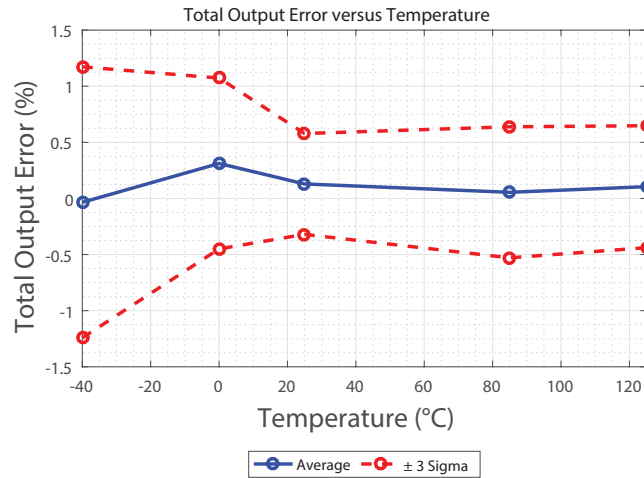
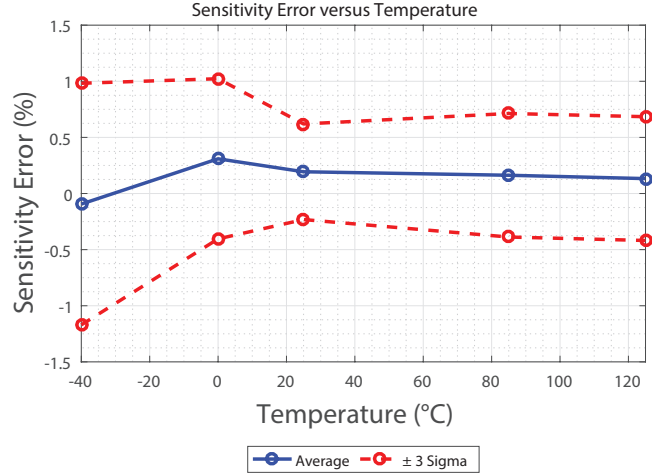
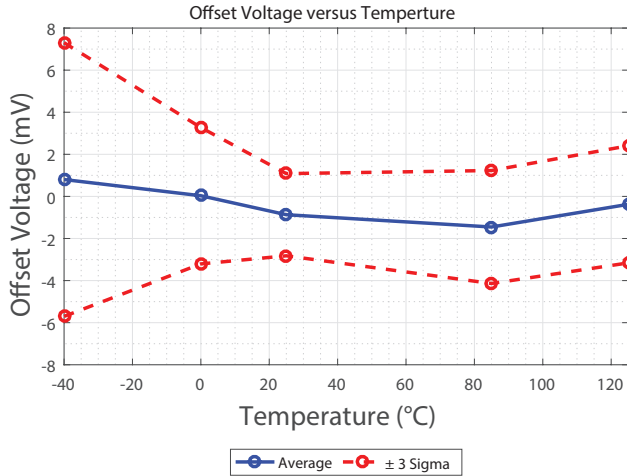

### CHARACTERIZATION DATA ACS720KLATR-35AB-T

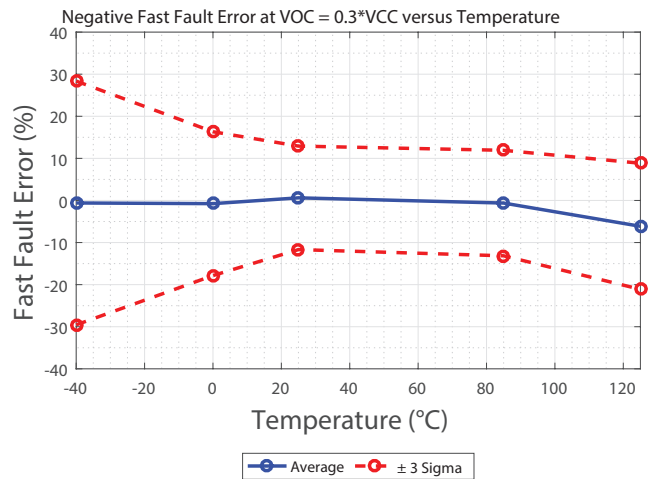
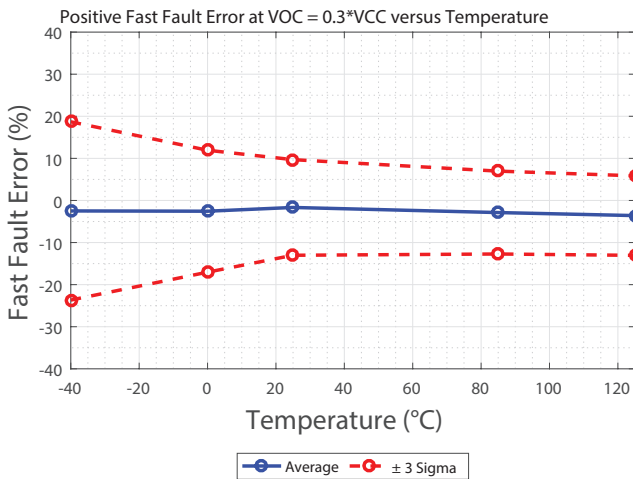
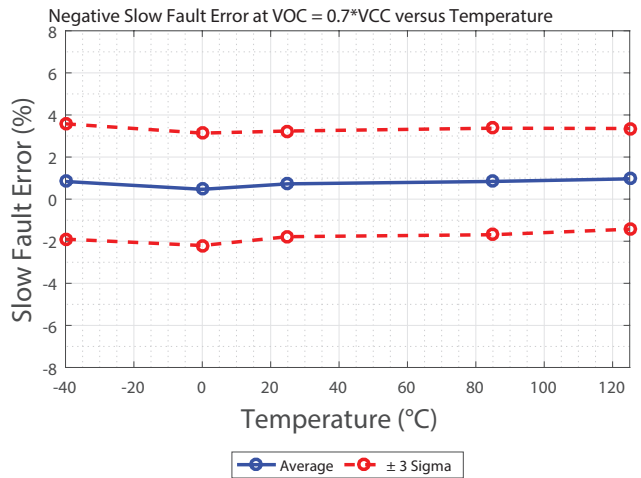
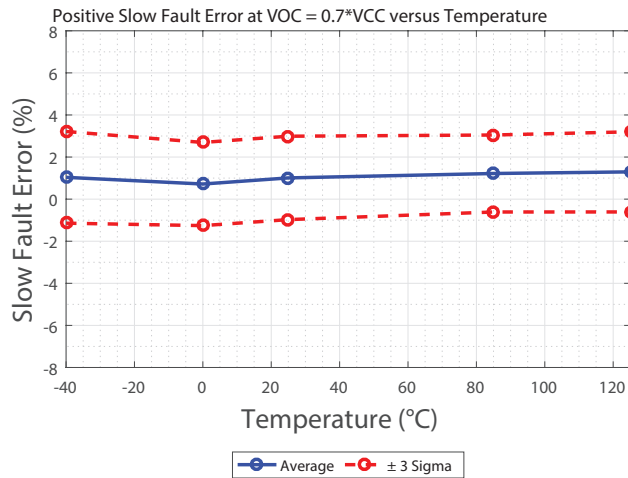
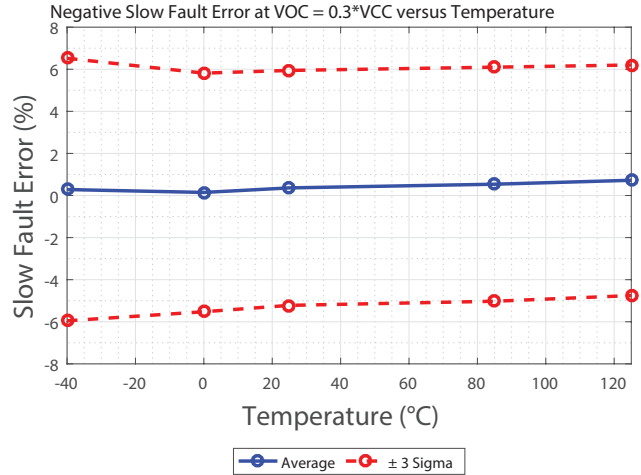
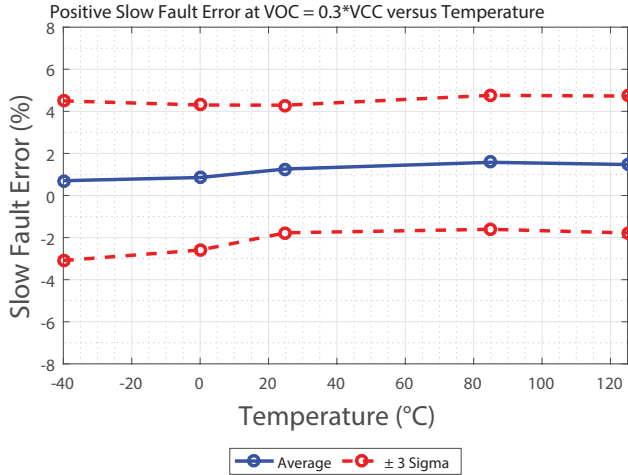

### CHARACTERIZATION DATA ACS720KLATR-35AB-T

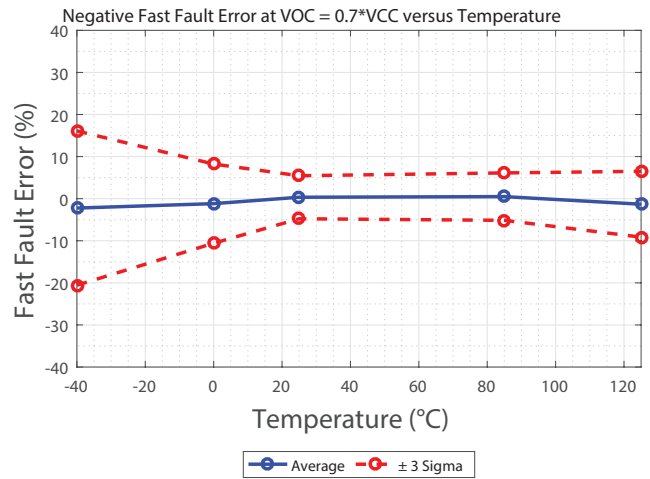
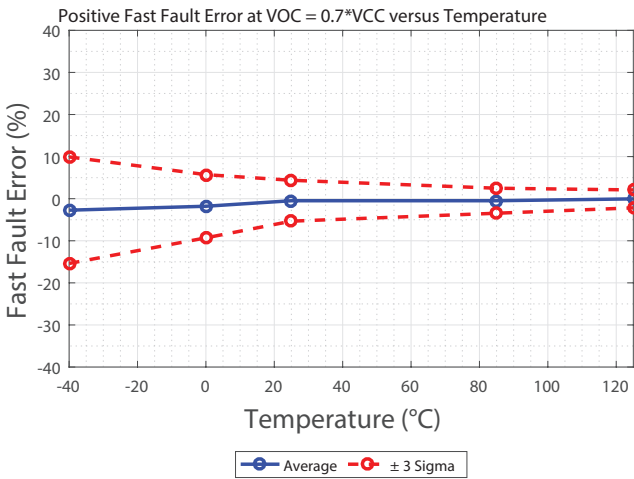
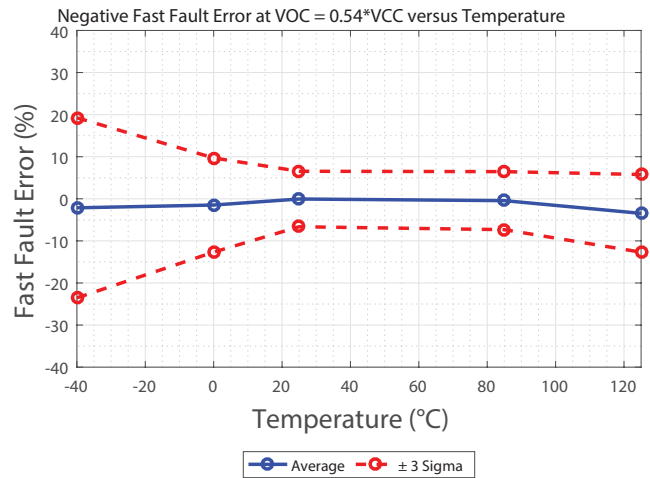
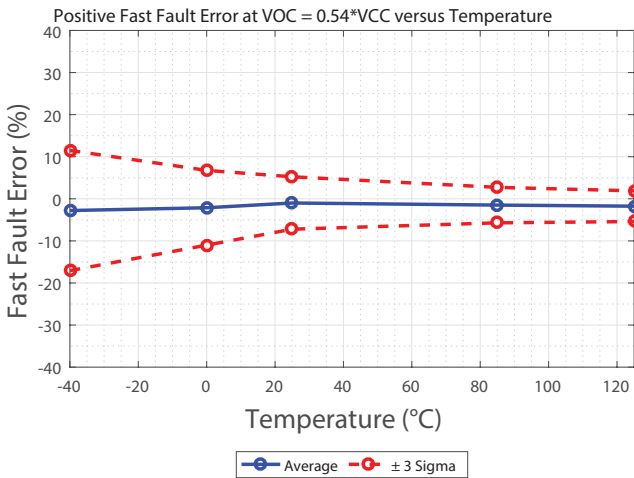
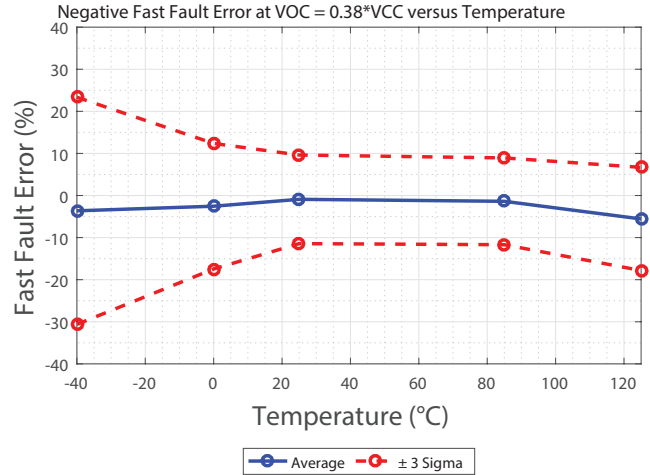
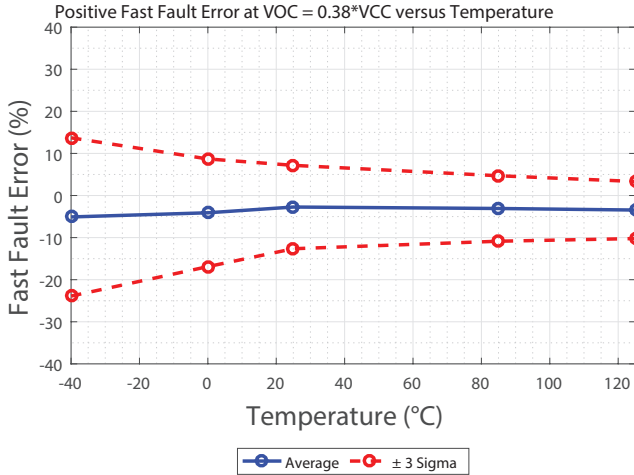

### CHARACTERIZATION DATA ACS720KLATR-65AB-T

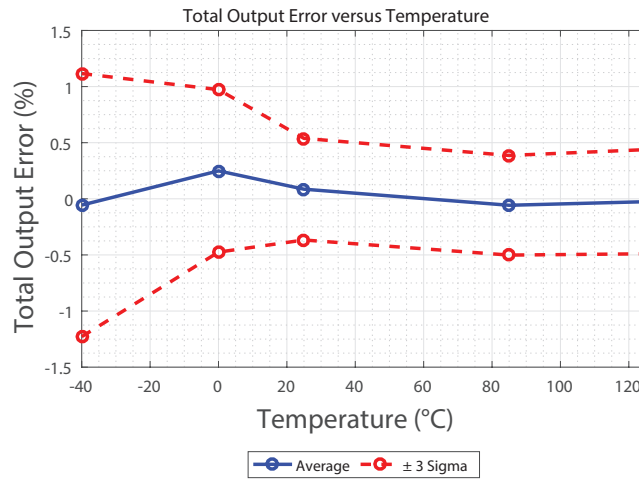
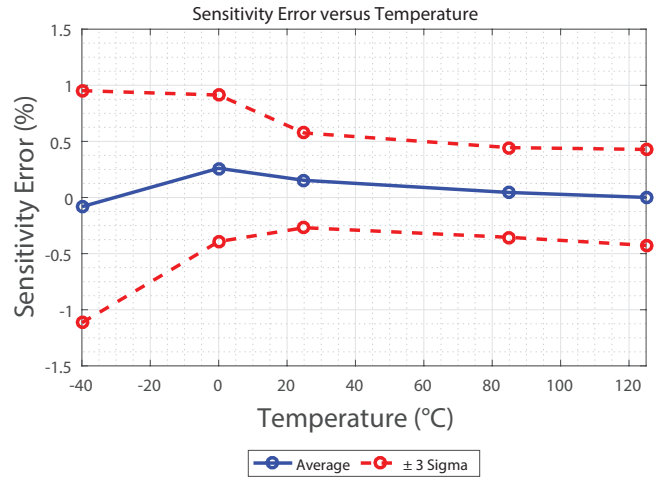
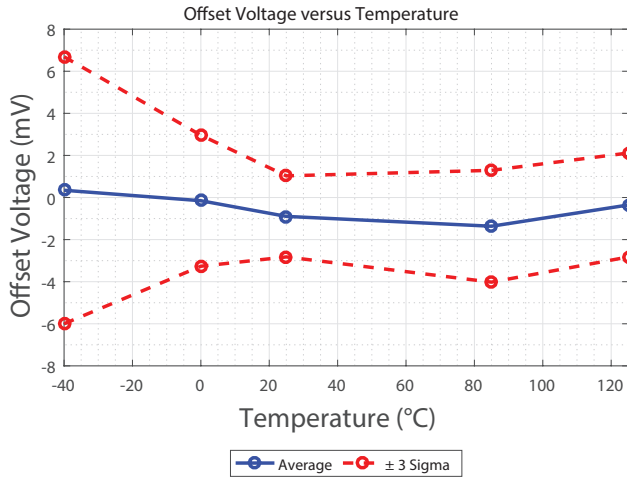

### CHARACTERIZATION DATA ACS720KLATR-65AB-T

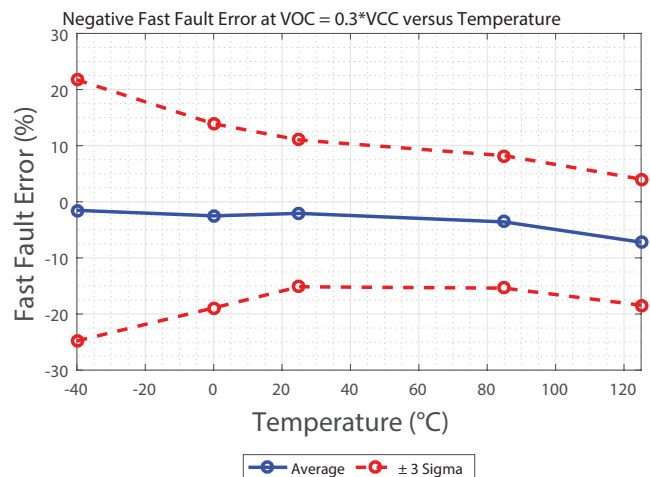
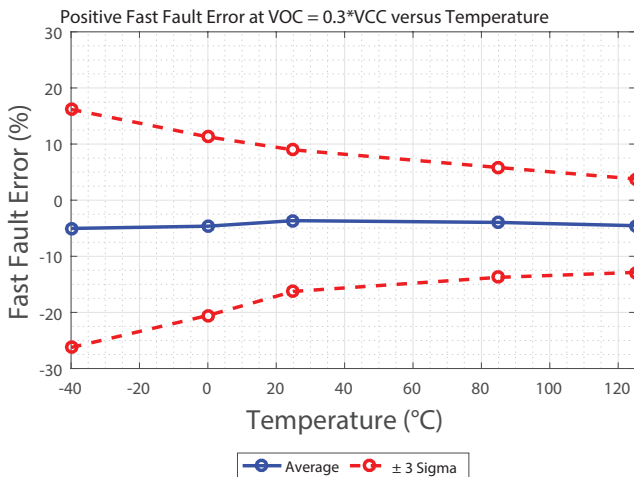
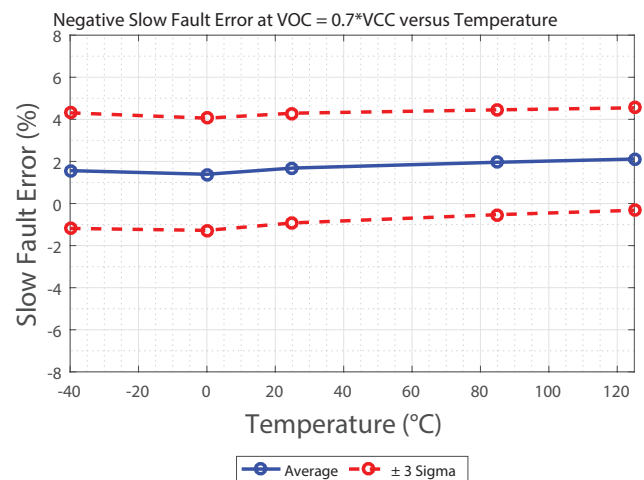
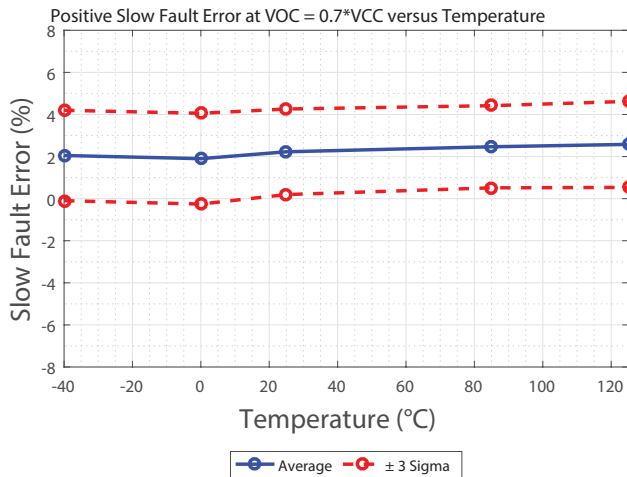
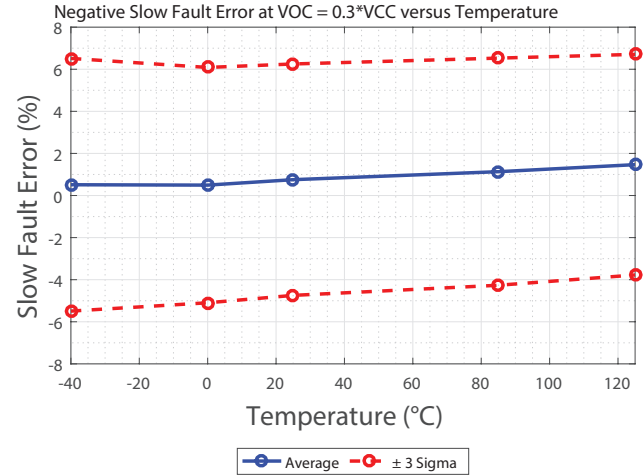
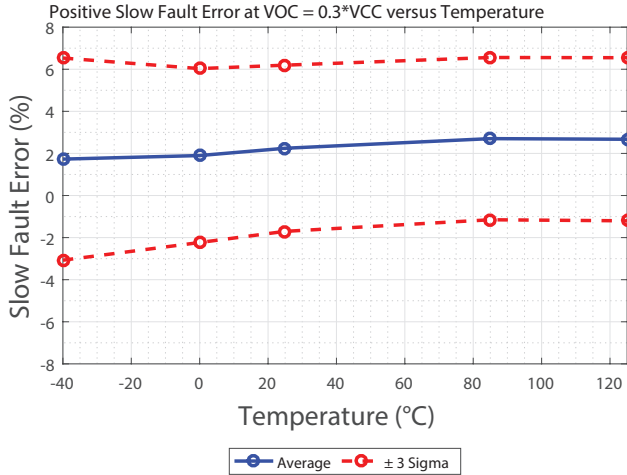

### CHARACTERIZATION DATA ACS720KLATR-65AB-T

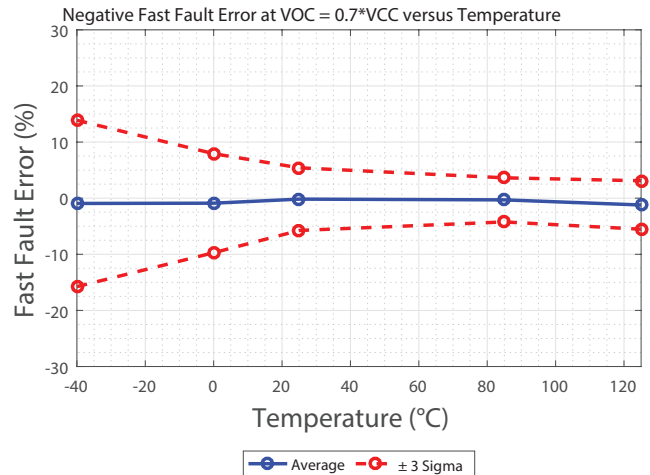
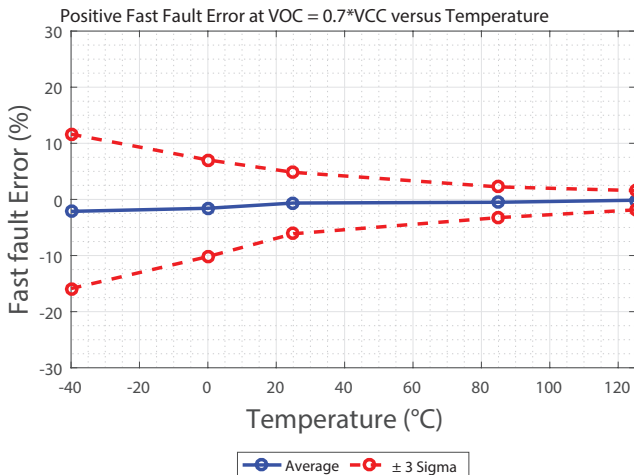
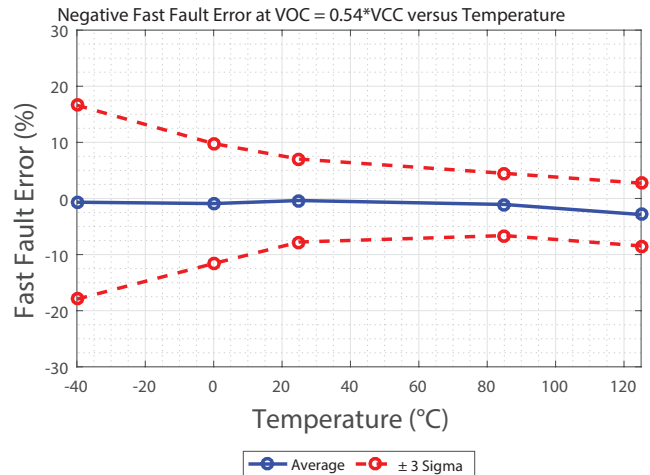
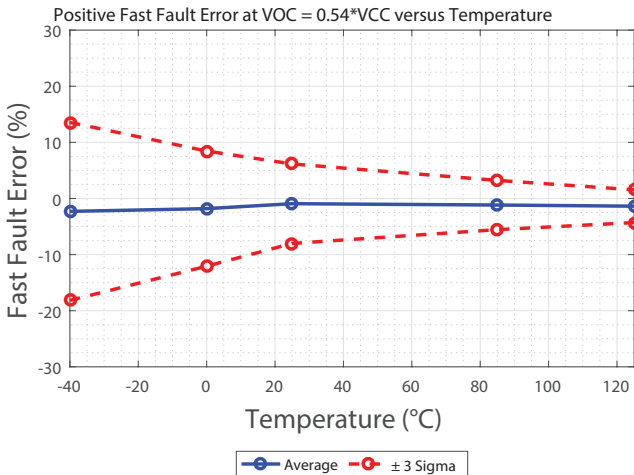
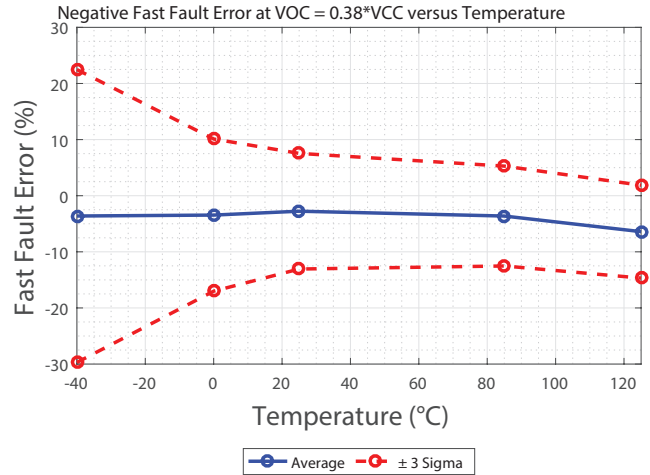
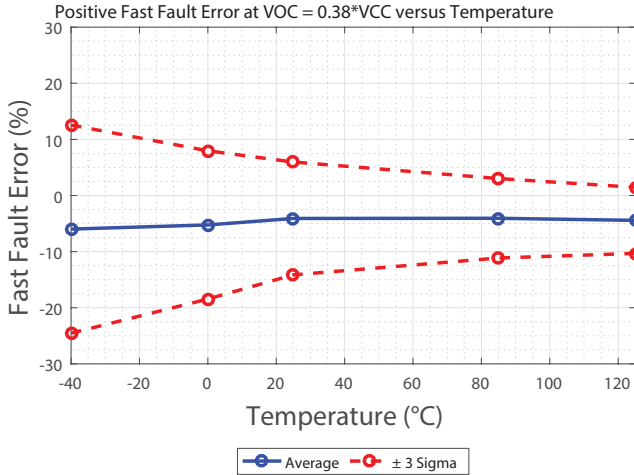

### CHARACTERIZATION DATA ACS720KLATR-80AB-T

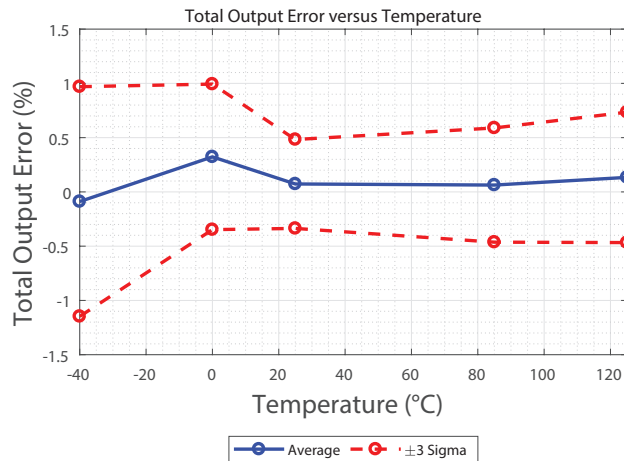
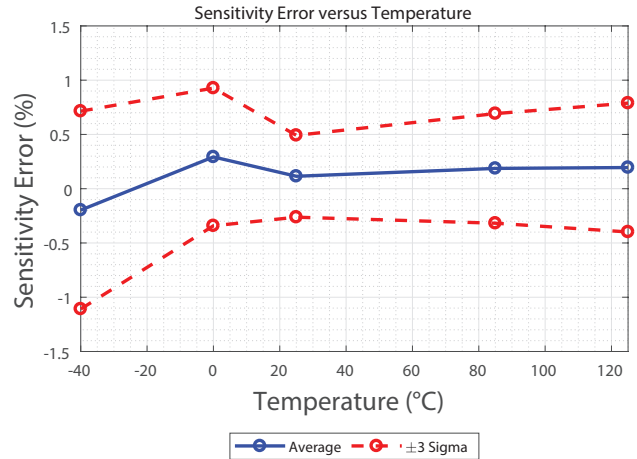
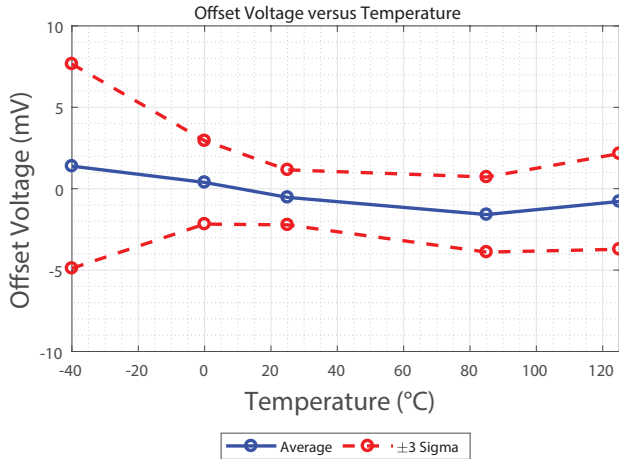



### CHARACTERIZATION DATA ACS720KLATR-80AB-T

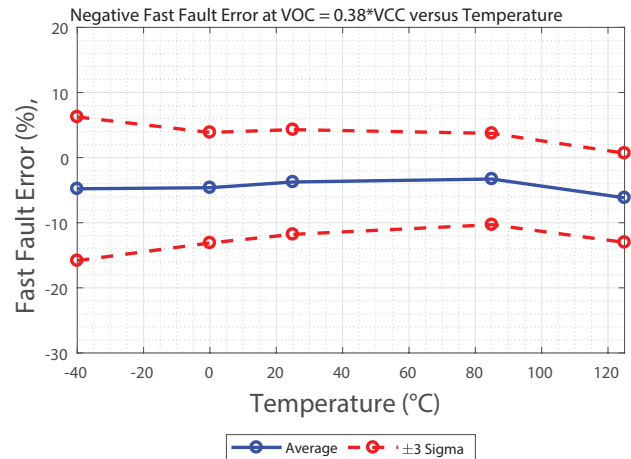
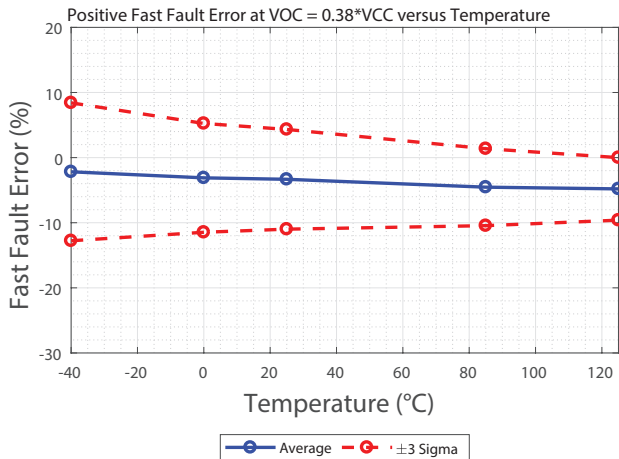
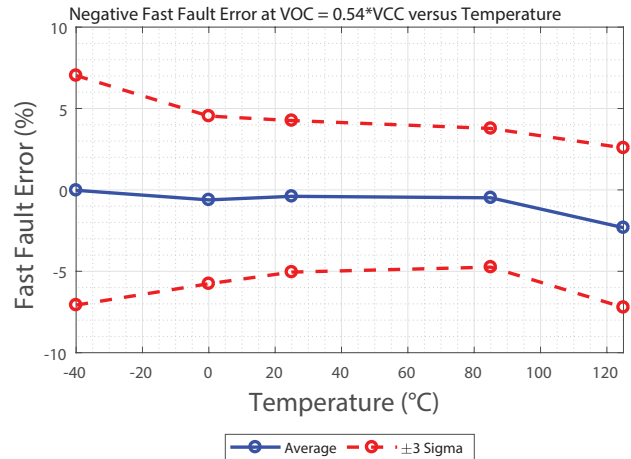
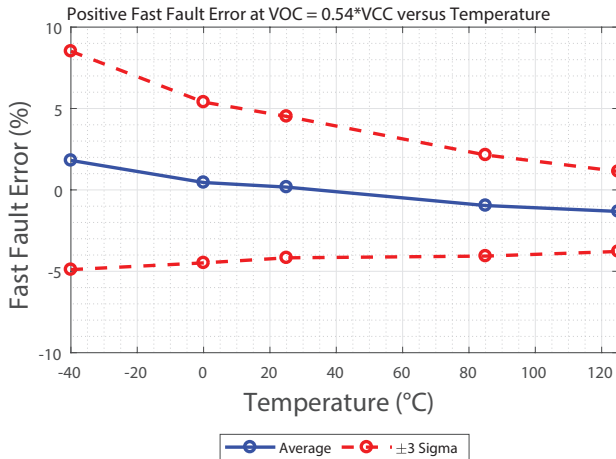
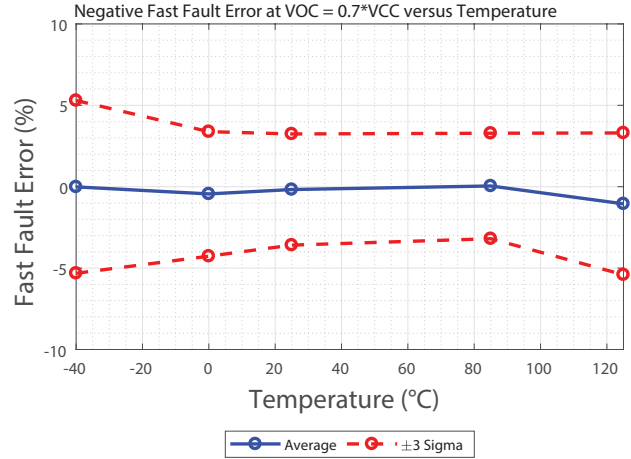
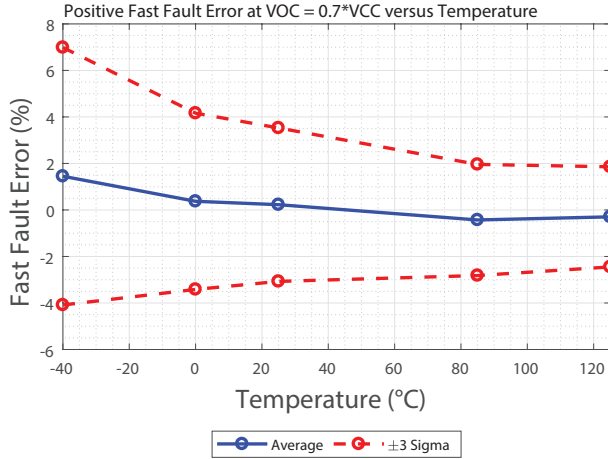

### CHARACTERIZATION DATA ACS720KLATR-80AB-T

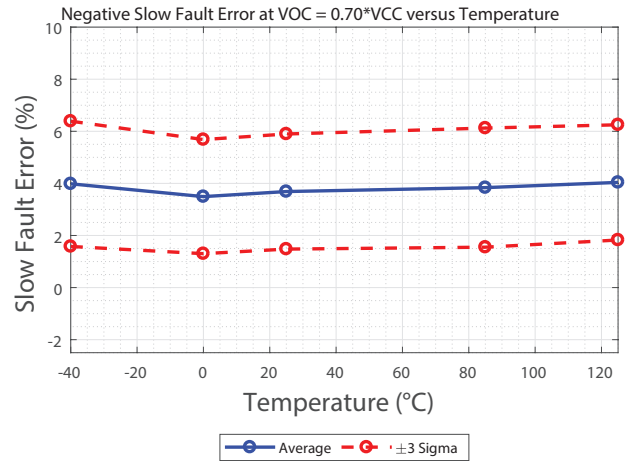
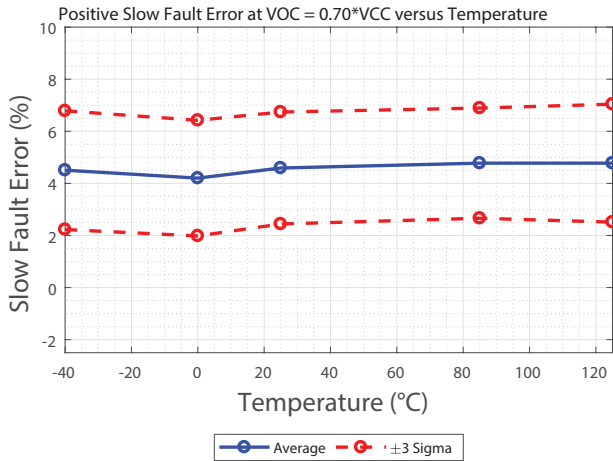
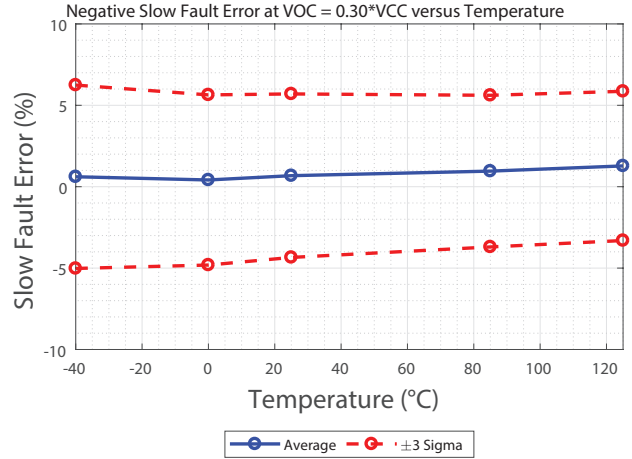
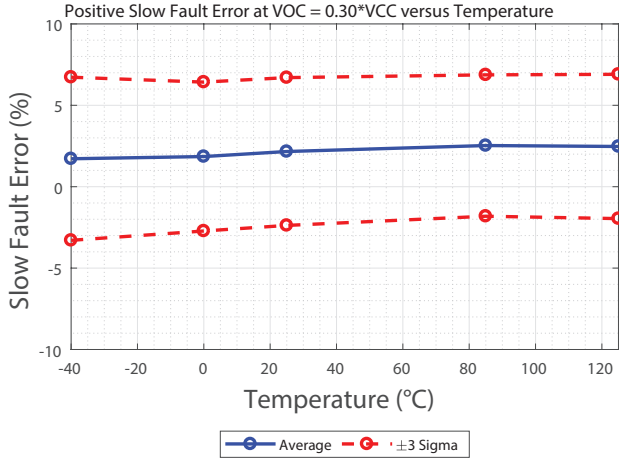

### CHARACTERIZATION DATA

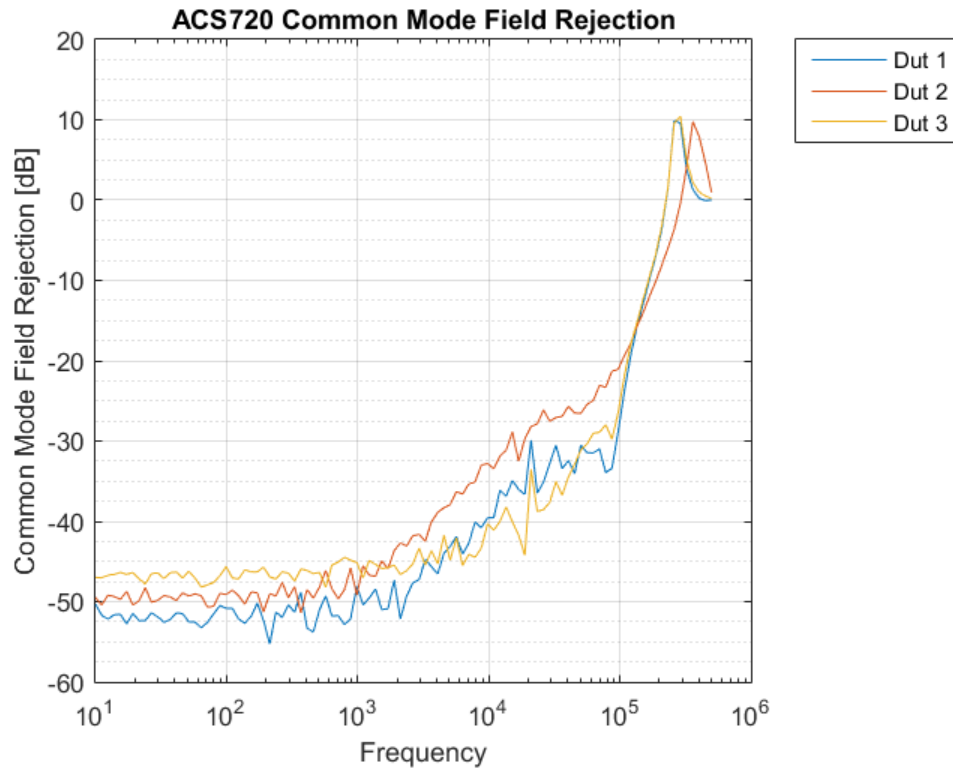

### Power Supply Rejection Ratio

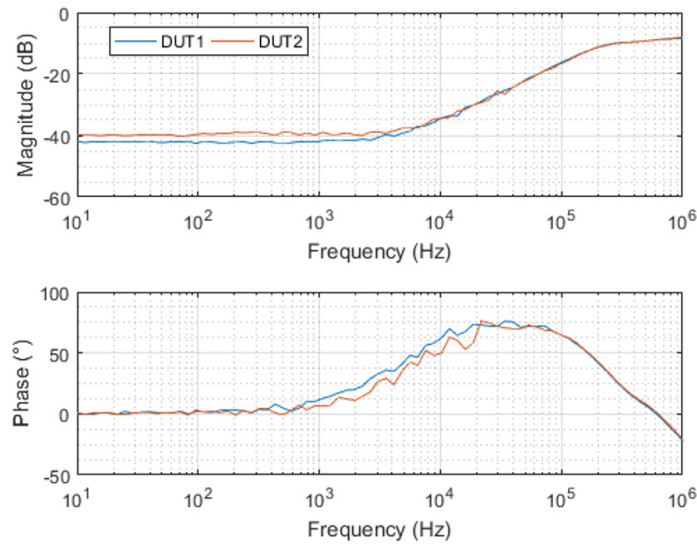

### RECOMMENDED PCB LAYOUT

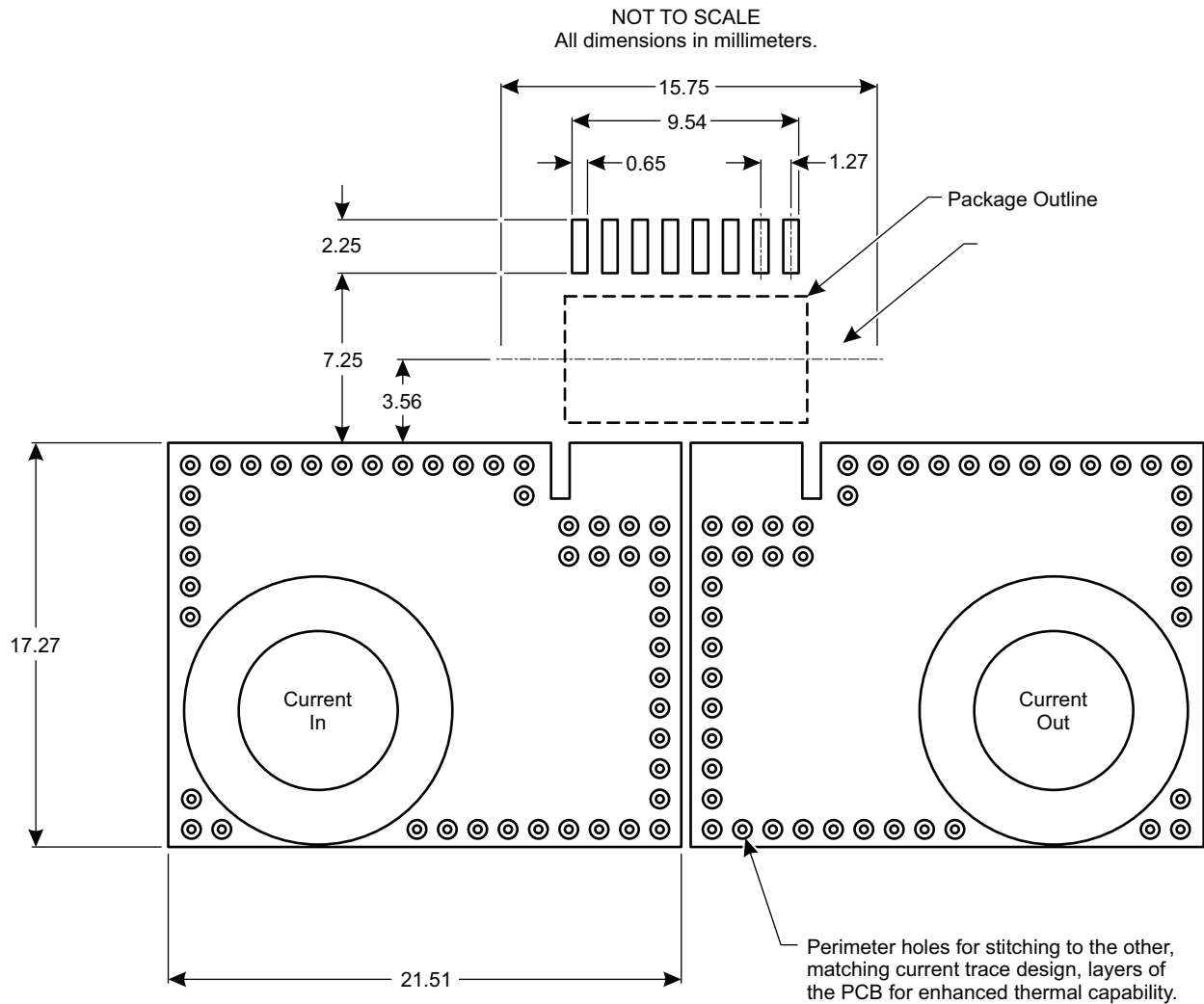

Figure 14: High Isolation PCB Layout

For additional information on layout, see:

<http://www.allegromicro.com/en/Design-Center/Technical-Documents/Hall-Effect-Sensor-IC-Publications/Techniques-Minimize-Common-Mode-Field-Interference.aspx>

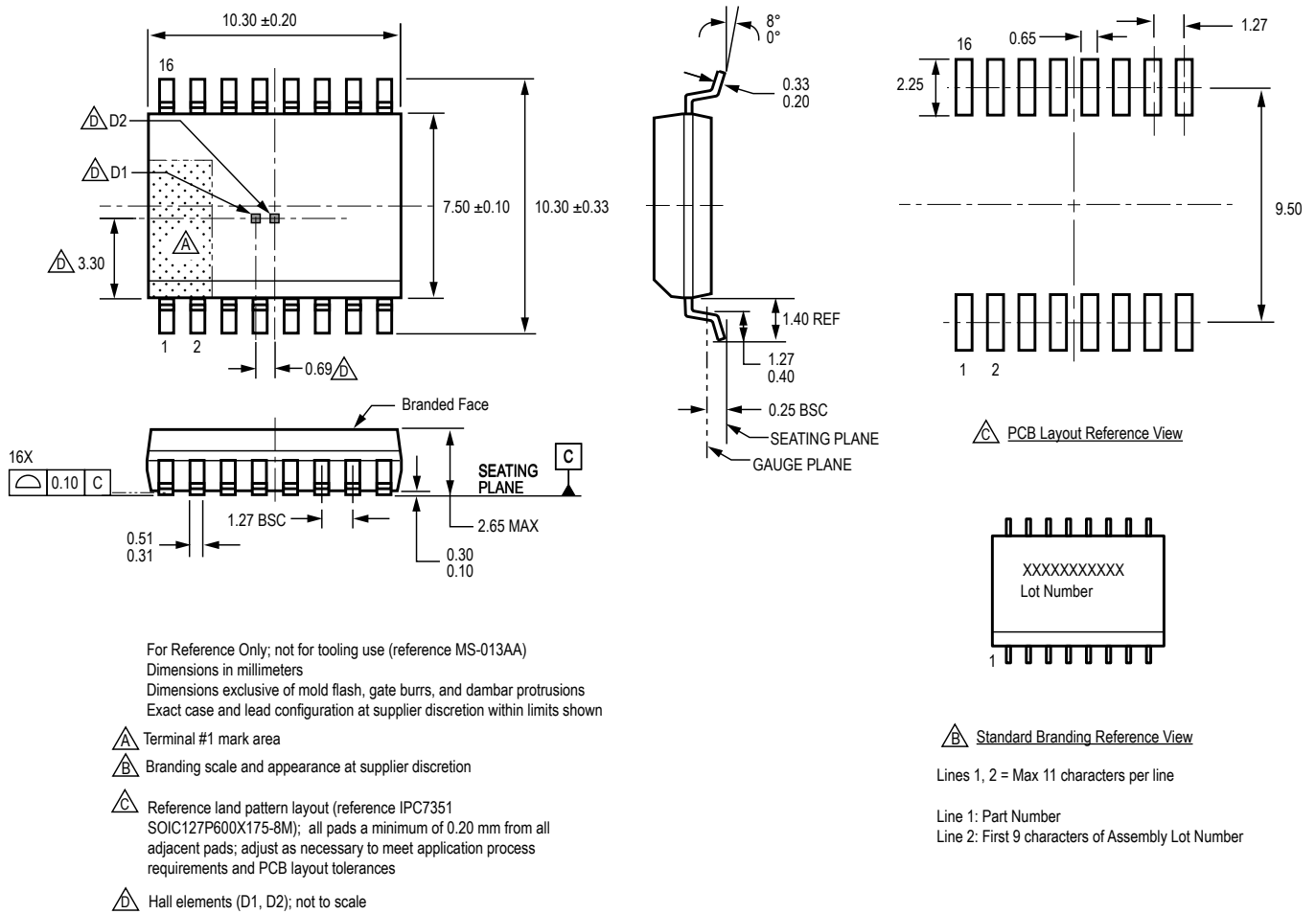

Figure 15: Package LA, 16-pin SOICW

**Revision History**

Number	Date	Description
–	August 30, 2017	Initial release
1	November 13, 2017	Corrected typo in Dielectric Surge Strength Test Voltage notes of Isolation Characteristics table (p. 3)
2	December 12, 2017	Corrected branding information (p. 25)
3	April 2, 2018	Added ACS720KLATR-80AB-T part variant.
4	May 3, 2018	Moved Fault Timing Characteristics from Common Operating Characteristics table to Performance Characteristics tables (page 5-9); Updated Fault Application Information (pages 10-11)
5	June 20, 2018	Added Common Mode Field Rejection Ratio characteristic to Common Operating Characteristics table (page 4)

Copyright ©2018, Allegro MicroSystems, LLC

Allegro MicroSystems, LLC reserves the right to make, from time to time, such departures from the detail specifications as may be required to permit improvements in the performance, reliability, or manufacturability of its products. Before placing an order, the user is cautioned to verify that the information being relied upon is current.

Allegro's products are not to be used in any devices or systems, including but not limited to life support devices or systems, in which a failure of Allegro's product can reasonably be expected to cause bodily harm.

The information included herein is believed to be accurate and reliable. However, Allegro MicroSystems, LLC assumes no responsibility for its use; nor for any infringement of patents or other rights of third parties which may result from its use.

Copies of this document are considered uncontrolled documents.

For the latest version of this document, visit our website:

[www.allegromicro.com](http://www.allegromicro.com)

