

Features

Regulated Converters

- Wide 2:1 Input Voltage Range
- 1.6kVDC Isolation
- UL Certified
- Efficiency up to 91%
- Six-Sided Continuous Shield
- No Minimum Load

RP20-A

20 Watt
1" x 1"
Single & Dual Output



Description

The RP20-A series are ultraminiature 2:1 input voltage range power DC/DC converters in a case half the size of industry standard 20W converters. Despite their small size, the RP20-A converters are fully specified devices with output currents up to 4.5 Amps, up to 91% efficiency, no minimum load, 1600VDC isolation, a built-in Class A EMC filter and low ripple/noise figures. The outputs are also fully protected against short circuits, overcurrent and overvoltage. The no load input current is particularly low (only 4mA/6mA). The RP20-A series will find many uses in applications where board space and/or board height is at a premium or in battery-powered systems where standby current is important.

Selection Guide

Part Number	Input Voltage Range [VDC]	Output Voltage [VDC]	Output Current [mA]	Input ⁽¹⁾ Current [mA]	Efficiency ⁽¹⁾ typ. [%]	Max. Capacitive Load ⁽²⁾ [μF]
RP20-123.3SA ^(3,4)	9-18	3.3	4500	1390	89	7000
RP20-1205SA ^(3,4)	9-18	5	4000	1873	89	5000
RP20-1212SA ^(3,4)	9-18	12	1670	1876	89	850
RP20-1215SA ^(3,4)	9-18	15	1330	1868	89	700
RP20-243.3SA ^(3,4)	18-36	3.3	4500	688	90	7000
RP20-2405SA ^(3,4)	18-36	5	4000	916	91	5000
RP20-2412SA ^(3,4)	18-36	12	1670	928	90	850
RP20-2415SA ^(3,4)	18-36	15	1330	913	91	700
RP20-483.3SA ^(3,4)	36-75	3.3	4500	344	90	7000
RP20-4805SA ^(3,4)	36-75	5	4000	463	90	5000
RP20-4812SA ^(3,4)	36-75	12	1670	464	90	850
RP20-4815SA ^(3,4)	36-75	15	1330	462	90	700
RP20-1212DA ^(3,4)	9-18	±12	±833	1872	89	±500
RP20-1215DA ^(3,4)	9-18	±15	±667	1853	90	±350
RP20-2412DA ^(3,4)	18-36	±12	±833	926	90	±500
RP20-2415DA ^(3,4)	18-36	±15	±667	926	90	±350
RP20-4812DA ^(3,4)	36-75	±12	±833	468	89	±500
RP20-4815DA ^(3,4)	36-75	±15	±667	463	90	±350



Notes:

- Note1: Values at nominal input voltage and full load
Note2: Test by minimum Vin and constant resistor load.



Model Numbering

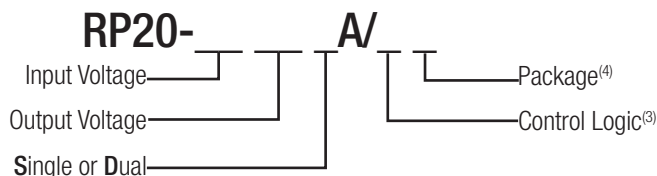

Ordering Examples

RP20-2405SA/P = 24V Input, 5V Output, Positive Logic CTRL pin and Trim pin fitted
RP20-4812DA-HC = 48V Input, ±12V Output, Heat-sink fitted

Notes:

- Note3: no suffix for standard part without Trim or CTRL
add suffix "P" for CTRL function with positive logic (1=ON, 0=OFF) and trim pin
add suffix "N" for CTRL function with negative logic (0=ON, 1=OFF) and trim pin
Note4: add suffix -HC for premounted Heat-sink and clips

UL60950-1 Certified

Specifications measured at Ta = 25°C, nominal input voltage, full load otherwise noted

BASIC CHARACTERISTICS					
Parameter	Condition		Min.	Typ.	Max.
Input Voltage Range	nom. Vin = 12V nom. Vin = 24V nom. Vin = 48V		9VDC 18VDC 36VDC	12VDC 24VDC 48VDC	18VDC 36VDC 75VDC
Under Voltage Lockout (UVLO)	Vin = 12V	DC-DC ON DC-DC OFF		8VDC	9VDC
	Vin = 24V	DC-DC ON DC-DC OFF		16VDC	18VDC
	Vin = 48V	DC-DC ON DC-DC OFF		33VDC	36VDC
Input Filter					Pi-Type
Input Reflected Ripple ⁽⁵⁾	nominal Vin and full load			30mA _{p-p}	
Input Surge Voltage	Vin = 12V, 100ms max. Vin = 24V, 100ms max. Vin = 48V, 100ms max.				25VDC 50VDC 100VDC
Start-up time	Power up				30ms
	Remote ON/OFF				30ms
Operating Frequency Range	3.3V _{out} , 5V _{out}		248kHz	275kHz	303kHz
	Others		297kHz	330kHz	363kHz
Minimum Load			0%		
Ripple and Noise	measured by 20Mhz bandwidth with a 1µF M/C X7R and a 10µF T/C	Single		75mV _{p-p}	
	measured by 20Mhz bandwidth with a 1µF M/C X7R and a 10µF T/C for each output	Dual		100mV _{p-p}	
Remote ON/OFF ⁽⁶⁾	Positive Logic	DC-DC ON DC-DC OFF	Open or 3.0V < Vr < 15V Short or 0V < Vr < 1.2V		
	Negative Logic	DC-DC ON DC-DC OFF	Short or 0V < Vr < 1.2V Open or 3.0V < Vr < 15V		
Input current of Remote pin (CTRL)				2mA	
			DC-DC ON	-0.5mA	1.0mA

Notes:

Note5: Simulated source impedance of 12µH. 12µH inductor in series with +Vin.

Note6: The ON/OFF control function can be positive or negative logic. The pin voltage is referenced to -Vin pin.

If no suffix is specified, the control pin will be omitted.

RP20-1205SA

Efficiency vs. Output Current

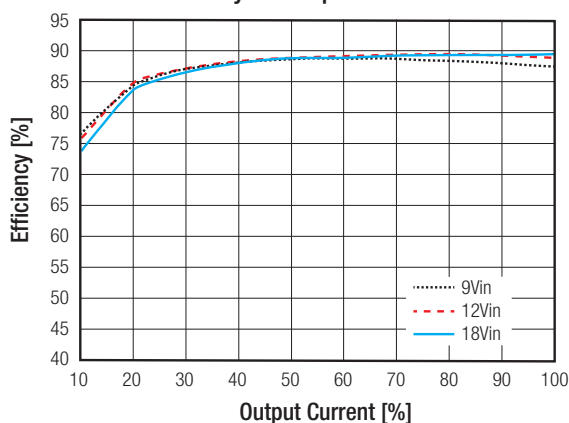

Efficiency vs. Input Voltage

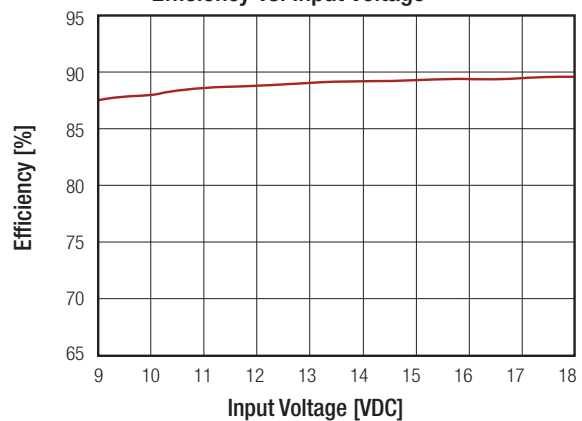

continued on next page

Specifications measured at Ta = 25°C, nominal input voltage, full load otherwise noted

RP20-2405SA

Efficiency vs. Output Current

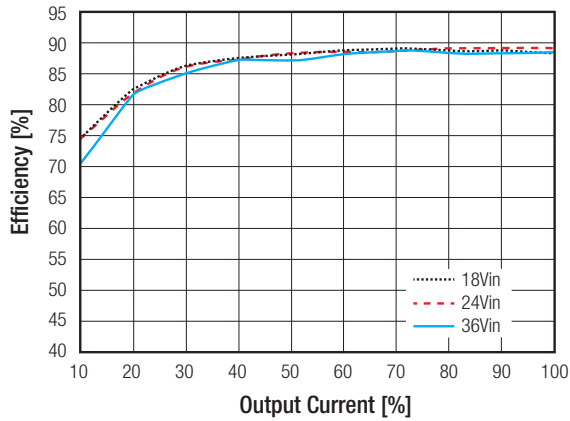

Efficiency vs. Input Voltage

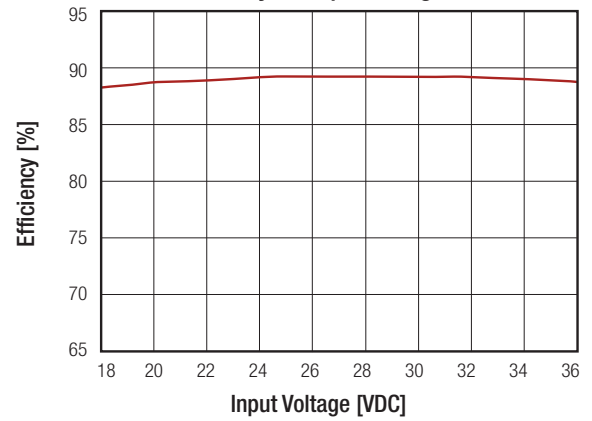

RP20-4805SA

Efficiency vs. Output Current

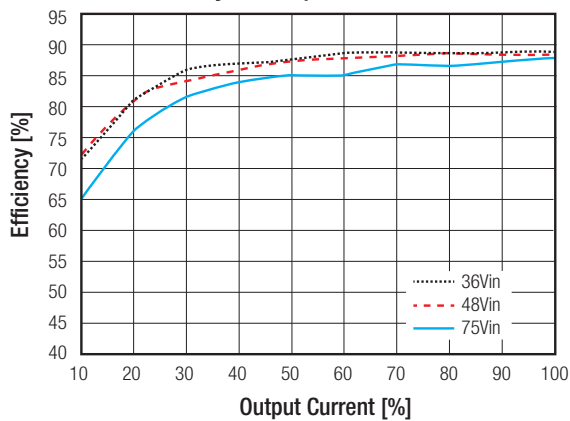

Efficiency vs. Input Voltage

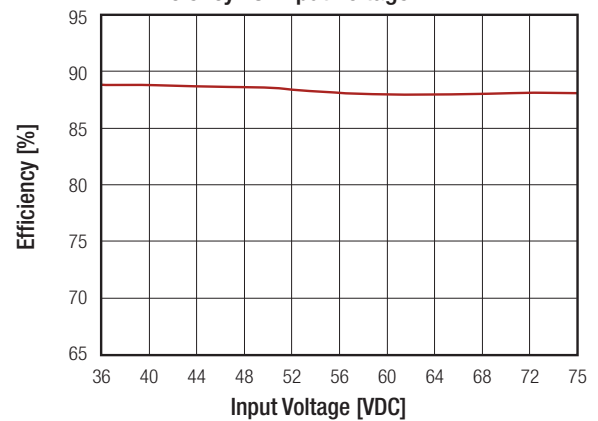

REGULATIONS

Parameter	Condition		Value
Output Voltage Accuracy			±1%
Output Trimming	Single		±10%
Line Voltage Regulation	Single		±0.2%
	Dual		±0.5%
Load Voltage Regulation	0% to 100% load	Single	±0.2%
		Dual	±1.0%
	10% load to 90% load	Single	±0.1%
		Dual	±0.8%
Cross Regulation	asymmetrical 25% <> 100% load		±5%
Transient Response recovery time	25% load step change		250µs

continued on next page

Specifications measured at $T_a = 25^\circ\text{C}$, nominal input voltage, full load otherwise noted

External Output Trimming

Output Voltage Trimming

Some single/dual output Powerline converters offer the feature of trimming the output voltage over a certain range around the nominal value by using external trim resistors. No general equation can be given for calculating the trim resistors, but the following trim tables give typical values for choosing these trimming resistors. If voltages between the given trim points are required, extrapolate between the two nearest given values to work out the resistor required or use a variable resistor to set the output voltage. Output can be externally trimmed by using the method shown below.

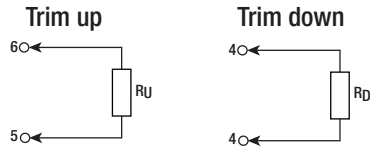

RP20-xx3.3S

Trim up	1	2	3	4	5	6	7	8	9	10	%
V _{out} =	3.333	3.366	3.399	3.432	3.465	3.498	3.531	3.564	3.597	3.63	Volts
R _U =	57.93	26.16	15.58	10.28	7.11	4.99	3.48	2.34	1.46	0.75	kOhms
Trim down	1	2	3	4	5	6	7	8	9	10	%
V _{out} =	3.267	3.234	3.201	3.168	3.135	3.102	3.069	3.036	3.003	2.97	Volts
R _D =	69.47	31.23	18.49	12.12	8.29	5.74	3.92	2.56	1.50	0.65	kOhms

RP20-xx05S

Trim up	1	2	3	4	5	6	7	8	9	10	%
V _{out} =	5.05	5.10	5.15	5.20	5.25	5.30	5.35	5.4	5.45	5.50	Volts
R _U =	36.57	16.58	9.92	6.58	4.59	3.25	2.30	1.59	1.03	0.59	kOhms
Trim down	1	2	3	4	5	6	7	8	9	10	%
V _{out} =	4.95	4.90	4.85	4.80	4.75	4.70	4.65	4.60	4.55	4.50	Volts
R _D =	45.53	20.61	12.31	8.15	5.66	4.00	2.81	1.92	1.23	0.68	kOhms

RP20-xx12S

Trim up	1	2	3	4	5	6	7	8	9	10	%
V _{out} =	12.12	12.24	12.36	12.48	12.60	12.72	12.84	12.96	13.08	13.20	Volts
R _U =	367.91	165.95	98.64	64.98	44.78	31.32	21.70	14.49	8.88	4.39	kOhms
Trim down	1	2	3	4	5	6	7	8	9	10	%
V _{out} =	11.88	11.76	11.64	11.52	11.40	11.28	11.16	11.04	10.92	10.8	Volts
R _D =	460.99	207.95	123.60	81.42	56.12	39.25	27.20	18.16	11.13	5.51	kOhms

RP20-xx15S

Trim up	1	2	3	4	5	6	7	8	9	10	%
V _{out} =	15.15	15.3	15.45	15.60	15.75	15.90	16.05	16.20	16.35	16.50	Volts
R _U =	404.18	180.59	106.06	68.80	46.44	31.53	20.88	12.90	6.69	1.72	kOhms
Trim down	1	2	3	4	5	6	7	8	9	10	%
V _{out} =	14.85	14.70	14.55	14.40	14.25	14.10	13.95	13.80	13.65	13.50	Volts
R _D =	499.82	223.41	131.27	85.20	57.56	39.14	25.97	16.10	8.42	2.282	kOhms

continued on next page

Specifications measured at Ta = 25°C, nominal input voltage, full load otherwise noted

Dual Output Voltage Trim Tables

RP20-xx12D

Trim up	1	2	3	4	5	6	7	8	9	10	%
Vout =	24.24	24.48	24.72	24.96	25.20	25.44	25.68	25.92	26.16	26.40	Volts
R _U =	218.21	98.10	58.07	38.05	26.04	18.03	12.32	8.03	4.69	2.02	kOhms
Trim down	1	2	3	4	5	6	7	8	9	10	%
Vout =	23.76	23.52	23.28	23.04	22.80	22.56	22.32	22.08	21.84	21.6	Volts
R _D =	273.44	123.02	72.87	47.80	32.76	22.73	15.57	10.20	6.02	2.67	kOhms

RP20-xx15D

Trim up	1	2	3	4	5	6	7	8	9	10	%
Vout =	30.30	30.60	30.90	31.20	31.50	31.80	32.10	32.40	32.70	33.00	Volts
R _U =	268.29	120.64	71.43	46.82	32.06	22.21	15.10	9.91	5.81	2.53	kOhms
Trim down	1	2	3	4	5	6	7	8	9	10	%
Vout =	29.70	29.40	29.10	28.80	28.50	28.20	27.90	27.60	27.30	27.00	Volts
R _D =	337.71	152.02	90.13	59.18	40.61	28.23	19.39	12.76	7.60	3.47	kOhms

PROTECTIONS

Parameter	Condition	Value
Short Circuit Protection (SCP)		continuous, automatic recovery
Over Voltage Protection (OVP)	Zener Diode Clamp	3.3Vout 5Vout 12Vout 15Vout
		3.7VDC - 5.4VDC 5.6VDC - 7.0VDC 13.5VDC - 19.6VDC 16.8VDC - 20.5VDC
Over Load Protection (OLP)	% Iout rated; Hiccup mode	150% typ.
Isolation Voltage	I/P to O/P I/P to O/P to case	1.6kVDC/1 minute 1.0kVDC/1 minute
Isolation Resistance	500 VDC	1GΩ min.
Isolation Capacitance		1500pF max.

Notes:

Note7: This power module is not internally fused. An input line fuse must always be used.

Specifications measured at Ta = 25°C, nominal input voltage, full load otherwise noted

ENVIRONMENTAL		
Parameter	Condition	Value
Operating Temperature Range	without derating	-40°C to +70°C
	with derating	-40°C to +102°C
Maximum Case Temperature		+105°C
Operating Humidity		5% - 95% RH
Temperature Coefficient		±0.02%/°C max.
Thermal Impedance	Natural convection (20LFM)	17,6°C/Watt
	Natural convection (20LFM) with Heat-sink	14,8°C/Watt
Thermal Shock		MIL-STD-810F
Vibration		MIL-STD-810F
MTBF	MIL-HDBK-217F	1477 x 10 ³ hours
	Bellcore TR-NWT-000332 ⁽⁸⁾	1766 x 10 ³ hours

Derating Graph⁽¹⁰⁾

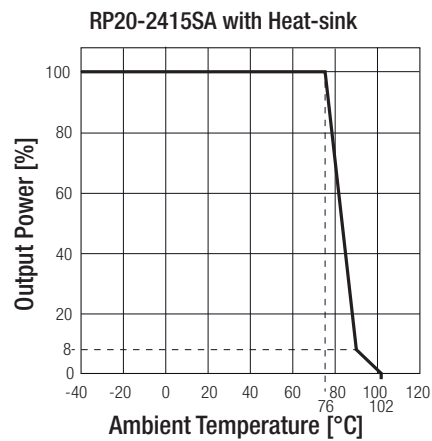
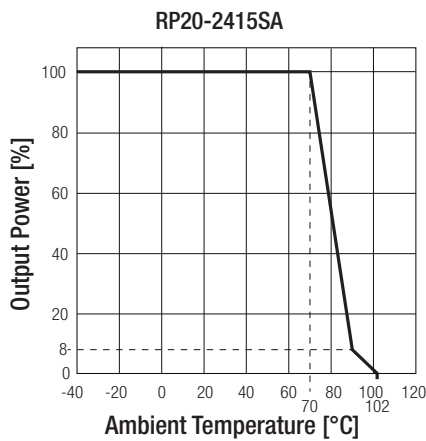

Notes:

- Note8: BELLCORE TR-NWT-000332. Case I: 50% Stress, Temperature at 40°C. MIL-HDBK 217F Notice 2. Ta = 25°C, full load, (Ground, Benign, controlled environment).
- Note9: Derating graphs are valid only for the shown part numbers. If you need detailed derating-information about a part number not shown here please contact our technical support service at techsupportAT@recom-power.com

SAFETY AND CERTIFICATIONS		
Certificate Type (Safety)	Condition	Standard
UL General Safety	E196683	UL60950-1 1st Ed.: 2003 C22.2 No. 60950 1st. Ed.: 2003
EMC Compliance	Condition	Standard / Criterion
EMI Standard ⁽¹⁰⁾	with external filter	EN55022, Class A, Class B
ESD	Air ±8kV and Contact ±6kV	EN61000-4-2, Criteria A
Radiated Immunity	10 V/m	EN61000-4-3, Criteria A
Fast Transient ⁽¹¹⁾	±2kV	EN61000-4-4, Criteria A
Surge ⁽¹¹⁾	±2kV	EN61000-4-5, Criteria A
Conducted Immunity	10 Vr.m.s	EN61000-4-6, Criteria A

continued on next page

Specifications measured at Ta = 25°C, nominal input voltage, full load otherwise noted

Notes:

Note10: The standard modules meet EMI Class A or Class B with external components, see filter suggestions below.

Note11: An external input filter capacitor is required if the module has to meet EN61000-4-4, EN61000-4-5. The filter capacitor Recom suggests: Nippon chemi-con KY series, 220µF/100V.

EMI Filtering Class B

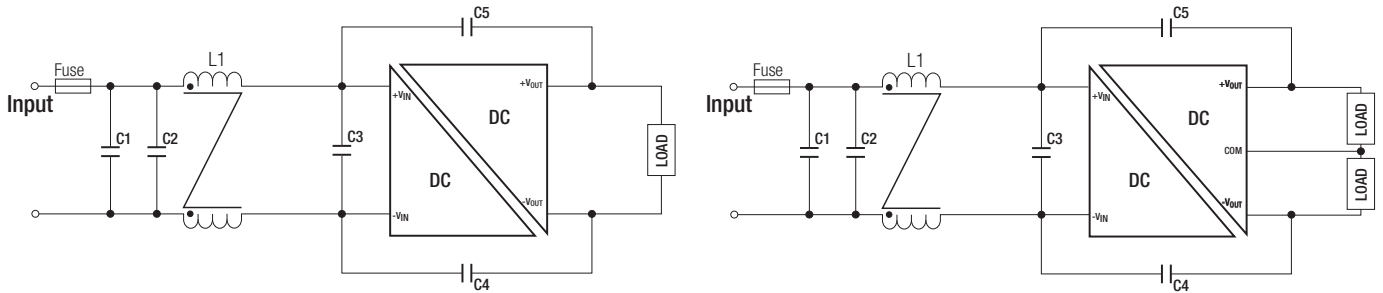

MODEL	C1	C2	C3	C4/C5	L1
RP20-12xxSA	4.7µF/25V 1812 MLCC	N/A	N/A	470pF/2kV 1808 MLCC	CMC: 325µH ref.: WE 744290321 ref.: CMC-06
RP20-24xxSA	4.7µF/25V 1812 MLCC	N/A	N/A	470pF/2kV 1808 MLCC	CMC: 325µH ref.: WE 744290321 ref.: CMC-06
RP20-48xxSA	2.2µF/100V 1812 MLCC	2.2µF/100V 1812 MLCC	2.2µF/100V 1812 MLCC	470pF/2kV 1808 MLCC	CMC: 325µH ref.: WE 744290321 ref.: CMC-06

DIMENSIONS and PHYSICAL CHARACTERISTICS		
Parameter	Type	Value
Material	Case	Nickel coated copper
	Base	FR4 PCB
	Potting	Silicone (UL94 V-0)
Packaging Dimension (LxWxH)	without Heat-sink	25.4 x 25.4 x 9.9mm
	with Heat-sink	31.4 x 25.4 x 16.5mm
Packaging Weight	without Heat-sink	15g
	with Heat-sink	21.44g

continued on next page

Specifications measured at Ta = 25°C, nominal input voltage, full load otherwise noted

Dimension Drawing (mm)

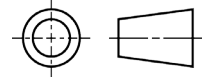
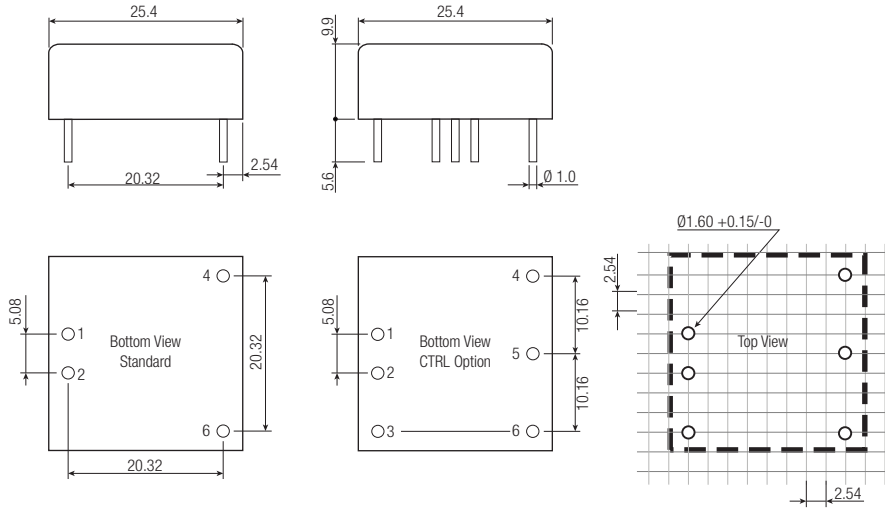

Dimension Drawing (mm) with Heat-sink

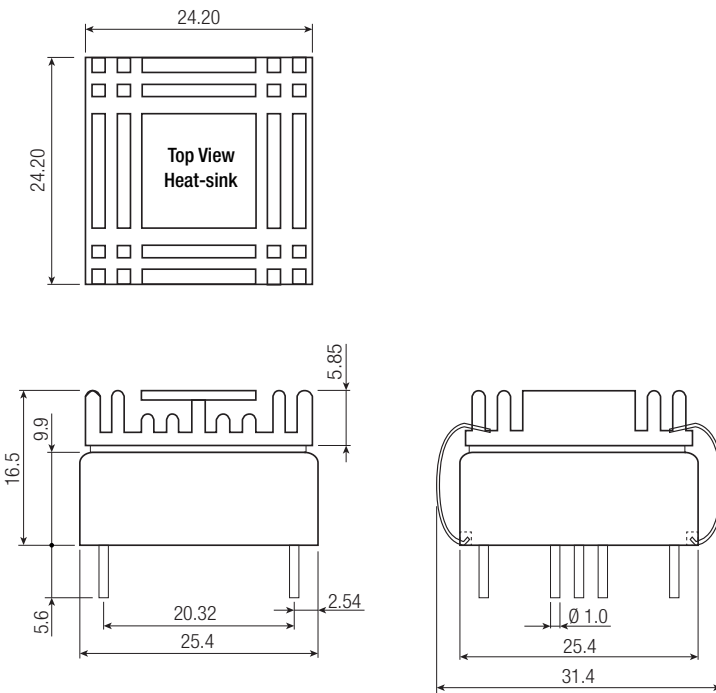

Pin Connections

Pin #	Single	Dual
1	+Vin	+Vin
2	-Vin	-Vin
3	CTRL	CTRL
4	+Vout	+Vout
5	Trim	Com
6	-Vout	-Vout

Pin Pitch Tolerance ±0.25mm
Pin dimension tolerance ±0.1mm
XX.X ± 0.5mm
XX.XX ± 0.25mm

PACKAGING INFORMATION

Parameter	Type	Value
Packaging Quantity	without Heat-sink Tube with Heat-sink Tray	8pcs. 20pcs.
Storage Temperature Range		-55°C to +125°C
Storage Humidity		5% - 95% RH

The product information and specifications are subject to change without prior notice. RECOM products are not authorized for use in safety-critical applications (such as life support) without RECOM's explicit written consent. A safety-critical application is defined as an application where a failure of a RECOM product may reasonably be expected to endanger or cause loss of life, inflict bodily harm or damage property. The buyer shall indemnify and hold harmless RECOM, its affiliated companies and its representatives against any damage claims in connection with the unauthorized use of RECOM products in such safety-critical applications.