

Technology to Inspire Innovation

# ***Preferred Connector Products***

# **JAE**

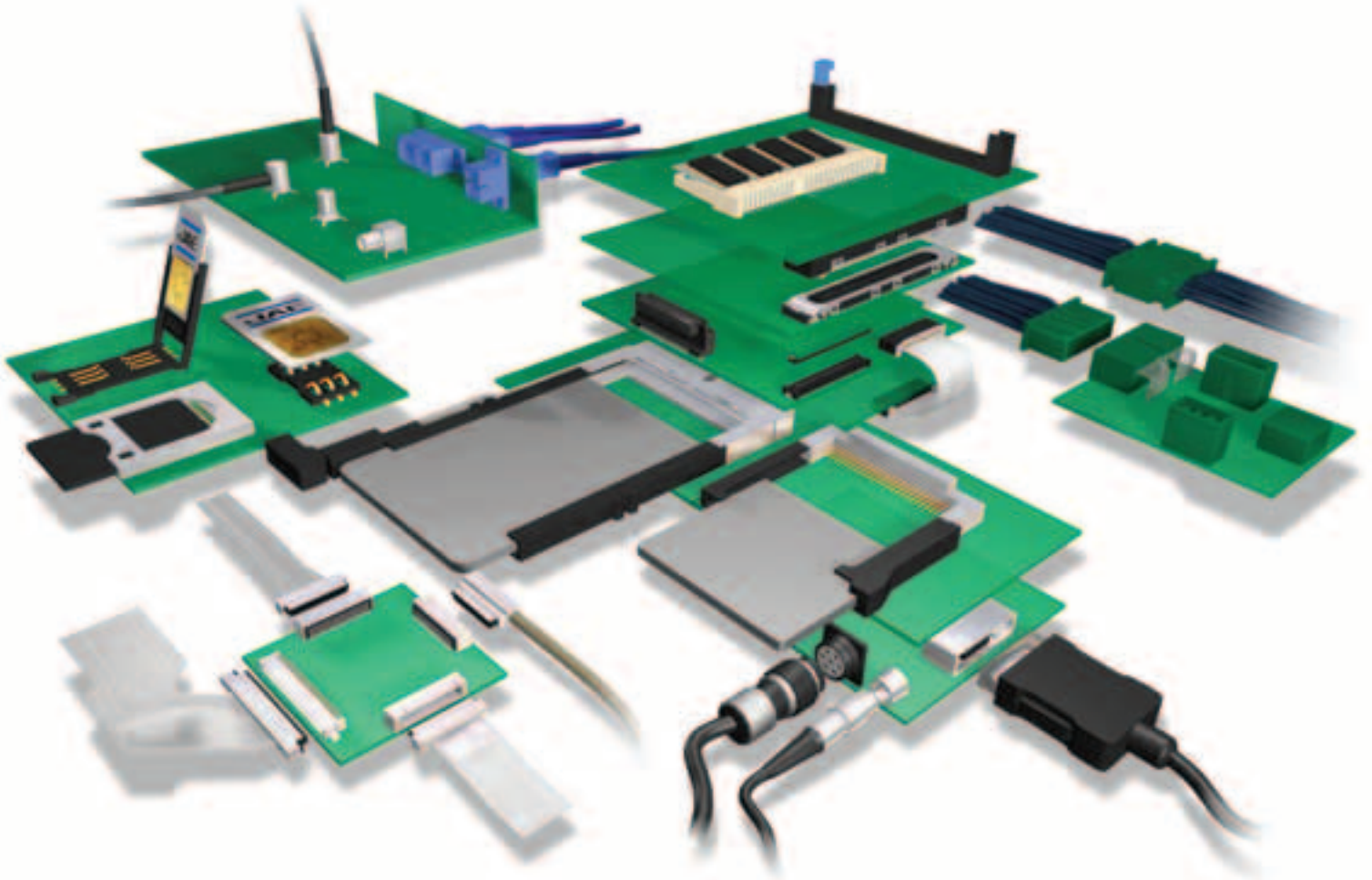

***JAE Electronics, Inc.***

***For Additional Information Visit [www.jae-connector.com](http://www.jae-connector.com)***

**J**apan Aviation Electronics Industry, Ltd. (JAE) is an international manufacturer and supplier of electronic components and systems. For over four decades, JAE has provided the electronics industry with solutions to complex design requirements. Since its founding, the Company has strived to contribute to society through market-driven, technology-based global business operations under the philosophy: "Technology to Inspire Innovation."

With worldwide and world-class manufacturing certified to ISO 9001 and QS 9000, JAE has made the commitment to meet the global requirements of our customer. In addition to a network of state of the art manufacturing facilities, JAE has technical service offices located around the world, staffed with experts in connector design and application.

This catalog contains a select overview of JAE Connector Products. For in-depth information on our complete product line, and information on new developments, visit JAE's online catalog at [www.jae-connector.com](http://www.jae-connector.com).

Innovative design, quality oriented manufacturing, commitment to our customers and sensitivity to the environment assures JAE's leadership position in the 21<sup>st</sup> century.

## Table of Contents

Product Series	Contact Spacing	Pages
<b>SOCKETS/MEMORY PRODUCTS</b>		
PCMCIA		
JC22.....	1.27mm (.050").....	5
COMPACT FLASH		
JC26C2.....	1.27mm (.050").....	6 - 7
JC26E.....	1.27mm (.050").....	8
JC26F.....	1.27mm (.050").....	9
PCI EXPRESS MINI CARD		
MM60.....	0.8mm (.031").....	10
EXPRESSCARD		
PX10/11.....	1.0mm (.039").....	11 - 12
PX20/22.....	1.0mm (.039") / 0.635mm (.025").....	13 - 14
SMART/SIM CARD		
SF2.....	2.54mm (.100").....	15
SF3.....	2.54mm (.100").....	16
SF6.....	2.54mm (.100").....	17
SF7.....	2.54mm (.100").....	18
SF7 (Slim).....	2.54mm (.100").....	19
SF9.....	2.54mm (.100").....	20
SECURE DIGITAL CARD		
SG5.....	2.50mm (.098").....	21
MINI SECURE DIGITAL CARD (SD)		
ST4.....	1.1mm (.043").....	22
SC1.....	2.50mm (.098").....	23
MICRO SD/TRANSFLASH™		
ST1.....	1.1mm (.043").....	24
ST2.....	1.1mm (.043").....	25

## **BOARD-TO-BOARD CONNECTOR PRODUCTS**

<b>BOARD-TO-BOARD</b>		
AA03.....	0.40mm (.020").....	26
WA6.....	0.40mm (.020").....	27
WH1.....	0.40mm (.020").....	28
AA01A.....	0.50mm (.020").....	29
IL-312.....	0.50mm (.020").....	30
WR.....	0.50mm (.020").....	31 - 32
WB3.....	0.50mm (.020").....	33
IL-WX.....	0.80mm (.031").....	34
KX14/15.....	0.80mm (.031").....	35 - 36
PM1.....	0.80mm (.031").....	37
WM1.....	1.00mm (.039").....	38
WM2.....	1.00mm (.039").....	39
TX24/TX25.....	1.27mm (.050").....	40

## Table of Contents

Product Series	Contact Spacing	Pages
<b>BOARD-TO-BOARD CONNECTOR PRODUCTS</b>		
WIRE-TO-BOARD		
PCB-TO-FPC/FFC		
FB3.....	0.30mm (.012").....	41
FB5.....	0.30mm (.012").....	42
FB6.....	0.30mm (.012").....	43
FF02.....	0.30mm (.012").....	44
FF02S.....	0.30mm (.012").....	45
FB8.....	0.30mm (.012").....	46
FA5.....	0.50mm (.020").....	47
FF03.....	0.50mm (.020").....	48
IL-FPR.....	0.50mm (.020").....	49
PCB-TO-CABLE/FPC		
FI-J.....	0.40mm (.016").....	50 - 51
FI-R.....	0.50mm (.020").....	52 - 53
FI-X.....	1.00mm (.039").....	54 - 55
FI.....	1.25mm (.049").....	56 - 58
PCB-TO-CABLE		
DX2/3.....	0.80mm (.031").....	59
FI-E.....	1.00mm (.039").....	60 - 61
CN10.....		62 - 63
CV10.....		64
IL-Z.....	1.25mm (.049").....	65 - 66
IL-S.....	2.00mm (.079").....	67 - 68
LY.....	2.00mm (.079").....	69
KD10/20.....	2.00mm (.079").....	70
IL-G.....	2.50mm (.098").....	71
<b>INPUT/OUTPUT CONNECTOR PRODUCTS</b>		
PCB-TO-CABLE		
DD1.....	0.50mm (.020").....	72 - 73
DD2.....	0.50mm (.020").....	74 - 75
DG1.....	0.50mm (.020").....	76
RA1.....	0.50mm (.020").....	77
RC1.....	0.50mm (.020").....	78
DA1.....	0.60mm (.024").....	79
DE1.....	1.27mm (.050").....	80
TX20A.....	1.27mm (.050").....	81
DV2.....	1.905mm (.075").....	82 - 84
CIRCULAR		
JN1.....		85 - 86
JN2.....		87 - 88
JB5.....		89





# IL-AG9 SERIES CONNECTORS

2.50mm (.098") Contact Spacing, Compact Relay Connector for Vehicles

1) 2 contact socket housing (IL-AG9-2S-S3C1)

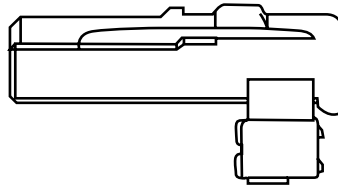
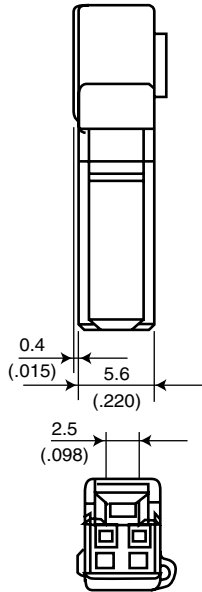

(for reference)

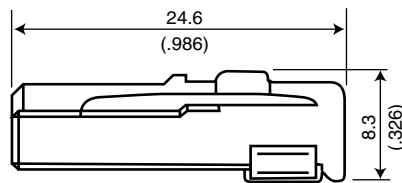

2) 2 contact relay pin housing (IL-AG9-2P-S3C1)

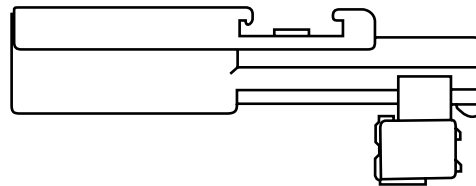
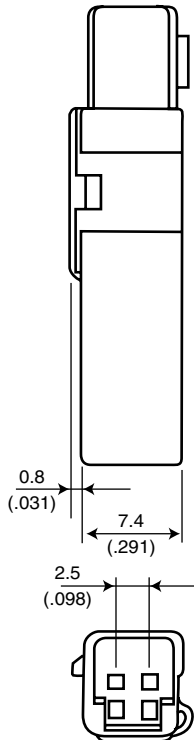

(for reference)

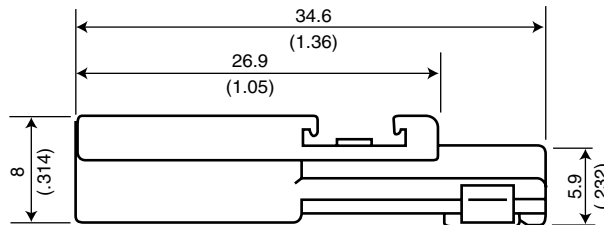

# IL-AG9 SERIES CONNECTORS

## 2.50mm (.098") Contact Spacing, Compact Relay Connector for Vehicles

3) 3 contact socket housing (IL-AG9-3S-S3C1)

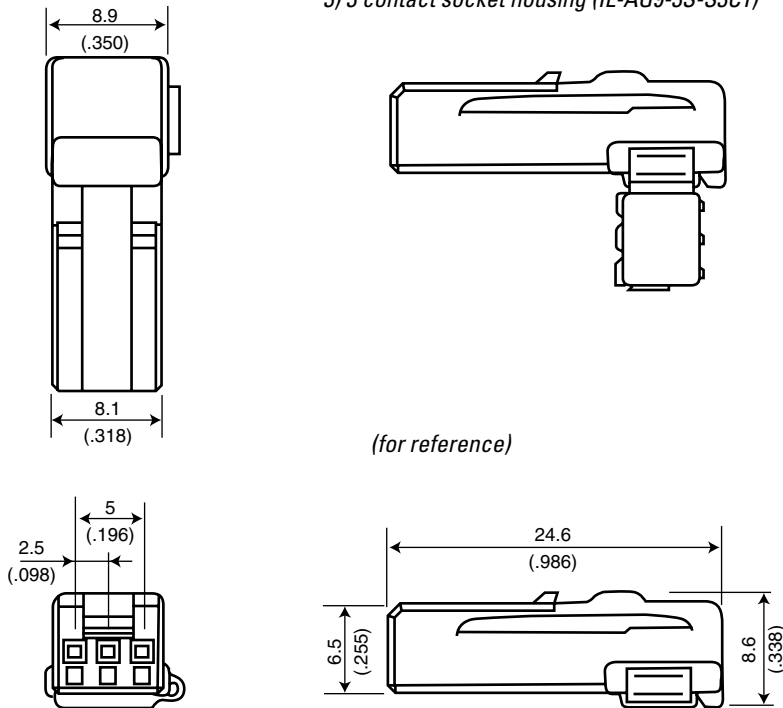

4) 3 contact relay pin housing (IL-AG9-3P-S3C1)

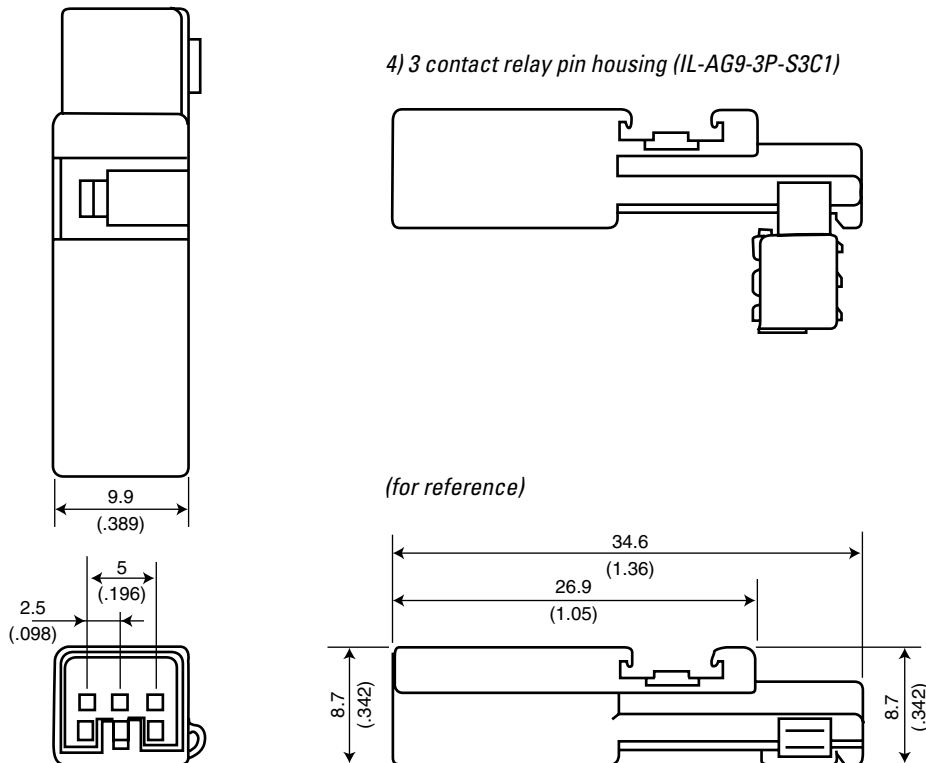

Dimensions and specifications subject to change without notice.



Technology to Inspire Innovation

# JAE

***“Building Technologies  
to Connect Your World”***



## **Japan Aviation Electronics Industry, Limited**

1-19, Aobadai 3-chome, Meguro-ku  
Tokyo 153-8539, Japan  
Telephone: 03-3780-2736  
Fax: 03-3780-2883

## **JAE Electronics, Inc.**

142 Technology Drive, Suite 100  
Irvine, California 92618-2430, U.S.A.  
Telephone: 949-753-2600  
Fax: 949-753-2699  
800-523-7278 Toll free in the U.S.A.

## **JAE Europe**

Coliseum Business Centre  
Riverside Way, Camberley  
Surrey, GU15 3YL, England  
Telephone: 44-1276-404000  
Fax: 44-1276-404010

## **JAE Taiwan, Ltd.**

4F-1, No. 88, Chung Hsiao E. Rd.  
Sec. 2, Taipei, Taiwan, R.O.C.  
Telephone: 886-2-2396-7676  
Fax: 886-2-2392-5929

## **JAE Hong Kong, Ltd.**

Suites 1407-11, 14/F, Tower 2, The Gateway,  
25 Canton Road, Tsimshatsui, Kowloon, Hong Kong  
Telephone: 852-2723-7782  
Fax: 852-2723-9028

## **JAE Korea, Inc.**

1602, Korea City Air Tower  
159-9 Samsung-Dong, Kangnam-ku  
Seoul, 135-973, Korea  
Telephone: 82-2-551-8959  
Fax: 82-2-551-8958

## **JAE Philippines, Inc.**

PEZA Zone, Gateway Business Park, Javalera  
General Trias, 4107 Cavite, Philippines  
Telephone: 63-46-433-0285  
Fax: 63-46-433-0287

## **JAE Singapore Pte., Ltd.**

33 Tannery Lane, #02-01 Hoesteel  
Industrial Building  
Singapore 347789  
Telephone: 65-6748-1332  
Fax: 65-6748-2920

## **JAE Shanghai Co., Ltd.**

RM 1407, Shanghai Mart 2299 Yanan Rd.  
West Shanghai 200336 P.R.C.  
Telephone: 86-21-6236-0322  
Fax: 86-21-6236-1292