

SOT-227 Power Module Insulated Standard Recovery Rectifier, 160 A



SOT-227

FEATURES

- Two fully independent diodes
- Fully insulated package
- High voltage rectifiers optimized for very low forward voltage drop
- Industry standard outline
- UL pending
- Material categorization: for definitions of compliance please see www.vishay.com/doc?99912

RoHS
COMPLIANT

DESCRIPTION / APPLICATIONS

These devices are intended for use in main rectification. Single or three phase bridge.

PRIMARY CHARACTERISTICS

$I_{F(AV)}$ per module	160 A, $T_C = 101\text{ }^\circ\text{C}$
V_{FM} typical at 100 A	1.16 V
Type	Modules - diode, high voltage
Package	SOT-227
Circuit configuration	Two separate diodes, parallel pin-out

MAJOR RATINGS AND CHARACTERISTICS

SYMBOL	CHARACTERISTICS	VALUES	UNITS
$I_{F(AV)}$	90 °C	91	A
$I_{F(RMS)}$		138	
I_{FSM}	50 Hz	940	
	60 Hz	985	
I^2t	50 Hz	4420	A ² s
	60 Hz	4015	
$I^2\sqrt{t}$		44 180	A ² √s
V_{RRM}		1200	V
T_J		-55 to +150	°C

ELECTRICAL SPECIFICATIONS
VOLTAGE RATINGS

TYPE NUMBER	VOLTAGE CODE	V_{RRM} , MAXIMUM REPETITIVE PEAK REVERSE VOLTAGE V	V_{RSM} , MAXIMUM NON-REPETITIVE PEAK REVERSE VOLTAGE V	I_{RRM} TYPICAL AT 150 °C mA
VS-RA160FA120	120	1200	1300	1.0



FORWARD CONDUCTION					
PARAMETER	SYMBOL	TEST CONDITIONS		VALUES	UNITS
Maximum average forward current at case temperature per leg	$I_{F(AV)}$	180° conduction, half sine wave, 90 °C		91	A
Maximum RMS forward current per leg	$I_{F(RMS)}$	DC at 101 °C case temperature		138	A
Maximum peak, one-cycle forward, non-repetitive surge current per leg	I_{FSM}	t = 10 ms	No voltage reapplied	940	
		t = 8.3 ms		985	
		t = 10 ms	100 % V_{RRM} reapplied	790	
		t = 8.3 ms		825	
Maximum I^2t for fusing per leg	I^2t	t = 10 ms	No voltage reapplied	4420	A ² s
		t = 8.3 ms		4015	
		t = 10 ms	100 % V_{RRM} reapplied	3125	
		t = 8.3 ms		2840	
Maximum $I^2\sqrt{t}$ for fusing per leg	$I^2\sqrt{t}$	t = 0.1 ms to 10 ms, no voltage reapplied		44 180	A ² √s
Low level of threshold voltage per leg	$V_{F(TO)1}$	$(16.7 \% \times \pi \times I_{F(AV)}) < I < \pi \times I_{F(AV)}, T_J = T_J \text{ maximum}$		0.80	V
Low level value of forward slope resistance	r_{f1}			4.32	mΩ
High level of threshold voltage per leg	$V_{F(TO)2}$	$(I > \pi \times I_{F(AV)}), T_J = T_J \text{ maximum}$		0.93	V
High level value of forward slope resistance	r_{f2}			4.14	mΩ
Maximum forward voltage drop per leg	V_{FM}	$I_{FM} = 100 \text{ A}, T_J = 25 \text{ °C}$		1.27	V
		$I_{FM} = 100 \text{ A}, T_J = 150 \text{ °C}$		1.22	

BLOCKING					
PARAMETER	SYMBOL	TEST CONDITIONS		VALUES	UNITS
Maximum peak reverse leakage current per leg	I_{RRM}	$T_J = 25 \text{ °C}$		150	μA
		$T_J = 150 \text{ °C}$		1.5	mA
RMS insulation voltage	V_{INS}	$T_J = 25 \text{ °C}$, any terminal to case, t = 1 minute		2500	V

THERMAL - MECHANICAL SPECIFICATIONS						
PARAMETER	SYMBOL	MIN.	TYP.	MAX.	UNITS	
Thermal resistance, junction to case	per leg	-	-	0.26	°C/W	
	per module	-	-	0.13		
Thermal resistance, case to heatsink	per module	-	0.1	-		
Weight		-	30	-	g	
Mounting torque to terminal		-	-	1.1 (9.7)	Nm (lbf. in)	
Mounting torque to heatsink		-	-	1.8 (15.9)	Nm (lbf. in)	
Case style		SOT-227				

ΔR CONDUCTION PER JUNCTION											
DEVICE	SINE HALF WAVE CONDUCTION					RECTANGULAR WAVE CONDUCTION					UNITS
	180°	120°	90°	60°	30°	180°	120°	90°	60°	30°	
VS-RA160FA120	0.109	0.122	0.149	0.213	0.355	0.069	0.119	0.159	0.223	0.358	°C/W

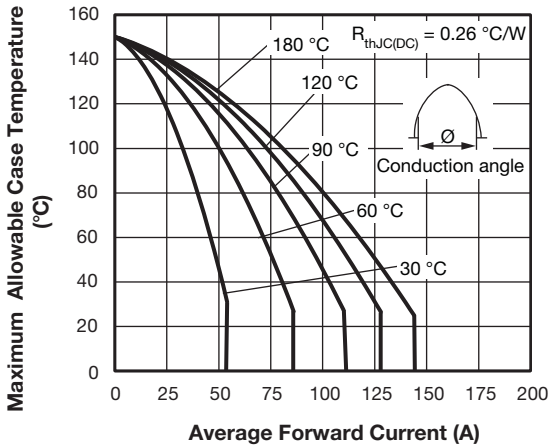

Fig. 1 - Current Ratings Characteristics (A)

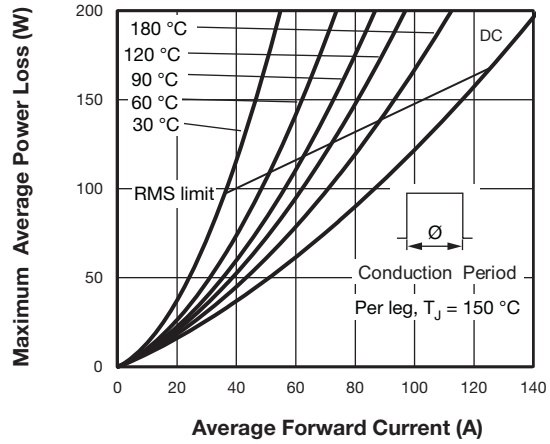

Fig. 4 - Forward Power Loss Characteristics

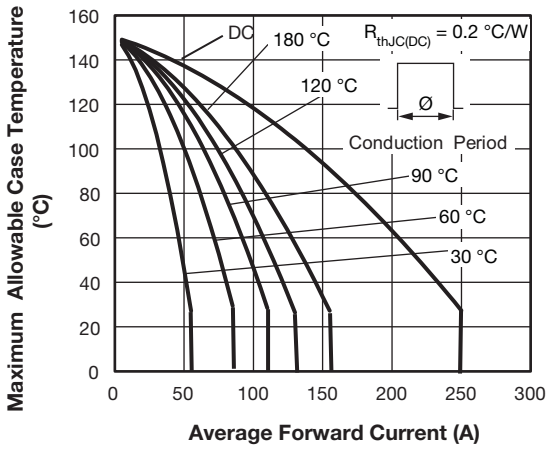

Fig. 2 - Current Ratings Characteristics (A)

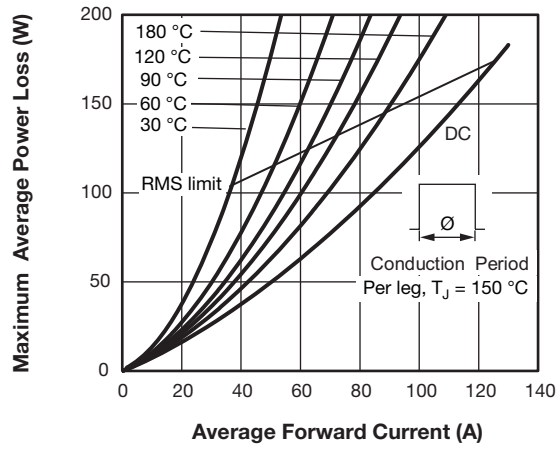

Fig. 5 - Forward Power Loss Characteristics

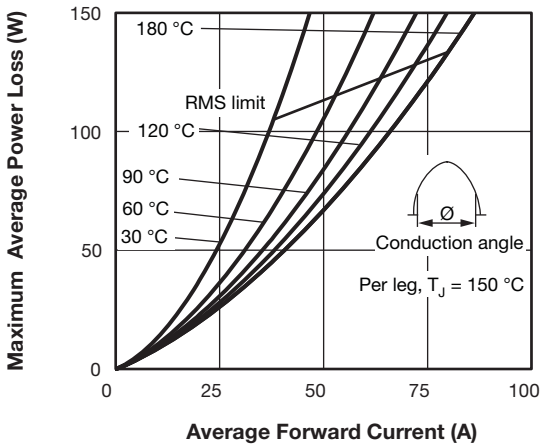

Fig. 3 - Current Ratings Characteristics (A)

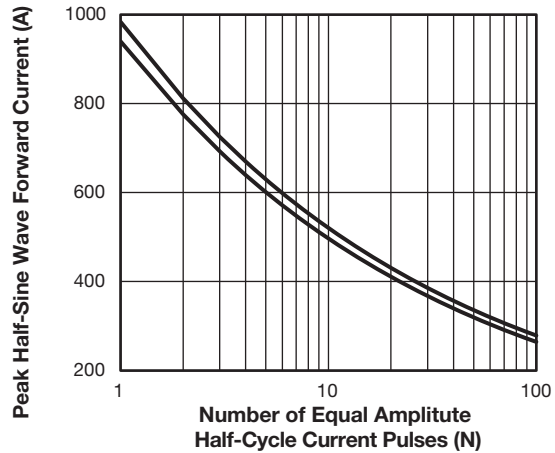

Fig. 6 - Maximum Non-Repetitive Surge Current

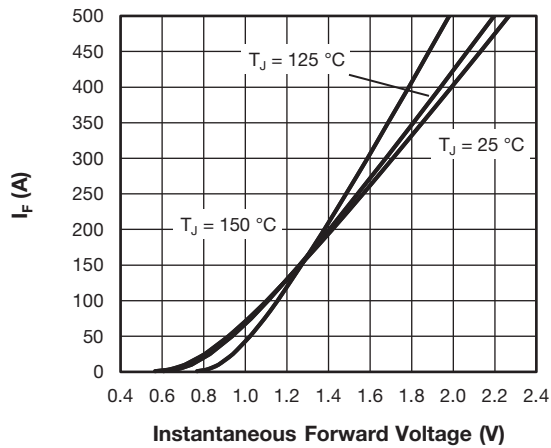

Fig. 7 - Typical Forward Voltage Characteristics

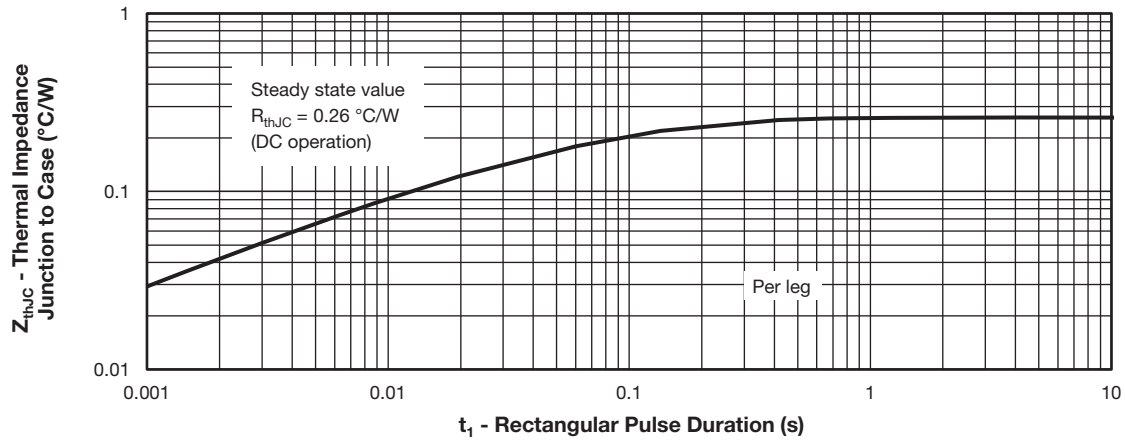

Fig. 8 - Thermal Impedance Z_{thJC} Characteristics

ORDERING INFORMATION TABLE

Device code	VS-	R	A	160	F	A	120
	①	②	③	④	⑤	⑥	⑦

- 1** - Vishay Semiconductors product
- 2** - Standard recovery diode
- 3** - Present silicon generation
- 4** - Current rating (160 = 160 A)
- 5** - Circuit configuration (2 separate diodes, parallel pin-out)
- 6** - Package indicator (SOT-227 standard insulated base)
- 7** - Voltage rating (120 = 1200 V)



CIRCUIT CONFIGURATION		
CIRCUIT	CIRCUIT CONFIGURATION CODE	CIRCUIT DRAWING
Two separate diodes, parallel pin-out	F	<p>The circuit drawing shows two diodes connected in parallel. The anodes are connected to pins 1 and 2, and the cathodes are connected to pins 3 and 4. The lead assignment diagram shows the physical layout of the diodes on the package with pins 1, 2, 3, and 4 labeled.</p>

LINKS TO RELATED DOCUMENTS	
Dimensions	www.vishay.com/doc?95423
Packaging information	www.vishay.com/doc?95425



SOT-227 Generation II

DIMENSIONS in millimeters (inches)

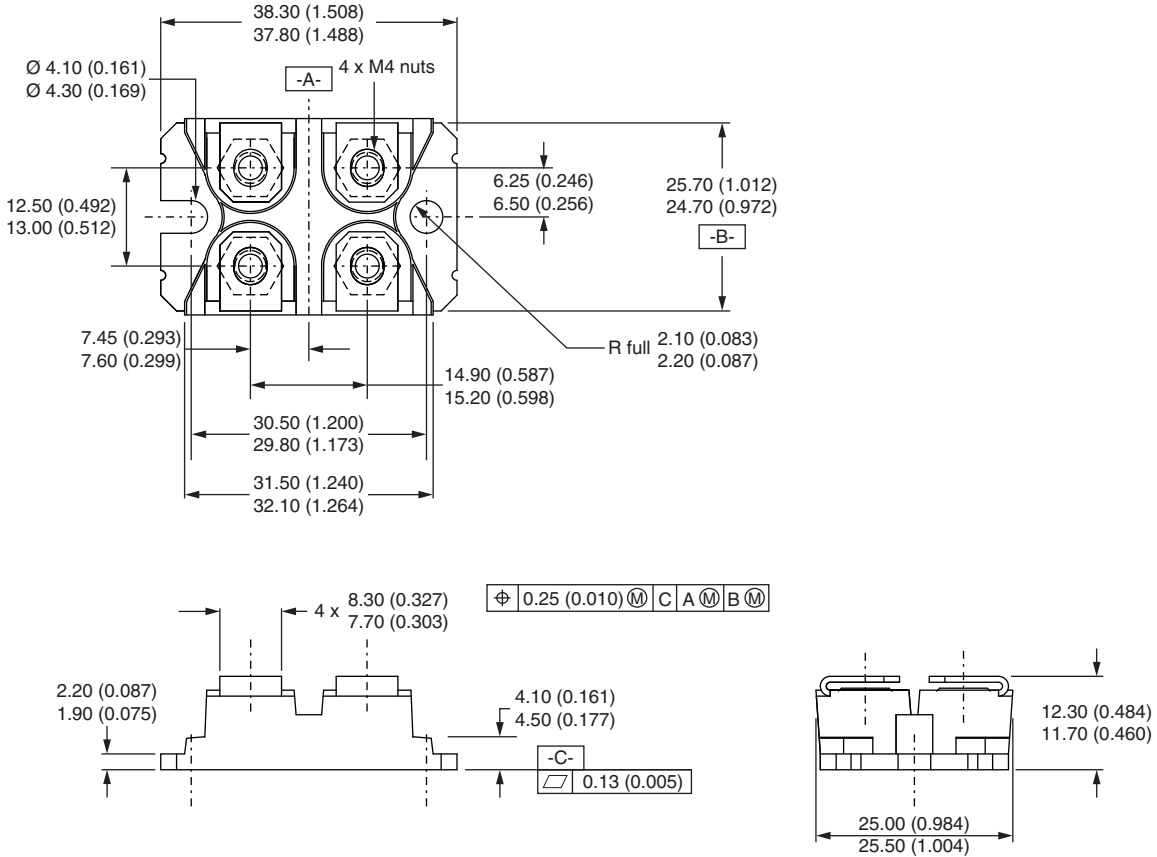

Note

- Controlling dimension: millimeter



Disclaimer

ALL PRODUCT, PRODUCT SPECIFICATIONS AND DATA ARE SUBJECT TO CHANGE WITHOUT NOTICE TO IMPROVE RELIABILITY, FUNCTION OR DESIGN OR OTHERWISE.

Vishay Intertechnology, Inc., its affiliates, agents, and employees, and all persons acting on its or their behalf (collectively, "Vishay"), disclaim any and all liability for any errors, inaccuracies or incompleteness contained in any datasheet or in any other disclosure relating to any product.

Vishay makes no warranty, representation or guarantee regarding the suitability of the products for any particular purpose or the continuing production of any product. To the maximum extent permitted by applicable law, Vishay disclaims (i) any and all liability arising out of the application or use of any product, (ii) any and all liability, including without limitation special, consequential or incidental damages, and (iii) any and all implied warranties, including warranties of fitness for particular purpose, non-infringement and merchantability.

Statements regarding the suitability of products for certain types of applications are based on Vishay's knowledge of typical requirements that are often placed on Vishay products in generic applications. Such statements are not binding statements about the suitability of products for a particular application. It is the customer's responsibility to validate that a particular product with the properties described in the product specification is suitable for use in a particular application. Parameters provided in datasheets and / or specifications may vary in different applications and performance may vary over time. All operating parameters, including typical parameters, must be validated for each customer application by the customer's technical experts. Product specifications do not expand or otherwise modify Vishay's terms and conditions of purchase, including but not limited to the warranty expressed therein.

Except as expressly indicated in writing, Vishay products are not designed for use in medical, life-saving, or life-sustaining applications or for any other application in which the failure of the Vishay product could result in personal injury or death. Customers using or selling Vishay products not expressly indicated for use in such applications do so at their own risk. Please contact authorized Vishay personnel to obtain written terms and conditions regarding products designed for such applications.

No license, express or implied, by estoppel or otherwise, to any intellectual property rights is granted by this document or by any conduct of Vishay. Product names and markings noted herein may be trademarks of their respective owners.