

SERIES: HSE-B18X-035H | **DESCRIPTION:** HEAT SINK

FEATURES

- TO-218 package
- placement pins for secure PCB attachment
- round hole for component attachment
- multiple available cut lengths



MODEL

	length (mm)	thermal resistance ¹				power dissipation ¹ @ 75°C ΔT, nat conv (W)
		@ 75°C ΔT, nat conv (°C/W)	@ 1 W, nat conv (°C/W)	@ 1 W, 200 LFM (°C/W)	@ 1 W, 400 LFM (°C/W)	
HSE-B18254-035H	25.4	9.26	13.52	3.09	2.86	8.10
HSE-B18317-035H	31.75	7.65	10.96	3.63	2.80	9.80
HSE-B18381-035H	38.1	6.25	8.34	3.52	2.48	12.00
HSE-B18508-035H	50.8	5.86	8.63	2.98	2.21	12.80
HSE-B18635-035H	63.5	4.49	6.61	2.24	1.22	16.70

Note: 1. See performance curves for full thermal resistance details.
2. Custom cut to length options available. Thermal data not available on custom lengths.

PERFORMANCE CURVES

HSE-B18254-035H

Power (W)	Heatsink Temperature Rise Above Ambient (ΔT = T _{hs} - T _a) (°C)		
	Natural Conv.	200 LFM	400 LFM
0	0	0	0
1	13.52	3.09	2.86
2	24.58	6.19	4.94
3	33.71	9.47	7.42
4	42.65	12.64	9.60
5	51.54	15.85	12.11
6	58.98	18.94	14.54
7	67.25	22.34	16.84
8	74.76	25.54	19.31
9	82.16	28.87	21.66
10	89.43	31.89	23.95

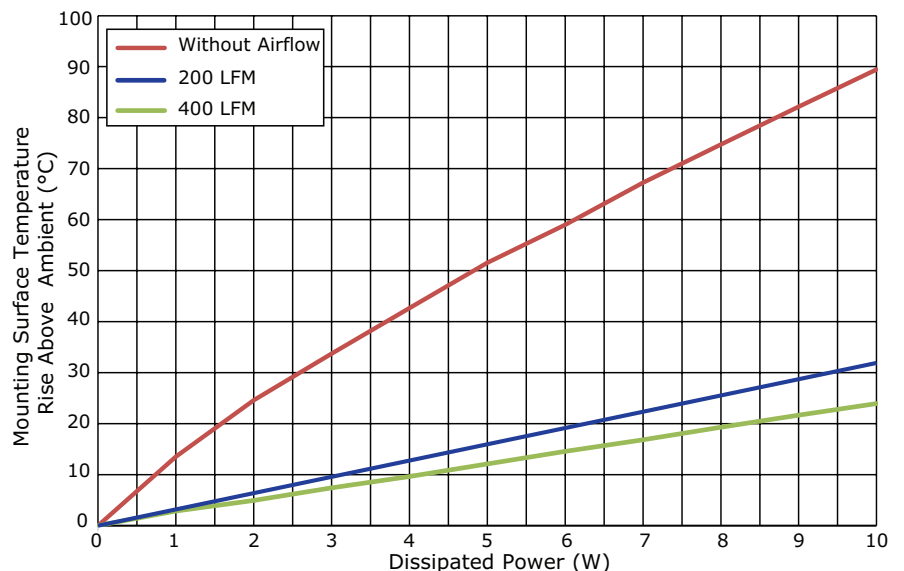

T_{hs}: "hot spot" temperature measured on the heatsink
T_a: ambient temperature

PERFORMANCE CURVES (CONTINUED)

HSE-B18317-035H

Power (W)	Heatsink Temperature Rise Above Ambient ($\Delta T = T_{hs} - T_a$) (°C)		
	Natural Conv.	200 LFM	400 LFM
0	0	0	0
1	10.96	3.63	2.80
2	20.38	7.98	5.65
3	29.02	12.37	8.21
4	36.58	16.50	10.28
5	43.86	20.35	13.11
6	51.12	24.67	16.43
7	58.09	28.82	19.32
8	64.74	33.13	22.54
9	70.97	37.07	25.55
10	76.83	41.01	28.51
11	83.01	45.19	31.32
12	88.74	49.10	33.54
13	94.93	53.11	35.98
14	100.86	57.05	39.63
15	106.26	61.16	42.76

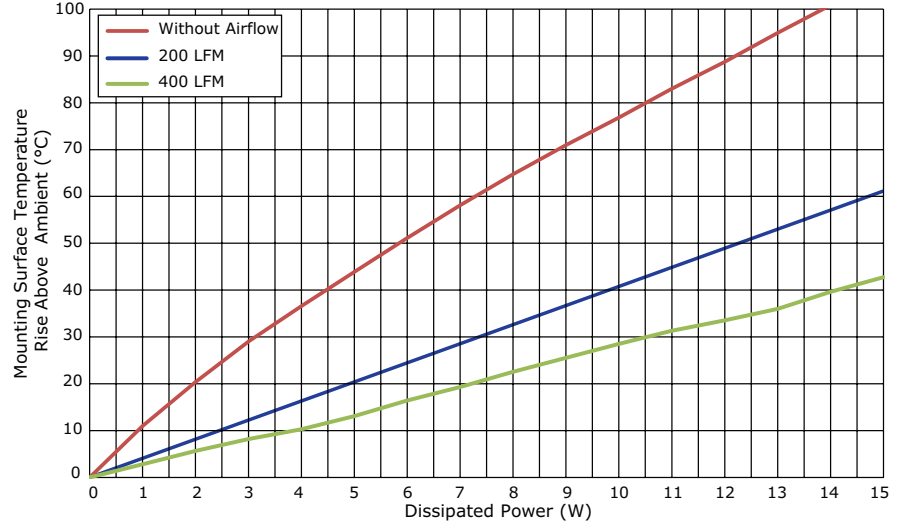

T_{hs}: "hot spot" temperature measured on the heatsink
 T_a: ambient temperature

PERFORMANCE CURVES (CONTINUED)

HSE-B18381-035H

Power (W)	Heatsink Temperature Rise Above Ambient ($\Delta T = T_{hs} - T_a$) (°C)		
	Natural Conv.	200 LFM	400 LFM
0	0	0	0
1	8.34	3.52	2.48
2	17.28	7.15	5.14
3	24.87	10.93	7.81
4	31.91	13.98	10.40
5	37.99	17.64	12.99
6	43.96	21.23	15.68
7	49.59	24.98	18.29
8	55.07	28.39	20.98
9	60.30	32.32	23.53
10	65.45	36.09	26.23
11	70.65	39.56	28.77
12	75.05	43.04	31.44
13	79.53	46.43	34.11
14	83.55	49.75	36.86
15	88.31	53.73	39.41

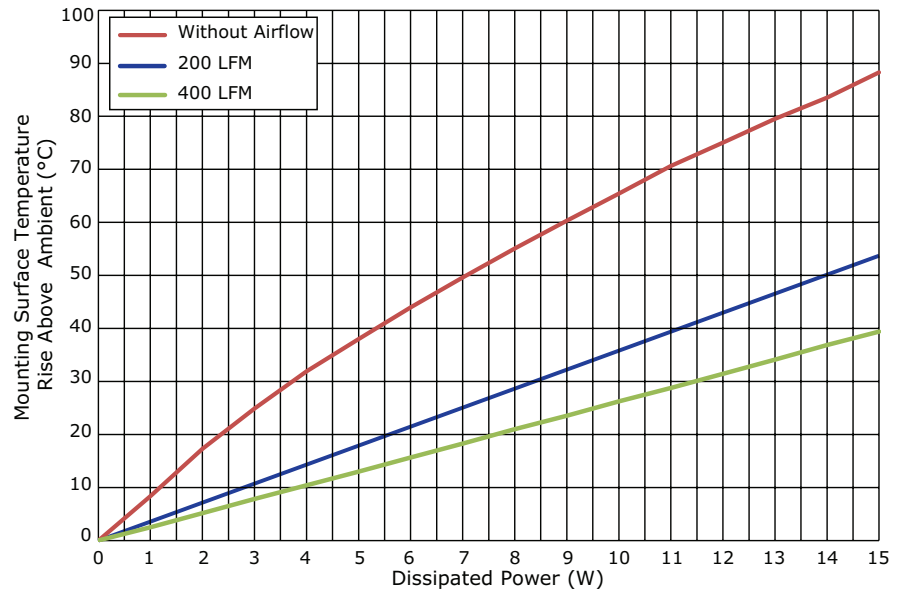

T_{hs} : "hot spot" temperature measured on the heatsink
 T_a : ambient temperature

PERFORMANCE CURVES (CONTINUED)

HSE-B18508-035H

Power (W)	Heatsink Temperature Rise Above Ambient ($\Delta T = T_{hs} - T_a$) (°C)		
	Natural Conv.	200 LFM	400 LFM
0	0	0	0
1	8.63	2.98	2.21
2	16.33	6.10	4.34
3	22.88	9.00	6.65
4	29.17	12.06	8.83
5	35.07	15.23	11.09
6	40.52	18.23	13.25
7	46.34	21.19	15.32
8	51.61	24.37	17.51
9	56.70	27.50	19.57
10	61.77	30.65	21.84
11	66.74	33.54	23.78
12	71.44	36.80	25.90
13	76.25	39.62	28.07
14	80.09	42.73	30.17
15	84.32	45.73	32.21

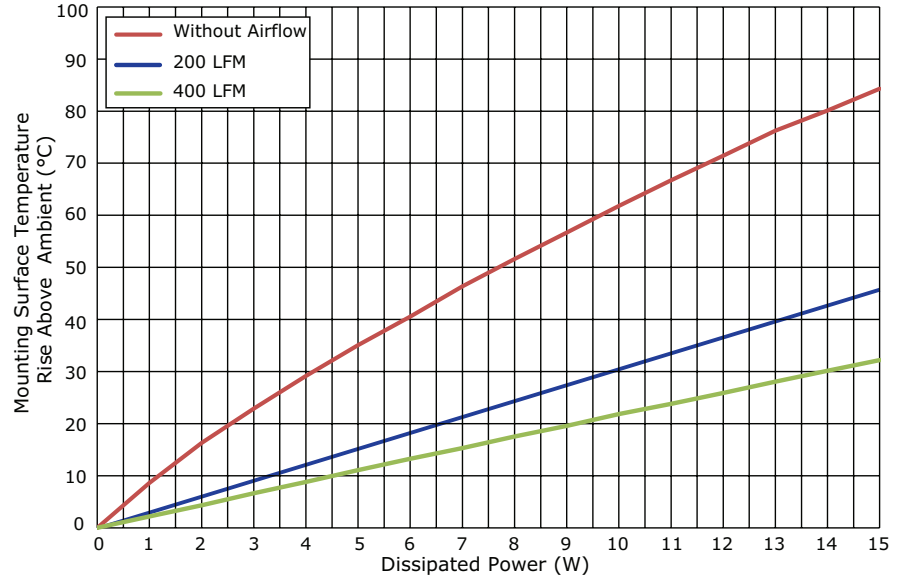

T_{hs}: "hot spot" temperature measured on the heatsink
 T_a: ambient temperature

PERFORMANCE CURVES (CONTINUED)

HSE-B18635-035H

Power (W)	Heatsink Temperature Rise Above Ambient ($\Delta T = T_{hs} - T_a$) (°C)		
	Natural Conv.	200 LFM	400 LFM
0	0	0	0
1	6.61	2.24	1.22
2	12.73	4.57	2.80
3	17.96	7.08	4.43
4	23.17	9.36	5.95
5	27.87	11.84	7.45
6	32.13	14.18	9.12
7	37.08	16.65	10.83
8	41.69	19.14	12.37
9	45.91	21.56	13.84
10	49.93	24.05	15.42
11	53.54	26.41	17.20
12	57.87	28.59	18.81
13	61.43	31.04	20.31
14	65.76	33.48	21.97
15	69.68	35.82	23.48
16	73.44	38.17	25.05
17	77.08	40.51	26.93
18	80.18	42.90	28.82
19	83.71	45.25	30.61
20	87.57	47.63	32.29

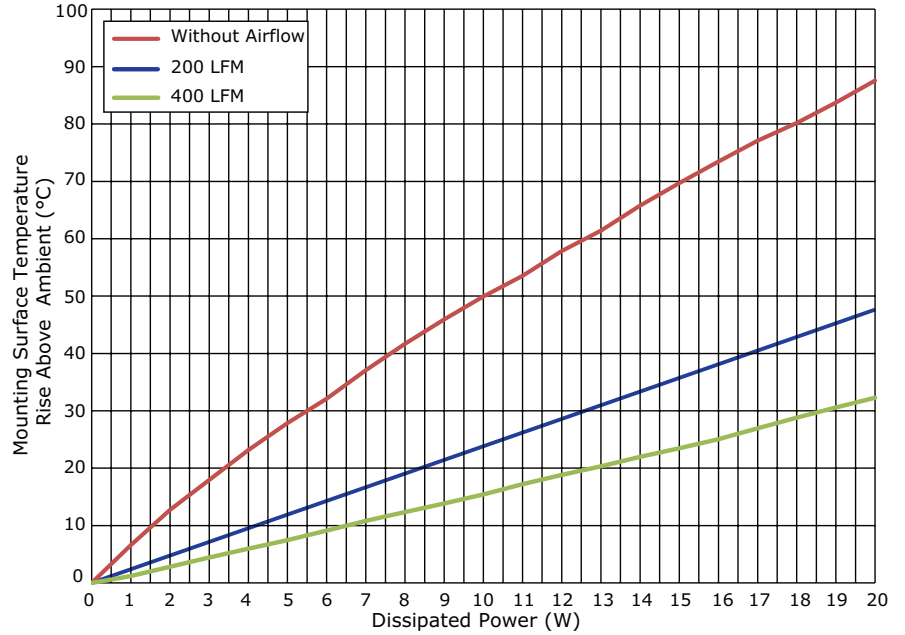

T_{hs}: "hot spot" temperature measured on the heatsink
 T_a: ambient temperature

MECHANICAL DRAWING

units: mm
tolerance: ±0.5 mm

MATERIAL	AL 6063-T5
FINISH	black anodized
PIN MATERIAL	steel
PIN PLATING	tin

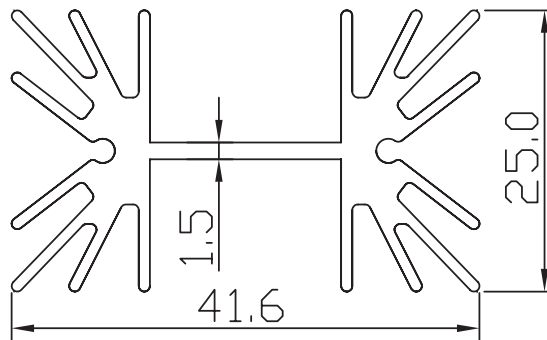
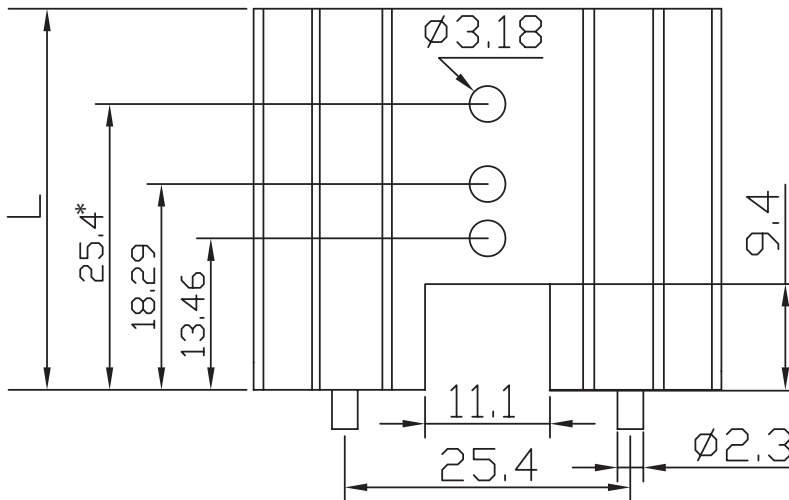

MODEL NO.	LENGTH, L (mm)	WEIGHT (g)
HSE-B18254-035H*	25.4	20
HSE-B18317-035H	31.75	23
HSE-B18381-035H	38.1	28.34
HSE-B18508-035H	50.8	37.8
HSE-B18635-035H	63.5	50

Note: * Mounting hole not present on 25.4 mm length model.

REVISION HISTORY

rev.	description	date
1.0	initial release	05/11/2017
1.01	updated datasheet	09/07/2017

The revision history provided is for informational purposes only and is believed to be accurate.



Headquarters
20050 SW 112th Ave.
Tualatin, OR 97062
800.275.4899

Fax 503.612.2383
cui.com
techsupport@cui.com

CUI offers a one (1) year limited warranty. Complete warranty information is listed on our website.

CUI reserves the right to make changes to the product at any time without notice. Information provided by CUI is believed to be accurate and reliable. However, no responsibility is assumed by CUI for its use, nor for any infringements of patents or other rights of third parties which may result from its use.

CUI products are not authorized or warranted for use as critical components in equipment that requires an extremely high level of reliability. A critical component is any component of a life support device or system whose failure to perform can be reasonably expected to cause the failure of the life support device or system, or to affect its safety or effectiveness.