

## 2A, 1.2MHz Synchronous Step-Down Converter

### General Description

The RT2652 is a high efficiency synchronous, step-down DC-DC converter. The available input voltage range is from 2.7V to 5.5V the regulated output voltage is adjustable from 0.6V to VIN while delivering up to 2A of output current. The internal synchronous low on-resistance power switches increase efficiency and eliminate the need for an external Schottky diode. The switching frequency is fixed internally at 1.2MHz. The 100% duty cycle provides low dropout operation extending battery life in portable systems. Current mode operation with internal compensation allows the transient response to be optimized. The RT2652 is available in the WDFN-10L 3x3 package.

### Ordering Information

RT2652 □□

- Package Type  
QW : WDFN-10L 3x3 (W-Type)
- Lead Plating System  
G : Green (Halogen Free and Pb Free)

Note :

Richtek products are :

- ▶ RoHS compliant and compatible with the current requirements of IPC/JEDEC J-STD-020.
- ▶ Suitable for use in SnPb or Pb-free soldering processes.

### Features

- High Efficiency : Up to 95%
- Fixed Frequency : 1.2MHz
- No Schottky Diode Required
- Internal Compensation
- 0.6V Reference Allows Low Output Voltage
- 100% Duty Cycle for Low Dropout Operation
- OCP, UVP, OTP
- RoHS Compliant and Halogen Free

### Applications

- Enterprise Servers
- Ethernet Switches & Routers
- Global Storage
- Telecom & Industrial
- Cell Phones & DSC's

### Pin Configuration

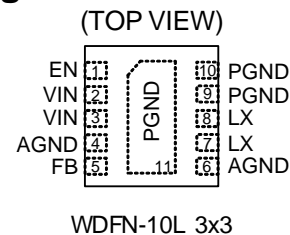

### Marking Information

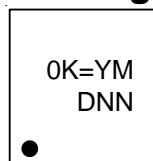

0K= : Product Code  
YMDNN : Date Code

### Simplified Application Circuit

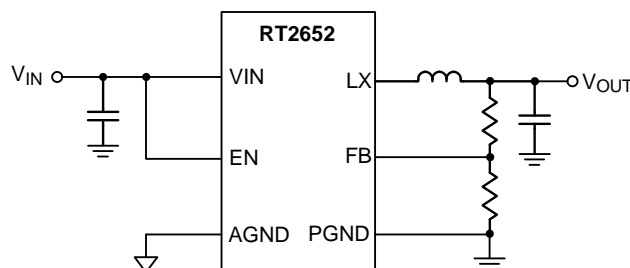

Functional Pin Description

Pin No.	Pin Name	Pin Function
1	EN	Enable Control Input. Pull high to turn on. Do not float.
2, 3	VIN	Power Input. Decouple this pin to GND with a 22μF ceramic capacitor at least.
4, 6	AGND	Analog Ground.
5	FB	Feedback Voltage Input. This pin receives the feedback voltage from an external resistive divider connected across the output.
7, 8	LX	Power MOSFET Switch Node. Connect this pin to the inductor.
9, 10, 11 (Exposed Pad)	PGND	Power Ground. The exposed pad must be soldered to a large PCB and connected to GND for maximum power dissipation.

Functional Block Diagram

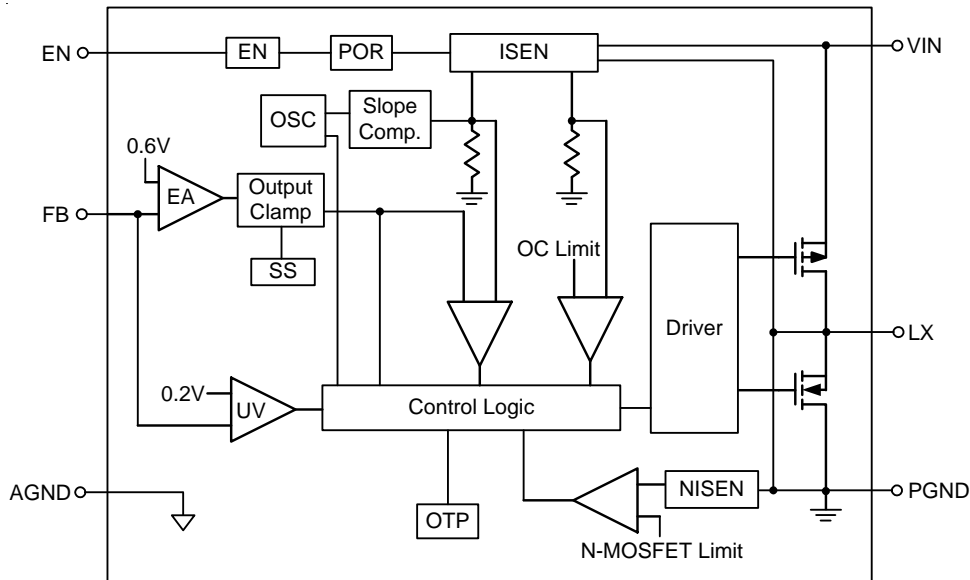

Operation

The RT2652 is a monolithic, constant-frequency, current mode step-down DC-DC converter. During normal operation, the internal high side MOSFET is turned on at the beginning of each cycle. Current in the inductor increases until the peak inductor current reaches the value defined by the internal error amplifier. The error amplifier adjusts the voltage of its output by comparing the feedback signal from a resistor divider on the FB pin with an internal 0.6V reference. When the load current increases, it causes a reduction in the feedback voltage relative to the reference. The error amplifier raises its output voltage until the average inductor current matches the new load current. When the

high side MOSFET turns off, the synchronous power switch (N-MOSFET) turns on until either the bottom current limit is reached or the beginning of the next cycle. The operating frequency is set by the internal oscillator at 1.2MHz. In VIN larger than 6V condition, the high side MOSFET is turned off and the low side MOSFET is switched on until either the VIN over voltage condition is cleared or the low side MOSFET's current limit is reached.

**Absolute Maximum Ratings** (Note 1)

- Supply Voltage,  $V_{IN}$  ----- -0.3V to 6.5V
- Switch Node Voltage,  $V_{LX}$  ----- -0.3V to  $(V_{IN} + 0.3V)$
- Other Pins ----- -0.3V to 6.5V
- Power Dissipation,  $P_D$  @  $T_A = 25^\circ C$   
 WDFN-10L 3x3 ----- 1.429W
- Package Thermal Resistance (Note 2)  
 WDFN-10L 3x3,  $\theta_{JA}$  -----  $70^\circ C/W$   
 WDFN-10L 3x3,  $\theta_{JC}$  -----  $8.2^\circ C/W$
- Junction Temperature -----  $150^\circ C$
- Lead Temperature (Soldering, 10 sec.) -----  $260^\circ C$
- Storage Temperature Range -----  $-65^\circ C$  to  $150^\circ C$
- ESD Susceptibility (Note 3)  
 HBM (Human Body Model) ----- 2kV

**Recommended Operating Conditions** (Note 4)

- Supply Voltage,  $V_{IN}$  ----- 2.7V to 5.5V
- Junction Temperature Range -----  $-40^\circ C$  to  $125^\circ C$
- Ambient Temperature Range -----  $-40^\circ C$  to  $85^\circ C$

**Electrical Characteristics**

( $V_{IN} = 3.3V$ ,  $T_A = 25^\circ C$  unless otherwise specified)

Parameter		Symbol	Test Conditions	Min	Typ	Max	Unit
Feedback Reference Voltage		$V_{REF}$		0.594	0.6	0.606	V
Feedback Leakage Current		$I_{FB}$		--	0.1	0.4	$\mu A$
DC Bias Current			Active, $V_{FB} = 0.7V$ , not switching	--	110	220	$\mu A$
			Shutdown	--	--	1	$\mu A$
Output Voltage Line Regulation			$V_{IN} = 2.7V$ to $5.5V$	--	0.04	--	%/V
Output Voltage Load Regulation			$I_{OUT} = 10mA$ to $2000mA$	--	0.2	--	%/A
Switch Leakage Current			$EN = 0V$	--	--	1	$\mu A$
Switching Frequency				0.96	1.2	1.44	MHz
Switch On-Resistance	High-Side	$R_{DS(ON)_H}$		--	110	130	$m\Omega$
	Low-Side	$R_{DS(ON)_L}$		--	70	90	
P-MOSFET Current Limit		$I_{LIM}$		2.5	3.5	--	A
Under Voltage Lockout Threshold			VDD Rising	--	2.4	--	V
			VDD Falling	--	2.2	--	V
EN Input Voltage	Logic-High	$V_{IH}$		1.5	--	--	V
	Logic-Low	$V_{IL}$		--	--	0.3	
EN Pull Low Resistance				--	500	--	$k\Omega$

Parameter	Symbol	Test Conditions	Min	Typ	Max	Unit
Over Temperature Protection (latch-off)			--	150	--	°C
Soft-Start Time			1.3	--	--	ms
V <sub>OUT</sub> Discharge Resistance			--	100	150	Ω
V <sub>OUT</sub> UVP (latch-off)			--	33	--	%

**Note 1.** Stresses beyond those listed “Absolute Maximum Ratings” may cause permanent damage to the device. These are stress ratings only, and functional operation of the device at these or any other conditions beyond those indicated in the operational sections of the specifications is not implied. Exposure to absolute maximum rating conditions may affect device reliability.

**Note 2.**  $\theta_{JA}$  is measured at  $T_A = 25^\circ\text{C}$  on a high effective thermal conductivity four-layer test board per JEDEC 51-7.  $\theta_{JC}$  is measured at the exposed pad of the package.

**Note 3.** Devices are ESD sensitive. Handling precaution is recommended.

**Note 4.** The device is not guaranteed to function outside its operating conditions..

**Typical Application Circuit**

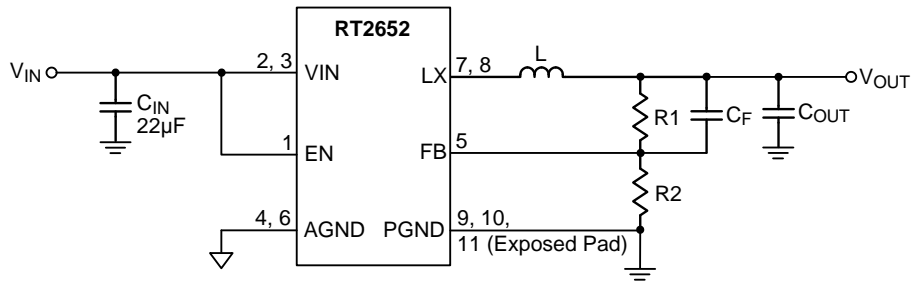
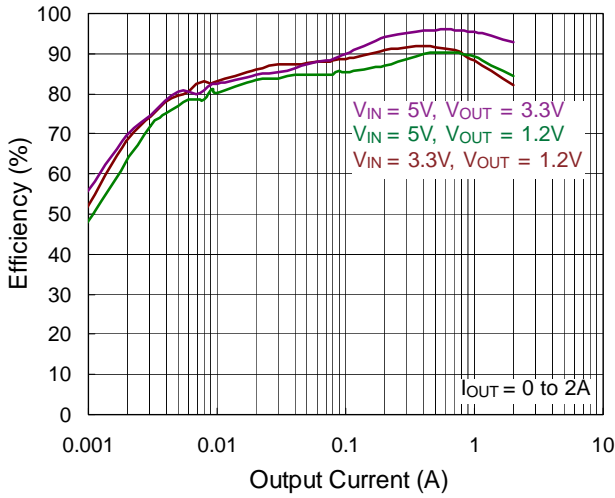

**Table 1. Recommended Component Selection**

<b>V<sub>OUT</sub> (V)</b>	<b>R1 (kΩ)</b>	<b>R2 (kΩ)</b>	<b>C<sub>F</sub> (pF)</b>	<b>L (μH)</b>	<b>C<sub>OUT</sub> (μF)</b>
3.3	37	8.2	200	2	22
2.5	26	8.2	200	2	22
1.8	16.5	8.2	200	1.5	22
1.5	12.3	8.2	200	1.5	22
1.2	8.2	8.2	200	1.5	22
1	5.6	8.2	200	1.5	22

Typical Operating Characteristics

Efficiency vs. Output Current



Efficiency vs. Output Current

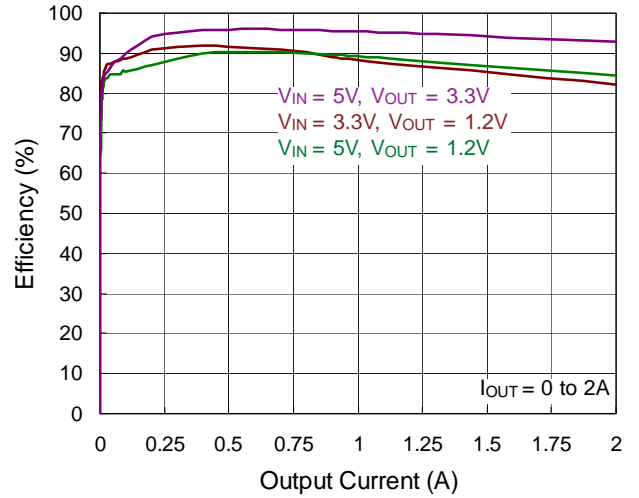

Output Voltage vs. Output Current

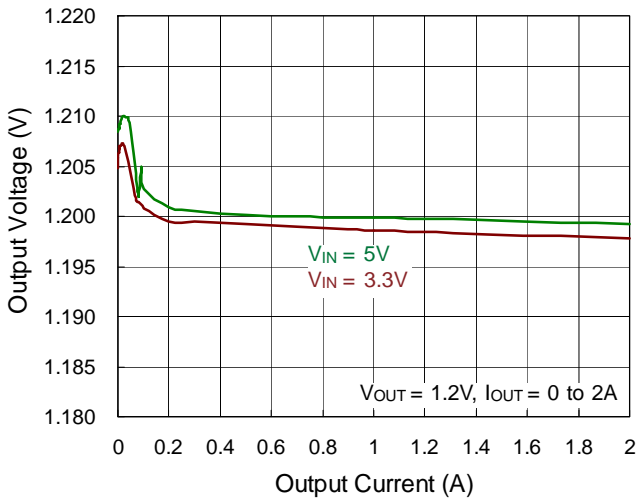

Output Voltage vs. Output Current

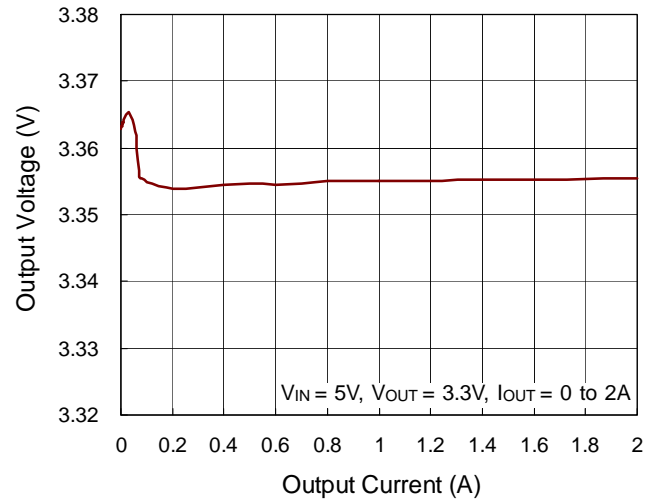

Switching Frequency vs. Temperature

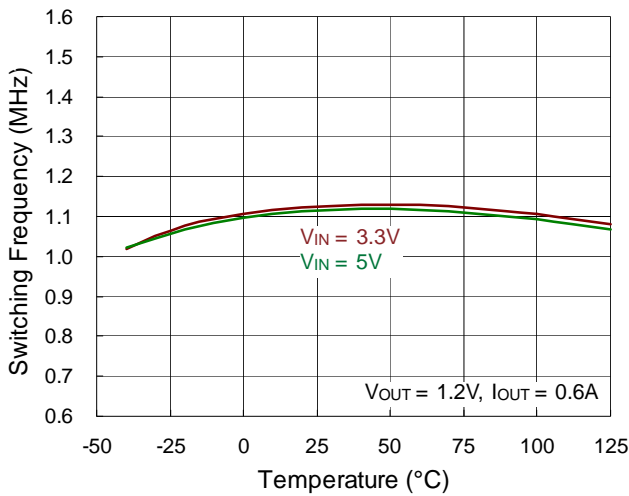

Switching Frequency vs. Temperature

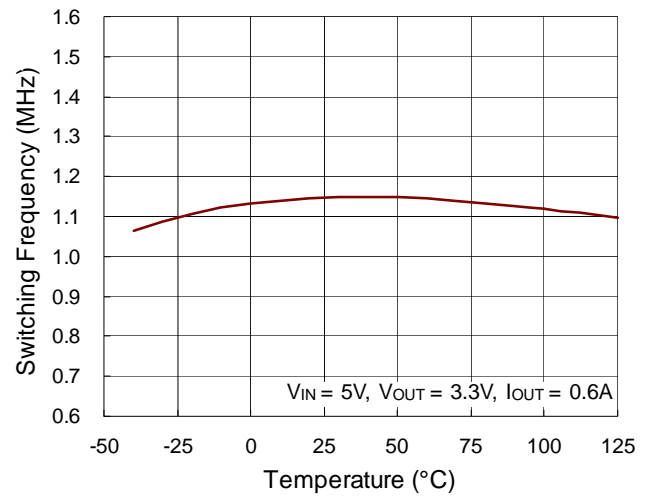

**V<sub>IN</sub> UVLO vs. Temperature**

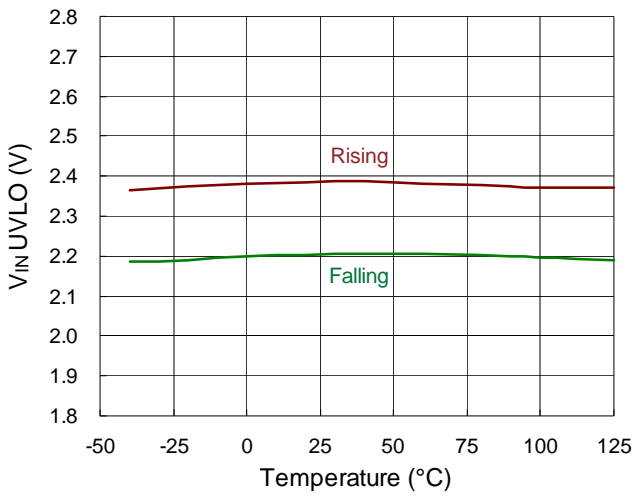

**Enable Voltage vs. Temperature**

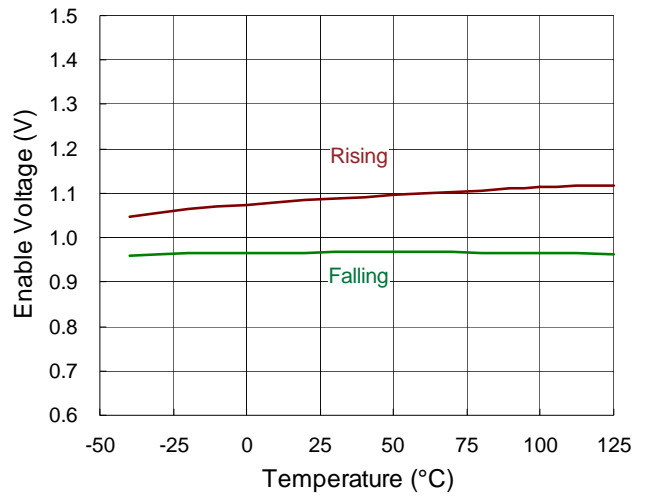

**Load Transient Response**

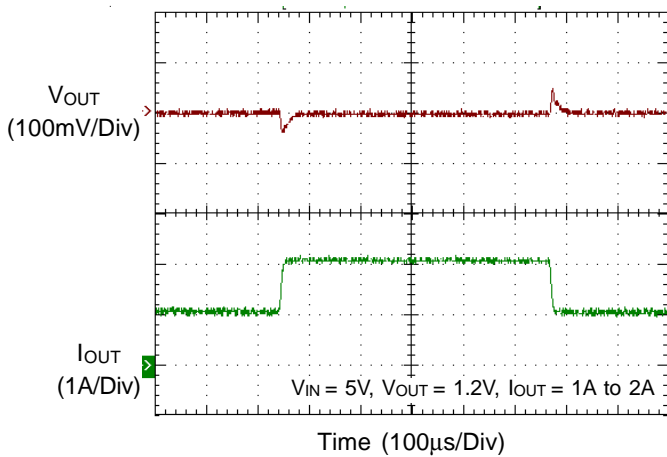

**Load Transient Response**

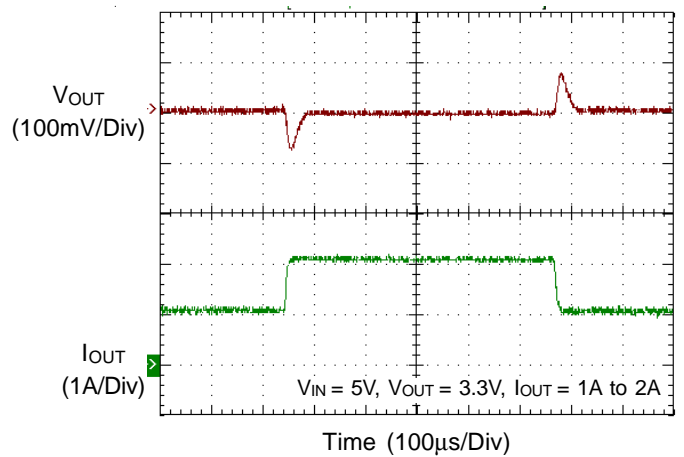

**Output Ripple Voltage**

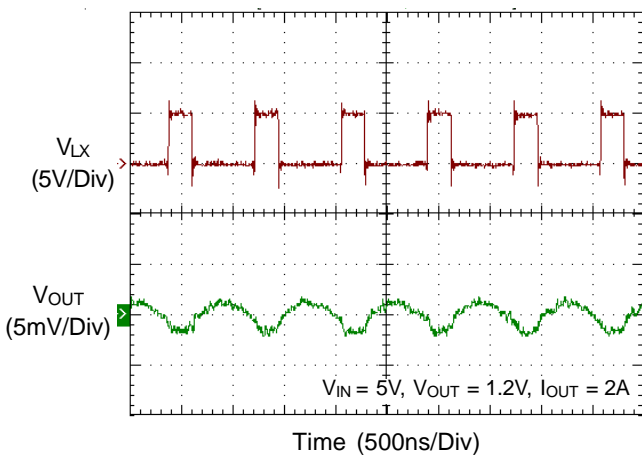

**Output Ripple Voltage**

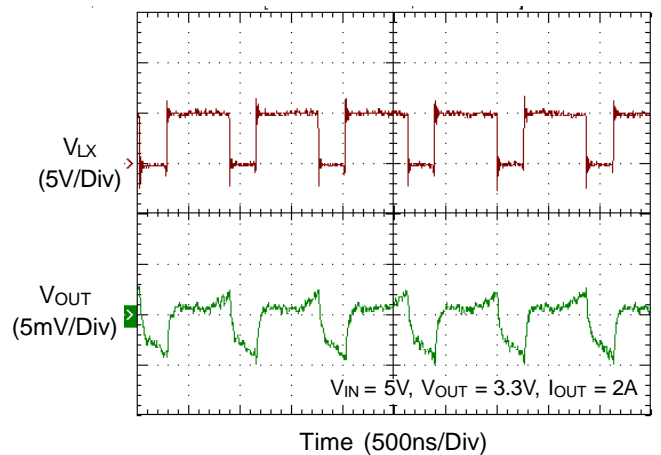

Power On from VIN

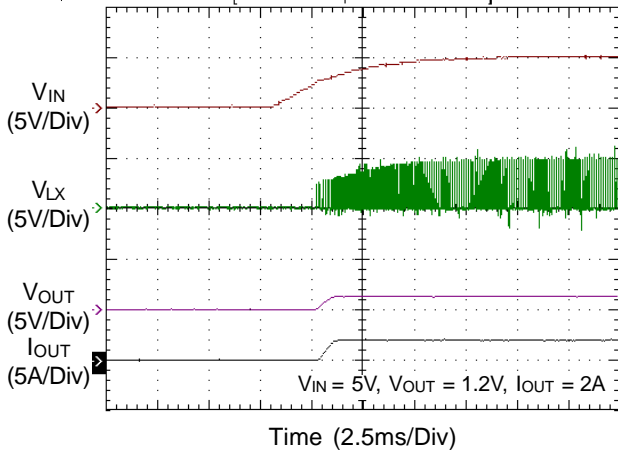

Power On from VIN

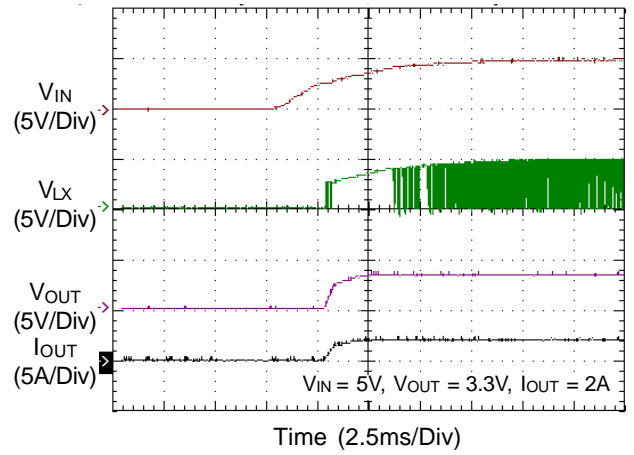

Power Off from VIN

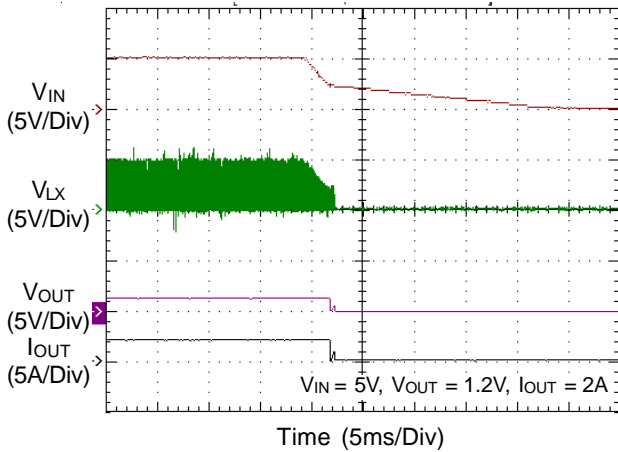

Power Off from VIN

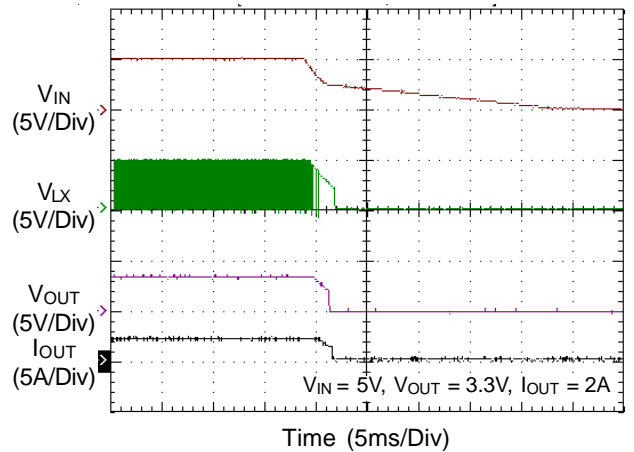

Power On from EN

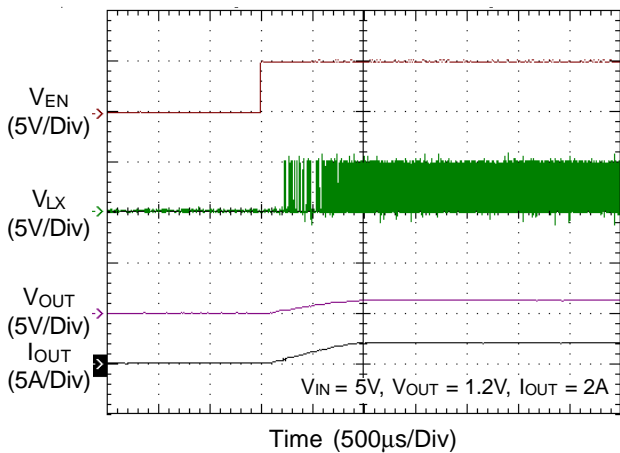

Power On from EN

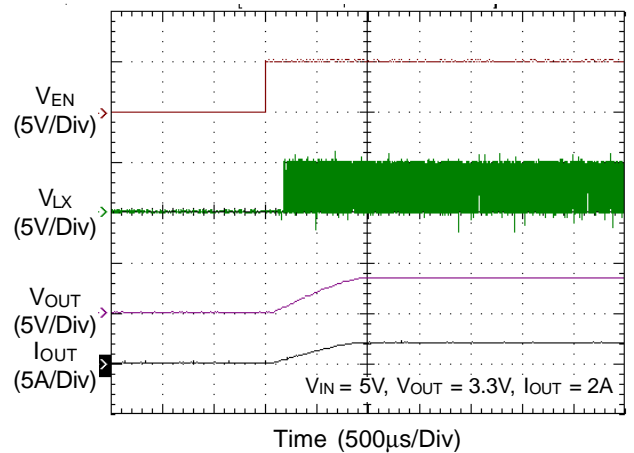



**Power Off from EN**

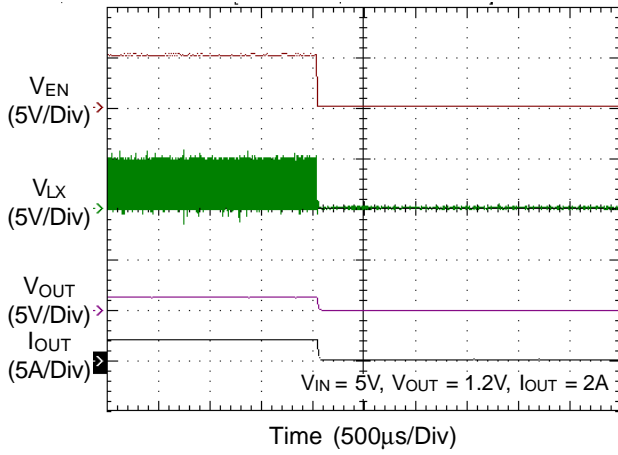

**Power Off from EN**

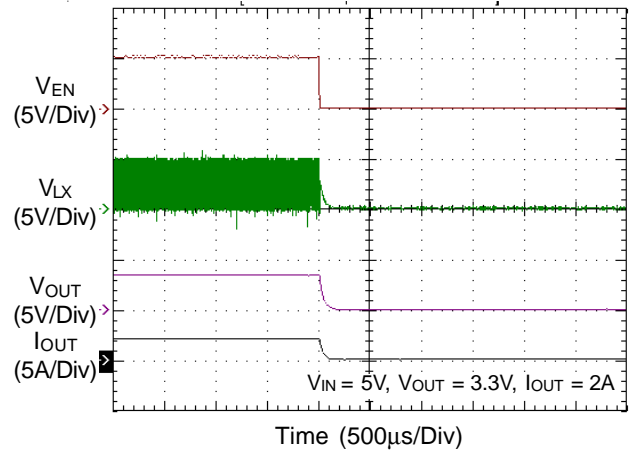

**Reference Voltage vs. Temperature**

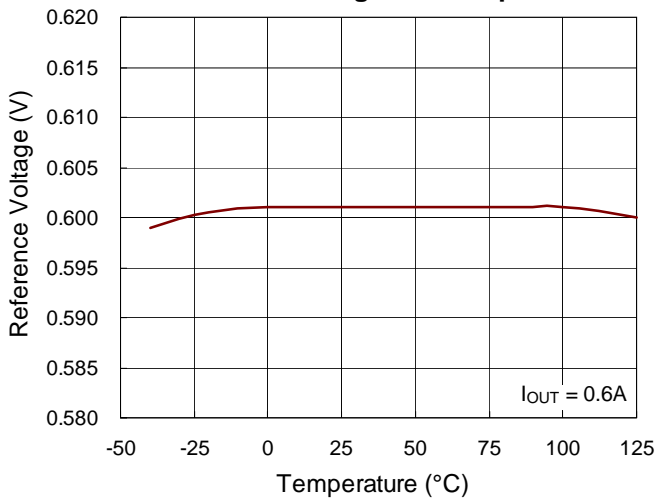

## Application Information

The RT2652 is a single-phase buck PWM converter. It provides single feedback loop, current mode control with fast transient response. An internal 0.6V reference allows the output voltage to be precisely regulated for low output voltage applications. A fixed switching frequency (1.2MHz) oscillator and internal compensation are integrated to minimize external component count.

### Output Voltage Setting

The output voltage is set by an external resistive voltage divider according to the following equation :

$$V_{OUT} = V_{REF} \left( 1 + \frac{R1}{R2} \right)$$

Where  $V_{REF}$  is equals 0.6V (typ.).

The resistive voltage divider allows the FB pin to sense a fraction of the output voltage as shown in Figure 1.

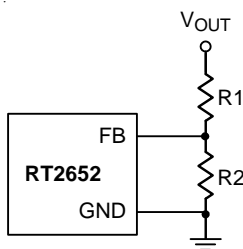

Figure 1. Setting the Output Voltage

### Chip Enable and Disable

The EN pin allows for power sequencing between the controller bias voltage and another voltage rail. The RT2652 remains in shutdown if the EN pin is lower than 400mV. The recommended EN falling slew rate is faster than  $1V/33\mu s$ . When the EN pin rises above the  $V_{EN}$  trip point, the RT2652 begins a new initialization and soft-start cycle.

### Inductor Selection

For a given input and output voltage, the inductor value and operating frequency determine the ripple current. The ripple current  $\Delta I_L$  increases with higher  $V_{IN}$  and decreases with higher inductance.

$$\Delta I_L = \left[ \frac{V_{OUT}}{f \times L} \right] \times \left[ 1 - \frac{V_{OUT}}{V_{IN}} \right]$$

Having a lower ripple current reduces not only the ESR losses in the output capacitors but also the output voltage ripple. Highest efficiency operation is achieved by reducing ripple current at low frequency, but a large inductor is required to attain this goal. For ripple current selection, the value of  $\Delta I_L = 0.4(I_{MAX})$  is a reasonable starting point. The largest ripple current occurs at the highest  $V_{IN}$ . To guarantee that the ripple current stays below a specified maximum value, the inductor should be chosen according to the following equation :

$$L = \left[ \frac{V_{OUT}}{f \times \Delta I_L(MAX)} \right] \times \left[ 1 - \frac{V_{OUT}}{V_{IN(MAX)}} \right]$$

### Slope Compensation and Inductor Peak Current

Slope compensation provides stability in constant frequency architectures by preventing sub-harmonic oscillations at duty cycles greater than 50%. It is accomplished internally by adding a compensating ramp to the inductor current signal. Normally, the maximum inductor peak current is reduced when slope compensation is added. In this IC, however, separated inductor current signal is used to monitor over current condition and this keeps the maximum output current relatively constant regardless of duty cycle.

### Low Dropout Operation

The RT2652 is designed to operate down to an input supply voltage of 2.7V. One important consideration at low input supply voltage is that the  $R_{DS(ON)}$  of the P-Channel and N-Channel power switches increases. The user should calculate the power dissipation when the RT2652 is used at 100% duty cycle with low input voltages to ensure that thermal limits are not exceeded. Slope compensation and inductor peak current slope compensation provides stability in constant frequency architectures by preventing sub-harmonic oscillations at duty cycles greater than 50%. It is accomplished internally by adding a compensating ramp to the inductor current signal. Normally, the maximum inductor peak current is reduced when slope compensation is added. In the RT2652, however, separated inductor current signals are used to monitor over current condition. This keeps the maximum output current relatively constant regardless of duty cycle.

**Short Circuit Protection**

When the output is shorted to ground, the inductor current decays very slowly during a single switching cycle. A current runaway detector is used to monitor inductor current. As current increases beyond the control of current loop, switching cycles will be skipped to prevent current runaway from occurring.

**Under Voltage Lockout Threshold**

The IC includes an input Under Voltage Lockout Protection (UVLO). If the input voltage exceeds the UVLO rising threshold voltage, the converter resets and prepares the PWM for operation. If the input voltage falls below the UVLO falling threshold voltage during normal operation, the device stops switching. The UVLO rising and falling threshold voltage includes a hysteresis to prevent noise caused reset.

**Thermal Shutdown**

The device implements an internal thermal shutdown function when the junction temperature exceeds 150°C. The thermal shutdown disables the device until the junction temperature drops below the hysteresis (20°C typ.). Then, the device is re-enabled and automatically reinstates the power up sequence.

**Thermal Considerations**

For continuous operation, do not exceed absolute maximum junction temperature. The maximum power dissipation depends on the thermal resistance of the IC package, PCB layout, rate of surrounding airflow, and difference between junction and ambient temperature. The maximum power dissipation can be calculated by the following formula :

$$P_{D(MAX)} = (T_{J(MAX)} - T_A) / \theta_{JA}$$

where  $T_{J(MAX)}$  is the maximum junction temperature,  $T_A$  is the ambient temperature, and  $\theta_{JA}$  is the junction to ambient thermal resistance.

For recommended operating condition specifications, the maximum junction temperature is 125°C. The junction to ambient thermal resistance,  $\theta_{JA}$ , is layout dependent. For WDFN-10L 3x3 packages, the thermal resistance,  $\theta_{JA}$ , is 70°C/W on a standard JEDEC 51-7 four-layer thermal test

board. The maximum power dissipation at  $T_A = 25^\circ\text{C}$  can be calculated by the following formulas :

$$P_{D(MAX)} = (125^\circ\text{C} - 25^\circ\text{C}) / (70^\circ\text{C/W}) = 1.429\text{W for WDFN-10L 3x3 package}$$

The maximum power dissipation depends on the operating ambient temperature for fixed  $T_{J(MAX)}$  and thermal resistance,  $\theta_{JA}$ . The derating curves in Figure 2 allow the designer to see the effect of rising ambient temperature on the maximum power dissipation.

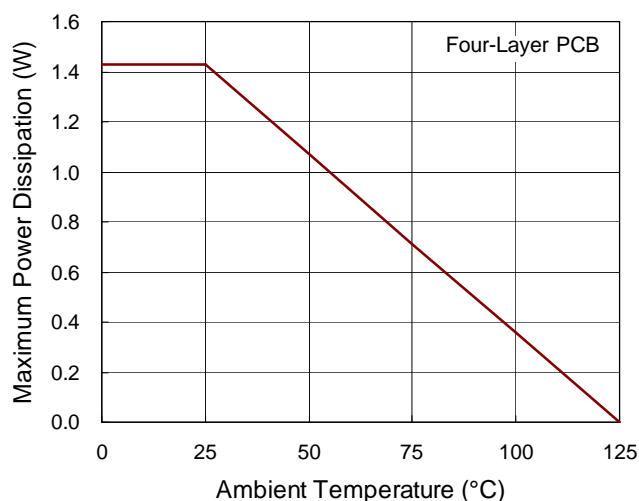
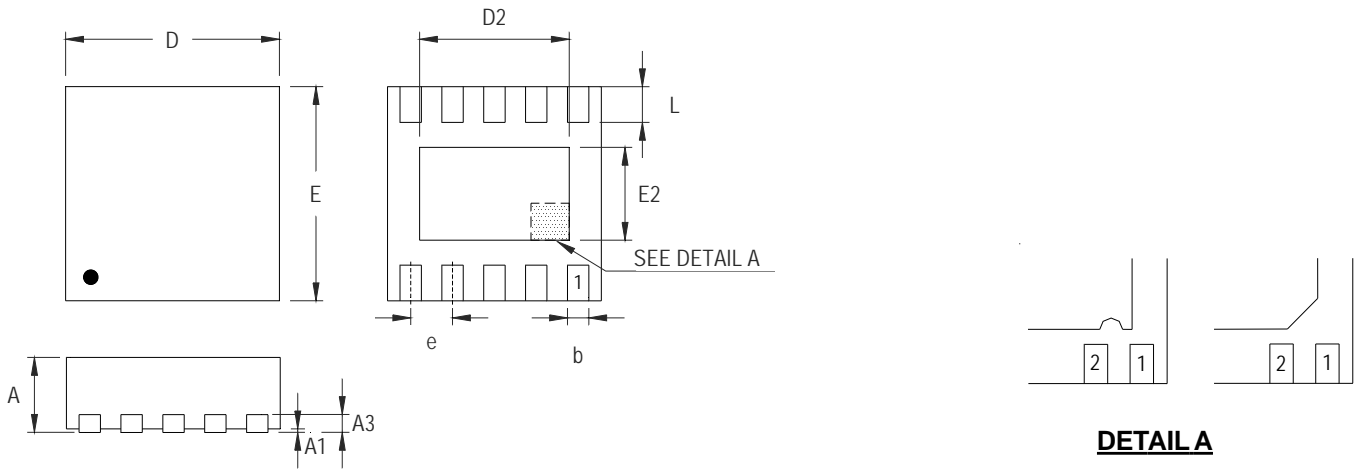

Figure 2. Derating Curve of Maximum Power Dissipation

Outline Dimension



Pin #1 ID and Tie Bar Mark Options

Note : The configuration of the Pin #1 identifier is optional, but must be located within the zone indicated.

Symbol	Dimensions In Millimeters		Dimensions In Inches	
	Min	Max	Min	Max
A	0.700	0.800	0.028	0.031
A1	0.000	0.050	0.000	0.002
A3	0.175	0.250	0.007	0.010
b	0.180	0.300	0.007	0.012
D	2.950	3.050	0.116	0.120
D2	2.300	2.650	0.091	0.104
E	2.950	3.050	0.116	0.120
E2	1.500	1.750	0.059	0.069
e	0.500		0.020	
L	0.350	0.450	0.014	0.018

W-Type 10L DFN 3x3 Package

Richtek Technology Corporation

14F, No. 8, Tai Yuen 1<sup>st</sup> Street, Chupei City  
 Hsinchu, Taiwan, R.O.C.  
 Tel: (8863)5526789

Richtek products are sold by description only. Richtek reserves the right to change the circuitry and/or specifications without notice at any time. Customers should obtain the latest relevant information and data sheets before placing orders and should verify that such information is current and complete. Richtek cannot assume responsibility for use of any circuitry other than circuitry entirely embodied in a Richtek product. Information furnished by Richtek is believed to be accurate and reliable. However, no responsibility is assumed by Richtek or its subsidiaries for its use; nor for any infringements of patents or other rights of third parties which may result from its use. No license is granted by implication or otherwise under any patent or patent rights of Richtek or its subsidiaries.