

3.3V LVDS Low Jitter XO

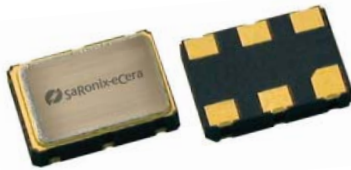

7.0 x 5.0mm Ceramic SMD

Product Features

- 38.88 to 162 MHz Frequency Range
- <1 ps RMS jitter with non-PLL design
- Designed for standard reflow & washing techniques
- IBIS models available
- Pb-free & RoHS/Green compliant

Product Description

The PX Series 3.3V crystal clock oscillator achieves superb jitter and stability over a broad range of operating conditions and frequencies. The output clock signal, generated internally with a non-PLL oscillator design, is compatible with LVDS logic levels. The device, available on tape and reel, is contained in a 7x5mm surface-mount ceramic package.

Applications

The PX Series is ideal for high-speed applications requiring low jitter, including:

- 1/10 Gigabit Ethernet
- 2/4/10G FibreChannel
- Serial Attached SCSI (SAS)
- Server & Storage platforms
- SONET/SDH linecards
- Passive Optical Network (PON) devices
- HD Video Systems

Package:

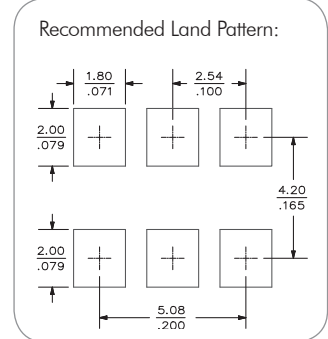
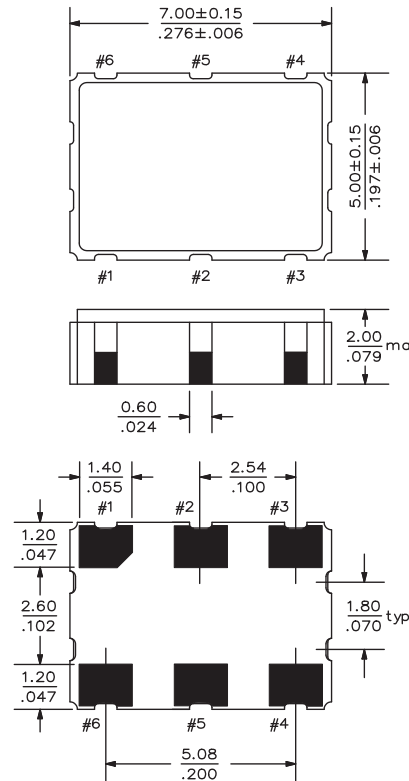

Pin Functions:

Pin	Function
1	OE or NC
2	OE or NC
3	Ground
4	Q Output
5	\bar{Q} Output
6	V _{CC}

Part Ordering Information:

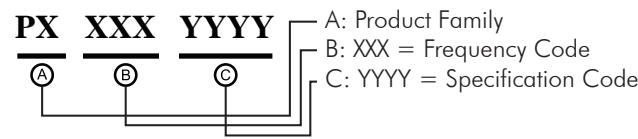

Following the above format, Saronix-eCera part numbers will be assigned upon confirmation of exact customer requirements.

Legacy Ordering Information - For Reference Only:

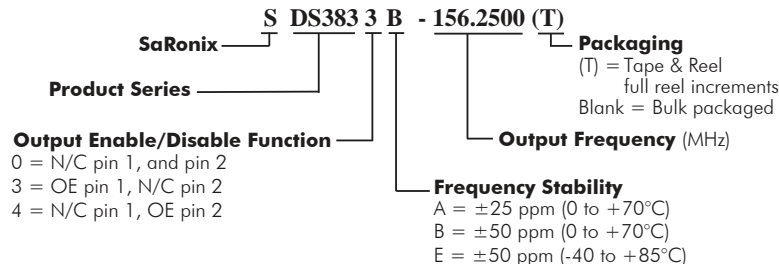

Electrical Performance

Parameter	Min.	Typ.	Max.	Units	Notes
Output Frequency	38.88		162	MHz	As specified
Supply Voltage	2.97	3.3	3.63	V	
Supply Current, Enabled		35	47	mA	
Supply Current, Disabled			0.03	mA	
Frequency Stability			±20 to ±50	ppm	See Note 1 below
Operating Temperature Range	-20		+70	°C	Commercial (standard)
	-40		+85		Industrial (standard)
Output Logic 0, V _{OL}	0.9	1.1		V	
Output Logic 1, V _{OH}		1.43	1.6	V	
Output Amplitude Differential	500		900	mV	
Output Load	100Ω +5pF across the outputs				output requires termination
Duty Cycle	45		55	%	measured 50% of waveform
Rise and Fall Time		500	850	ps	measured 20/80% of waveform
Jitter, Phase		0.5	1	ps RMS (1-σ)	12kHz to 20MHz frequency band
Jitter, Total			25	ps pk-pk	100,000 random periods

Notes:

- Stability includes all combinations of operating temperature, load changes, rated input (supply) voltage changes, initial calibration tolerance (25°C), aging (5 year at 40°C average effective ambient temperature), shock and vibration.
- For specifications other than those listed, please contact sales.

Output Enable / Disable Function

Parameter	Min.	Typ.	Max.	Units	Notes
Input Voltage (pin OE), Output Enable	0.7			V	or open
Input Voltage (pin OE), Output Disable (low power standby)			0.3	V	Output disabled to Hi-Z
Internal Pullup Resistance	50			kΩ	
Output Disable Delay			200	ns	
Output Enable Delay			10	ms	

Absolute Maximum Ratings

Parameter	Min.	Typ.	Max.	Units	Notes
Storage Temperature	-55		+125	°C	

Test Circuit

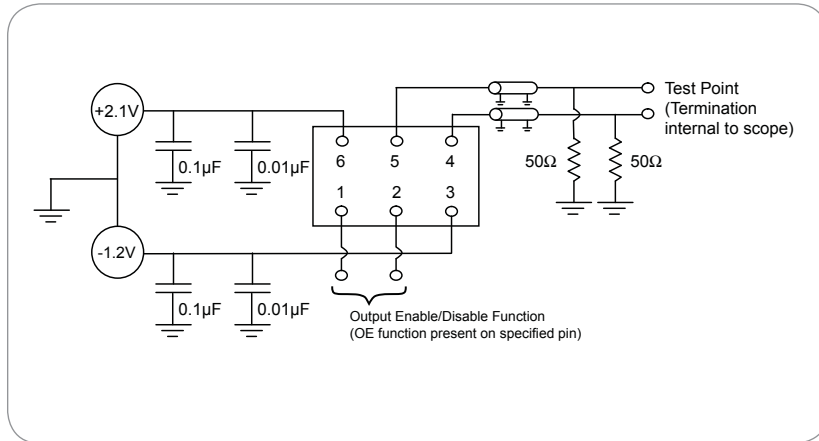

Reflow Soldering Profile

As per IPC/JEDEC J-STD-020C

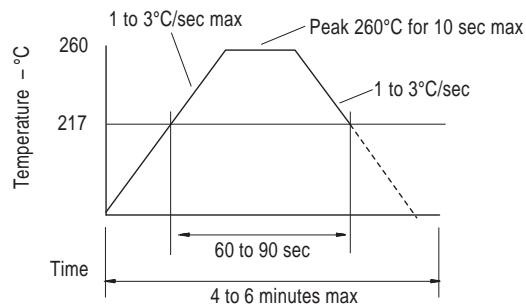

Reliability Test Ratings

This product is rated to meet the following test conditions:

Type	Parameter	Test Condition
Mechanical	Shock	MIL-STD-883, Method 2002, Condition B
Mechanical	Solderability	JESD22-B102-D Method 2 (Preconditioning E)
Mechanical	Terminal strength	MIL-STD-883, Method 2004, Condition D
Mechanical	Gross leak	MIL-STD-883, Method 1014, Condition C
Mechanical	Fine leak	MIL-STD-883, Method 1014, Condition A2 ($R_1 = 2 \times 10^{-8}$ atm cc/s)
Mechanical	Solvent resistance	MIL-STD-202, Method 215
Environmental	Thermal shock	MIL-STD-883, Method 1011, Condition A
Environmental	Moisture resistance	MIL-STD-883, Method 1004
Environmental	Vibration	MIL-STD-883, Method 2007, Condition A
Environmental	Resistance to soldering heat	J-STD-020C Table 5-2 Pb-free devices (2 cycles max)

Output Waveform

