

InGaP HBT GAIN BLOCK MMIC AMPLIFIER, DC - 4 GHz

Typical Applications

The HMC589AST89E is ideal for:

- Cellular / PCS / 3G
- Fixed Wireless & WLAN
- CATV, Cable Modem & DBS
- Microwave Radio & Test Equipment
- IF & RF Applications

Features

- P1dB Output Power: +21 dBm
- Gain: 21 dB
- Output IP3: +33 dBm
- Single Supply: +5V
- Industry Standard SOT89E Package

Functional Diagram

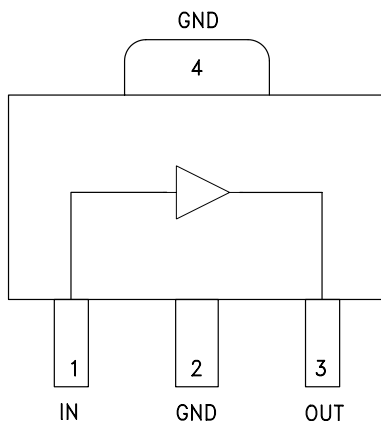

General Description

The HMC589AST89E is an InGaP HBT Gain Block MMIC SMT amplifier covering DC to 4 GHz and packaged in an industry standard SOT89E. The amplifier can be used as a cascadable 50 Ohm RF or IF gain stage as well as a LO or PA driver with up to +19 dBm P1dB output power for cellular/3G, FWA, CATV, microwave radio and test equipment applications. The HMC589AST89E offers 20 dB gain and +33 dBm output IP3 at 1 GHz while requiring only 82 mA from a single positive supply. The HMC589AST89E InGaP HBT gain block offers excellent output power and gain stability over temperature.

Electrical Specifications, $V_s = 5V$, $R_{bias} = 1.8 \text{ Ohm}$, $T_A = +25^\circ \text{ C}$

Parameter		Min.	Typ.	Max.	Units
Gain	DC - 1.0 GHz	19	21		dB
	1.0 - 2.0 GHz	16	19		dB
	2.0 - 3.0 GHz	14	17		dB
	3.0 - 4.0 GHz	13	16		dB
Gain Variation Over Temperature	DC - 5 GHz		0.008		dB/ °C
Input Return Loss	DC - 1.0 GHz		17		dB
	1.0 - 4.0 GHz		10		dB
Output Return Loss	DC - 1.0 GHz		12		dB
	1.0 - 4.0 GHz		8		dB
Reverse Isolation	DC - 4 GHz		23		dB
Output Power for 1 dB Compression (P1dB)	0.5 - 1.0 GHz	17.5	19		dBm
	1.0 - 2.0 GHz	16	19		dBm
	2.0 - 3.0 GHz	16	19		dBm
	3.0 - 4.0 GHz	14.5	18		dBm
Output Third Order Intercept (IP3) (Pout= 0 dBm per tone, 1 MHz spacing)	0.5 - 1.0 GHz		33		dBm
	1.0 - 2.0 GHz		32		dBm
	2.0 - 3.0 GHz		31.5		dBm
	3.0 - 4.0 GHz		29		dBm
Noise Figure	DC - 2.0 GHz		4.0		dB
	2.0 - 4.0 GHz		4.5		dB
Supply Current (Icq)			82	102	mA

Note: Data taken with broadband bias tee on device output.

HMC589A* PRODUCT PAGE QUICK LINKS

Last Content Update: 03/11/2017

COMPARABLE PARTS

View a parametric search of comparable parts.

EVALUATION KITS

- HMC589A Evaluation Board

DOCUMENTATION

Application Notes

- AN-1363: Meeting Biasing Requirements of Externally Biased RF/Microwave Amplifiers with Active Bias Controllers

Data Sheet

- HMC589AST89E: InGaP HBT Gain Block MMIC Amplifier, DC - 4 GHz Data Sheet

TOOLS AND SIMULATIONS

- HMC589A S-parameters

DESIGN RESOURCES

- HMC589A Material Declaration
- PCN-PDN Information
- Quality And Reliability
- Symbols and Footprints

DISCUSSIONS

View all HMC589A EngineerZone Discussions.

SAMPLE AND BUY

Visit the product page to see pricing options.

TECHNICAL SUPPORT

Submit a technical question or find your regional support number.

DOCUMENT FEEDBACK

Submit feedback for this data sheet.

**InGaP HBT GAIN BLOCK
MMIC AMPLIFIER, DC - 4 GHz**

Broadband Gain & Return Loss

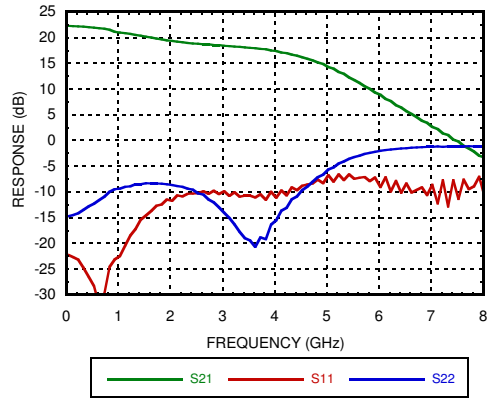

Gain vs. Temperature

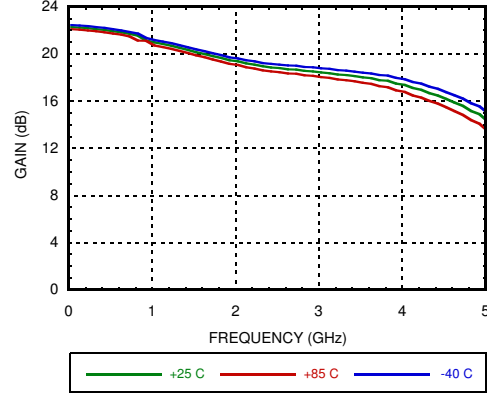

Input Return Loss vs. Temperature

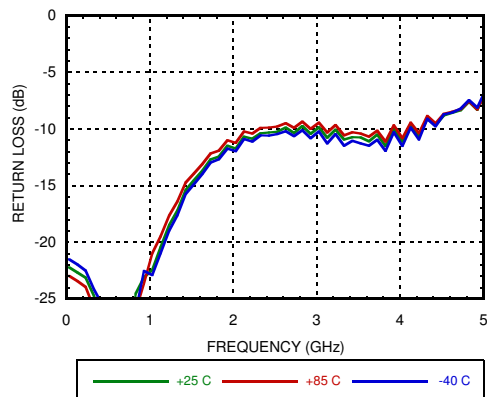

Output Return Loss vs. Temperature

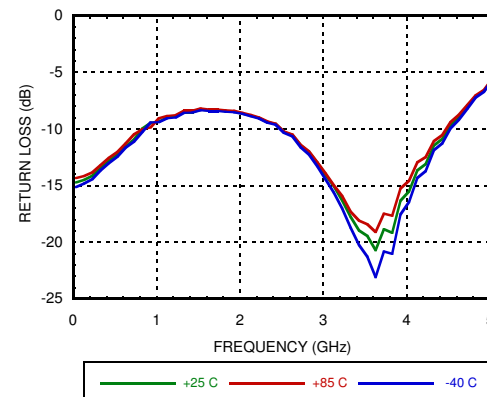

Reverse Isolation vs. Temperature

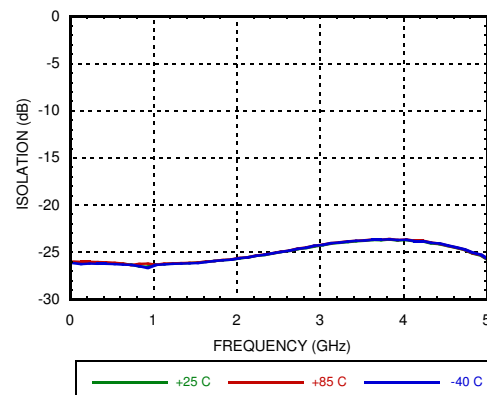

Noise Figure vs. Temperature

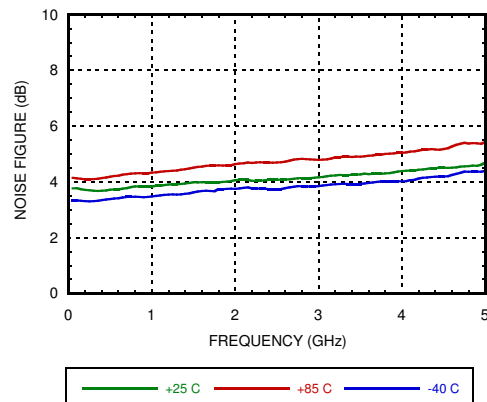

**InGaP HBT GAIN BLOCK
MMIC AMPLIFIER, DC - 4 GHz**

P1dB vs. Temperature

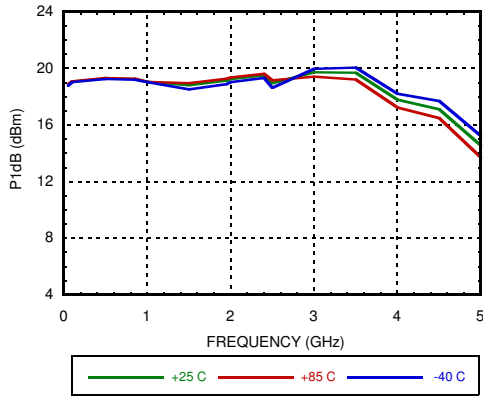

Psat vs. Temperature

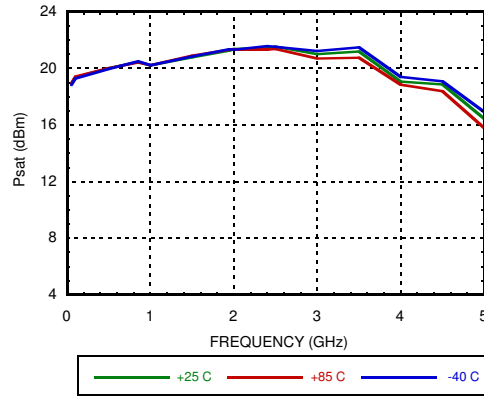

Output IP3 vs. Temperature

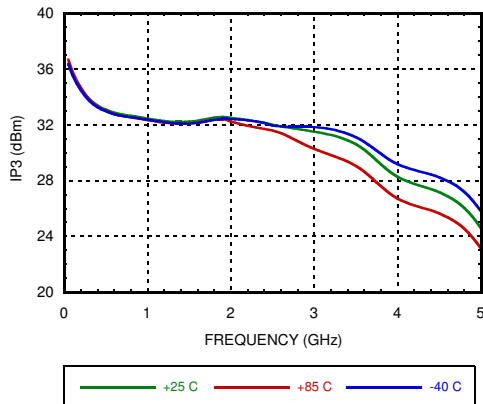

**Gain, Power & OIP3 vs. Supply Voltage
@ 850 MHz, Rbias = 1.8 Ohms**

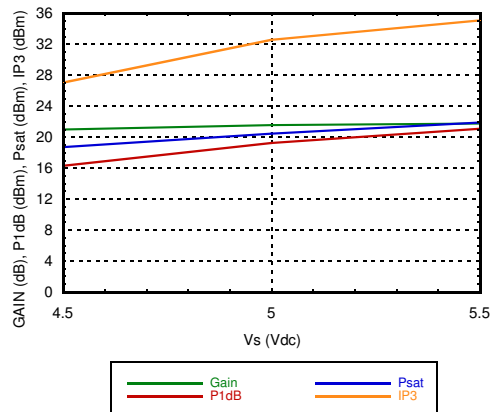

**Vcc vs. Icc Over Temperature for
Fixed Vs= 5V, RBIAS= 1.8 Ohms**

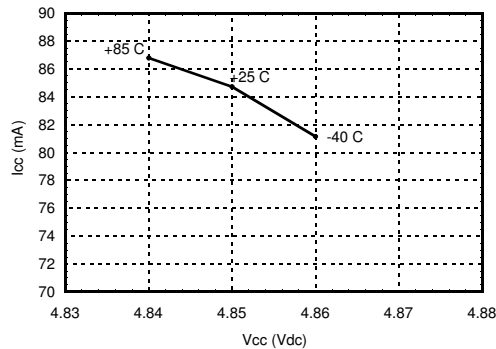

InGaP HBT GAIN BLOCK MMIC AMPLIFIER, DC - 4 GHz

Absolute Maximum Ratings

Collector Bias Voltage (Vcc)	+5.5 Vdc
RF Input Power (RFIN)(Vcc = +5 Vdc)	+10 dBm up to 1 GHz +8 dBm from 1-4 GHz
Junction Temperature	150 °C
Continuous Pdiss (T = 85 °C) (derate 8.4 mW/°C above 85 °C)	0.45 W
Thermal Resistance (junction to ground paddle)	145 °C/W
Storage Temperature	-65 to +150 °C
Operating Temperature	-40 to +85 °C
ESD Sensitivity (HBM)	Class 2



ELECTROSTATIC SENSITIVE DEVICE
OBSERVE HANDLING PRECAUTIONS

Outline Drawing

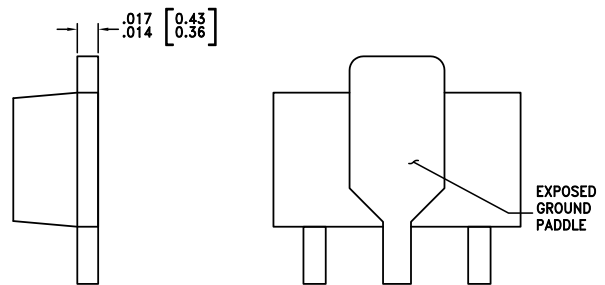
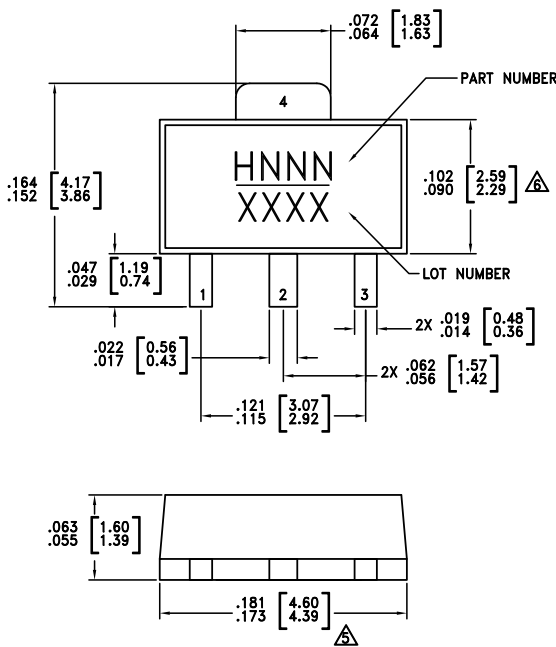

NOTES:

- PACKAGE BODY MATERIAL:
MOLDING COMPOUND MP-180S OR EQUIVALENT.
- LEAD MATERIAL: Cu w/ Ag SPOT PLATING.
- LEAD PLATING: 100% MATTE TIN.
- DIMENSIONS ARE IN INCHES [MILLIMETERS]
- Δ DIMENSION DOES NOT INCLUDE MOLDFLASH OF 0.15mm PER SIDE.
- Δ DIMENSION DOES NOT INCLUDE MOLDFLASH OF 0.25mm PER SIDE.
- ALL GROUND LEADS MUST BE SOLDERED TO PCB RF GROUND.

Package Information

Part Number	Package Body Material	Lead Finish	MSL Rating	Package Marking [2]
HMC589AST89E	RoHS-compliant Low Stress Injection Molded Plastic	100% matte Sn	MSL1 [1]	H589A XXXX

[1] Max peak reflow temperature of 260 °C

[2] 4-Digit lot number XXXX

InGaP HBT GAIN BLOCK MMIC AMPLIFIER, DC - 4 GHz

Pin Descriptions

Pin Number	Function	Description	Interface Schematic
1	IN	This pin is DC coupled. An off chip DC blocking capacitor is required.	
3	OUT	RF output and DC Bias (Vcc) for the output stage.	
2, 4	GND	These pins and package bottom must be connected to RF/DC ground.	

Application Circuit

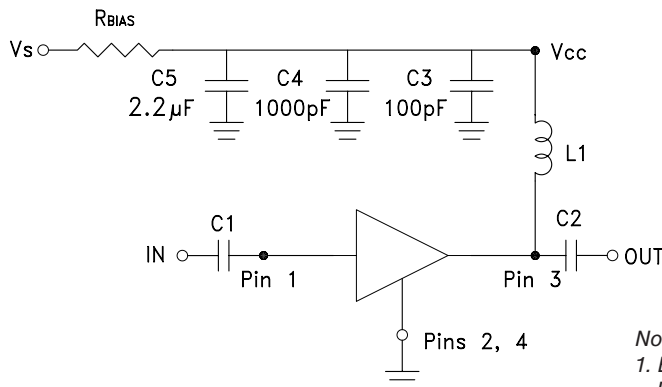

Note:

- External blocking capacitors are required on RFIN and RFOUT.
- RBIAS provides DC bias stability over temperature.

Recommended Bias Resistor Values for $I_{cc} = 88 \text{ mA}$, $R_{bias} = (V_s - V_{cc}) / I_{cc}$

Supply Voltage (Vs)	5V	6V	8V
RBIAS VALUE	1.8 Ω	13 Ω	38 Ω
RBIAS POWER RATING	1/8 W	1/4 W	1/2 W

Recommended Component Values for Key Application Frequencies

Component	Frequency (MHz)						
	50	900	1900	2200	2400	3500	4000
L1	270 nH	56 nH	24 nH	24 nH	15 nH	8.2 nH	8.2 nH
C1, C2	0.01 μF	100 pF	100 pF	100 pF	100 pF	100 pF	100 pF

InGaP HBT GAIN BLOCK MMIC AMPLIFIER, DC - 4 GHz

Evaluation PCB [3]

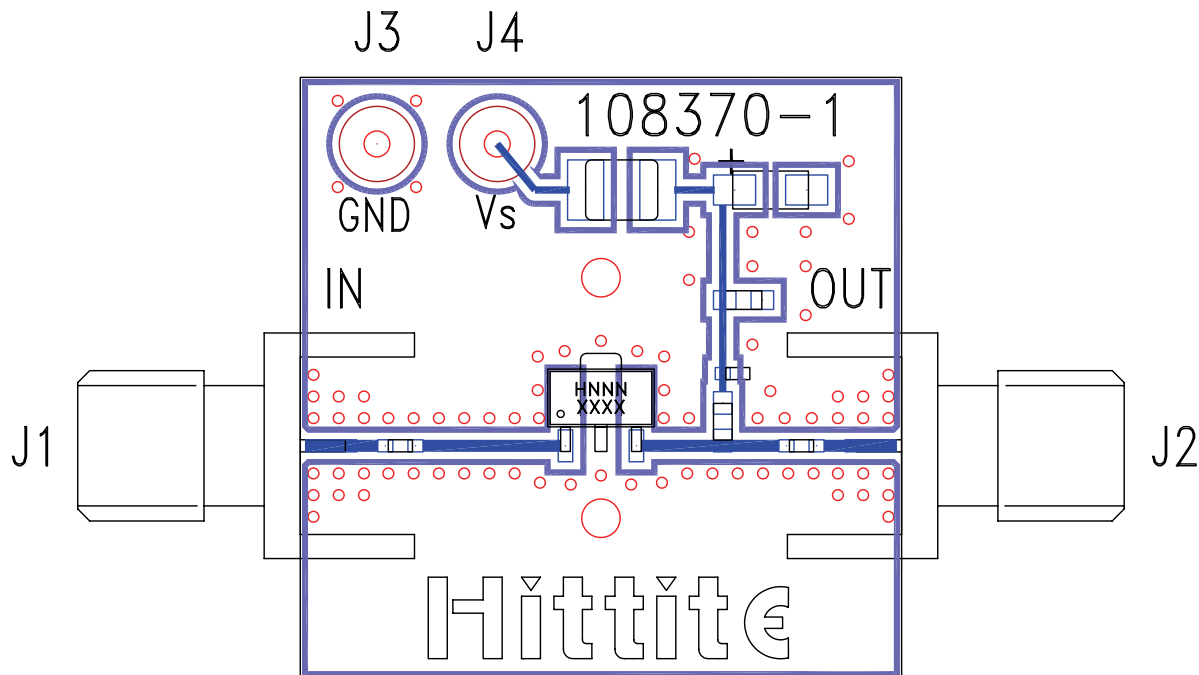

List of Materials for Evaluation PCB EV1HMC589AST89 [1]

Item	Description
J1 - J2	PCB Mount SMA Connector
J3 - J4	DC Pin
C1, C2	Capacitor, 0402 Pkg.
C3	100 pF Capacitor, 0402 Pkg.
C4	1000 pF Capacitor, 0603 Pkg.
C5	2.2 μ F Capacitor, Tantalum
R1	Resistor, 1206 Pkg.
L1	Inductor, 0603 Pkg.
U1	HMC589AST89 / HMC589AST89E
PCB [2]	108370 Evaluation PCB

[1] Reference this number when ordering complete evaluation PCB

[2] Circuit Board Material: Rogers 4350

[3] Evaluation board tuned for 1.9 GHz, 1/8W operation

The circuit board used in the application should use RF circuit design techniques. Signal lines should have 50 Ohm impedance while the package ground leads and package bottom should be connected directly to the ground plane similar to that shown. A sufficient number of via holes should be used to connect the top and bottom ground planes. The evaluation board should be mounted to an appropriate heat sink. The evaluation circuit board shown is available from Hittite upon request.