

- Miniature 9.0 H x 11.5 W x 20.5 L mm (0.35 H x 0.45 W x 0.81 L in)
- Shield plate and resin-molded relay base provide excellent high-frequency characteristics: isolation of 68 dB (typ.), insertion loss of 0.20 dB (typ.), and VSWR of 1.30 (typ.) at 900 MHz
- Ultrasmall and lightweight with pickup coil power of 170 mW (112 mW for high-sensitivity type)
- Plastic sealed construction highly resistant to adverse environmental conditions
- High shock resistance

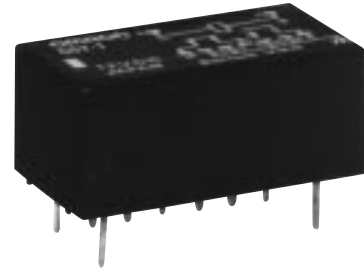

Ordering Information

To Order: Select the part number and add the desired coil voltage rating (e.g., G5Y-1-DC12).

Type	Contact form	Construction	Part number
Standard	SPDT	Fully-sealed	G5Y-1
High-sensitivity			G5Y-1-H

Specifications

■ CONTACT DATA

Load	Resistive load (p.f. = 1)
Rated load	24 VAC 0.01 A 24 VDC 0.01 A 1 W at 900 MHz*
Contact material	Au clad Cu alloy
Carry current	0.10 A
Max. operating voltage	30 VAC, 30 VDC
Max. operating current	0.10 A
Max. switching capacity	1 VA, 1W
Min. permissible load	10 mA at 10 mVDC

* Denotes the value at VSWR ≤1.2.

■ COIL DATA

Standard type

Rated voltage (VDC)	Rated current (mA)	Coil resistance (Ω)	Must operate voltage	Must dropout voltage	Maximum voltage	Power consumption (mW)
			% of rated voltage			
5	60.20	83	75% max.	10% min.	150 at 23°C (73°F) 130 at 50°C (122°F)	Approx. 300
6	50.00	120				
9	33.30	270				
12	25.00	480				
24	12.50	1,920				

High-sensitivity type

Rated voltage (VDC)	Rated current (mA)	Coil resistance (Ω)	Must operate voltage	Must dropout voltage	Maximum voltage	Power consumption (mW)
			% of rated voltage			
5	40.00	125	75% max.	10% min.	150 at 23°C (73°F) 130 at 50°C (122°F)	Approx. 200
6	33.30	180				
9	22.20	405				
12	16.70	720				
24	8.30	2,880				

Note: 1. The rated current and coil resistance are measured at a coil temperature of 23°C (73°F) with a tolerances of $\pm 10\%$.
2. The operating characteristics are measured at a coil temperature of 23°C (73°F).

■ CHARACTERISTICS

Contact resistance		100 m Ω max.
Operate time		10 ms max.
Release time		5 ms max.
Bounce time		5 ms max.
Operating frequency	Mechanical	1,800 operations/hour
	Electrical	1,800 operations/hour (under rated load)
Insulation resistance		100 M Ω min. (at 500 VDC)
Dielectric strength		500 VAC, 50/60 Hz for 1 minute between contacts 1,000 VAC, 50/60 Hz for 1 minute between coil and contact 500 VAC, 50/60 Hz for 1 minute between contact and ground
Vibration	Mechanical durability	10 to 55 Hz, 1.50 mm (0.06 in) double amplitude
	Malfunction durability	
Shock	Mechanical durability	1,000 m/s ² (approx. 100 G)
	Malfunction durability	200 m/s ² (approx. 20 G)
Ambient temperature		-25°C to +60°C (-13° to 140°F)
Humidity		35% to 85% RH
Service life	Mechanical	1 million operations min. (at 1,800 operations/hour)
	Electrical	300,000 operations min. (under rated load at 1,800 operations/hour)
Weight		Approx. 6g (0.21 oz)

Note: Data shown are of initial value.

■ HIGH-FREQUENCY CHARACTERISTICS

Item	Frequency	
	250 MHz	900 MHz
Isolation	70 dB min.	60 dB min.
Insertion loss	0.5 dB max.	
VSWR	1.5 max.	1.8 max.
Carry power	10 W max.	

Note: Line impedance (Z_0) of the measuring instrument is 50 Ω .

■ CHARACTERISTIC DATA

High-frequency characteristics

Measuring conditions of Type G5Y-1.

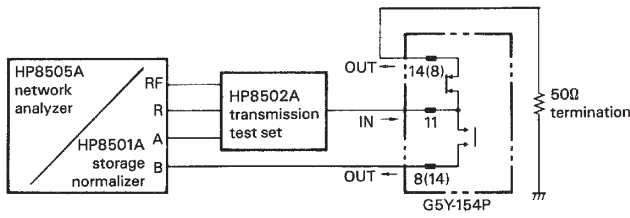

The following characteristics, when a signal is applied from input terminal 11 to output terminal 8 or from input terminal 11 to output terminal 14 of the sample, are measured with contacts unrelated to the measurement terminated at 50Ω.

$$VSWR = \frac{1 + 10^{-\frac{x}{20}}}{1 - 10^{-\frac{x}{20}}}$$

where;
x: return loss

1. Isolation characteristics
2. Insertion loss characteristics
3. Return loss

Note: Conversion formula between return loss and VSWR.

Isolation characteristics
G5Y-1
Frequency vs. isolation

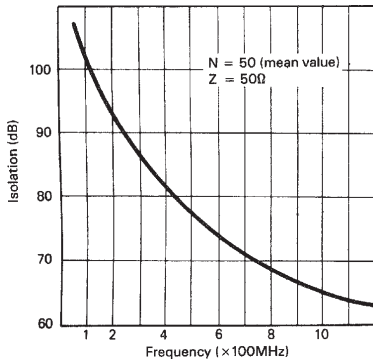

G5Y-1
Distribution of isolation at 250 MHz

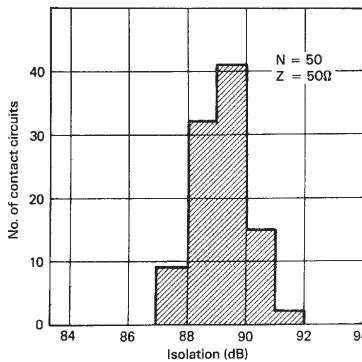

G5Y-1
Distribution of isolation at 900 MHz

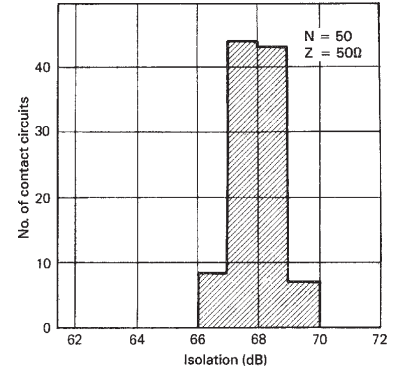

Insertion loss characteristics
G5Y-1
Frequency vs. insertion loss

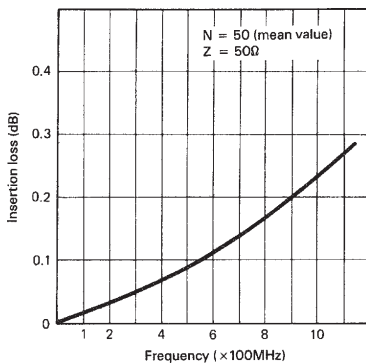

G5Y-1
Distribution of insertion loss at 250 MHz

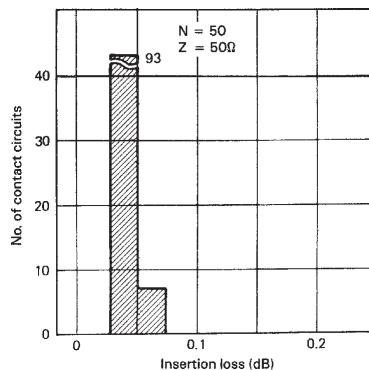

G5Y-1
Distribution of insertion loss at 900 MHz

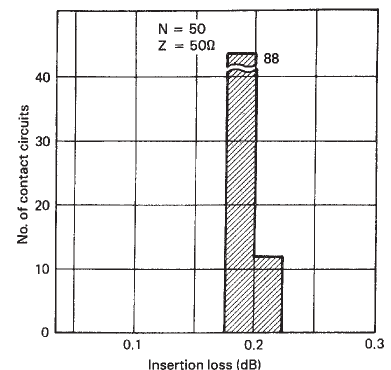

High-frequency characteristics (continued)

VSWR characteristics

G5Y-1

Frequency vs. return loss and VSWR

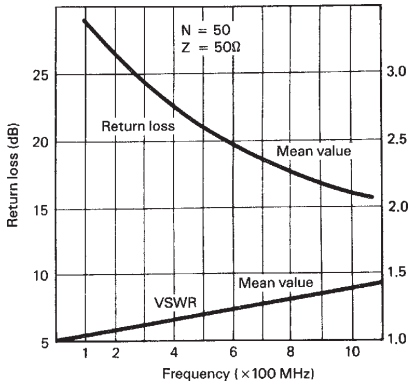

G5Y-1

Distribution of VSWR at 250 MHz

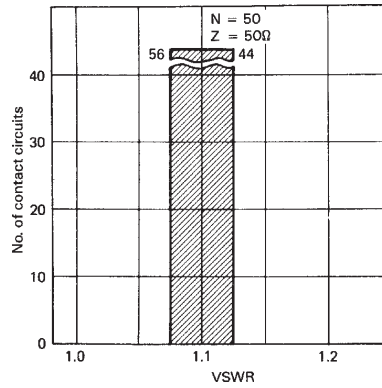

G5Y-1

Distribution of VSWR at 900 MHz

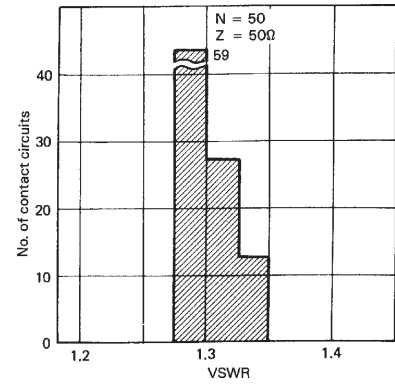

Ambient temperature vs. operate voltage

G5Y-1

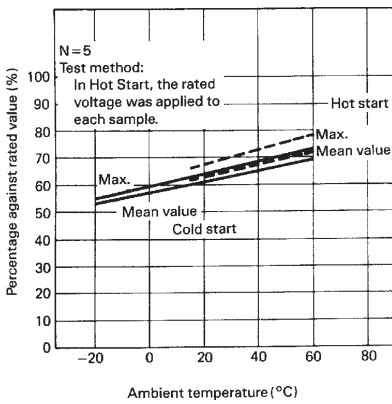

Coil temperature rise characteristics

Coil current consumption vs. temperature rise

G5Y-1

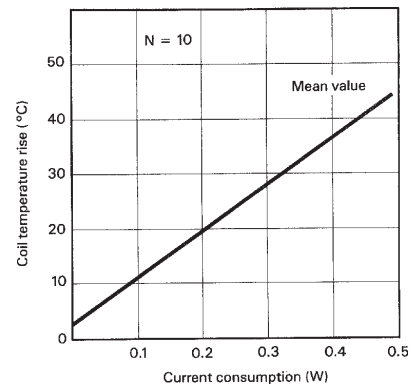

Shock resistance characteristics (unit: G)

G5Y-1

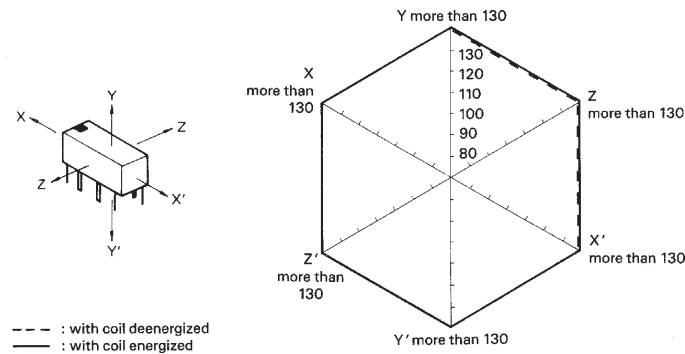

Dimensions

Unit: mm (inch)

■ RELAY

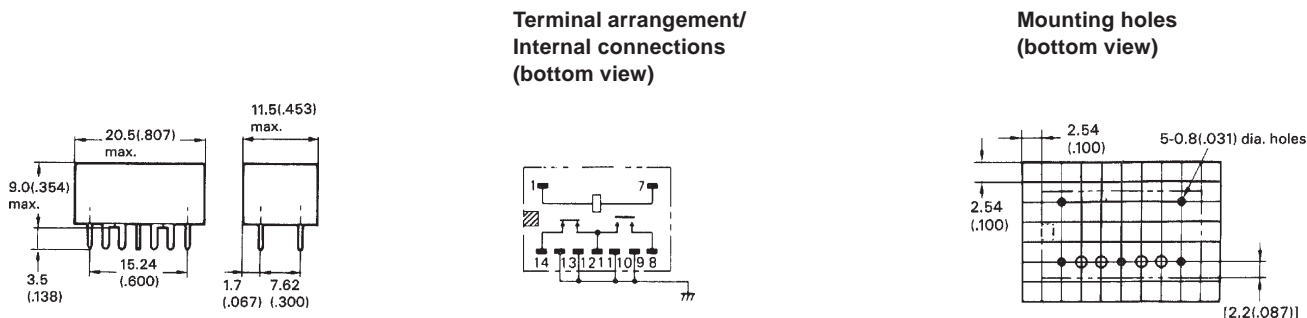

Note: Parts marked with and indicate mounting direction mark on G5Y relay.

Hints on Correct Use

How to design PC Board

■ PC BOARD SELECTION

Thickness of PC board

PC boards are generally available in the following thicknesses: 0.8 (0.03), 1.0 (0.04), 1.2 (0.05), 1.6 (0.06), and 2.0 mm (0.08 in). In determining the thickness of the PC board to be used, the pattern widths of the microstrips must be taken into account. First, determine the applicable pattern widths based on the intended arrangement of components on the PC board. Then select the appropriate PC board thickness.

PC board material

The base materials of PC boards can be divided into two types: epoxy type and phenolic type. For high-frequency circuits, glass epoxy type double-sided PC boards are recommended because of their distinct dielectric constant and material stability. However, paper epoxy type or paper phenolic type single-sided PC boards may also be used if cost factor is essential. Refer to "Examples of packaging design" for mounting the relay on a single-sided PC board.

■ PATTERN DESIGN

Preparation for pattern design

Relay mounting direction

The mounting direction of each relay must be taken into account for the relay to function with maximum performance. Shock resistance is one of the representative relay performance characteristics greatly influenced by the relay mounting direction. Refer to the Shock Resistance Characteristic in "Characteristic Data" section.

Note that the shock resistance of a relay (NC contact), with its coil in the nonenergized state, is governed greatly by the mounting direction of the relay.

Terminal hole diameters, land diameters, and land shapes (DC circuit)

Terminal hole diameter and land diameter

Select the appropriate terminal hole diameter and land diameter from the following table based on the PC board mounting hole drawing. Land diameters may be reduced to less than those listed below if thru-hole connection process is to be employed.

Terminal hole diameters and land diameters

Unit: mm (inch)

Terminal hole diameter Nominal value	Minimum land diameter	Tolerance
0.6 (0.02)	1.5 (0.06)	± 0.1 (± 0.004)
0.8 (0.03)	1.8 (0.07)	
1.0 (0.04)	2.0 (0.08)	
1.2 (0.05)	2.5 (0.10)	
1.3 (0.05)		
1.5 (0.06)	3.0 (0.12)	
1.6 (0.06)		
2.0 (0.08)		

Shape of land

1. The land section should be on the center line of the copper-foil pattern so that the soldered fillets become uniform.

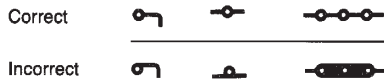

2. If the relay and other circuit components are to be soldered manually after the automatic soldering of the PC board, a terminal hole can be secured by providing a break in the land.



Conductor width and microstrip

Patterns for DC circuits

The following thicknesses of copper foil are standard: 35 μm (1.38 mil) and 70 μm (2.76 mil). The conductor width is determined by the carry current and allowable temperature rise. Refer to the table on the following page.

Conductor width and carry current (according to IEC Pub321)

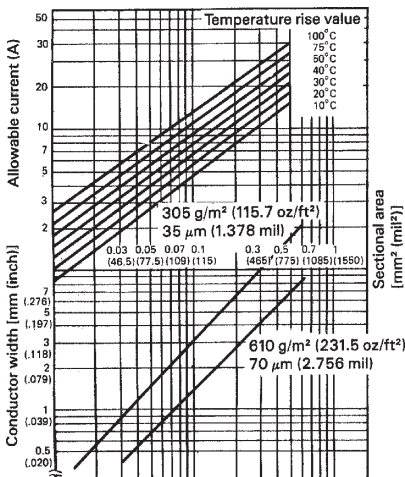

■ MICROSTRIPS

For high-frequency transmission circuits, the use of microstrips is recommended. By adopting this stripline method, a low-loss transmission circuit can be configured. The microstrips are prepared by etching a PC board made of dielectric material and covered on both sides with copper foil. As shown in the figure below, the microstrip utilizes the concentration of the electric field between transmission line and the ground.

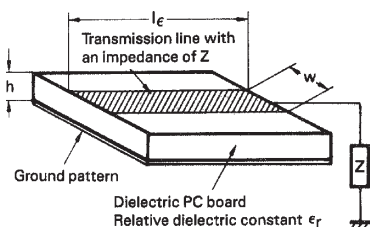

The characteristic impedance of a transmission line is determined by the type of PC board (specific inductive capacity), its thickness, and the width of the transmission line. This impedance is expressed by the following formula.

$$Z = 377 / \left(\frac{W}{h} \right) \cdot \sqrt{\epsilon_r} \cdot [1 + (1.735 \epsilon_r^{-0.0724}) \left(\frac{W}{h} \right)^{-0.836}]$$

where

- w: Width of transmission line
- εr: Relative dielectric constant εr
- h: Thickness of dielectric PC board, provided that the thickness of copper foil is no greater than h.

This relationship is shown the the figure below.

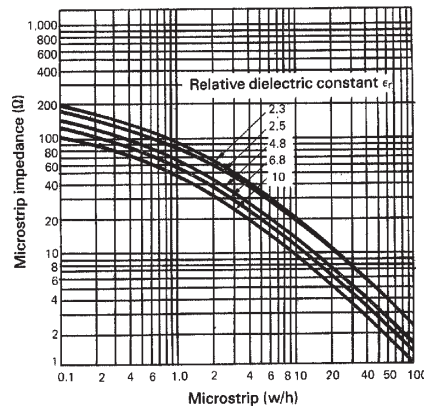

For example, when a 50Ω transmission line is to be formed using a 1.6 mm (0.06) glass epoxy type double-sided PC board, the width of the transmission line can be obtained in the following manner. Since the specific inductive capacity (εr) of this circuit board is 4.8, w/h = 1.7 (obtained from the above table). Based on the thickness of the PC board (e.g., 1.6 mm [0.06]), the thickness of transmission line w can be calculated as follows.

$$w = h \times 1.7 = 1.6 (0.06) \times 1.7 \approx 2.7 \text{ mm } (0.11 \text{ in})$$

Note that in this calculation, the thickness of copper foil "t" is ignored, so there may be a greater error in characteristic impedance of t ≈ w. Also, the attenuation constant of the transmission line, due to the effective filling rate of microstrip or dielectric loss and conductor loss, is not taken into account, but these factors must be considered in the actual design of microstrips. In the frequency band for which Model G5Y is intended, however, these factors may be ignored by shortening the length of the transmission line.

Bending of strip transmission line

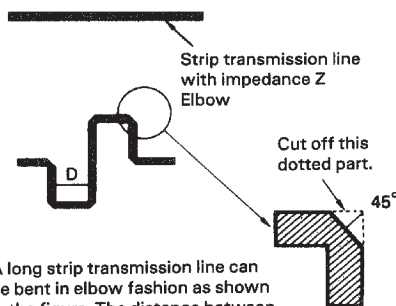

A long strip transmission line can be bent in elbow fashion as shown in the figure. The distance between the bends of the strip line (D) should be almost double the width of the strip line.

The separation between the strip line and each ground pattern should be approximately the same as the strip line width.

- Conductive patterns should be designed to be as short as possible. Meandering of the strip transmission line will adversely affect the high-frequency characteristics of the relay.
- Each ground pattern should be designed to be as wide as possible so as not to generate a potential difference between ground patterns.
- Avoid directing of conductive lines in the area of the PC board on which the relay bottoms, as this can result in short-circuiting.

EXAMPLES OF PACKAGING DESIGN

Since these examples are presented with an eye to low cost packaging, expensive packaging methods, such as thru-hole connection, are not described. For this reason, the characteristics of each circuit board should be checked thoroughly before putting it to practical use.

The method of packaging using paper epoxy type double-sided PC board.

The dielectric constant of a paper epoxy type double-sided PC board is considered to be approximately the same as that of a glass epoxy type PC board

($\epsilon_r = 4.8$).

The width of a strip transmission line is as follows:

Unit mm (inch)

Thickness of PC board	Impedance (Ω)	Width of strip line
1.6 (0.06)	50	2.7 (0.11)
	75	1.3 (0.05)
1.0 (0.04)	50	1.7 (0.07)
	75	0.8 (0.03)

HOW TO DESIGN PC BOARD

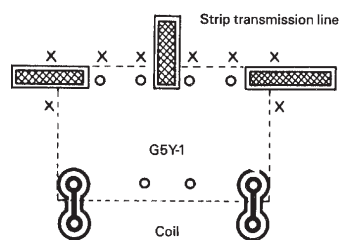

The figure above shows the conductive pattern side. The microstrip connected to the contact terminal must be of the above-mentioned pattern width. Ensure that the distance between microstrip and each ground pattern is approximately the same as the width of the microstrip. Connect with jumpers between the top and bottom of the pattern at the points marked "X" in the figure. The greater the number of jumper points, the better the high-frequency characteristics. In this manner, an isolation of 65 to 75 dB at 500 MHz or 50 dB at 900 MHz can be obtained. In this case, the components mounting side of the PC board is entirely the ground pattern. Remove the pattern around each of the contact terminals and coil terminal in size 2.0x2.0 mm (0.08 x 0.08 in).

The method of packaging using a single-sided PC board

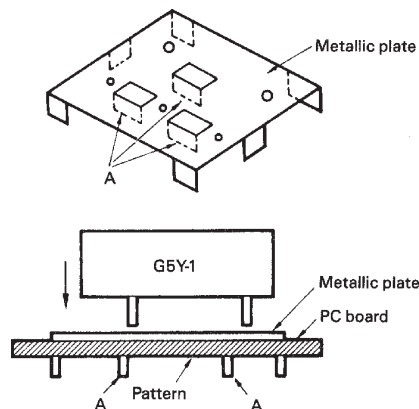

When a relay is mounted on a single-sided PC board, an isolation of only 60 to 70 dB can be obtained at 200 MHz. Therefore, to permit the relay on the single-sided PC board in a higher frequency range, a metallic plate can be inserted between the PC board and the relay, then connected to the ground pattern.

As seen in the figure to the left, a metallic plate is sandwiched between the relay and the PC board to connect to the pattern. The key is that the ground terminal of the Type G5Y-1 relay, the bent tabs A of the metallic plate, and the ground pattern must be soldered together at one time.

This combination of a low-cost, single-sided PC board and a low-cost, metallic plate, provides the same high-frequency characteristics as when the relay is mounted on a double-sided PC board.

By grounding the ground terminal of the Type G5Y-1 relay and the metallic plate at the same place, excellent high-frequency characteristics can be obtained.

In this method, the metallic plate must adhere firmly to the PC board. The design of strip transmission lines should be the same as when a double-sided PC board is employed.

CAUTION:

A key point in mounting the relay on a single-sided PC board is to ensure that the relay base is not floating above the PC board or metallic plate, but bottoms firmly upon them.

Note: In the interest of product improvement, specifications are subject to change.



OMRON ELECTRONICS, INC.
One East Commerce Drive
Schaumburg, IL 60173
1-800-55-OMRON

OMRON CANADA, INC.
885 Milner Avenue
Scarborough, Ontario M1B 5V8
416-286-6465