

SPECIFICATIONS:

ELECTRICAL:
 INSULATOR RESISTANCE: 5 G OHMS Min.
 DIELECTRIC WITHSTANDING: 1,000VAC r.m.s.
 OPERATING TEMPERATURE: -55° C ~ +125° C
 POWER CONTACT RESISTANCE: 1.0 Milliohms Max.
 SIGNAL CONTACT RESISTANCE: 2.7 Milliohms Max.
 POWER PINS: SEE PART No. BELOW
 SIGNAL PINS: 5 AMPS

MECHANICAL:
 CONTACT INSERTION FORCE: 4.5 Kg Max.
 CONTACT SEPARATOR FORCE: 0.3Kg Min.

MATERIALS:
 CONTACTS: COPPER ALLOY
 INSULATOR: PBT UL94V-0 RATED, BLK
 230°C PROCESS TEMP.
 SHELL: STEEL

FINISH:
 SHELL: NICKEL
 CONTACTS: FULL GOLD FLASH

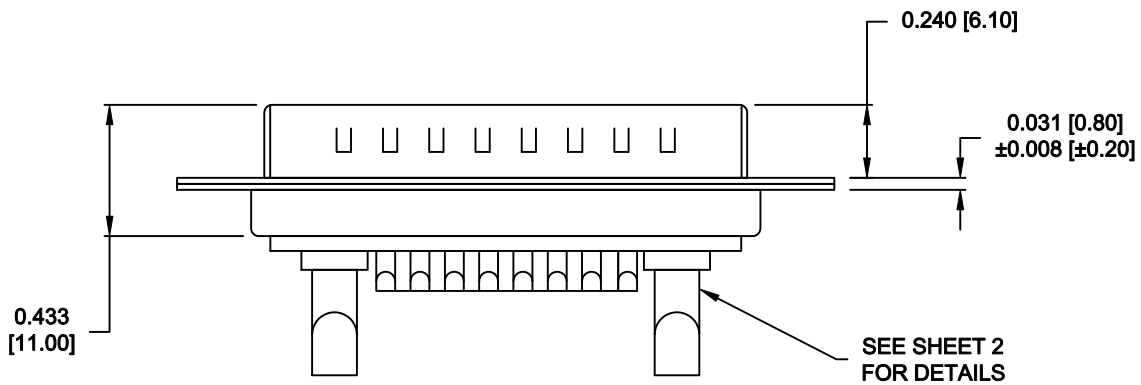
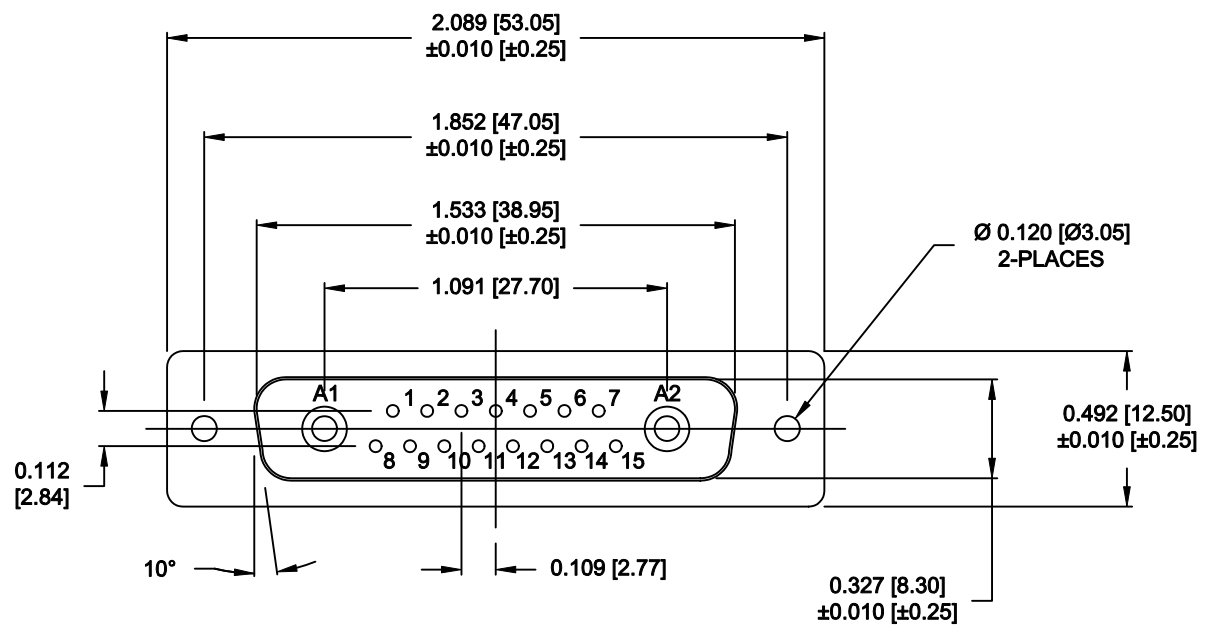

680M17W2103LYY1

20 = 20 AMPS
 40 = 40 AMPS

RoHS COMPLIANT

	THESE DRAWINGS AND SPECIFICATIONS ARE THE PROPERTY OF NorComp AND SHALL NOT BE REPRODUCED, COPIED OR USED AS THE BASIS FOR THE MANUFACTURE OR SALE OF APPARATUS WITHOUT WRITTEN PERMISSION.		DRAWN: M. SIGMON	DATE: 11-13-12
			CHECKED:	DATE:
NorComp	SCALE: 1.5 = 1	SHEET 1 OF 2	REV 1	
	DWG NO. 680M17W2103LYY1			

NOTE:
SIGNAL AND POWER CONTACTS
COME PRE-LOADED INTO INSULATORS

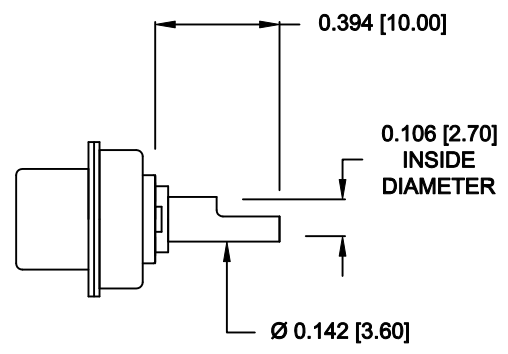

20 AMP POWER CONTACTS
ACCEPTS UP TO 12 AWG WIRE

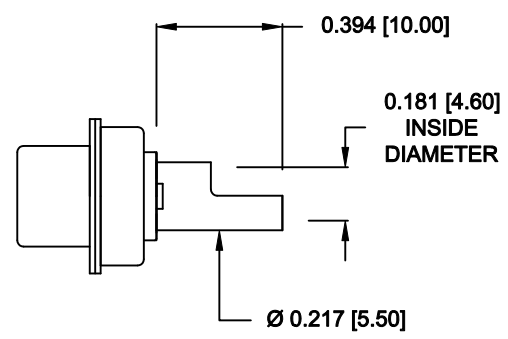

40 AMP POWER CONTACTS
ACCEPTS UP TO 8 AWG WIRE

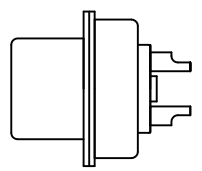

SIGNAL CONTACTS
ACCEPTS UP TO 20 AWG WIRE

RoHS COMPLIANT

	THESE DRAWINGS AND SPECIFICATIONS ARE THE PROPERTY OF NorComp AND SHALL NOT BE REPRODUCED, COPIED OR USED AS THE BASIS FOR THE MANUFACTURE OR SALE OF APPARATUS WITHOUT WRITTEN PERMISSION.		DRAWN: M. SIGMON	DATE: 11-13-12
			CHECKED:	DATE:
NorComp		SCALE: 1.5 = 1	SHEET 2 OF 2	REV 1
		DWG NO. 680M17W2103LYY1		