



Tire Pressure Monitoring System User's Guide

Note the following details of the code protection feature on Microchip devices:

- Microchip products meet the specification contained in their particular Microchip Data Sheet.
- Microchip believes that its family of products is one of the most secure families of its kind on the market today, when used in the intended manner and under normal conditions.
- There are dishonest and possibly illegal methods used to breach the code protection feature. All of these methods, to our knowledge, require using the Microchip products in a manner outside the operating specifications contained in Microchip's Data Sheets. Most likely, the person doing so is engaged in theft of intellectual property.
- Microchip is willing to work with the customer who is concerned about the integrity of their code.
- Neither Microchip nor any other semiconductor manufacturer can guarantee the security of their code. Code protection does not mean that we are guaranteeing the product as "unbreakable."

Code protection is constantly evolving. We at Microchip are committed to continuously improving the code protection features of our products. Attempts to break Microchip's code protection feature may be a violation of the Digital Millennium Copyright Act. If such acts allow unauthorized access to your software or other copyrighted work, you may have a right to sue for relief under that Act.

Information contained in this publication regarding device applications and the like is provided only for your convenience and may be superseded by updates. It is your responsibility to ensure that your application meets with your specifications. MICROCHIP MAKES NO REPRESENTATIONS OR WARRANTIES OF ANY KIND WHETHER EXPRESS OR IMPLIED, WRITTEN OR ORAL, STATUTORY OR OTHERWISE, RELATED TO THE INFORMATION, INCLUDING BUT NOT LIMITED TO ITS CONDITION, QUALITY, PERFORMANCE, MERCHANTABILITY OR FITNESS FOR PURPOSE. Microchip disclaims all liability arising from this information and its use. Use of Microchip devices in life support and/or safety applications is entirely at the buyer's risk, and the buyer agrees to defend, indemnify and hold harmless Microchip from any and all damages, claims, suits, or expenses resulting from such use. No licenses are conveyed, implicitly or otherwise, under any Microchip intellectual property rights.

Trademarks

The Microchip name and logo, the Microchip logo, Accuron, dsPIC, KEELOQ, microID, MPLAB, PIC, PICmicro, PICSTART, PRO MATE, PowerSmart, rPIC and SmartShunt are registered trademarks of Microchip Technology Incorporated in the U.S.A. and other countries.

Amplab, FilterLab, Migratable Memory, MXDEV, MXLAB, SEEVAL, SmartSensor and The Embedded Control Solutions Company are registered trademarks of Microchip Technology Incorporated in the U.S.A.

Analog-for-the-Digital Age, Application Maestro, CodeGuard, dsPICDEM, dsPICDEM.net, dsPICworks, ECAN, ECONOMONITOR, FanSense, FlexROM, fuzzyLAB, In-Circuit Serial Programming, ICSP, ICEPIC, Linear Active Thermistor, Mindi, MiWi, MPASM, MPLIB, MPLINK, PICkit, PICDEM, PICDEM.net, PICLAB, PICtail, PowerCal, PowerInfo, PowerMate, PowerTool, REAL ICE, rLAB, rPICDEM, Select Mode, Smart Serial, SmartTel, Total Endurance, UNI/O, WiperLock and ZENA are trademarks of Microchip Technology Incorporated in the U.S.A. and other countries.

SQTP is a service mark of Microchip Technology Incorporated in the U.S.A.

All other trademarks mentioned herein are property of their respective companies.

© 2006, Microchip Technology Incorporated, Printed in the U.S.A., All Rights Reserved.

 Printed on recycled paper.

QUALITY MANAGEMENT SYSTEM
CERTIFIED BY DNV
== ISO/TS 16949:2002 ==

Microchip received ISO/TS-16949:2002 certification for its worldwide headquarters, design and wafer fabrication facilities in Chandler and Tempe, Arizona, Gresham, Oregon and Mountain View, California. The Company's quality system processes and procedures are for its PICmicro® 8-bit MCUs, KEELOQ® code hopping devices, Serial EEPROMs, microperipherals, nonvolatile memory and analog products. In addition, Microchip's quality system for the design and manufacture of development systems is ISO 9001:2000 certified.



TIRE PRESSURE MONITORING SYSTEM USER'S GUIDE

Table of Contents

Preface	1
Introduction.....	1
Document Layout	1
Conventions Used in this Guide	2
Recommended Reading.....	3
The Microchip Web Site	3
Customer Support	4
Document Revision History	4
Chapter 1. Quick Start Instructions	5
1.1 Introduction	5
Chapter 2. System Overview	9
2.1 System Technical Specifications	9
2.2 Operation Overview	9
2.3 Network Setup Overview	10
Chapter 3. Hardware Overview	11
3.1 Introduction	11
3.2 Base Station Module Overview	11
3.3 Low Frequency Initiator Module	13
3.4 Transponder Sensor Module	14
3.5 Analog Sensor Calibration	19
3.6 Sensor Calibration	19
Appendix A. Schematic and Layouts	23
A.1 Introduction	23
A.2 Base Station Module Schematic (Page 1)	24
A.3 Base Station Module Schematic (Page 2)	25
A.4 Base Station Wiring Harness - Schematic	26
A.5 Base Station Module - Top Layer and Silk Screen	27
A.6 Base Station Module - Bottom Layer	27
A.7 Low Frequency Initiator Module - Schematic	28
A.8 Low Frequency Initiator Module - Top Layer and Silk Screen	29
A.9 Low Frequency Initiator Module - Bottom Layer	29
A.10 Transponder Sensor Module - Schematic	30
A.11 Transponder Sensor Module - Top Layer and Silk Screen	31
A.12 Transponder Sensor Module - Bottom Layer	31
A.13 Circuit Block Figure	32

Tire Pressure Monitoring System User's Guide

Appendix B. Bill Of Materials (BOM)	33
Worldwide Sales and Service	38



TIRE PRESSURE MONITORING SYSTEM USER'S GUIDE

Preface

NOTICE TO CUSTOMERS

All documentation becomes dated, and this manual is no exception. Microchip tools and documentation are constantly evolving to meet customer needs, so some actual dialogs and/or tool descriptions may differ from those in this document. Please refer to our web site (www.microchip.com) to obtain the latest documentation available.

Documents are identified with a “DS” number. This number is located on the bottom of each page, in front of the page number. The numbering convention for the DS number is “DSXXXXA”, where “XXXX” is the document number and “A” is the revision level of the document.

INTRODUCTION

This chapter contains general information that will be useful to know before using the Tire Pressure Monitor System. Items discussed in this chapter include:

- Document Layout
- Conventions Used in this Guide
- Recommended Reading
- The Microchip Web Site
- Customer Support
- Document Revision History

DOCUMENT LAYOUT

This document describes how to use the Tire Pressure Monitor System as a development tool. The manual layout is as follows:

- **Chapter 1. “Quick Start Instructions”** – includes instructions on how to connect the system together.
- **Chapter 2. “System Overview”** – shows an overview of the Tire Pressure Monitor System.
- **Chapter 3. “Hardware Overview”** – shows an overview of the hardware used in the Tire Pressure Monitor System.
- **Appendix A. “Schematic and Layouts”** – shows the schematic and board layout diagrams for the Tire Pressure Monitor System.
- **Appendix B. “Bill Of Materials (BOM)”** – lists the parts used to build the Tire Pressure Monitor System boards.

Tire Pressure Monitoring System User's Guide

CONVENTIONS USED IN THIS GUIDE

This manual uses the following documentation conventions:

DOCUMENTATION CONVENTIONS

Description	Represents	Examples
Arial font:		
Italic characters	Referenced books	<i>MPLAB® IDE User's Guide</i>
	Emphasized text	...is the <i>only</i> compiler...
Initial caps	A window	the Output window
	A dialog	the Settings dialog
	A menu selection	select Enable Programmer
Quotes	A field name in a window or dialog	"Save project before build"
Underlined, italic text with right angle bracket	A menu path	<u><i>File>Save</i></u>
Bold characters	A dialog button	Click OK
	A tab	Click the Power tab
N'Rnnnn	A number in verilog format, where N is the total number of digits, R is the radix and n is a digit.	4'b0010, 2'hF1
Text in angle brackets < >	A key on the keyboard	Press <Enter>, <F1>
Courier New font:		
Plain Courier New	Sample source code	#define START
	Filenames	autoexec.bat
	File paths	c:\mcc18\h
	Keywords	_asm, _endasm, static
	Command-line options	-Opa+, -Opa-
	Bit values	0, 1
	Constants	0xFF, 'A'
Italic Courier New	A variable argument	<i>file.o</i> , where <i>file</i> can be any valid filename
Square brackets []	Optional arguments	mcc18 [options] <i>file</i> [options]
Curly brackets and pipe character: { }	Choice of mutually exclusive arguments; an OR selection	errorlevel {0 1}
Ellipses...	Replaces repeated text	var_name [, var_name...]
	Represents code supplied by user	void main (void) { ... }

RECOMMENDED READING

This user's guide describes how to use Tire Pressure Monitor System. The following Microchip documents are available and recommended as supplemental reference resources.

- MCP201 Data Sheet, “LIN Transceiver with Voltage Regulator” (DS21730)**
- MCP2030 Data Sheet, “Three-Channel Analog Front-End Device” (DS21981)**
- HCS365 Data Sheet “KEELOQ® Code Hopping Encoder” (DS41109)**
- MCP3550/1/3 Data Sheet, “Low-Power Single Channel 22-Bit Delta Sigma ADCs” (DS21950)**
- TC4421/22 Data Sheet, “9A High-Speed Mosfet Drivers” (DS21420)**
- AN232, “Low Frequency Magnetic Transmitter Design” (DS00232)**
- AN617, “Fixed Point Routines” (DS00617)**
- AN695, “Interfacing Pressure Sensors to Microchip's Analog Peripherals” (DS00695)**
- AN990, “Analog Sensor Conditioning Circuits - An Overview” (DS00990)**
- AN1009, “LIN 2.0 Compliant Driver Using the PIC18XXXX” (DS01009)**
- Passive Keyless Entry (PKE) Reference Design User's Manual (21986)**
- LIN Specification Package, Revision 1.3 (<http://www.lin-subbus.org>)**

THE MICROCHIP WEB SITE

Microchip provides online support via our web site at www.microchip.com. This web site is used as a means to make files and information easily available to customers. Accessible by using your favorite Internet browser, the web site contains the following information:

- **Product Support** – Data sheets and errata, application notes and sample programs, design resources, user's guides and hardware support documents, latest software releases and archived software
- **General Technical Support** – Frequently Asked Questions (FAQs), technical support requests, online discussion groups, Microchip consultant program member listing
- **Business of Microchip** – Product selector and ordering guides, latest Microchip press releases, listing of seminars and events, listings of Microchip sales offices, distributors and factory representatives

Tire Pressure Monitoring System User's Guide

CUSTOMER SUPPORT

Users of Microchip products can receive assistance through several channels:

- Distributor or Representative
- Local Sales Office
- Field Application Engineer (FAE)
- Technical Support
- Development Systems Information Line

Customers should contact their distributor, representative or field application engineer for support. Local sales offices are also available to help customers. A listing of sales offices and locations is included in the back of this document.

Technical support is available through the web site at: <http://support.microchip.com>

DOCUMENT REVISION HISTORY

Revision A (August 2006)

- Initial Release of this Document.

Chapter 1. Quick Start Instructions

1.1 INTRODUCTION

This section provides the user a quick step-by-step instruction guide on how to get the Tire Pressure Monitor System operational.

1. Connect the Base Station module (J2) with the Low Frequency (LF) Initiator module (J4) with the connector cable provided with the kit to establish the Local Interconnect Network (LIN) physical connections.

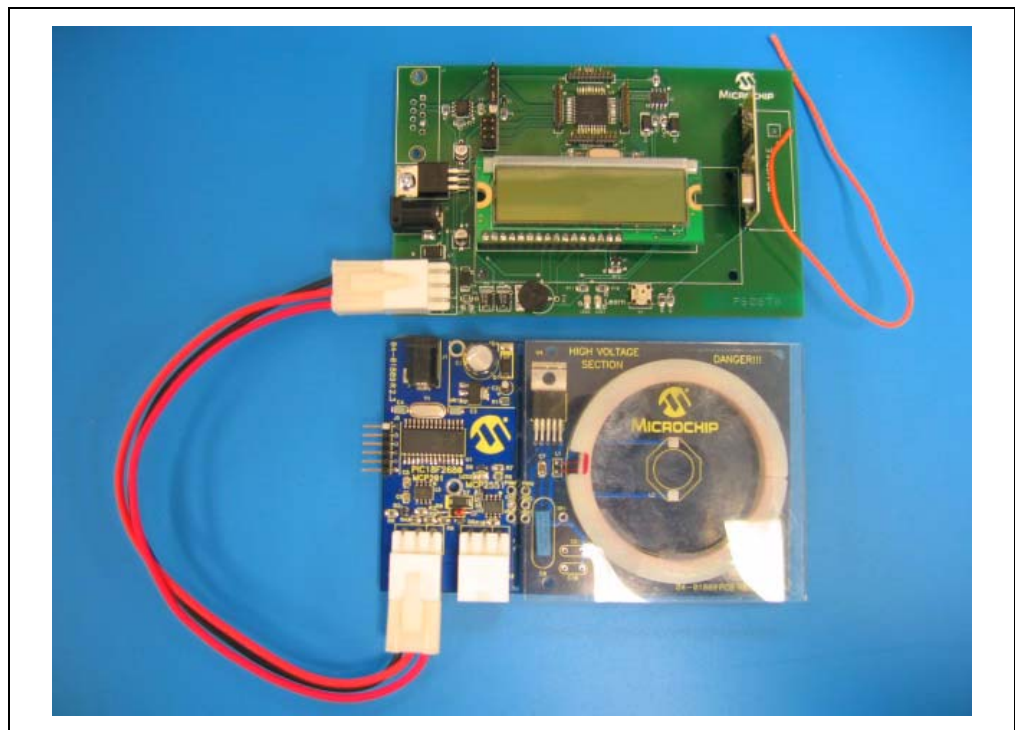

Note: This reference design provides only the typical calibration values used during development. Therefore, the accuracy of the measurements is not guaranteed. The user is responsible for performing the calibration routine for their applications. Please contact sensor manufacturing for additional information regarding this topic.

Tire Pressure Monitoring System User's Guide

2. Apply power to the Sensor module by inserting a 3V NiHM (CR2320) battery. The LED will light to indicate that the power is supplied.

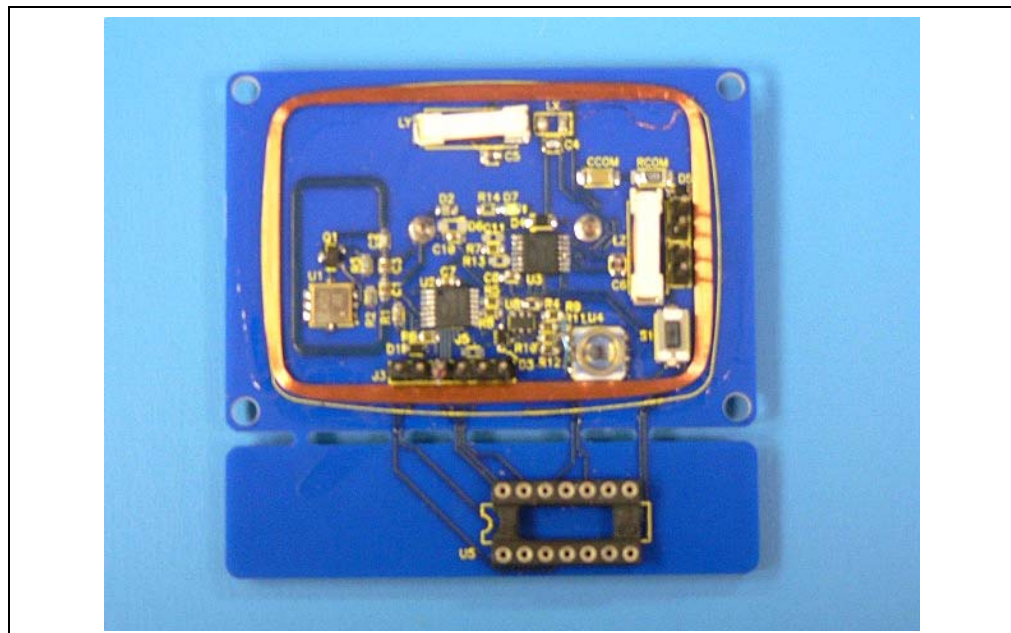
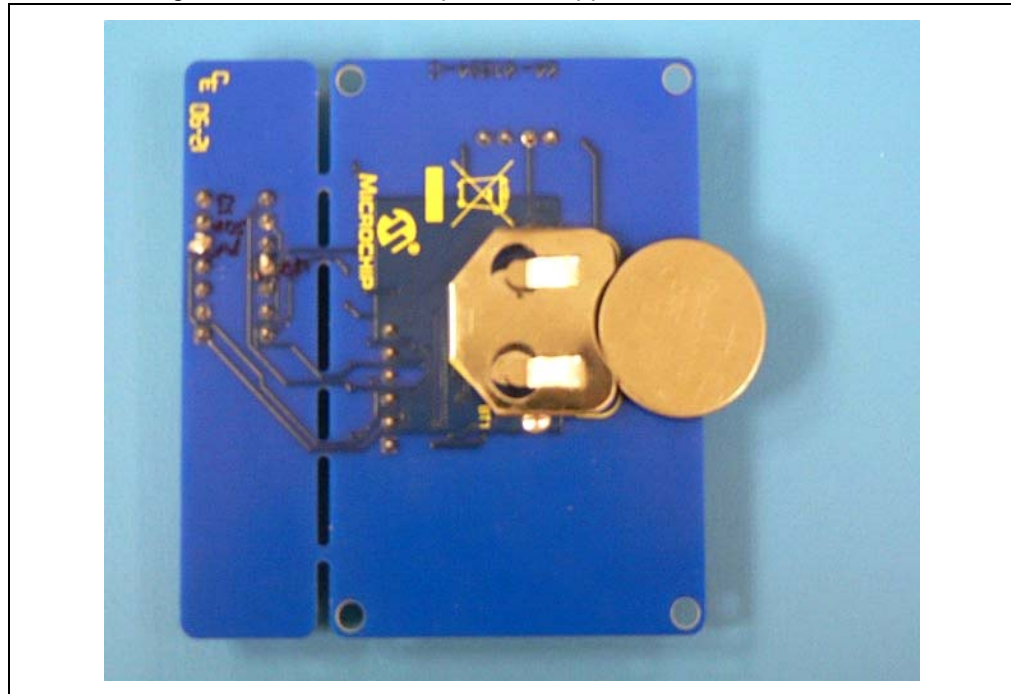

Quick Start Instructions

- Supply power to either the Base Station module or the LF Initiator module with a 9V - 18V supply. Only one power source is needed if the power is shared on the LIN network. The LEDs will light to indicate that the power is connected.

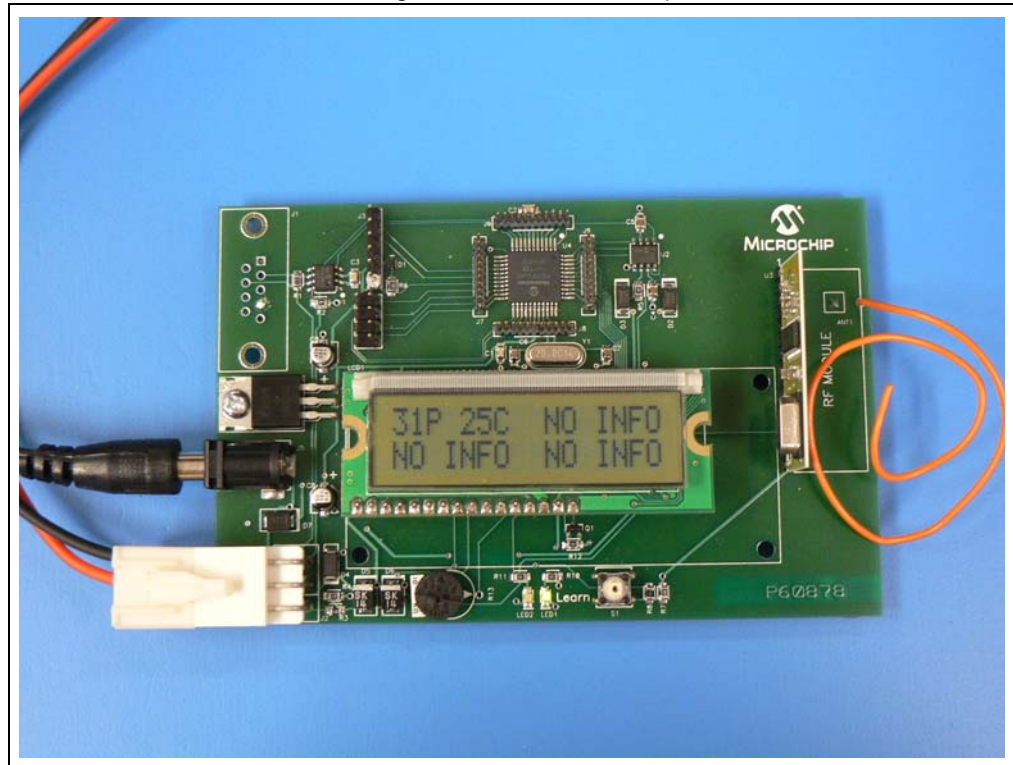

- The LCD module should be powered at this time. The pressure and temperature data is displayed on the LCD for each Sensor module connected to the LIN network. Check power and connection if no information is shown.

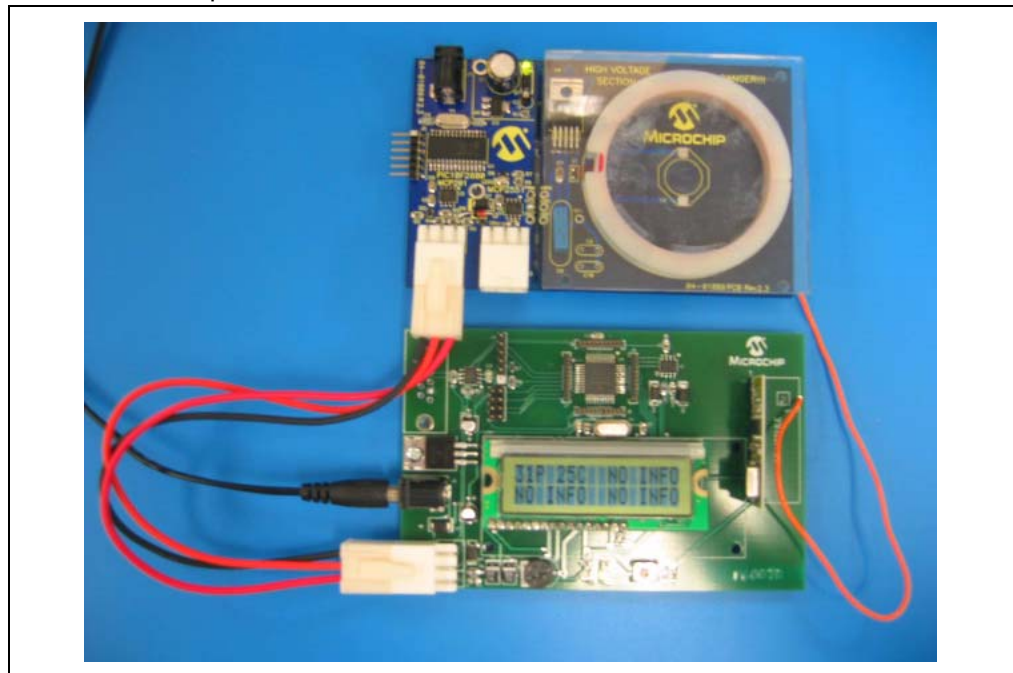

Tire Pressure Monitoring System User's Guide

NOTES:

Chapter 2. System Overview

2.1 SYSTEM TECHNICAL SPECIFICATIONS

UHF Communication Frequency:	433.92 MHz
LF Communication Frequency:	125 kHz
Network Connectivity:	LIN or CAN, LIN is used in the design
Modulation Format:	ASK
Encoding Method:	PWM

2.2 OPERATION OVERVIEW

The Base Station wakes up the Sensor modules in each tire through the Low Frequency Initiator to poll the pressure, temperature data and checks the battery level in a sequential manner. The Base Station communicates to the LF initiator via the LIN network. The LF initiator transmits a wake up challenge via a 125 kHz ASK modulated signal to the Tire sensor module after a command has been received from the Base Station. The 3-axis Analog Front End (MCP2030) of the Tire Sensor module validates the incoming challenge and wakes up the microcontroller from sleep only if the preambles match. The Tire Sensor module will then measure the pressure and the temperature, check the battery level and transmits the data to the Base Station via a 433.9 MHz signal. The Base Station will display the information on the LCD after receiving the data.

The Base Station module contains a PIC18F4680. It is also implemented with a MCP201 LIN Transceiver and MCP2551 CAN Transceiver for communications via LIN or CAN.

The LF Initiator module contains a PIC18F2680. The module also contains a MCP201 and MCP2551 for LIN or CAN communication.

The Tire Sensor module contains a PIC16F684 with a MCP2030, a three-axis Analog Front-End (AFE). The analog pressure sensor used is the MS5407-AM from Intersema.

Tire Pressure Monitoring System User's Guide

FIGURE 2-1: COMPLETE TIRE PRESSURE MONITORING SYSTEM

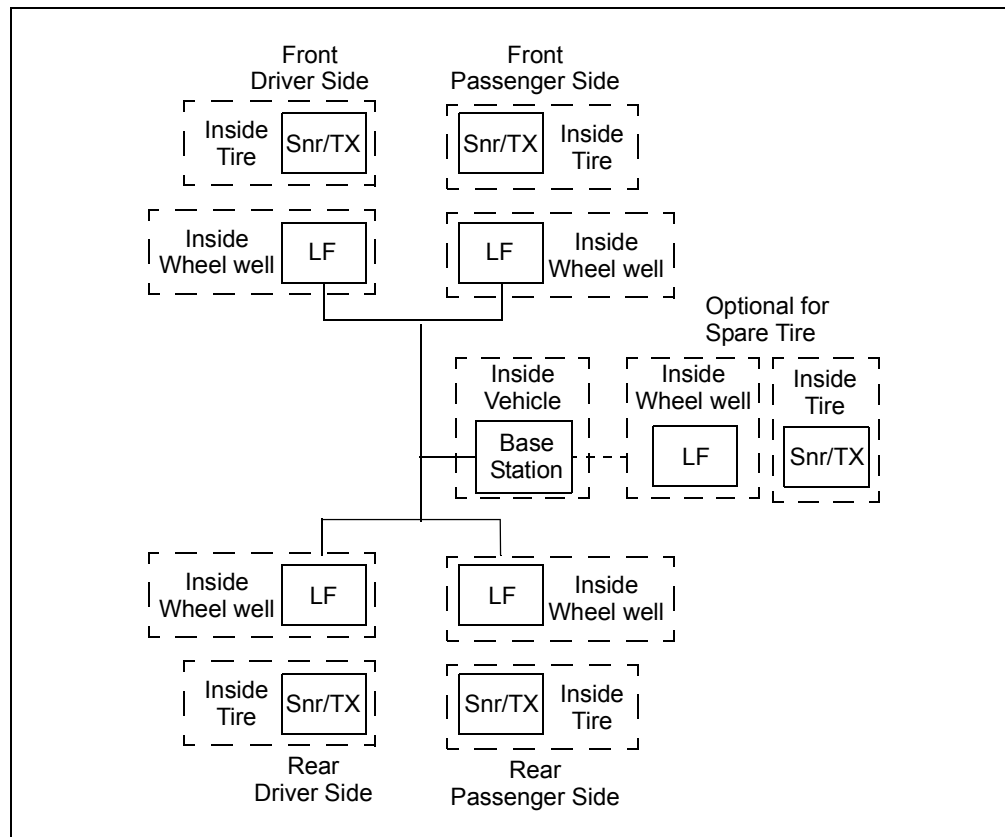

2.3 NETWORK SETUP OVERVIEW

The reference kit provides one wiring harness for LIN connectivity between the Base Station Module and one Low Frequency Initiator Module. Refer to **A.4 “Base Station Wiring Harness - Schematic”** in **Appendix A. “Schematic and Layouts”** for the wiring harness schematic. The user must provide or modify the wiring harness in order to build a complete TPMS network via LIN. Refer to Figure 2-2 for more information.

FIGURE 2-2: WIRING HARNESS FOR COMPLETE TPMS NETWORK

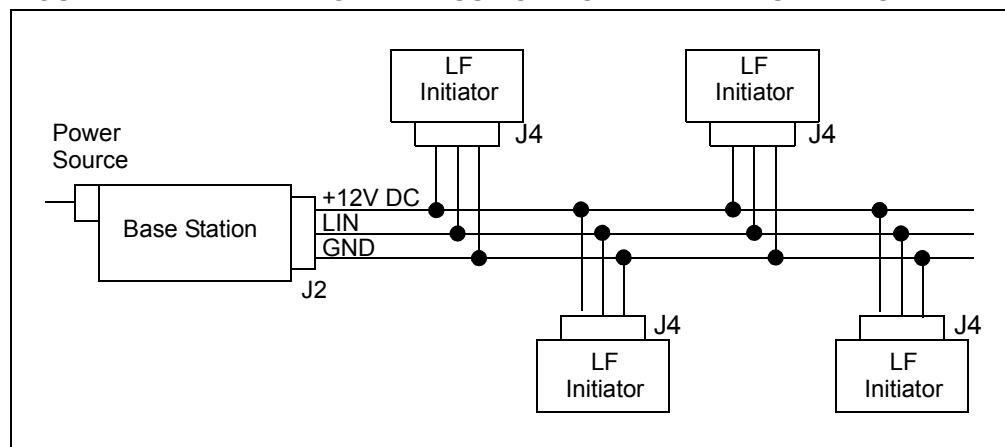

Chapter 3. Hardware Overview

3.1 INTRODUCTION

The following section provides an overview of the hardware used in the Tire Pressure Monitoring System.

3.2 BASE STATION MODULE OVERVIEW

3.2.1 Technical Specifications

UHF Receiving Frequency:	433.92 MHz
Normal Operating Voltage:	9 - 18V
Normal Operating Current:	~ 64 mA
Communication Protocols:	CAN and LIN
Liquid Crystal Display (LCD):	2x16

3.2.2 Microcontroller

The microcontroller implemented is a PIC18F4680 for this module based on the number of features offered by this device. The PIC18F4680 has both a CAN controller and a LIN compatible EUSART to interface to in-vehicle networks.

3.2.3 UHF Receiver

The RF input is an AM super-regenerative compact hybrid module, that is used to capture decoded data from an AM Transmitter. The receiver has very high frequency stability over a wide operating temperature and tolerant of mechanical vibrations or manual handling. A laser trimmed on board inductor, removes the need for any adjustable components.

3.2.4 LCD

A standard 16 pin 2x16 monochrome LCD is used to display the tire pressure and temperature data.

3.2.5 Connectivity

A MCP201 LIN transceiver and a MCP2551 CAN transceiver are provided on board to provide a way of connecting to LIN or CAN networks. This reference design uses the LIN to communicate between the Base Station and the LF Initiator(s) that is/are connected to the LIN network. The capacitor between the LIN bus pin and ground should have its value adjusted for the particular network topology. A large pull-up resistor on the nFault/SLPS pin ensures that the device resets to a standard slope control profile. Refer to the MCP201 Data Sheet, "*LIN Transceiver with Voltage Regulator*" (DS21730) for more information. Refer to **Appendix A. "Schematic and Layouts"**.

Tire Pressure Monitoring System User's Guide

3.2.6 Operation Overview

The Base Station schedules when each tire is polled. The Base Station transmits the command to wake up the Transponder Sensor module to each LF Initiators individually on the LIN network. The command issued to LF Initiator contains a unique ID that was pre-assigned to each Initiator. This command will be issued maximum of three times if the previous attempt failed. The LF Initiator transmits a wake up command containing the two bytes of data from the base station to the Transponder Sensor module. The Base Station will then wait for an incoming RF data message stream from the Transponder Sensor module which will also contain the LF Initiator ID to distinguish the tire position.

FIGURE 3-1: LIN MESSAGE COMMAND

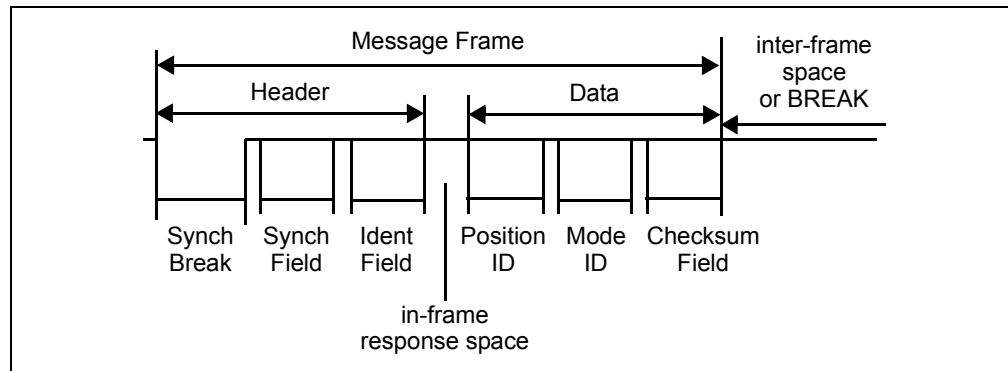

When the Learn Button (S1) is pressed, the Base Station places a Learn Mode ID in the second data byte of the message. The Base Station then issues the learn command sequentially to each LF initiator which in turn, transmits the command to the Transponder Sensor module. The Base Station waits for the Transponder Sensor to transmit back a message via UHF (the number of LF Initiators on the LIN network will determine how many messages to be expected by the Base Station and this must be defined by the user in the firmware). After a predetermined time has expired, an error message is displayed on the LCD if all the expected messages are not received.

3.3 LOW FREQUENCY INITIATOR MODULE

3.3.1 Technical Specifications

LF Transmitting Frequency:	125 kHz
Connectivity:	LIN or CAN, LIN is used for this design

3.3.2 System Overview

The LF Transmitter is derived from the design described in Application Note AN232, "*Low Frequency Magnetic Transmitter Design*" (DS00232).

The hardware design of the LF Initiator module is identical to the LF module used in Microchip PKE reference design (APGRD001). Refer to Chapter 2 of the "**PKE Reference Design User Guide**" for more information on this module. Refer to **Appendix A. "Schematic and Layouts"**.

3.3.3 Operation Overview

LF Initiator is connected to Base Station Module through the LIN network. Each LF Initiator is assigned a unique ID which is also used by the system to distinguish the tire location during normal operation. Once a command from the Base Station has been received, the LF Initiator transmits a wake-up challenge to the Transponder Sensor module via a 125 kHz modulated signal. The format of the signal is user configurable and also depends on the configurations of the AFE output filter on the Transponder Sensor module.

Refer to **3.4.3.3 "LF Message Overview"** for detail description of the LF message formatting.

3.3.4 Reference Material

Refer to **Recommended Reading** in the **Preface** section.

Tire Pressure Monitoring System User's Guide

3.4 TRANSPONDER SENSOR MODULE

3.4.1 Technical Specifications

Modulation Format:	ASK
Encoding Method:	PWM
Operating Voltage:	2.3 - 3.3V
Low Voltage Alert Threshold:	2.3V
Stand By Current With 3 LF Input Channels Enabled (PIC & AFE):	~12 μ A
UHF Transmitting Frequency:	433.92 MHz
UHF Transmission Baud Rate (TE):	100, 200, 400, 800 μ s selectable, system default is 400 μ s
UHF Range:	~ 10 Meters
LF Frequency:	125 kHz
LF Input Sensitivity:	~3 mVPP
LF Range:	Up to 3 Meters
Pressure Sensor Type:	Analog
Pressure Sensor Range:	1-7 bars absolute
Pressure Sensor Temperature Range:	-40 - 125°C

3.4.2 Hardware Overview

3.4.2.1 MICROCONTROLLER

The microcontroller used is the PIC16F684. The internal 10-bit ADC is used for pressure, temperature and battery measurements. It also interfaces with the MCP2030 for configuration and LF communications. Other PICmicro MCUs can be selected based on design requirement.

3.4.2.2 LF RECEIVER (125 KHZ)

The LF signal processing is handled with the Microchip's three-channel Analog Front End (MCP2030). The MCP2030 has a user-configurable input filter to process the incoming LF challenges.

3.4.2.3 HF TRANSMITTER (433.9 MHZ)

The HF transmitter is used for transmitting data to the base station module. A surface mounted SAW resonator is used to generate the carrier frequency which is controlled by the output pin of the microcontroller.

3.4.2.4 PRESSURE SENSOR

The sensor implemented in this design is an analog pressure sensor (MS5407-AM) from Intersema. The two output of the sensor, V+ and V-, will output voltages levels that correspond to the changes in pressure. The sensor is powered by RA1 pin of the microcontroller and is in the off state when not taking measurement.

3.4.2.5 SENSOR SIGNAL AMPLIFICATION

The two outputs of the pressure sensors are connected to the differential gain circuitry using the MCP6273. The output of the differential gain signal is amplified by 10 and then passed into the 10-bit ADC module in the microcontroller for conversion. The gain of the signal is controlled by the values of R9, R10, R11 and R12. Refer to **A.13 "Circuit Block Figure"**.

3.4.2.6 POWER

The module is powered by a standard Lithium 3V coin cell battery.

To reduce power consumption, the LED used for indication should be removed to reduce the standby current consumption. The typical standby current without the LED is about 25 μ A (the sum of the power down current of the microcontroller and the active current of three-channel analog front end).

In addition, the LF Receiver has all three channels enabled and powered on all the time for incoming signal detection. One or two channels can be disabled or a periodic detection method can be implemented to further reduce the overall standby current usage. Refer to **Appendix A. "Schematic and Layouts"**.

3.4.3 Operation Overview

When the Transponder Sensor module receives a LF (125 kHz) wake up challenge message, the Analog Front End validates the incoming challenge. Only after a valid message has been received, the microcontroller is awakened from sleep mode. The action taken by the module is determined by the received commands. Normal request measures the tire pressure and temperature. Learn Mode request assigns a new ID to the sensor module for future operations prior to the measurements. The Transponder Sensor module then transmits the data to the base station via UHF (433.9 MHz) and returns to Sleep mode if no other interrupts were detected.

To reduce power consumption, the pressure sensor and the op-amp for signal amplifications are normally powered off. These two devices are powered on only during measurements.

Tire Pressure Monitoring System User's Guide

FIGURE 3-2: SENSOR MODULE FLOW CHART

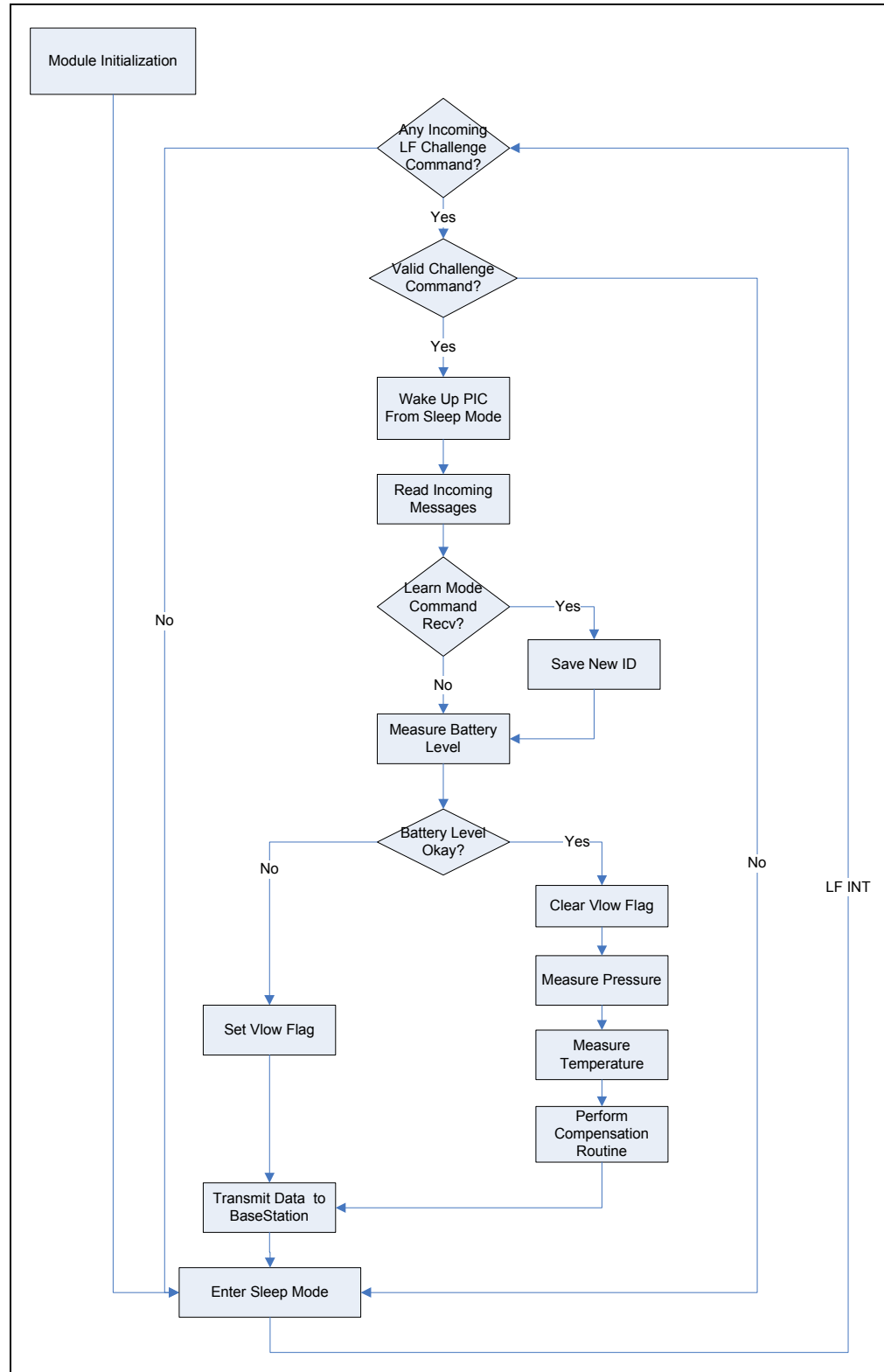

3.4.3.1 LEARN MODE OVERVIEW

When a Learn Mode ID is received, the module will save the new Tire Location ID and use it as its default ID for all future normal transmissions until another Learn Mode ID is received. This feature can be used to "re-learn" the tires after tire rotations or if a new Transponder Sensor module has been installed.

Note: Due to the possibility that one LF Initiator can wake up multiple Transponder Sensor modules in a full system setup (4 LF Initiators with 4 Sensor Modules) during development due to the close proximity, either the transmitting power of the LF Initiators should be reduced or the distance between the module sets (1 set = 1 LF Initiator + 1 Transponder Sensor) should be kept at a maximum where they will not cause interference with each other. Refer to Application Note AN232 for more details on the LF Transmitter.

3.4.3.2 ANALOG FRONT END OVERVIEW

The user configurable output filter of the MCP2030 is utilized to prevent the microcontroller from being awakened unnecessarily by either noise or LF signals from other unknown sources. The data is outputted to the microcontroller only when the preamble of the incoming message matches the pre-configured filter settings. The MCP2030 can be configured via SPI by writing to the seven configuration registers through the microcontroller. The number of channels enabled can also be controlled through these configuration registers. Refer to the MCP2030 data sheet (DS21981) for more information.

3.4.3.3 LF MESSAGE OVERVIEW

The incoming LF message from the LF Initiator Module consists of the following in a 125 kHz modulated format:

- A required minimum of 4 ms ON time for AGC stabilization
- A 500 μ s OFF delay
- A 2 ms ON time for the output filter (user configurable in AFE)
- A 2 ms OFF for the output filter time (user configurable in AFE)
- Two bytes of data (maximum of 8 bytes)
 - Tire Location ID (user defined)
 - System Mode ID (user defined)

FIGURE 3-3: LF MESSAGE FORMAT

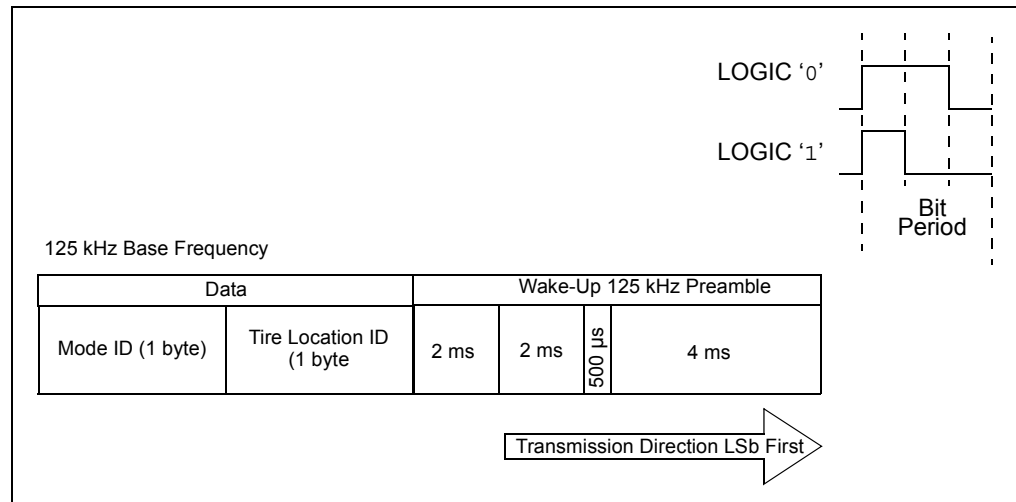

Tire Pressure Monitoring System User's Guide

3.4.3.4 RF MESSAGE OVERVIEW

The transmitted message follows the HCS365 PWM format via a 433 MHz carrier signal, which consists of:

- A preamble (31 TE, 50% duty cycle) for baud rate calculation on the receive side
- A header (4 or 10 Te, user selectable)
- Data bytes:
 - Tire Location ID (1 Byte, user defined)
 - Sensor ID (2 Bytes, user defined)
 - Pressure Data (2 Bytes)
 - Temperature Data (2 Bytes)
 - Battery Low Flag (1 Bit)
 - Dummy Bits (7 Bits)

Refer to the HCS365 data sheet (DS41109) for more information.

FIGURE 3-4: RF MESSAGE FORMAT

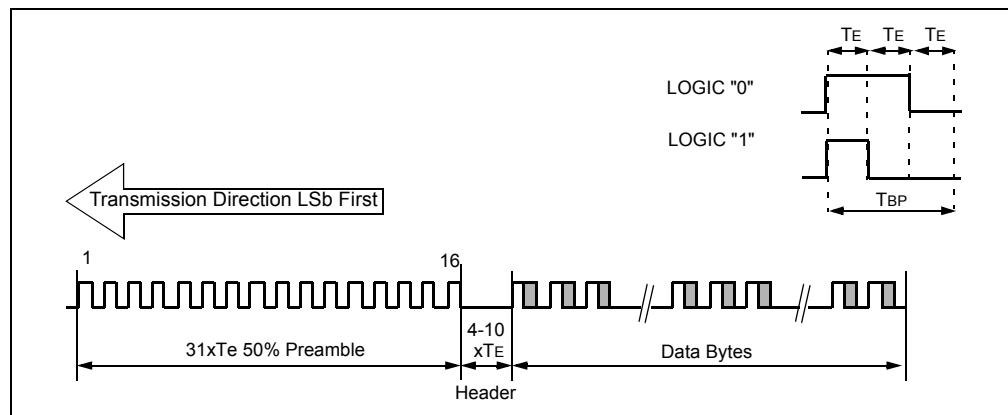

Note: For the next three sections, refer to **A.13 Circuit Block Figure in Appendix A. "Schematic and Layouts"** for circuit block diagram.

3.4.3.5 PRESSURE MEASUREMENT

- Drive pin RC0 and RA1 high to power up the sensor and the Op-Amp (MCP6273) that is used for signal amplification
- Enable the Op-Amp with pin RA5
- Pin RC2 is set up as the analog input to the internal ADC for pressure measurement

3.4.3.6 TEMPERATURE MEASUREMENT

- Drive pin RC0 pin high to power up the sensor and the op-amp used for signal amplification. This also pulls the sensor bridge high through R5. The R5 and the sensor bridge form a resistive divider which is monitored by the internal ADC through pin RA1. Since the sensor internal bridge resistance is temperature dependent, the voltage on the resistor divider will change accordingly.
- Pin RC0 is configured as the analog input of the internal ADC. Vref for the ADC is selected as internal which is equal to the battery voltage minus the diode drop.
- The recommended serial resistor (R5) value should be 10 kOhm or greater to minimize the influence of the parasitic of the microcontroller pins (about 200 Ohm).

Note: This method of the temperature measurement is not the most accurate way to monitor the temperature. An external temperature sensor should be used, if high accuracy is desired.

3.4.3.7 BATTERY MEASUREMENT

- The battery measurement is implemented by comparing the difference between the constant forward voltage drop of a diode (D3) with the battery voltage level using the internal ADC in the microcontroller. Pin RC1 is set up as the input to ADC for battery measurement. A threshold value of 2.3V is selected to ensure the proper operation of the internal ADC. The Battery Low flag will be set if the battery falls below the threshold value.

Note: The internal ADC minimum required Vref voltage is 2.2V. In order to achieve the 1LSB accuracy, Vref voltage value of 2.7V or higher is required.

3.5 ANALOG SENSOR CALIBRATION

The calibration method recommended by Intersema for the optimal sensor performance is the 4-point calibration routine using the simple linear sensor model described in the Intersema application note (AN402). Total of four independent measurements performed at two different temperatures and pressures are used to calculate and compensate for the variations in the performance of the sensor due to process variations. Refer to Application Note AN402 from Intersema for more details regarding analog sensor calibration methods.

Note: This reference design provides only the typical calibration values used during development and the calibration values will vary from unit to unit. Therefore, the accuracy of the measurements is not guaranteed. The user is responsible for performing the calibration routine for their applications. Please contact sensor manufacturing for additional information regarding this topic.

3.6 SENSOR CALIBRATION

The multiplication and division subroutines used in the sensor calibration/compensation routine are derived from the math subroutines described in Microchip's Application Note AN617, "Fixed Point Routines". Refer to this application note for more descriptions on the 16x16 bits multiplication and 32/16 bits division routines. The flow charts for the addition routine (Figure 3-6) and subtraction routine (Figure 3-7) are included for references.

Tire Pressure Monitoring System User's Guide

FIGURE 3-5: 4 POINTS SENSOR CALIBRATION ROUTINE (INTERSEMA)

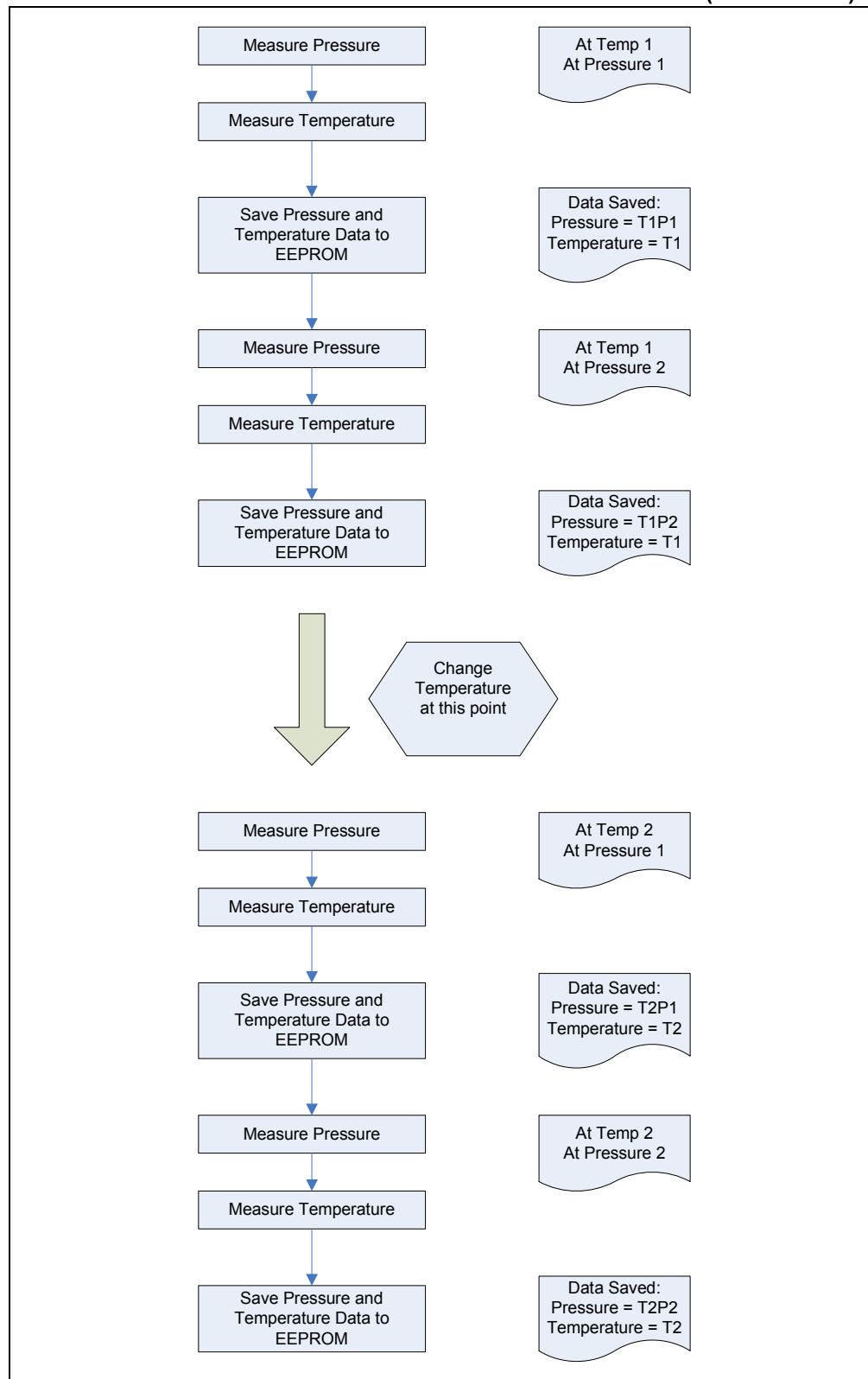
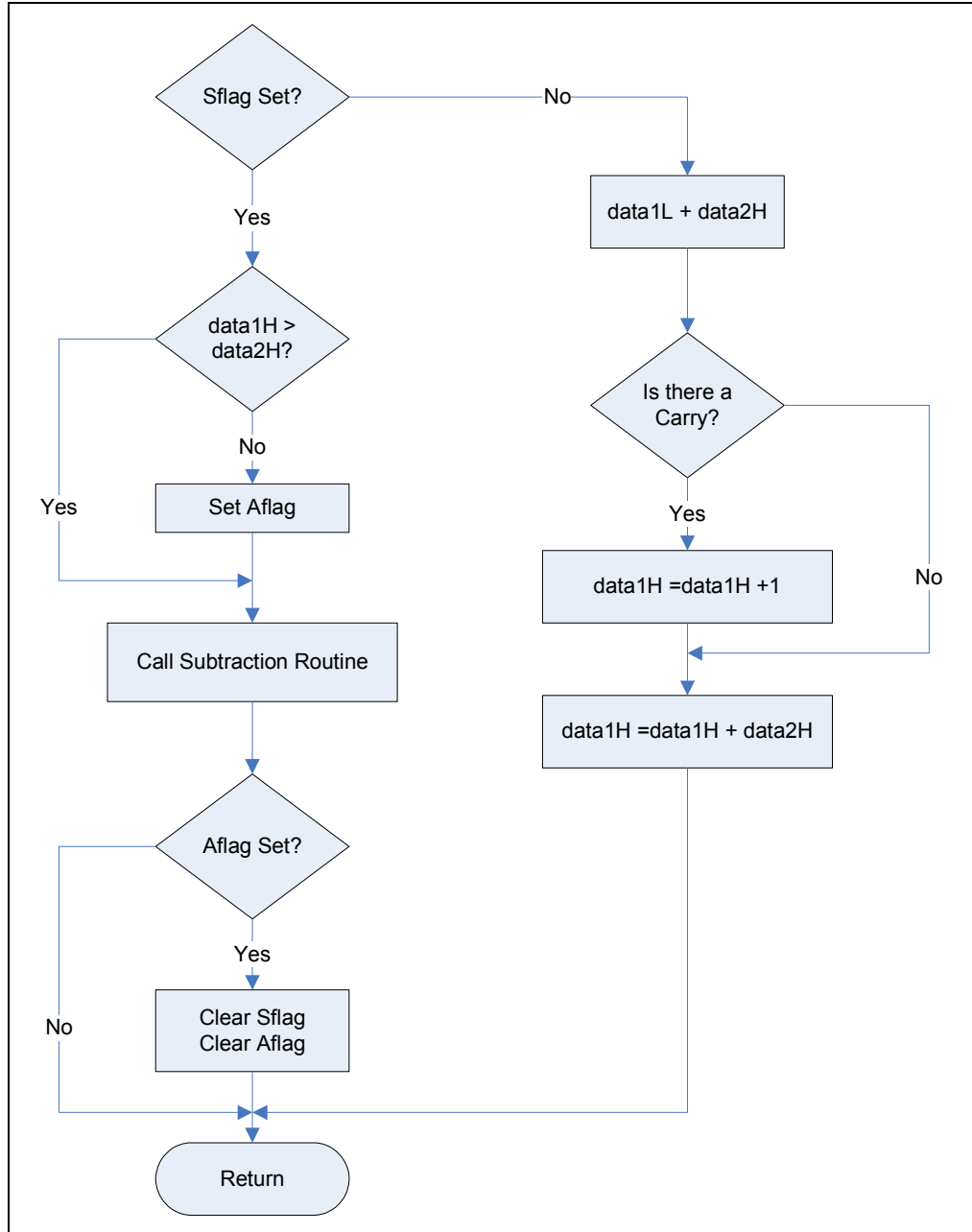
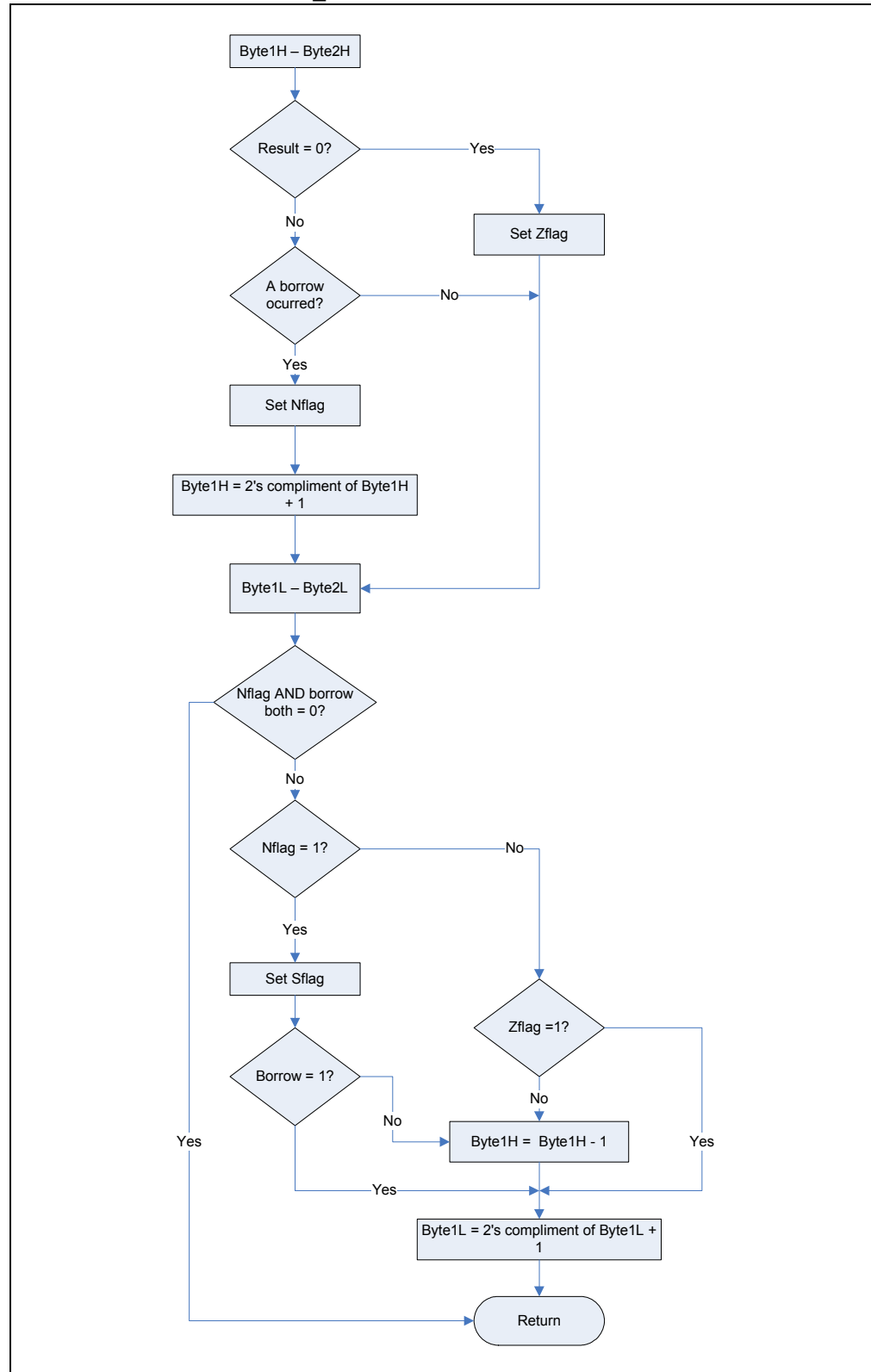

FIGURE 3-6: SENSOR_TX ADD FLOWCHART



Tire Pressure Monitoring System User's Guide

FIGURE 3-7: SENSOR_TX SUB FLOWCHART



3.6.1 Reference Documents

PROVIDE LATER



TIRE PRESSURE MONITORING SYSTEM USER'S GUIDE

Appendix A. Schematic and Layouts

A.1 INTRODUCTION

This appendix contains the schematic and PCB layout for the Tire Pressure Monitoring System. Diagrams included:

- Base Station Module Schematic (Page 1)
- Base Station Module Schematic (Page 2)
- Base Station Wiring Harness Schematic
- Base Station Module - Top Layer (with silk screen)
- Base Station Module - Bottom Layer
- Low Frequency Initiator Module Schematic
- Low Frequency Initiator Module - Top Layer (with silk screen)
- Low Frequency Initiator Module - Bottom Layer
- Transponder Sensor Module Schematic
- Transponder Sensor Module - Top Layer (with silk screen)
- Transponder Sensor Module - Bottom Layer

Tire Pressure Monitoring System User's Guide

A.2 BASE STATION MODULE SCHEMATIC (PAGE 1)

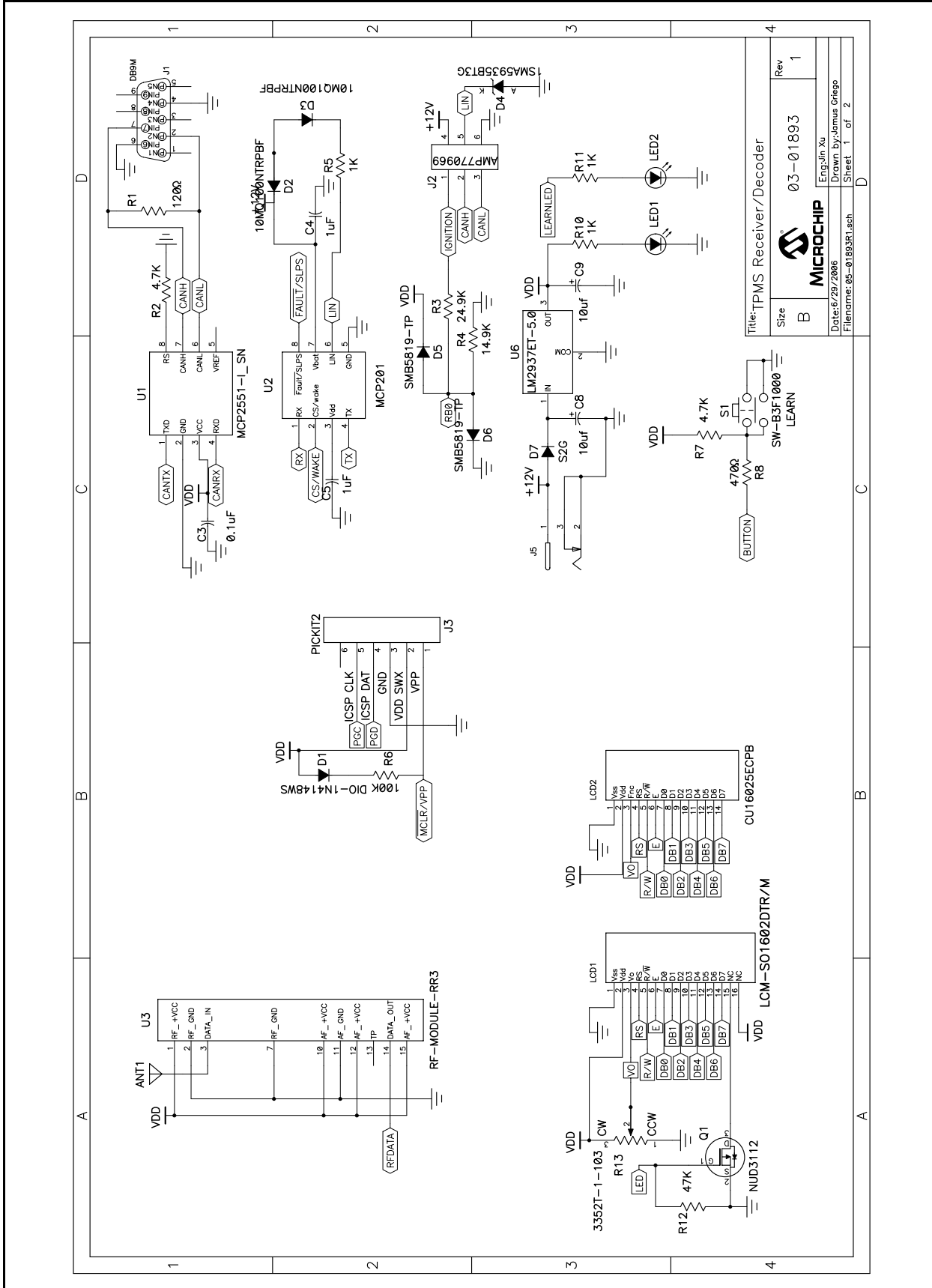

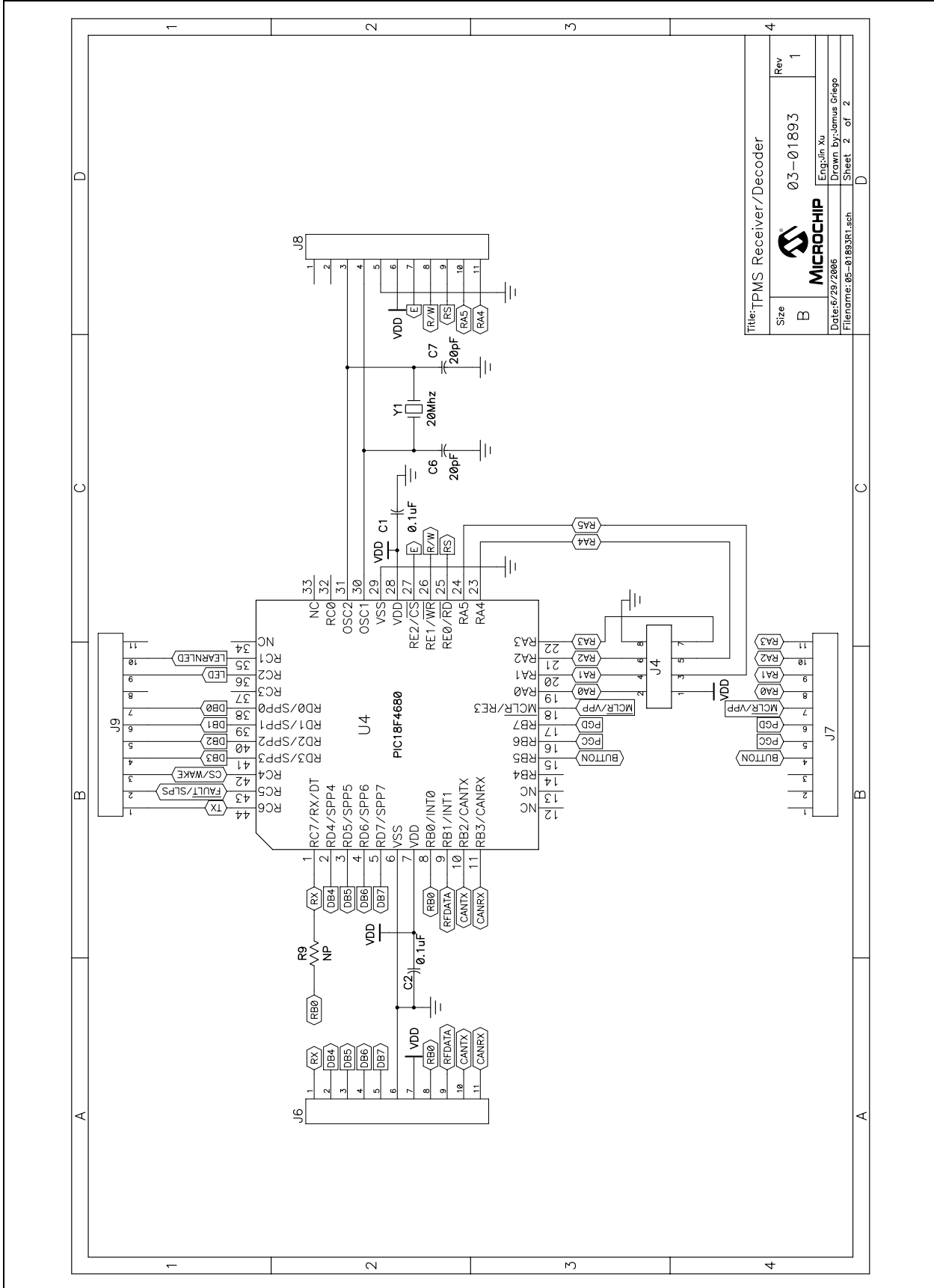

A.3 BASE STATION MODULE SCHEMATIC (PAGE 2)

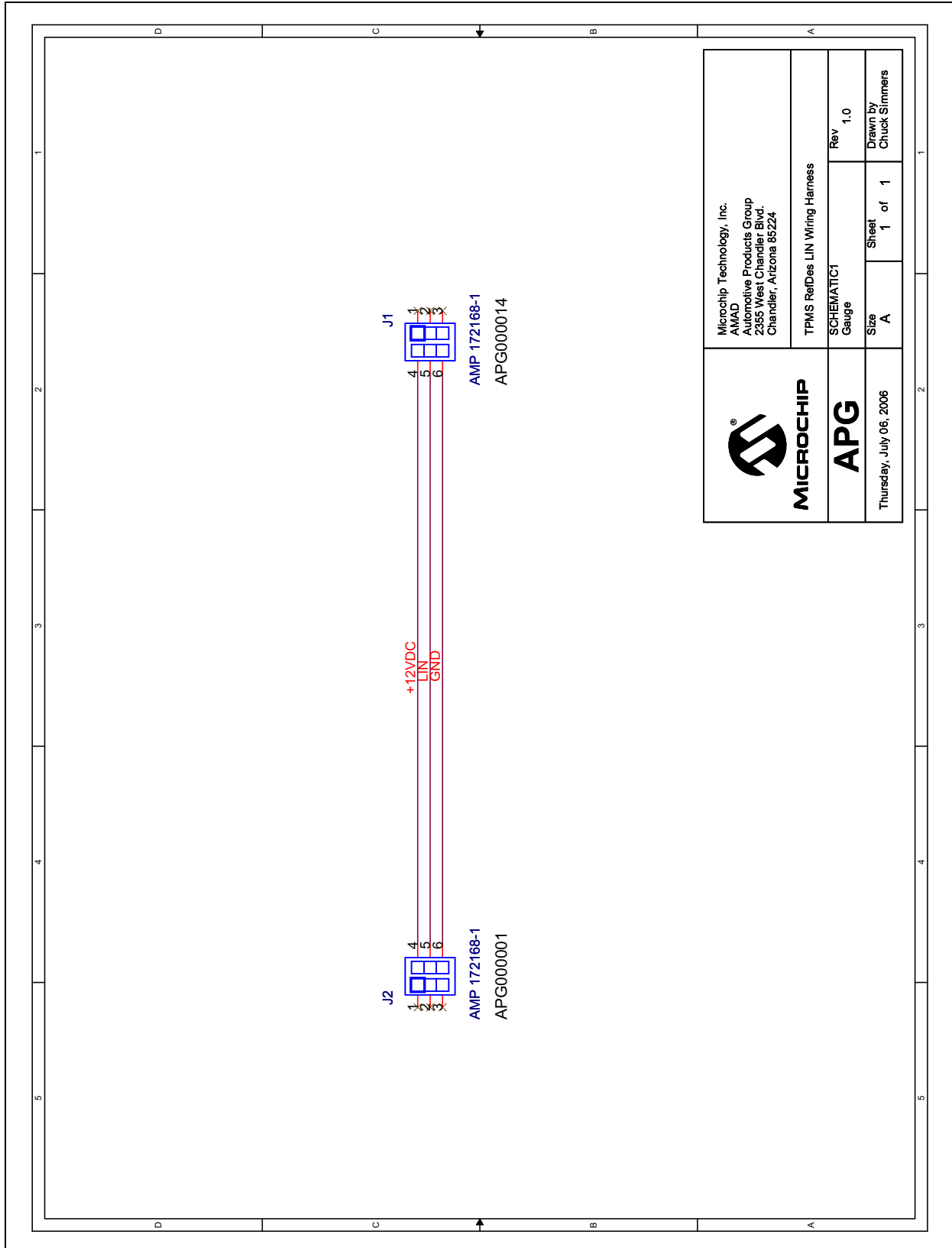

Tire Pressure Monitoring System User's Guide

A.4 BASE STATION WIRING HARNESS - SCHEMATIC



 MICROCHIP	Microchip Technology, Inc. AMAD Automotive Products Group 2355 West Chandler Blvd. Chandler, Arizona 85224
	TPMS RefDes LIN Wiring Harness Schematic1 Gauge
	Rev 1.0 Drawn by Chuck Simmers
APG Thursday, July 06, 2006	Sheet 1 of 1 Size A

A.5 BASE STATION MODULE - TOP LAYER AND SILK SCREEN

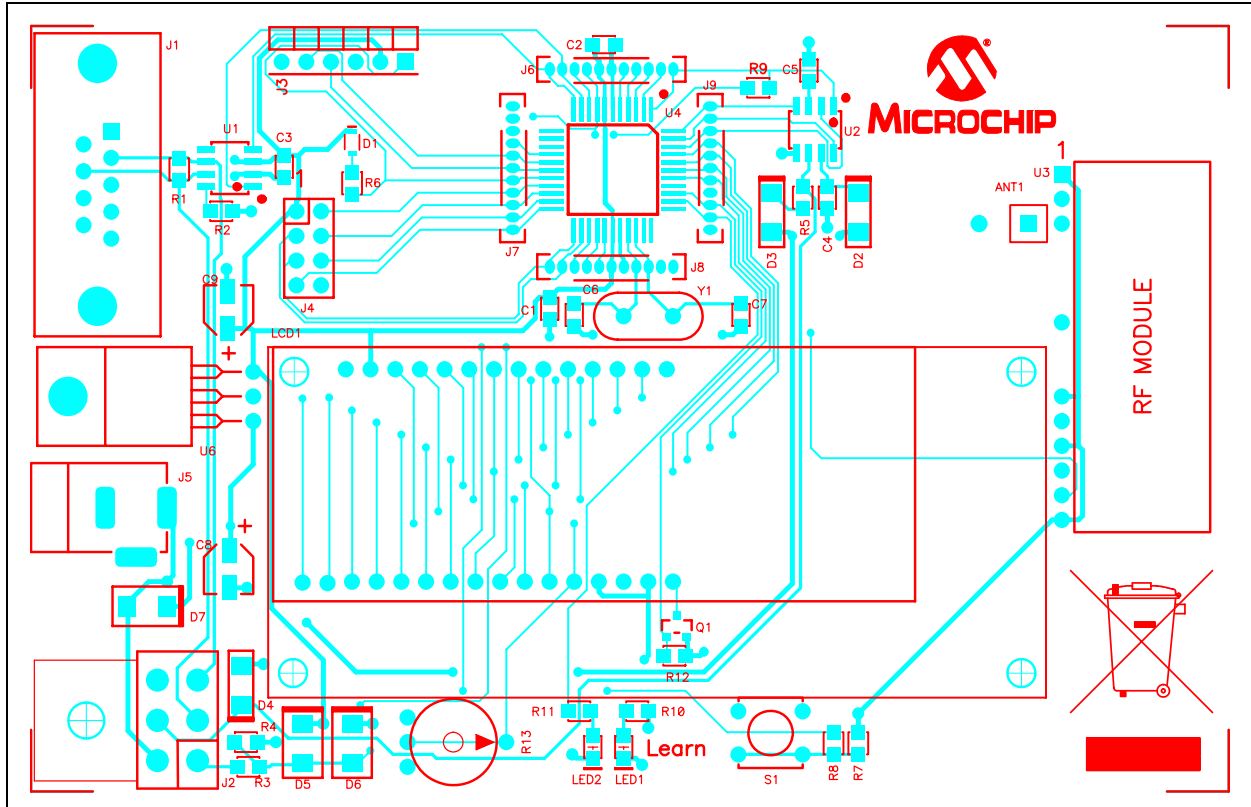

A.6 BASE STATION MODULE - BOTTOM LAYER

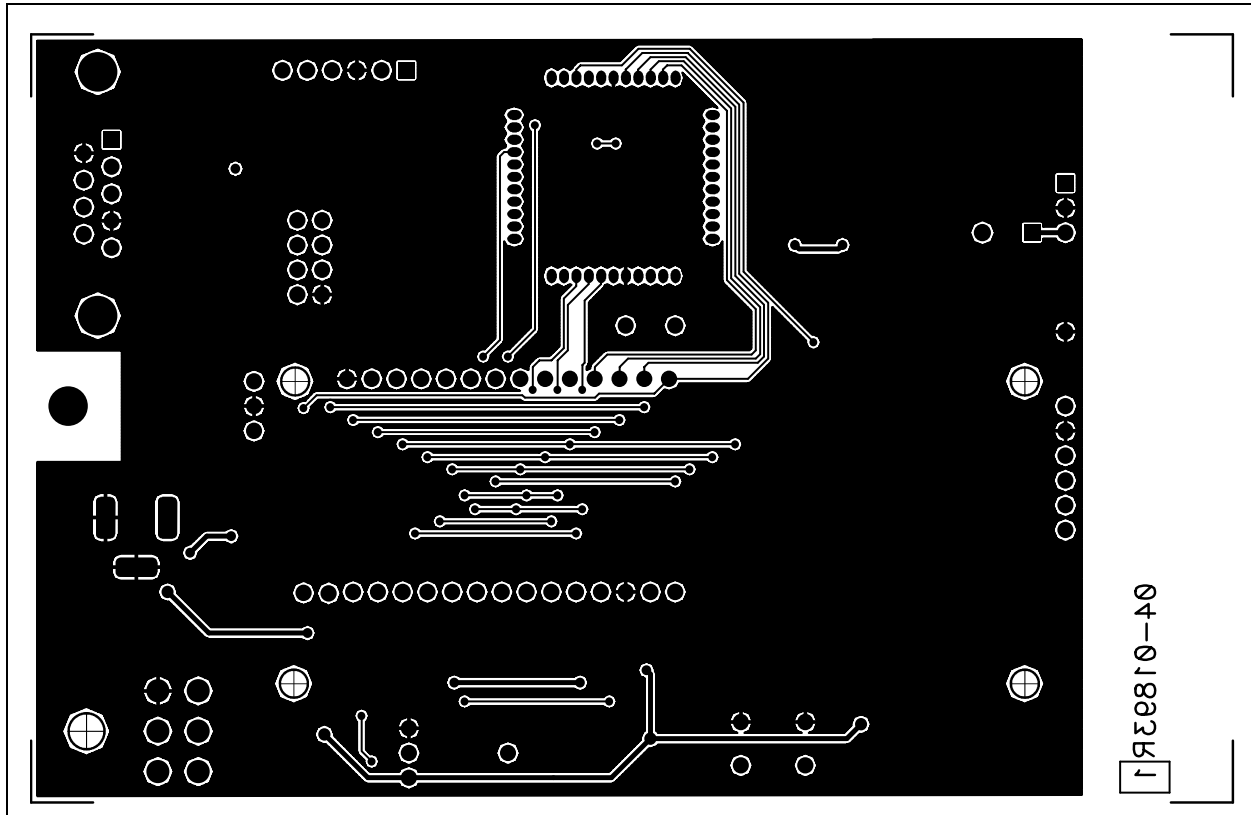

Tire Pressure Monitoring System User's Guide

A.7 LOW FREQUENCY INITIATOR MODULE - SCHEMATIC

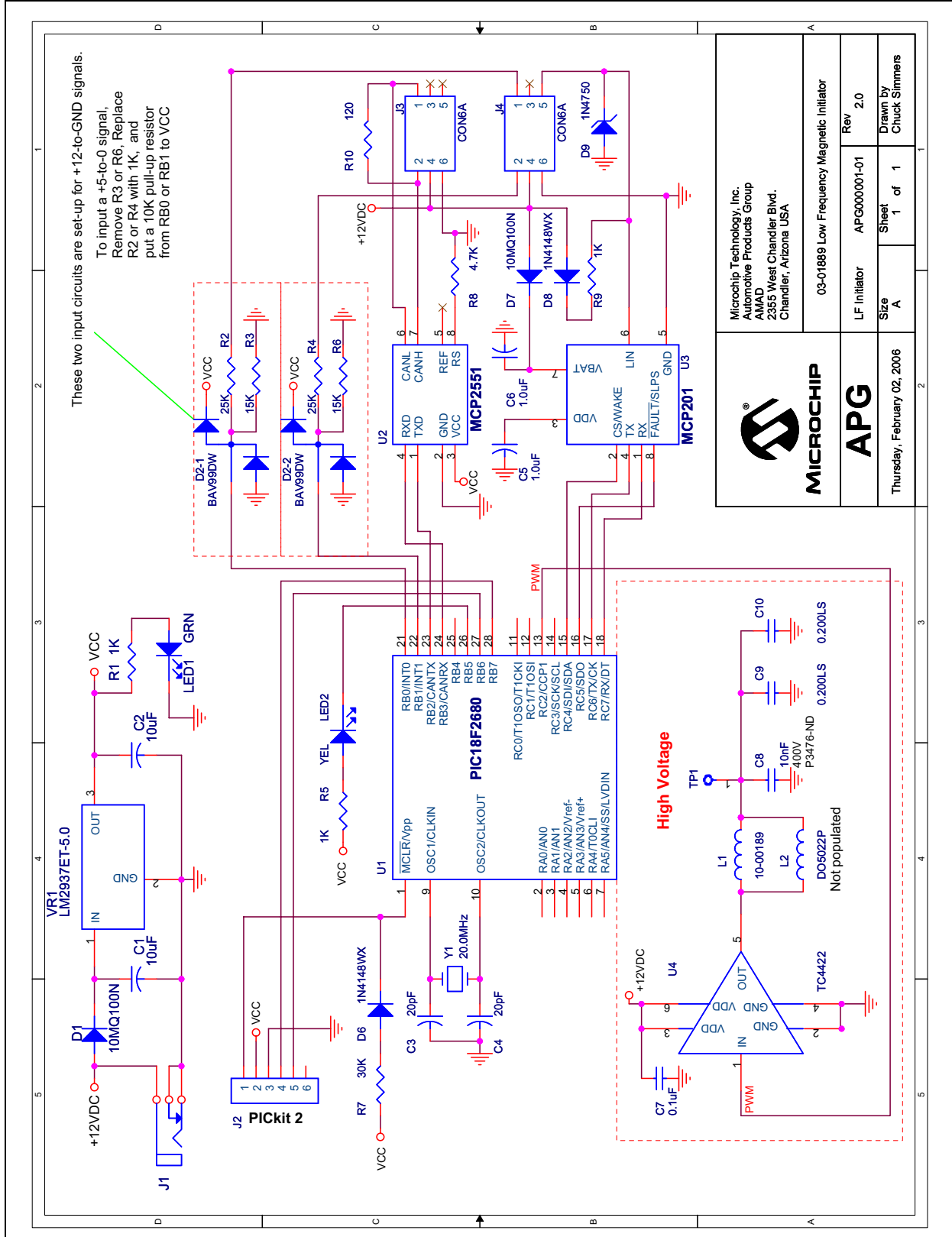

MICROCHIP
APG

Microchip Technology, Inc.
 Automotive Products Group
 AMAD
 2355 West Chandler Blvd.
 Chandler, Arizona USA

LF Initiator	APG000001-01	Rev	2.0
Sheet	1 of 1	Drawn by	Chuck Simmers
Size	A	Sheet	1 of 1
Thursday, February 02, 2006			

03-01889 Low Frequency Magnetic Initiator

A.8 LOW FREQUENCY INITIATOR MODULE - TOP LAYER AND SILK SCREEN

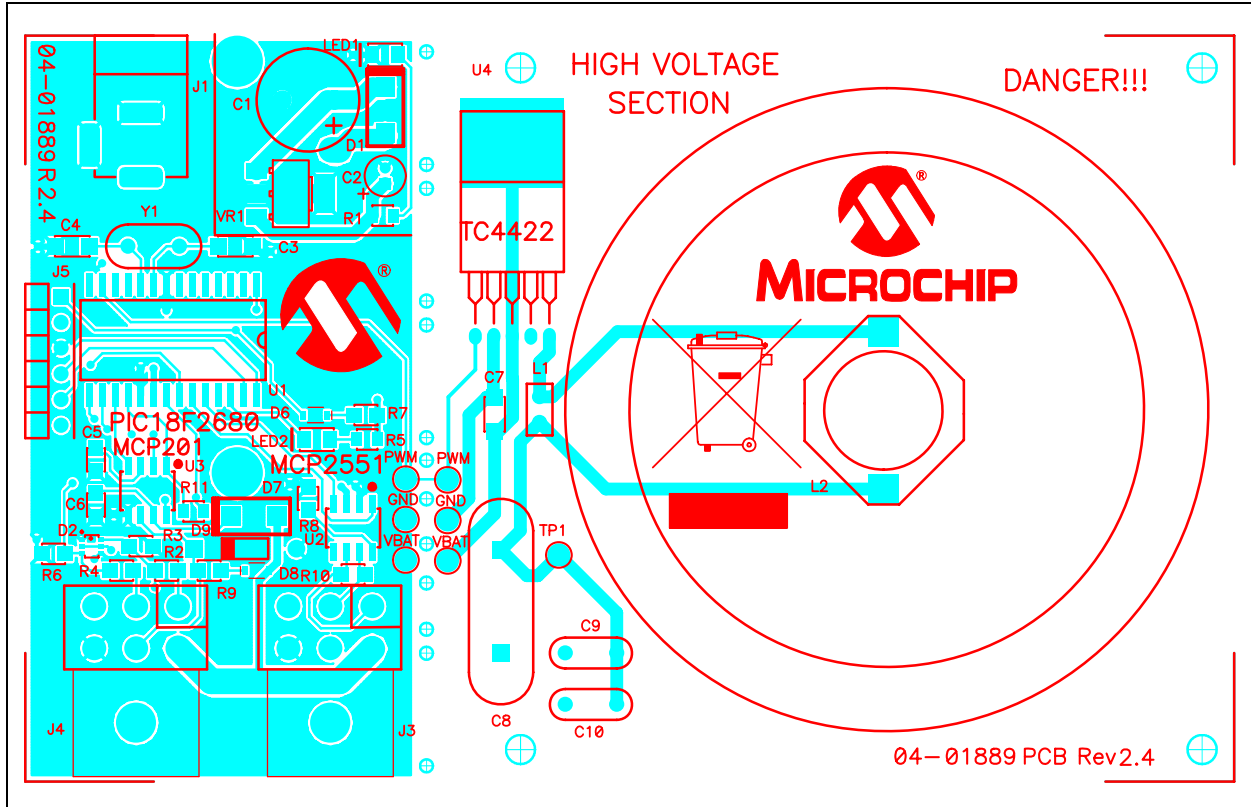

A.9 LOW FREQUENCY INITIATOR MODULE - BOTTOM LAYER

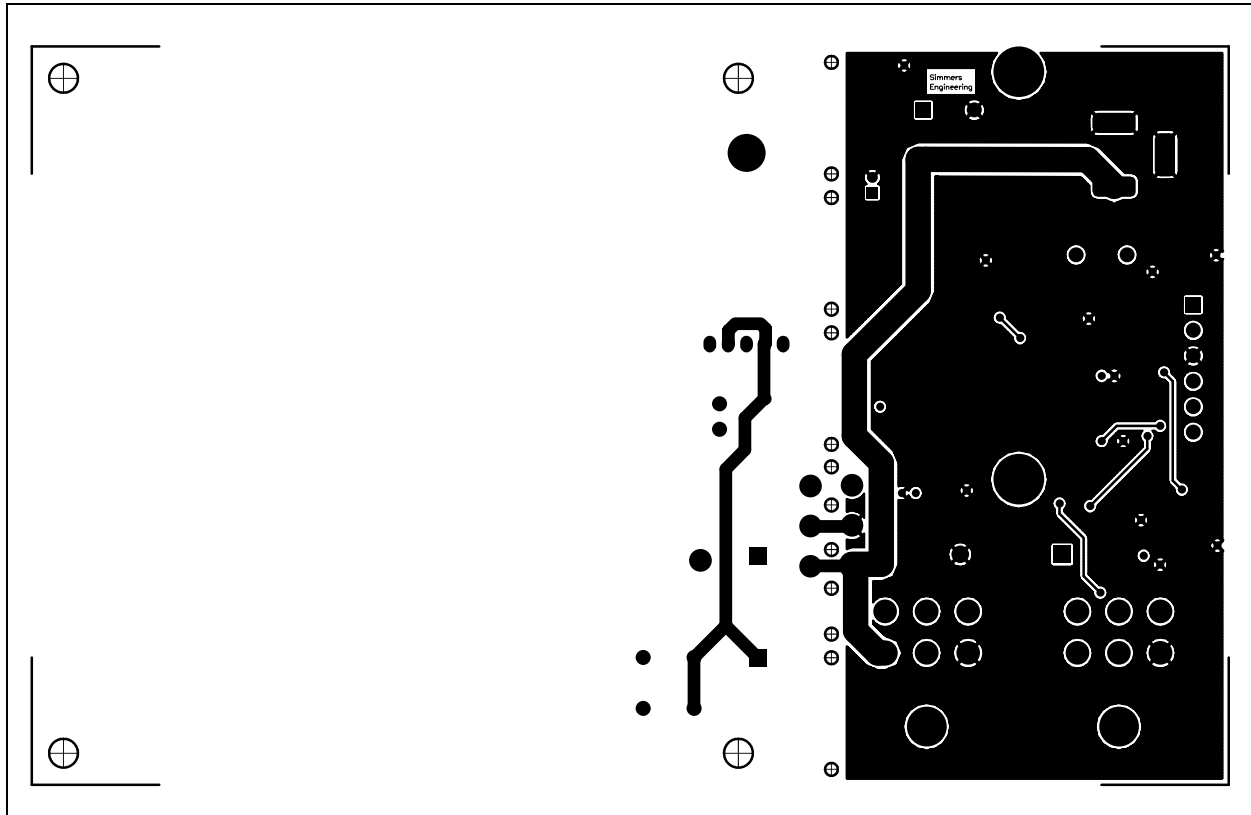

Tire Pressure Monitoring System User's Guide

A.10 TRANSPONDER SENSOR MODULE - SCHEMATIC

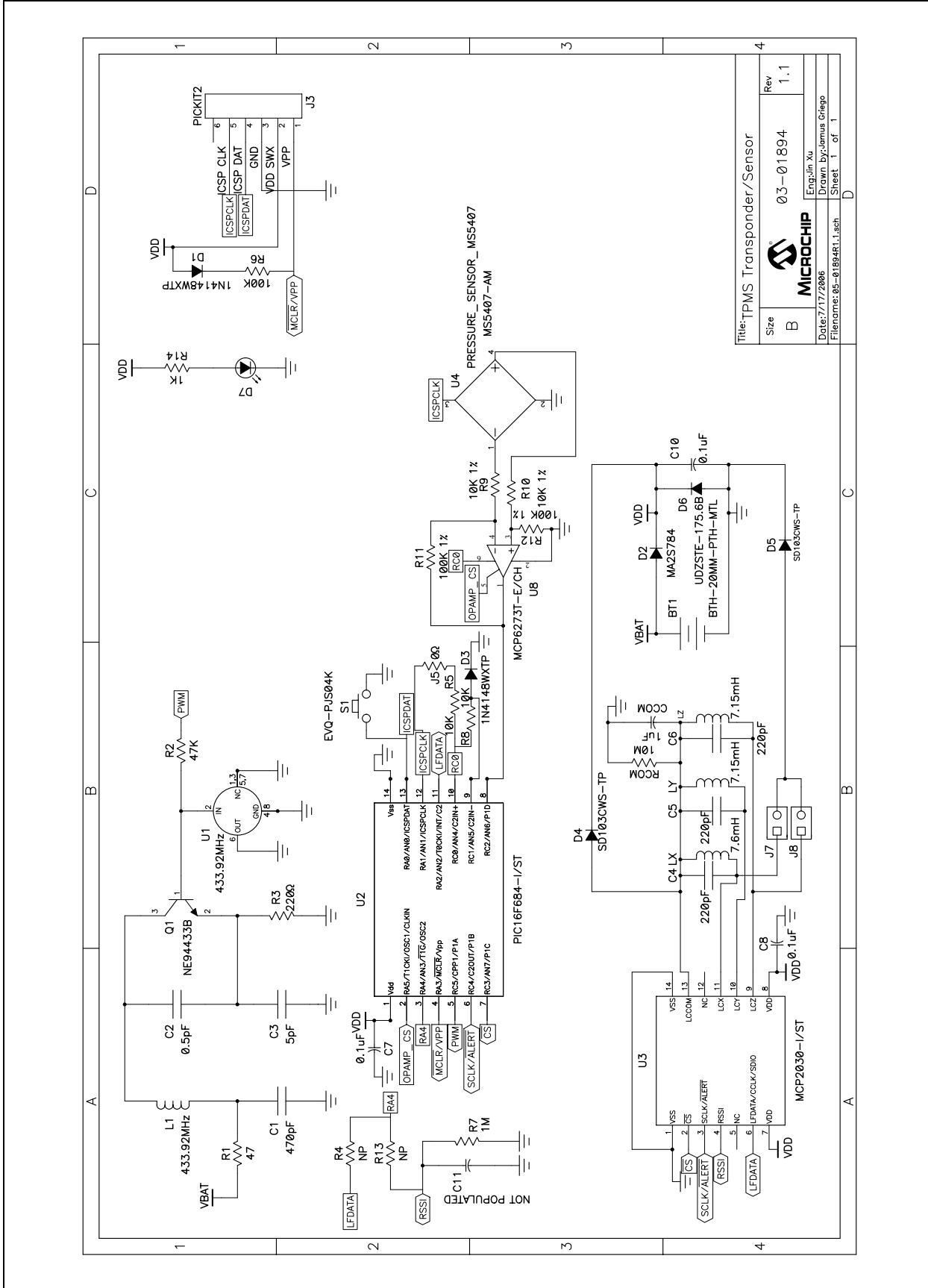

Title: TPMS Transponder/Sensor	
Size: B	Rev: 1.1
03-01894	
Eng: Jin Xu	
Drawn By: James Origo	
Sheet 1 of 1	
Filename: 95-01894R1.sch	

A.11 TRANSPONDER SENSOR MODULE - TOP LAYER AND SILK SCREEN

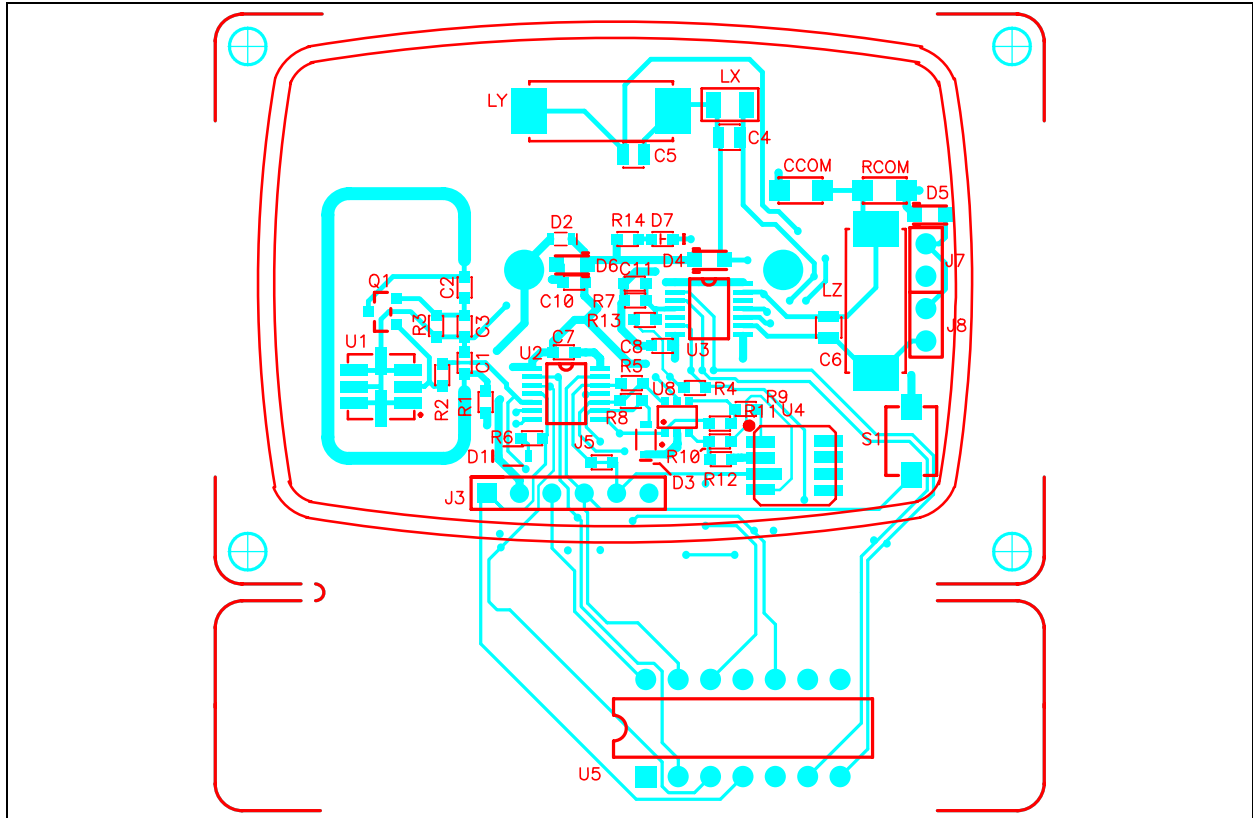

A.12 TRANSPONDER SENSOR MODULE - BOTTOM LAYER

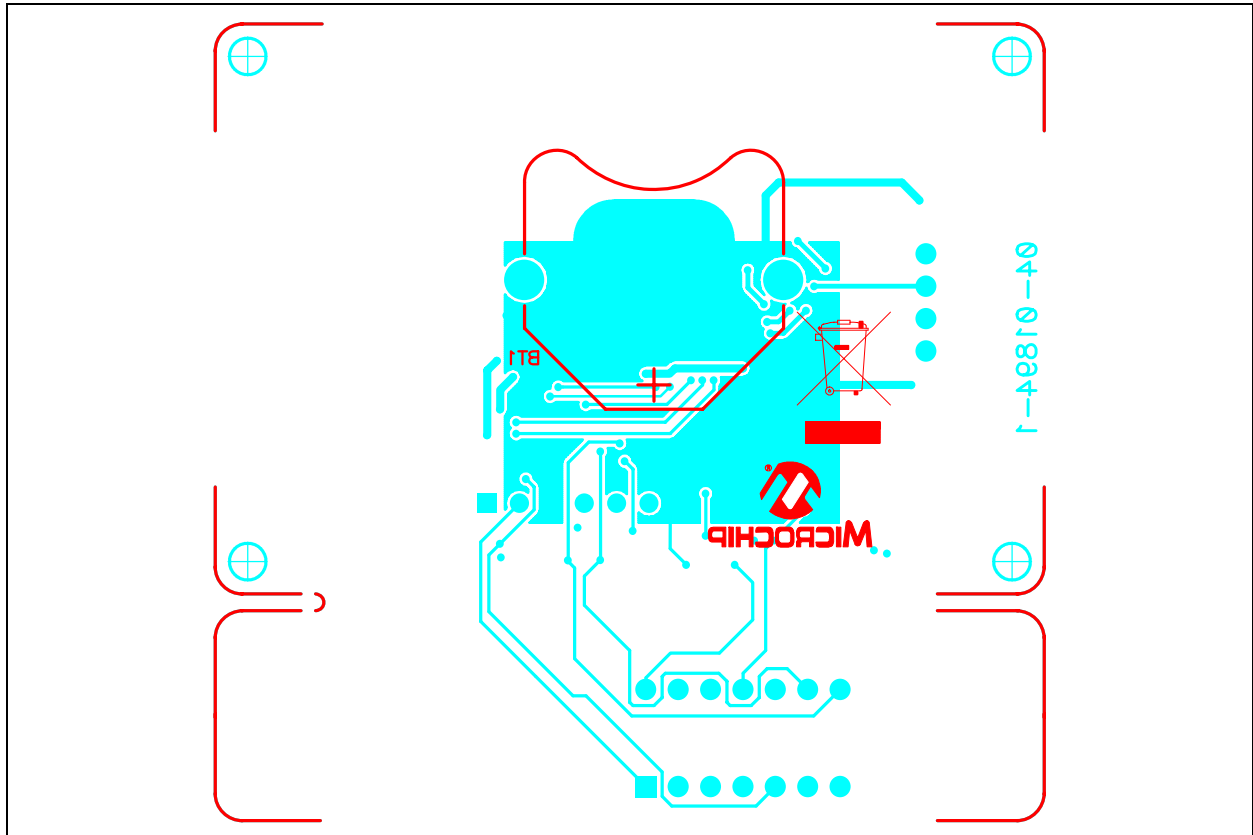

Tire Pressure Monitoring System User's Guide

A.13 CIRCUIT BLOCK FIGURE

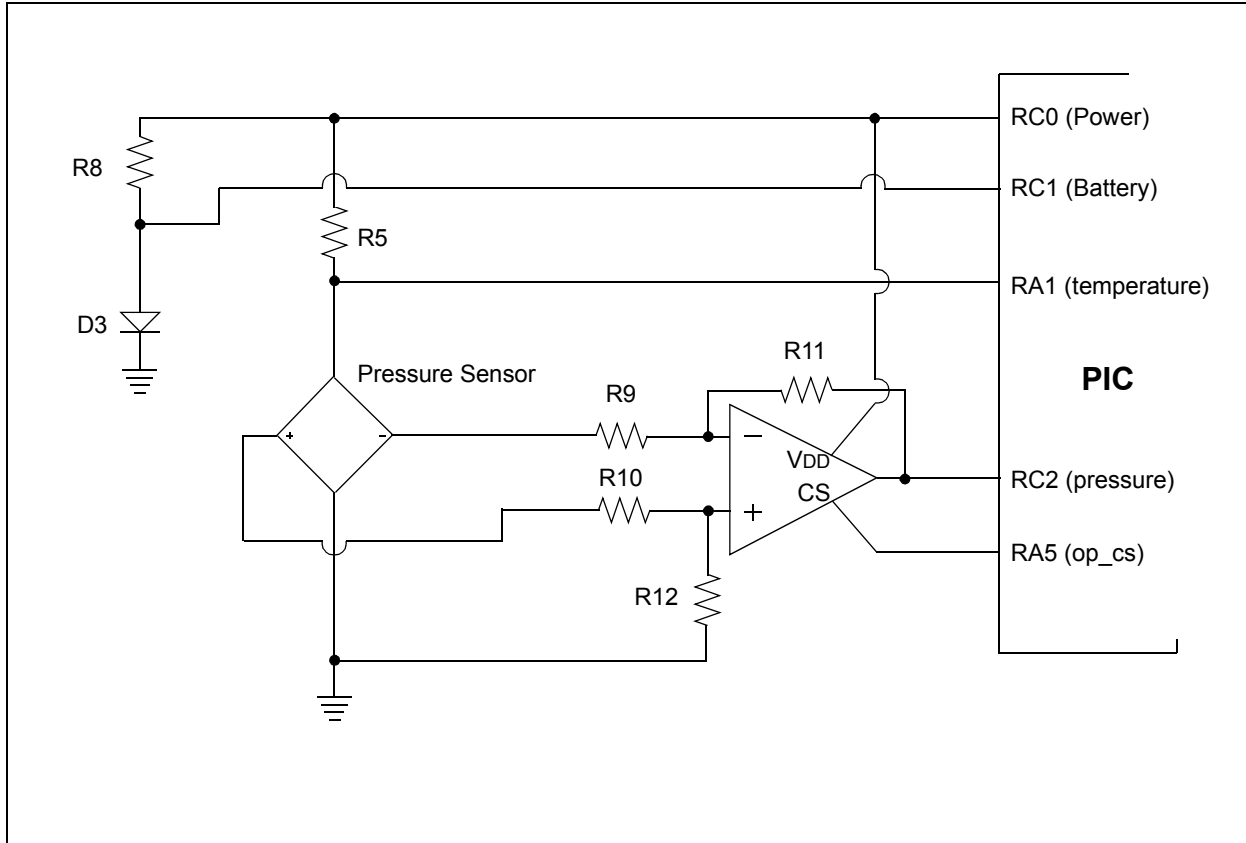



TIRE PRESSURE MONITORING SYSTEM USER'S GUIDE

Appendix B. Bill Of Materials (BOM)

TABLE B-1: BASE STATION MODULE BILL OF MATERIALS (BOM)

Qty	Reference	Description	Manufacturer	Part Number
1	J2	AMP770969		1-770969-0-ND
1	ANT1	ANT_WIRE		
3	C1,C2,C3	CAP0805	0.1uF	PCC1828CT-ND
2	C4,C5	CAP0805	1uF	PCC1849CT-ND
2	C6,C7	CAP0805	18pF	311-1102-1-ND
2	C8,C9	CAP_VS_B	10uf	493-2099-1-ND
1	J5	CONN_PJ-007		CP-102B-ND
1	Y1	CRY_CITIZEN_HCM49	20MHz	X1076-ND
0	J1	DB9M		DO NOT ASSEMBLE
1	D1	DIO-1N4148WS		1N4148WS-FDICT-ND
1	D7	DIODE-DO214	S2G	S2G-TPMSCT-ND
2	D5, D6	DIODE-DO214	SMB5819-TP	SK14-TPMSCT-ND
2	D2,D3	DIODE-SMA	10MQ100NTRPBF	10MQ100NPBFCT-ND
1	D4	DIODE_ZENER_SMA	1SMA5935BT3G	1SMA5935BT3GOSCT-ND
1	Q1	FET-BSS84-SOT23	NUD3112	NUD3112LT1G NUD3112LT1GOS-ND
1	J4	HDR2X4		HTSW-104-07-F-D
0	LCD2	LCD_CU16025ECPB	CU16025ECPB	DO NOT ASSEMBLE
1	LCD1	LCD_SO1602_16X2	LCM-SO1602DTR/M	67-1781-ND
1	xLCD1	16p Header		HTSW-116-07-F-S
2	LED1, LED2	LED_0805		160-1179-1-ND
1	U6	LM2940T	LM2937ET-5.0	LM2937ET-5.0-ND/NOPB
1	U2	MCP201		Microchip Supplied
1	U1	MCP2551-I_SN		Microchip Supplied
1	U4	PIC18F4680-44TQFP	PIC18F4680	Microchip Supplied
1	R13	POT-3352E	3352T-1-103	3352T-1-103LF-ND
1	R6	RES0603	100KΩ	311-100KARCT-ND
3	R5,R10,R11	RES0805	1KΩ	311-1.0KARCT-ND
2	R2,R7	RES0805	4.7KΩ	311-4.7KARCT-ND
1	R4	RES0805	14.9KΩ	311-15.0KCRCT-ND
1	R3	RES0805	24.9KΩ	28K1086
1	R12	RES0805	47KΩ	311-47KARCT-ND
1	R1	RES0805	120Ω	311-120ARCT-ND
1	R8	RES0805	470Ω	311-470ARCT-ND
0	R9	RES0806		DO NOT ASSEMBLE
1	U3	RF-MODULE-RR3		AMRRQ3-433
1	J3	SIP_6	PICKIT2	HTSW-106-07-G-S-RA

Note 1: The components listed in this Bill of Materials are representative of the PCB assembly. The released BOM used in manufacturing uses all RoHS-compliant components.

Tire Pressure Monitoring System User's Guide

TABLE B-1: BASE STATION MODULE BILL OF MATERIALS (BOM) (CONTINUED)

Qty	Reference	Description	Manufacturer	Part Number
4	J6,J7,J8,J9	SIP_11_05_PITCH		HMTMS-111-01-G-S-230
1	S1	SW-B3F1000		SW404-ND
1	Bag	10N298	Newark-In-One	Anti static bag
1	PCB	REV 1		
4	Feet		3M	SJ-67A11

Note 1: The components listed in this Bill of Materials are representative of the PCB assembly. The released BOM used in manufacturing uses all RoHS-compliant components.

TABLE B-2: BASE STATION WIRING HARNESS BILL OF MATERIALS (BOM)

Qty	Reference	Description	Manufacturer	Part Number
2	J1,J2	AMP 172168-1		A25573-ND
6		AMP 171639-1		
1		18-gauge RED stranded wire 6" in Length		
1		18-gauge BLK stranded wire 6" in Length		
1		18-gauge BLU stranded wire 6" in Length		

Note 1: The components listed in this Bill of Materials are representative of the PCB assembly. The released BOM used in manufacturing uses all RoHS-compliant components.

TABLE B-3: LOW FREQUENCY INITIATOR MODULE BILL OF MATERIALS

Qty	Reference	Description	Manufacturer	Part Number
1	C1	100uF		P10323-ND
1	C2	10uF		P966-ND
2	C3,C4	20pF		311-1153-1-ND
2	C5,C6	1.0uF		495-1935-1-ND
1	C7	0.1uF		311-1179-1-ND
1	C8	10nF		495-1225-ND
2	C9,C10	.200LS		not assembled
2	D1,D7	10MQ100N		10MQ100NPBFCT-ND
1	D2	BAV99DW		BAV99DW-FDICT-ND
1	D6,D8	1N4148WX-TP		1N4148WXTPMSCT-ND
1	D9	1N4750 27V		1N4750ADICT-ND
1	J1	POWERPLUG		CP-102B-ND
1	J5	6pinCON Rt Angle		TSW-106-08-G-S-RA
2	J3,J4	CON6AP		1-770969-0-ND
1	LED1	Green LED		160-1179-1-ND
1	LED2	Yellow LED		160-1175-1-ND
1	L1 Primary	MCD-L160UH		MCD-L160UH
0	L1	10-00189		Ask for Lead Free
1	L2	DO5022P		not assembled
1	R11			not assembled
3	R1, R5, R9	1K		28K0916
2	R2,R4	25K		28K1086
2	R3,R6	15K		28K0996

Note 1: The components listed in this Bill of Materials are representative of the PCB assembly. The released BOM used in manufacturing uses all RoHS-compliant components.

Bill Of Materials (BOM)

TABLE B-3: LOW FREQUENCY INITIATOR MODULE BILL OF MATERIALS (CONTINUED)

Qty	Reference	Description	Manufacturer	Part Number
1	R7	30K		28K1124
1	R8	4.7K		28K1196
1	R10	120		28K0956
1	TP1	TEST POINT		not assembled
1	U1	PIC18F2680		
1	U2	MCP2551		
1	U3	MCP201		
1	U4	TC4422		
1	VR1	LM2937IMP-5.0		LM2937IMP-5.0CT-ND
1	Y1	20.0MHz		X1076-ND
1	Bag	10N298		Newark-In-One
1	PCB	REV 2.4		
1	HV Shield	Drawing Supplied		
4	Feet			Bumpon™

Note 1: The components listed in this Bill of Materials are representative of the PCB assembly. The released BOM used in manufacturing uses all RoHS-compliant components.

TABLE B-4: TRANSPONDER SENSOR MODULE BILL OF MATERIALS (BOM)

Qty	Reference	Description	Manufacturer	Part Number
2	J7, J8	2phdr	SAMTEC	TSW-102-08-G-S
1	BT1	3003	Keystone	3003K-ND
1	xBT1	CR2032	Energizer	N189-ND
3	C7, C8, C10	0.1uF	Panasonic	PCC1762CT-ND
1	CCOM	1uF	Murata	490-1807-1-ND
2	C4, C5, C6	220pF	RHOM	511-1146-1-ND
1	C2	0.5pF	RHOM	511-1086-1-ND
1	C3	5pF	RHOM	511-1103-1-ND
1	C1	470pF	RHOM	511-1154-1-ND
2	D1, D3	1N4148WXTTP	Micro Comercial Co	1N4148WXTTPMSCT-ND
1	D2	MA2S784	Panasonic	MA2S78400LCT-ND
2	D4, D5	SD103CWS-TP	Micro Comercial Co	SD103CWSTPMSCT-ND
1	D6	UDZSTE-175.6B	RHOM	UDZSTE-175.6BCT-ND
2	LY, LZ	7.15mH	Coilcraft	5315TC-715XGLB
1	D7	Grn LED	Lite-ON	160-1183-1-ND
1	LX	7.6mH	Mc Davis	Custom Inductor
1	U3	MCP2030-I/ST	Microchip supplied	Microchip supplied
1	U8	MCP6273T-E/CH	Microchip supplied	Microchip supplied
1	U2	PIC16F684-I/ST	Microchip supplied	Microchip supplied
1	U5	Dip Socket	Assman	AR14-HZL-TT-R
1	U4	MS5407-AM	NTERSEMA	
1	S1	EVQ-PJS04K	Panasonic	8048SCT-ND
2	J5, C11	NOT POPULATED	NOT POPULATED	NOT POPULATED
2	R4, R13	NOT POPULATED	NOT POPULATED	NOT POPULATED

Note 1: The components listed in this Bill of Materials are representative of the PCB assembly. The released BOM used in manufacturing uses all RoHS-compliant components.

Tire Pressure Monitoring System User's Guide

TABLE B-4: TRANSPONDER SENSOR MODULE BILL OF MATERIALS (BOM) (CONTINUED)

Qty	Reference	Description	Manufacturer	Part Number
1	R14	1K	RHOM	RHM1.0KGCT-ND
1	R7	1M	RHOM	RHM1.0MGCT-ND
4	R5, R8, R9, R10	10K	RHOM	RHM10.0KHCT-ND
3	R6, R11, R12	100K	RHOM	RHM100KHCT-ND
1	RCOM	10M	YAGEO	311-10MERCT-ND
1	R1	47	YAGEO	311-47.0HRCT-ND
1	R2	47K	YAGEO	311-47.0KHRCT-ND
1	R3	220	YAGEO	311-220HRCT-ND
1	U1	433.92MHz	YAGEO	XC998CT-ND
1	J3	PICKIT2	SAMTEC	TSW-106-08-G-S
1	Q1	NE94433B	NEC	NE94433B-ACT-ND
1	Metal Out bag		SPC	10N298
1	PCB			

Note 1: The components listed in this Bill of Materials are representative of the PCB assembly. The released BOM used in manufacturing uses all RoHS-compliant components.

Bill Of Materials (BOM)

NOTES:



WORLDWIDE SALES AND SERVICE

AMERICAS

Corporate Office

2355 West Chandler Blvd.
Chandler, AZ 85224-6199
Tel: 480-792-7200
Fax: 480-792-7277
Technical Support:
<http://support.microchip.com>
Web Address:
www.microchip.com

Atlanta

Alpharetta, GA
Tel: 770-640-0034
Fax: 770-640-0307

Boston

Westborough, MA
Tel: 774-760-0087
Fax: 774-760-0088

Chicago

Itasca, IL
Tel: 630-285-0071
Fax: 630-285-0075

Dallas

Addison, TX
Tel: 972-818-7423
Fax: 972-818-2924

Detroit

Farmington Hills, MI
Tel: 248-538-2250
Fax: 248-538-2260

Kokomo

Kokomo, IN
Tel: 765-864-8360
Fax: 765-864-8387

Los Angeles

Mission Viejo, CA
Tel: 949-462-9523
Fax: 949-462-9608

Santa Clara

Santa Clara, CA
Tel: 408-961-6444
Fax: 408-961-6445

Toronto

Mississauga, Ontario,
Canada
Tel: 905-673-0699
Fax: 905-673-6509

ASIA/PACIFIC

Asia Pacific Office

Suites 3707-14, 37th Floor
Tower 6, The Gateway
Harbour City, Kowloon
Hong Kong
Tel: 852-2401-1200
Fax: 852-2401-3431

Australia - Sydney

Tel: 61-2-9868-6733
Fax: 61-2-9868-6755

China - Beijing

Tel: 86-10-8528-2100
Fax: 86-10-8528-2104

China - Chengdu

Tel: 86-28-8665-5511
Fax: 86-28-8665-7889

China - Fuzhou

Tel: 86-591-8750-3506
Fax: 86-591-8750-3521

China - Hong Kong SAR

Tel: 852-2401-1200
Fax: 852-2401-3431

China - Qingdao

Tel: 86-532-8502-7355
Fax: 86-532-8502-7205

China - Shanghai

Tel: 86-21-5407-5533
Fax: 86-21-5407-5066

China - Shenyang

Tel: 86-24-2334-2829
Fax: 86-24-2334-2393

China - Shenzhen

Tel: 86-755-8203-2660
Fax: 86-755-8203-1760

China - Shunde

Tel: 86-757-2839-5507
Fax: 86-757-2839-5571

China - Wuhan

Tel: 86-27-5980-5300
Fax: 86-27-5980-5118

China - Xian

Tel: 86-29-8833-7250
Fax: 86-29-8833-7256

ASIA/PACIFIC

India - Bangalore

Tel: 91-80-4182-8400
Fax: 91-80-4182-8422

India - New Delhi

Tel: 91-11-4160-8631
Fax: 91-11-4160-8632

India - Pune

Tel: 91-20-2566-1512
Fax: 91-20-2566-1513

Japan - Yokohama

Tel: 81-45-471- 6166
Fax: 81-45-471-6122

Korea - Gumi

Tel: 82-54-473-4301
Fax: 82-54-473-4302

Korea - Seoul

Tel: 82-2-554-7200
Fax: 82-2-558-5932 or
82-2-558-5934

Malaysia - Penang

Tel: 60-4-646-8870
Fax: 60-4-646-5086

Philippines - Manila

Tel: 63-2-634-9065
Fax: 63-2-634-9069

Singapore

Tel: 65-6334-8870
Fax: 65-6334-8850

Taiwan - Hsin Chu

Tel: 886-3-572-9526
Fax: 886-3-572-6459

Taiwan - Kaohsiung

Tel: 886-7-536-4818
Fax: 886-7-536-4803

Taiwan - Taipei

Tel: 886-2-2500-6610
Fax: 886-2-2508-0102

Thailand - Bangkok

Tel: 66-2-694-1351
Fax: 66-2-694-1350

EUROPE

Austria - Wels

Tel: 43-7242-2244-3910
Fax: 43-7242-2244-393

Denmark - Copenhagen

Tel: 45-4450-2828
Fax: 45-4485-2829

France - Paris

Tel: 33-1-69-53-63-20
Fax: 33-1-69-30-90-79

Germany - Munich

Tel: 49-89-627-144-0
Fax: 49-89-627-144-44

Italy - Milan

Tel: 39-0331-742611
Fax: 39-0331-466781

Netherlands - Drunen

Tel: 31-416-690399
Fax: 31-416-690340

Spain - Madrid

Tel: 34-91-708-08-90
Fax: 34-91-708-08-91

UK - Wokingham

Tel: 44-118-921-5869
Fax: 44-118-921-5820