

NUF4107FC

Four Channel EMI Pi-Filter Array with Full USB Filter

This device is a four-channel EMI filter array for data lines. Greater than -35 dB attenuation is obtained at frequencies from 800 MHz to 2.2 GHz. It also offers USB filtering circuitry with speed detection. This includes the inline resistors for impedance matching and EMI filtering. ESD protection is provided across all capacitors.

Features

- EMI Filtering and ESD Protection for Data Lines
- USB 1.1 Filtering Provided with Speed Detection
- Integration of 27 Discretes Offers Cost and Space Savings
- 350 μm Solder Spheres
- All TVS Protected Inputs Comply with IEC61000-4-2 (Level 4)
 - 30 kV (Contact)
 - 30 kV (Air)
- Low Profile Flip-Chip Packaging
- MSL 1
- All Pins Exceed 2000 V Human Body Model (Note 1)
- Pb-Free Package is Available*

Typical Applications

- EMI and USB Filtering and ESD Protection for Data Lines
- Cell Phones
- Handheld Portables
- Notebook Computers
- MP3 Players

MAXIMUM RATINGS ($T_A = 25^\circ\text{C}$)

Rating	Symbol	Value	Unit
ESD Discharge IEC61000-4-2 (Note 1) – Air Discharge, Contact Discharge	V_{PP}	30	kV
Human Body Model		16	
Machine Model		0.4	
DC Power per Resistor	P_R	100	mW
DC Power per Package	P_T	600	mW
Junction Temperature	T_J	150	$^\circ\text{C}$
Operating Temperature Range	T_{op}	-40 to +85	$^\circ\text{C}$
Storage Temperature Range	T_{stg}	-55 to +150	$^\circ\text{C}$

Stresses exceeding Maximum Ratings may damage the device. Maximum Ratings are stress ratings only. Functional operation above the Recommended Operating Conditions is not implied. Extended exposure to stresses above the Recommended Operating Conditions may affect device reliability.

1. This does not include Pins B1, C1 and C2

*For additional information on our Pb-Free strategy and soldering details, please download the ON Semiconductor Soldering and Mounting Techniques Reference Manual, SOLDERRM/D.



ON Semiconductor®

<http://onsemi.com>

CIRCUIT DESCRIPTION

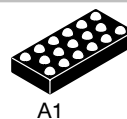
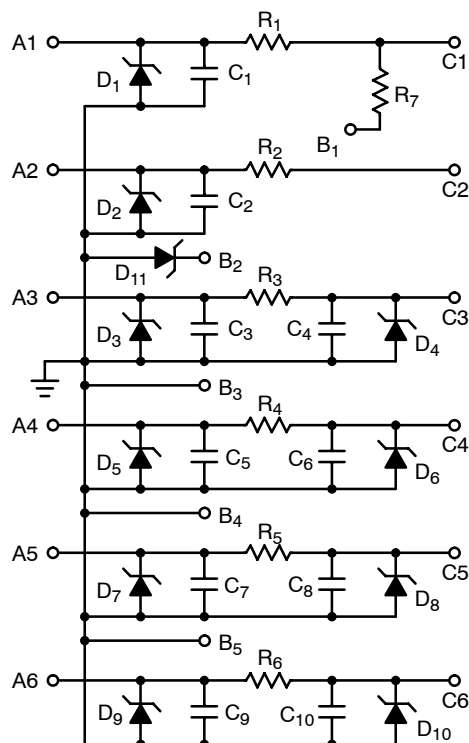

FLIP-CHIP-17
CASE 499AD

A1

MARKING DIAGRAM

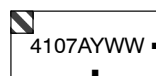

4107 = Device Code
A = Assembly Location
Y = Year
WW = Work Week
▪ = Pb-Free Package

(Note: Microdot may be in either location)

ORDERING INFORMATION

Device	Package	Shipping†
NUF4107FCT1	Flip-Chip	3000 Tape & Reel
NUF4107FCT1G	Flip-Chip (Pb-Free)	3000 Tape & Reel

†For information on tape and reel specifications, including part orientation and tape sizes, please refer to our Tape and Reel Packaging Specifications Brochure, BRD8011/D.

NUF4107FC

ELECTRICAL CHARACTERISTICS ($T_A = 25^\circ\text{C}$ unless otherwise noted)

Symbol	Characteristic	Min	Typ	Max	Unit
V_{BR}	$I_R = 1.0 \text{ mA}$	6.0	6.8	8.0	V
I_R	$V_{RM} = 3.3 \text{ V per line}$	-	-	0.1	μA
$R_3 - R_6$	EMI Filter Resistors	80	100	120	Ω
R_1, R_2	USB Resistors; Impedance Matching	18	22	26	Ω
R_7	USB Pull-up; Speed Detection Resistor	1250	1500	1750	Ω
C_{line}	At 2.5 V Bias	48	60	72	pF
C1, C2	At Pins A1 and A2; At 2.5 V Bias	29	36	43	pF
C_{power}	At Pins B2; At 2.5 V Bias	54	68	82	pF

NUF4107FC

TYPICAL CHARACTERISTICS

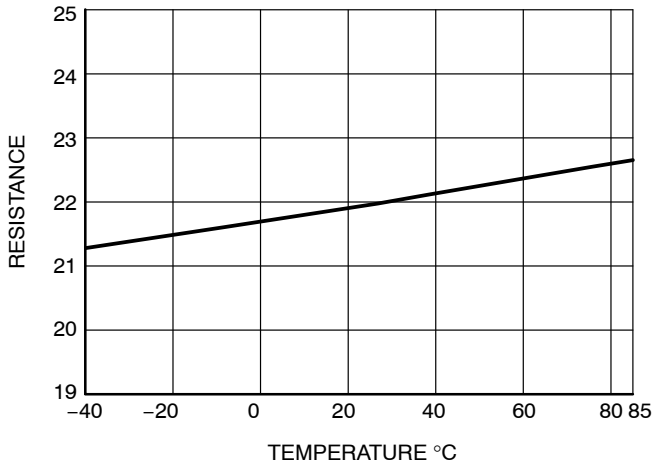

Figure 1. USB 1.1 Resistors (R1, R2) vs. Temperature

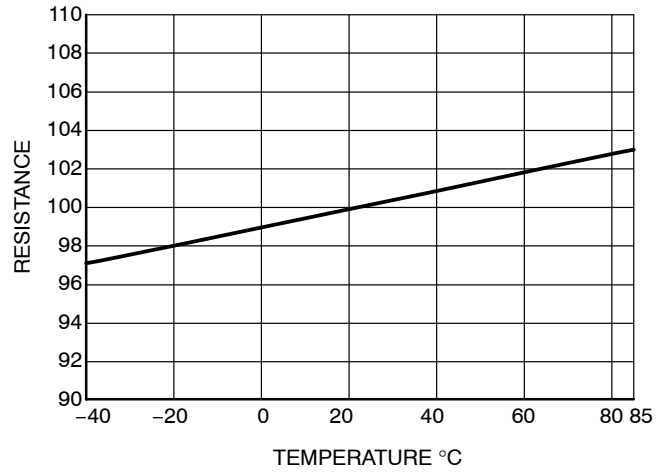

Figure 2. Data Resistors (R3, R4, R5, R6) vs. Temperature

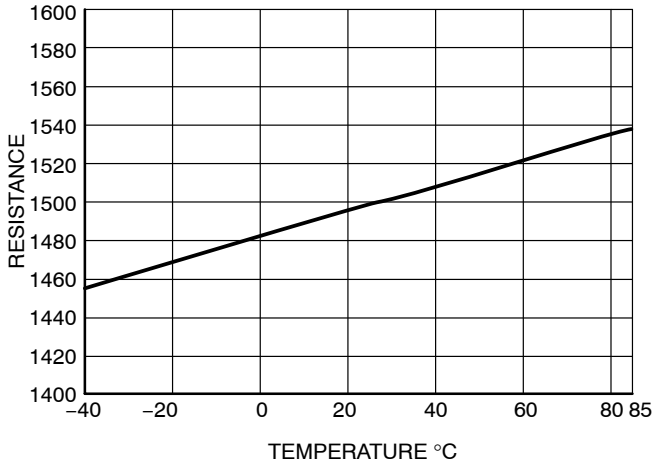

Figure 3. Pull-up Resistor (R7) vs. Temperature

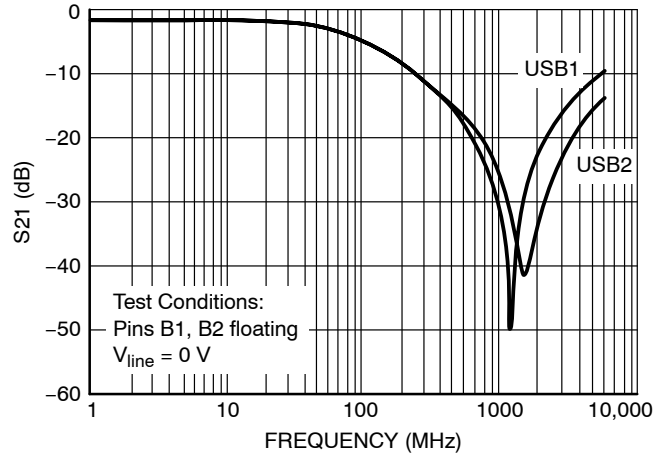

Figure 4. Insertion Loss Characteristic USB1, USB2

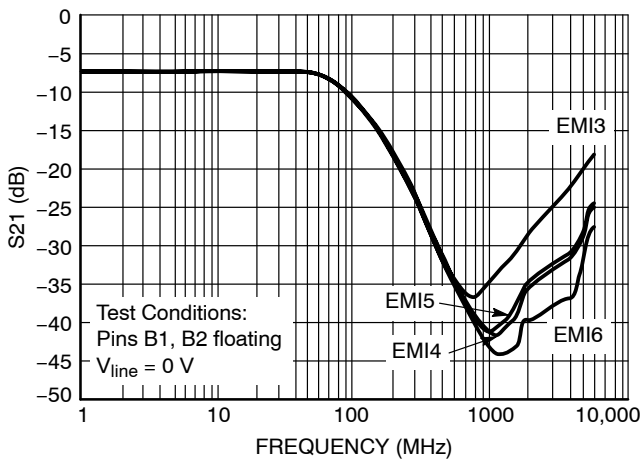

Figure 5. Insertion Loss Characteristic EMI3, EMI4, EMI5, EMI6

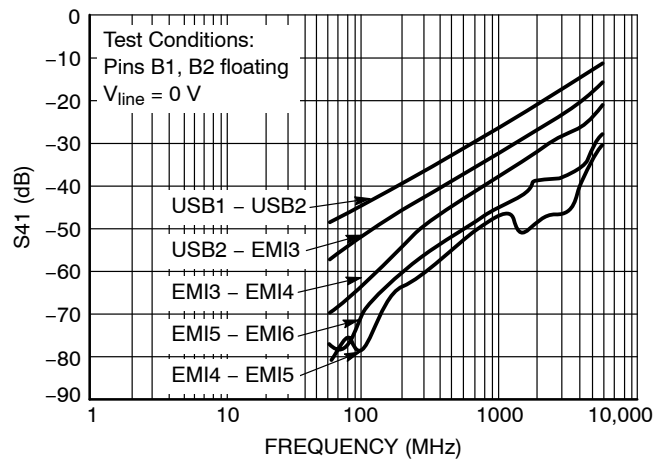

Figure 6. Analog Crosstalk Curve EMI Filter

NUF4107FC

Printed Circuit Board Recommendations

Parameter	500 μm Pitch 300 μm Solder Ball
PCB Pad Size	250 μm +25 -0
Pad Shape	Round
Pad Type	NSMD
Solder Mask Opening	350 μm \pm 25
Solder Stencil Thickness	125 μm
Stencil Aperture	250 x 250 μm sq.
Solder Flux Ratio	50/50
Solder Paste Type	No Clean Type 3 or Finer
Trace Finish	OSP Cu
Trace Width	150 μm Max

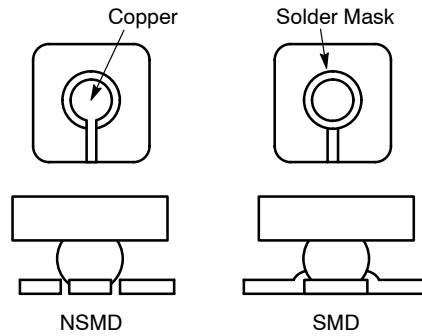

Figure 7. Solder Mask versus Non-Solder Mask Definition

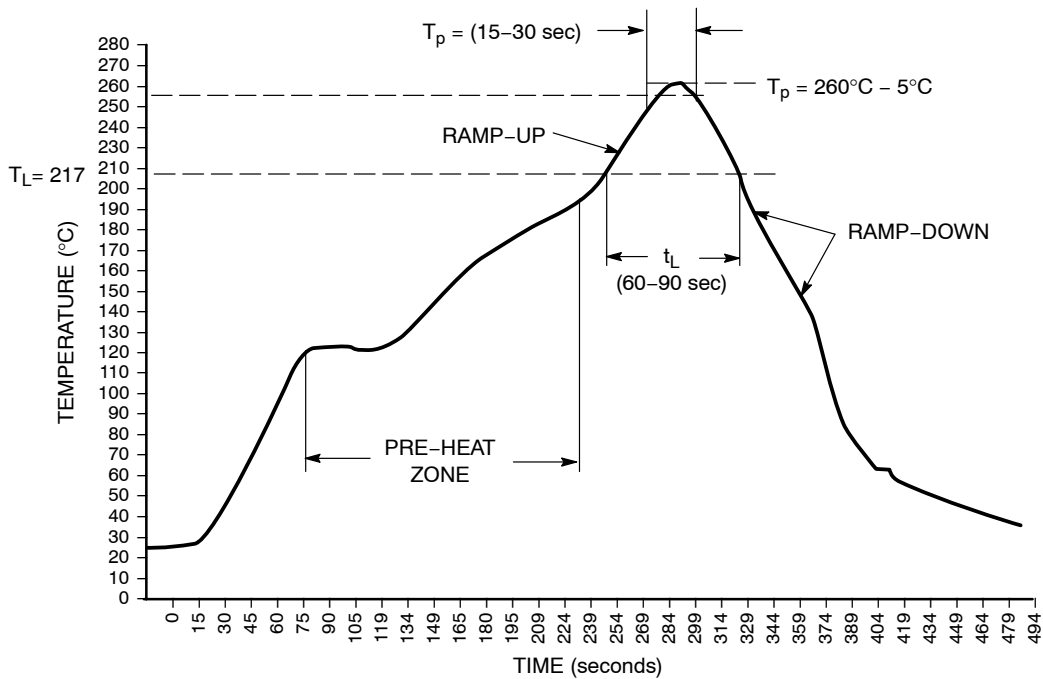
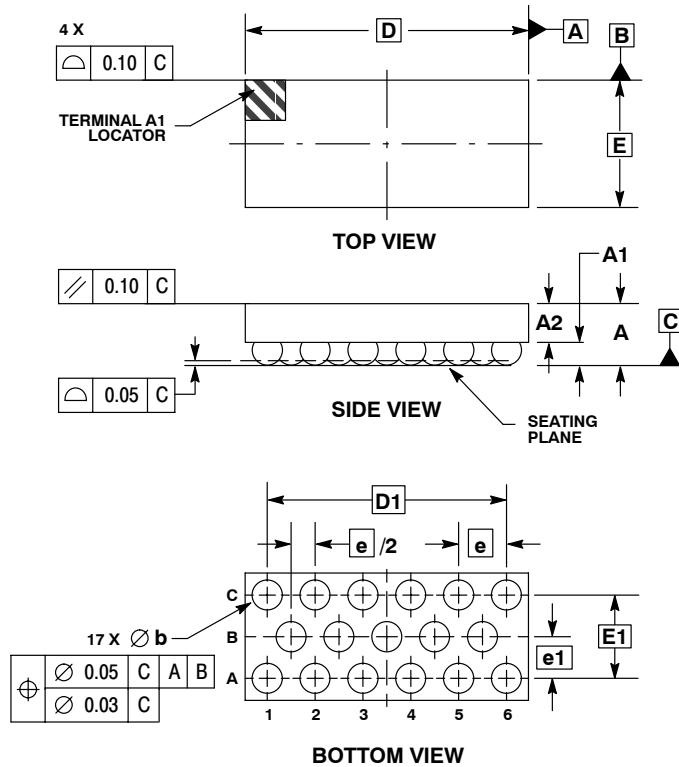

Figure 8. Typical Pb-Free Solder Heating Profile

NUF4107FC

PACKAGE DIMENSIONS

FLIP-CHIP-17 CSP
CASE 499AD-01
ISSUE A



NOTES:

1. DIMENSIONING AND TOLERANCING PER ASME Y14.5M, 1994.
2. CONTROLLING DIMENSION: MILLIMETER.
3. COPLANARITY APPLIES TO SPHERICAL CROWNS OF SOLDER BALLS.

DIM	MILLIMETERS	
	MIN	MAX
A	---	0.740
A1	0.250	0.310
A2	0.380	0.430
D	2.960 BSC	
E	1.330 BSC	
b	0.350	0.410
e	0.500 BSC	
e1	0.435 BSC	
D1	2.500 BSC	
E1	0.870 BSC	

ON Semiconductor and are registered trademarks of Semiconductor Components Industries, LLC (SCILLC). SCILLC reserves the right to make changes without further notice to any products herein. SCILLC makes no warranty, representation or guarantee regarding the suitability of its products for any particular purpose, nor does SCILLC assume any liability arising out of the application or use of any product or circuit, and specifically disclaims any and all liability, including without limitation special, consequential or incidental damages. "Typical" parameters which may be provided in SCILLC data sheets and/or specifications can and do vary in different applications and actual performance may vary over time. All operating parameters, including "Typicals" must be validated for each customer application by customer's technical experts. SCILLC does not convey any license under its patent rights nor the rights of others. SCILLC products are not designed, intended, or authorized for use as components in systems intended for surgical implant into the body, or other applications intended to support or sustain life, or for any other application in which the failure of the SCILLC product could create a situation where personal injury or death may occur. Should Buyer purchase or use SCILLC products for any such unintended or unauthorized application, Buyer shall indemnify and hold SCILLC and its officers, employees, subsidiaries, affiliates, and distributors harmless against all claims, costs, damages, and expenses, and reasonable attorney fees arising out of, directly or indirectly, any claim of personal injury or death associated with such unintended or unauthorized use, even if such claim alleges that SCILLC was negligent regarding the design or manufacture of the part. SCILLC is an Equal Opportunity/Affirmative Action Employer. This literature is subject to all applicable copyright laws and is not for resale in any manner.

PUBLICATION ORDERING INFORMATION

LITERATURE FULFILLMENT:
Literature Distribution Center for ON Semiconductor
P.O. Box 61312, Phoenix, Arizona 85082-1312 USA
Phone: 480-829-7710 or 800-344-3860 Toll Free USA/Canada
Fax: 480-829-7709 or 800-344-3867 Toll Free USA/Canada
Email: orderlit@onsemi.com

N. American Technical Support: 800-282-9855 Toll Free USA/Canada
Japan: ON Semiconductor, Japan Customer Focus Center
2-9-1 Kamimeguro, Meguro-ku, Tokyo, Japan 153-0051
Phone: 81-3-5773-3850

ON Semiconductor Website: <http://onsemi.com>
Order Literature: <http://www.onsemi.com/litorder>
For additional information, please contact your local Sales Representative.