

## LTM4630EY-1 High Efficiency, PolyPhase 70A Step-Down Power $\mu$ Module™ Regulator

### DESCRIPTION

Demonstration Circuit 2164A-A features a PolyPhase® design using the LTM®4630EY-1 (A-grade), the high efficiency, high density, dual 18A, switch mode step-down power module regulator. The input voltage is from 4.5V to 15V. The output voltage is jumper selectable from 0.9V to 1.8V. DC2164A-A can deliver nominal 70A output current. As explained in the data sheet, output current derating is necessary for certain  $V_{IN}$ ,  $V_{OUT}$ , and thermal conditions. The LTM4630-1A on DC2164A-A always operate in continuous conduction mode. The switching frequency can be programmed through a resistor or can be synchronized to an external clock signal. The board allows the user to program how its output voltage ramps up and down through the TRACK pin. The output voltage

is tightly regulated between  $V_{O+}$  and  $V_{O-}$  through remote output voltage sensing which improves output voltage regulation at heavy loads. The LTM4630-1A has  $\pm 0.8\%$  total DC errors. These features and the availability of the LTM4630EY-1 in a compact 16mm  $\times$  16mm  $\times$  5.01mm BGA package make it ideal for use in many high-density point-of-load regulation applications. The LTM4630-1 data sheet must be read in conjunction with this demo manual for working on or modifying the demo circuit DC2164A-A.

**Design files for this circuit board are available at <http://www.linear.com/demo/DC2164A-A>**

LT, LT, LTC, LTM, Linear Technology, the Linear logo,  $\mu$ Module and PolyPhase are registered trademarks of Linear Technology Corporation. All other trademarks are the property of their respective owners.

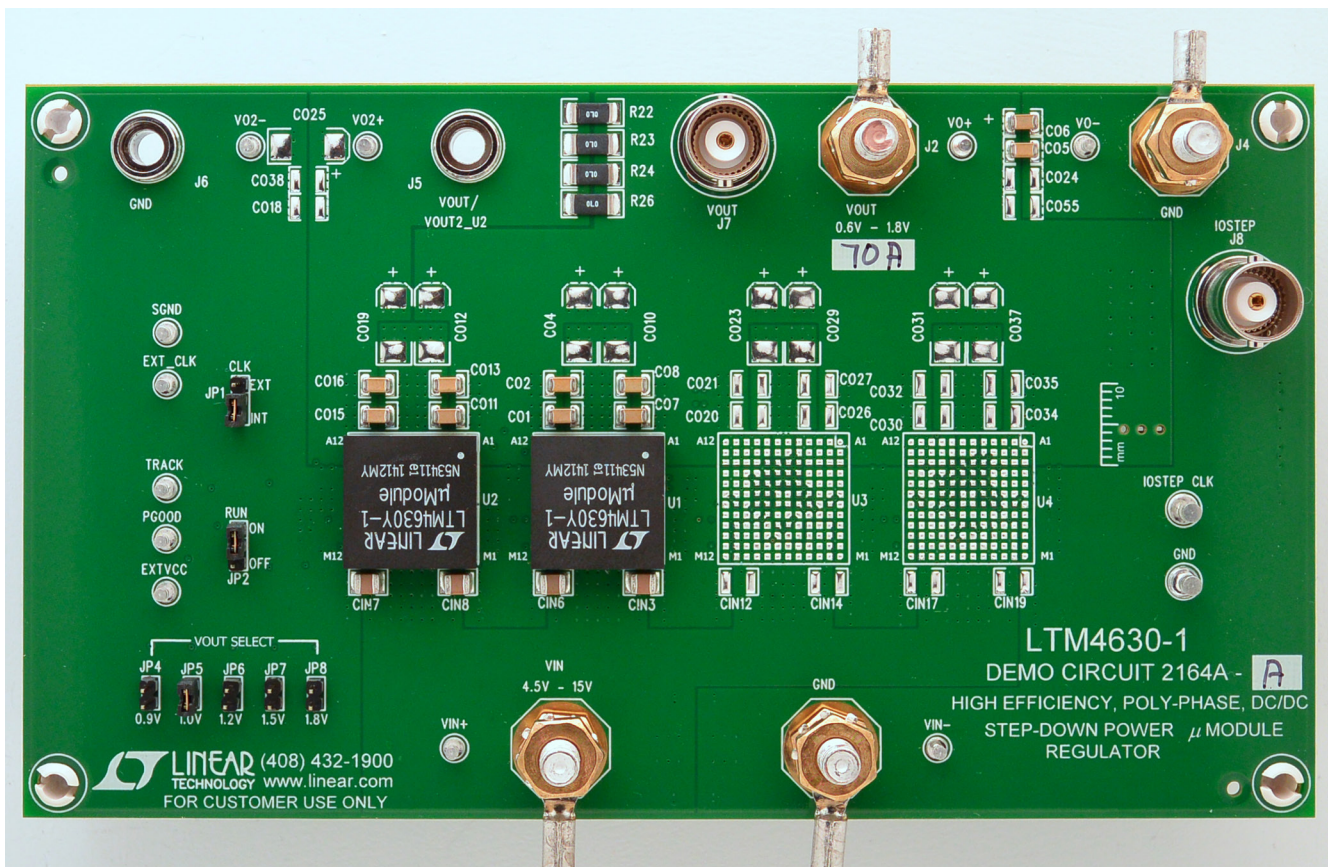

Figure 1. 70A PolyPhase LTM4630-1/DC2164A-A Demo Board

dc2164aafa

# DEMO MANUAL DC2164A-A

## PERFORMANCE SUMMARY Specifications are at T<sub>A</sub> = 25°C

PARAMETER	CONDITIONS	MIN	TYP	MAX	UNITS
Input Voltage Range		4.5		15	V
Output Voltage V <sub>OUT</sub>	V <sub>IN</sub> = 4.5 ~ 15V, I <sub>OUT</sub> = 0A ~ 70A, JP5: 1V		1 ±0.8% (0.992 ~ 1.008)		V
Maximum Continuous Output Current	Derating Is Necessary for Certain V <sub>IN</sub> , V <sub>OUT</sub> and Thermal Conditions, See Data Sheet for Detail		70		A
Default Operating Frequency			400		kHz
Resistor Programmable Frequency Range		400		780	kHz
External Clock Sync. Frequency Range		400		780	kHz
Efficiency	V <sub>IN</sub> = 12V, V <sub>OUT</sub> = 1V, I <sub>OUT</sub> = 70A, f <sub>SW</sub> = 400kHz		83.5 (See Figure 3)		%
Load Transient	V <sub>IN</sub> = 12V, V <sub>OUT</sub> = 1V, I <sub>STEP</sub> = 0A ~ 17.5A		<58.1 (See Figure 4)		mV

## QUICK START PROCEDURE

Demonstration circuit 2164A-A is easy to set up to evaluate the performance of PloyPhase operation of the LTM4630EY-1. Due to the high input/output current, user should select the proper input supply/load/cable which can sustain the full load operation. It's recommended to pull load current from J2 and J4. The load current pulled from J5 and J6 shouldn't exceed 18A. Please refer to Figure 2 for proper measurement setup and follow the procedure below:

- Place jumpers in the following positions for a typical 1V<sub>OUT</sub> application:

JP1	JP2	JP4 ~ JP8
CLK	RUN	VOUT SELECT
INT	OFF	ON JP5/1.0V

- With power off, connect the input power supply, load and meters as shown in Figure 2. Preset the load to 0A and V<sub>IN</sub> supply to 12V.
- Turn on the power supply at the input. Place JP2 to ON position. The output voltage between V<sub>O</sub><sup>+</sup> and V<sub>O</sub><sup>-</sup> should be 1V ±0.8% (0.992V ~ 1.008V).
- Once the proper output voltage is established, adjust the load within the operating range and observe the output voltage regulation, output voltage ripple, efficiency

and other parameters. Output voltage ripple should be measured at J7 with BNC cables. 50Ω termination should be set on the oscilloscope or BNC cables.

- (Optional) For optional load transient test, apply an adjustable pulse signal between IOSTEP CLK and GND test point. Pulse amplitude (3V ~ 3.5V) sets the load step current amplitude. The output transient current can be monitored at the BNC connector J8 (5mV/A). The pulse signal should be very small duty cycle (<10%) to limit the thermal stress on the transient load circuit.
- (Optional) LTM4630-1 can be synchronized to an external clock signal. Place the JP1 jumper on EXT and apply a clock signal (0V ~ 5V, square wave) on the EXT\_CLK test point.
- (Optional) The outputs of LTM4630-1 can track another supply. The output voltage tracks the voltage on TRACK when a valid signal is applied on the test point.
- (Optional) DC2164A-A can be configured to a dual outputs configuration with V<sub>O</sub> at 52A load current and V<sub>O2</sub> at 18A load current. Stuff 0Ω resistor on R61 and 0.1μF on C14. Remove R22, R23, R24, R26, R27, R28, R32, R33, R35. Output voltage V<sub>O2</sub> is set by R37 based on the equation V<sub>O2</sub> = 0.6V(1 + 60.4k/R37).

## QUICK START PROCEDURE

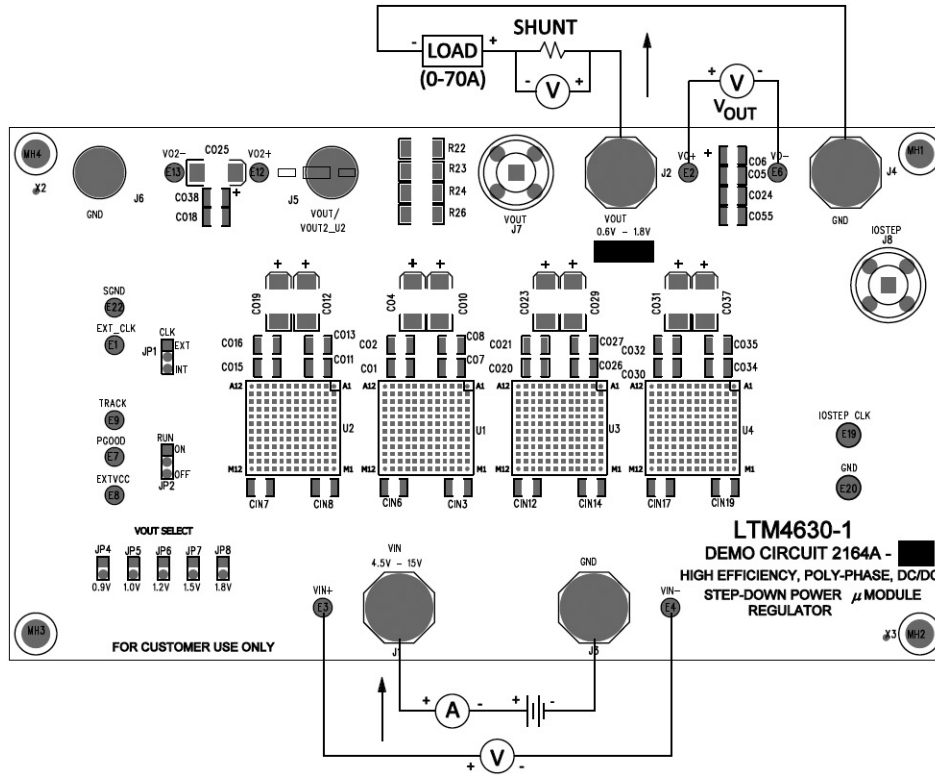

Figure 2. Test Setup of DC2164A-A

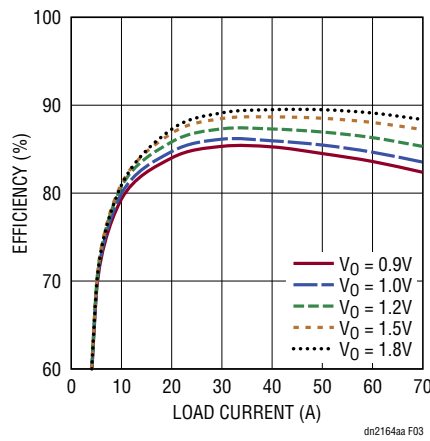

Figure 3. Measured Efficiency  $V_{IN} = 12V$ ,  $f_{SW} = 400kHz$

## QUICK START PROCEDURE

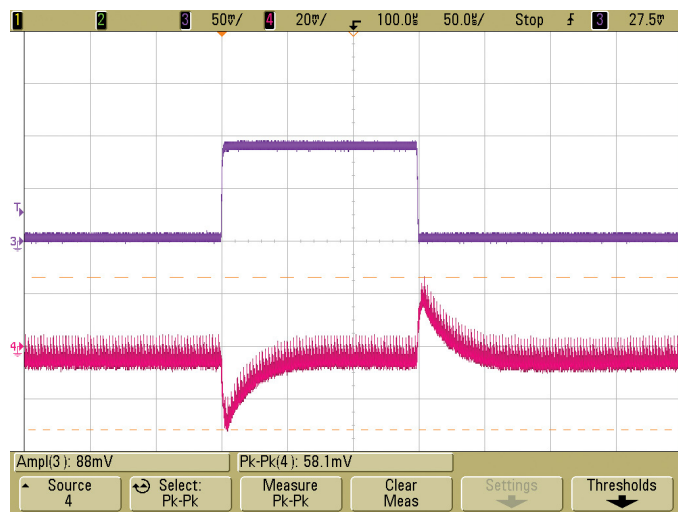

Figure 4. Load Transient 0A to 17.5A ( $V_{IN} = 12V$ ,  $V_{OUT} = 1V$ )

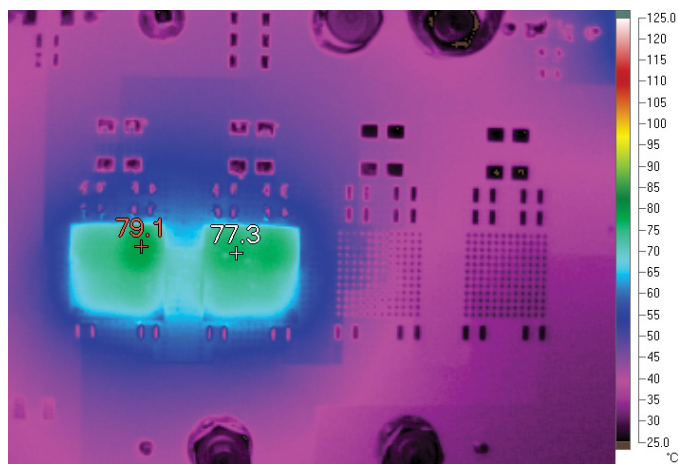

Figure 5. Thermal Capture at 12V<sub>IN</sub>, 1V<sub>OUT</sub>, 70A ( $T_A = 25^\circ C$ , 400 LFM Airflow and No Heat Sink)

## PARTS LIST

ITEM	QTY	REFERENCE	PART DESCRIPTION	MANUFACTURER/PART NUMBER
<b>Required Circuit Components</b>				
1	1	CIN1	CAP, 150μF 25% 25V ALUM	SUN ELECT., 25CE150AX
2	2	CIN2, CIN11	CAP, 1206 1μF 10% 25V X5R	TAIYO YUDEN, TMK316BJ105KL-T
3	8	CIN3-CIN10	CAP, 1210 22μF 10% 25V X5R	AVX, 12103D226KAT2A
4	12	C01, C02, C05, C06, C07, C08, C011, C013, C015, C016, C056, C057	CAP, 1206 220μF 20% 4V X5R	MURATA, GRM31CR60G227ME11L
5	1	C1	CAP, 0603 330pF 10% 50V NPO	AVX, 06035A331KAT2A
6	4	C4, C10, C18, C22	CAP, 0603 2.2μF 20% 10V X5R	TAIYO YUDEN, LMK107BJ225MA-T
7	6	C6, C11, C19, C23, C27, C28	CAP, 0603 1μF 10% 10V X7R	TAIYO YUDEN, LMK107BJ105KA-T
8	2	C7, C25	CAP, 0603 0.1μF 10% 25V X7R	AVX, 06033C104KAT2A
9	2	C24, C31	CAP, 0603 0.01μF 10% 100V X7R	AVX, 06031C103KAT2A
10	2	Q1, Q2	MOSFET, N-CH D-S 30V T0252	VISHAY, SUD50N04-8M8P-4GE3
11	4	R1, R3, R25, R29	RES, 0603 10Ω 5% 1/10W	VISHAY, CRCW060310R0JNEA
12	5	R2, R14, R21, R39, R47	RES, 0603 121k 1% 1/10W	VISHAY, CRCW0603121KFKEA
13	4	R4, R36, R41, R54	RES, 0603 10k 5% 1/10W	VISHAY, CRCW060310K0JNEA
14	4	R9, R31, R43, R51	RES, 0603 100k 1% 1/10W	VISHAY, CRCW0603100KFKEA
15	1	R11	RES, 0603 2.32k 1% 1/10W	VISHAY, CRCW06032K32FKEA
16	1	R15	RES, 0603 90.9k 1% 1/10W	VISHAY, CRCW060390K9FKEA
17	1	R16	RES, 0603 60.4k 1% 1/10W	VISHAY, CRCW060360K4FKEA
18	1	R17	RES, 0603 40.2k 1% 1/10W	VISHAY, CRCW060340K2FKEA
19	1	R18	RES, 0603 30.1k 1% 1/10W	VISHAY, CRCW060330K1FKEA
20	2	R56, R57	RES, 2512 0.010Ω 1% 1W	VISHAY, WSL2512R01000FEA
21	2	U1, U2	IC, VOLTAGE REGULATOR, BGA	LINEAR TECH., LTM4630IY-1A#PBF



## PARTS LIST

ITEM	QTY	REFERENCE	PART DESCRIPTION	MANUFACTURER/PART NUMBER
<b>Additional Demo Board Circuit Components</b>				
1	0	CIN12-CIN19	DO NOT STUFF	
2	0	C03, C09, C014, C017, C018, C020, C021, C022, C024, C026, C027, C028, C030, C032-C036, C038, C040, C042, C045, C046, C048, C050, C052, C054, C055, C058, C059	CAP, 1210 OPTION	OPTION
3	0	C04, C010, C012, C019, C023, C025, C029, C031, C037	CAP, 7343 OPTION	OPTION
		C039, C041, C043, C044, C047, C049, C051, C053,		
4	0	C2, C3, C5, C8, C9, C12-, C17, C20, C21, C26, C29, C30, C32	CAP, 0603 OPTION	OPTION
5	0	R5, R7, R8, R10, R30, R37, R38, R42, R44, R48-R50, R52, R53, R55, R61, R64	RES, 0603 OPTION	OPTION
6	0	R13, R34	RES, 0603 OPTION	OPTION
7	12	R6, R19, R20, R27, R28, R32, R33, R35, R40, R45, R62, R63	RES, 0603 0Ω JUMPER	VISHAY, CRCW06030000Z0EA
8	4	R22, R23, R24, R26	RES, 2010 0Ω JUMPER	VISHAY, CRCW20100000ZEA9
9	0	R58, R59	RES, 2512 OPTION	OPTION
10	1	R60	RES, 1206 0Ω JUMPER	VISHAY, CRCW12060000Z0EA
11	0	U3, U4	DO NOT STUFF	
<b>Hardware: For Demo Board Only</b>				
1	11	E1-E4, E6-E9, E12, E13, E22	TESTPOINT, TURRET, 0.063"	MILL MAX, 2308-2-00-80-00-00-07-0
2	2	E19, E20	TESTPOINT, TURRET, 0.094"	MILL MAX, 2501-2-00-80-00-00-07-0
3	2	JP1, JP2	HEADER, 3 PIN 0.079 SINGLE ROW	SULLINS, NRPN031PAEN-RC
4	5	JP4, JP5, JP6, JP7, JP8	HEADER, 2 PIN 0.079 SINGLE ROW	SAMTEC, TMM-102-02-L-S
5	4	J1, J2, J3, J4	STUD, TEST PIN	PEM, KFH-032-10
6	8	J1, J2, J3, J4 (x2)	NUT, BRASS PL # 10-32	ANY, 10-32M/S BR PL
7	4	J1, J2, J3, J4	LUG RING, #10	KEYSTONE, 8205
8	4	J1, J2, J3, J4	WASHER, TIN PLATED BRASS	ANY, #10EXT BZ TN
9	2	J5, J6	JACK, BANANA	KEYSTONE, 575-4
10	2	J7, J8	CON, BNC, 5 PINS	CONNEX, 112404
11	3	XJP1, XJP2, XJP4	SHUNT	SAMTEC, 2SN-BK-G

# DEMO MANUAL DC2164A-A

## SCHEMATIC DIAGRAM

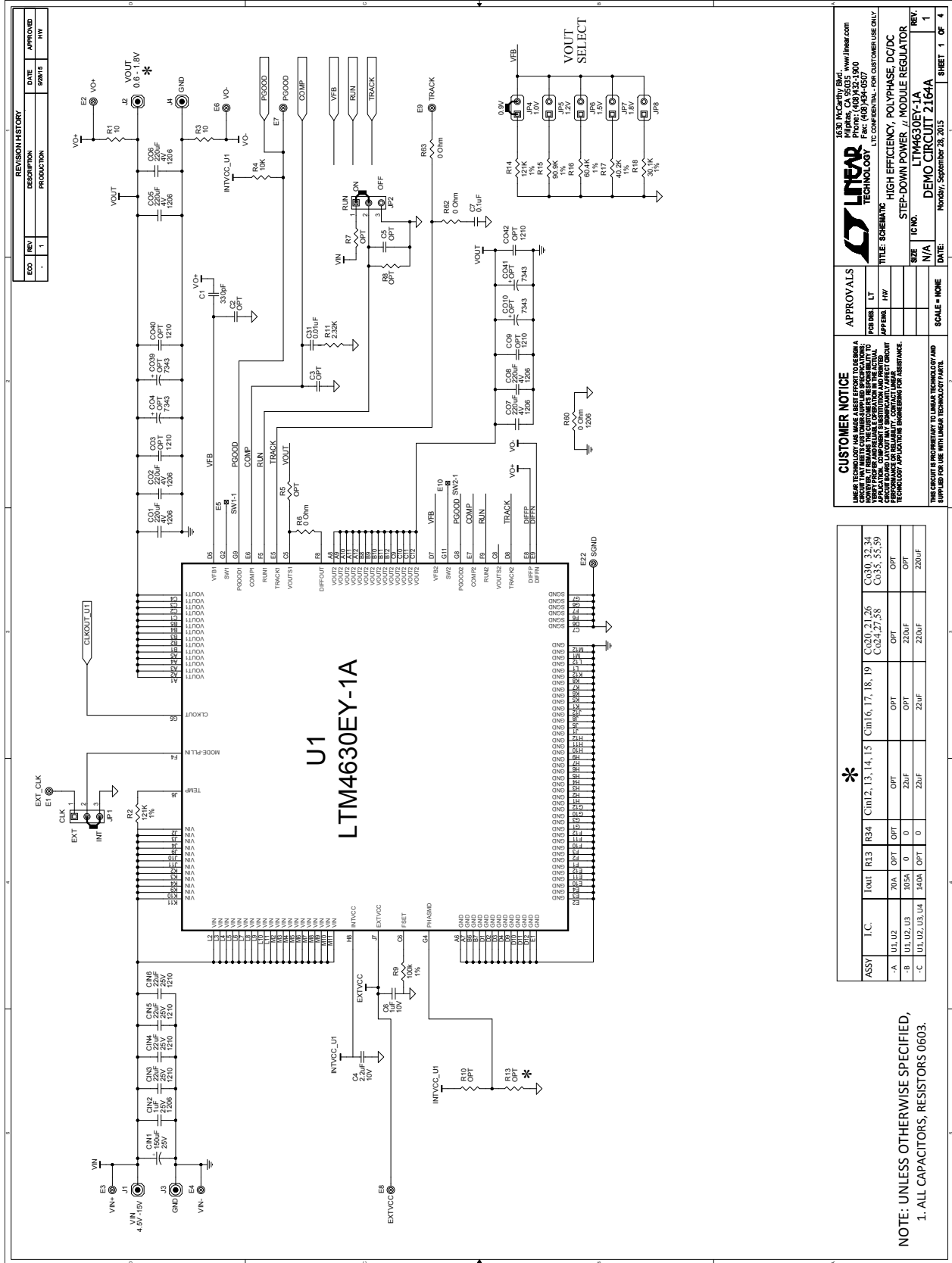

ASSY	I.C.	lot	R13	R84	Cin1	12, 13, 14, 15	Cin1	16, 17, 18, 19	Cin2	20, 21, 26	Cin3	22, 23, 24	Cin4	25, 28	Cin5	29, 30	Cin6	31, 32, 33, 34
-A	U1-U2	70A	OPT	OPT	OPT	OPT	OPT	OPT	OPT	OPT	OPT	OPT	OPT	OPT	OPT	OPT	OPT	OPT
-B	U1-U2-U3	105A	0	0	20uF	0	0	0	0	220nF	220nF	220nF	220nF	220nF	220nF	220nF	220nF	220nF
-C	U1-U2-U3-U4	140A	OPT	0	22uF	0	0	0	0	22uF	220nF	220nF	220nF	220nF	220nF	220nF	220nF	220nF

NOTE: UNLESS OTHERWISE SPECIFIED,  
 1. ALL CAPACITORS, RESISTORS 0603.

## SCHEMATIC DIAGRAM

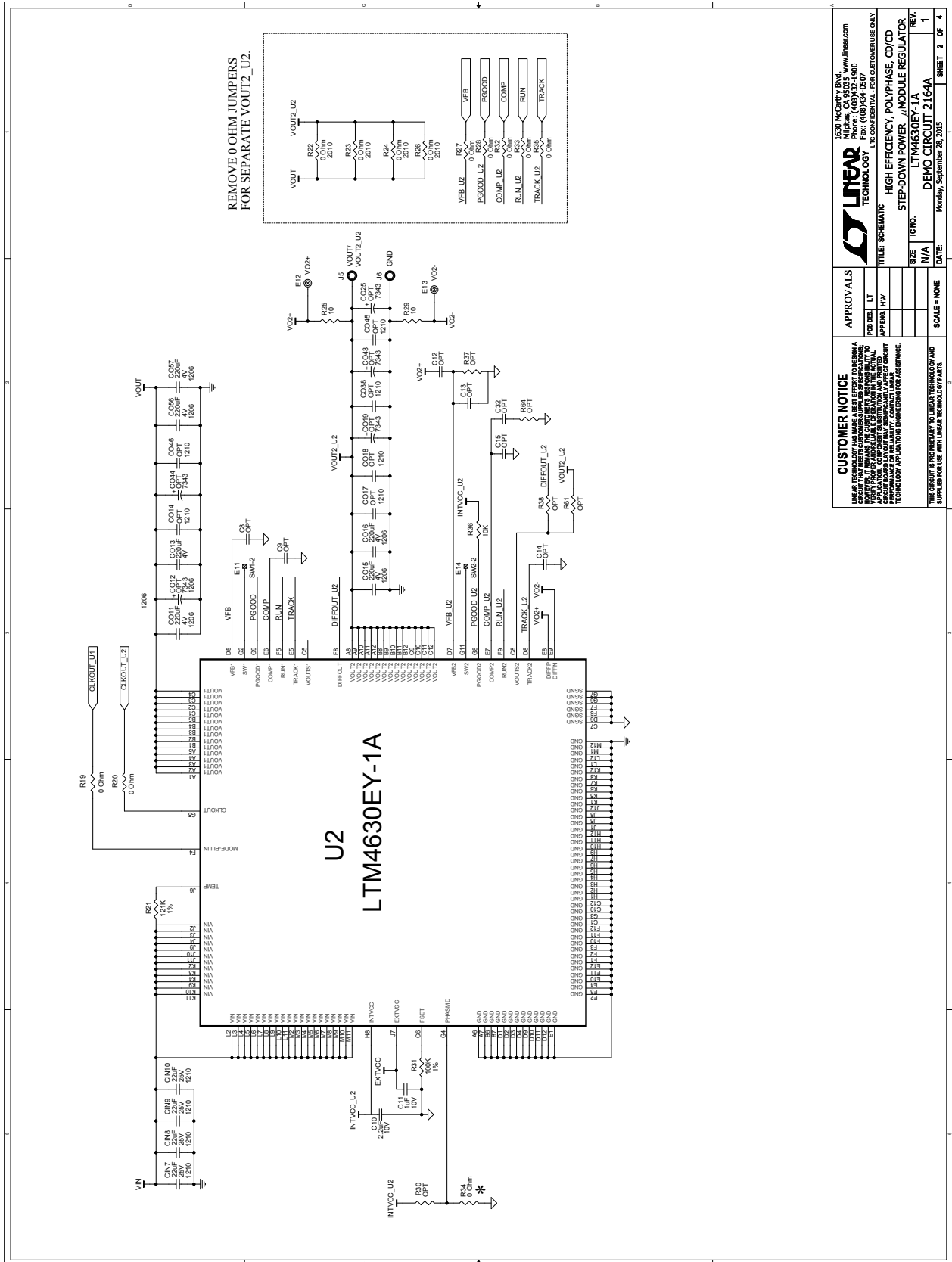

# DEMO MANUAL DC2164A-A

## SCHEMATIC DIAGRAM

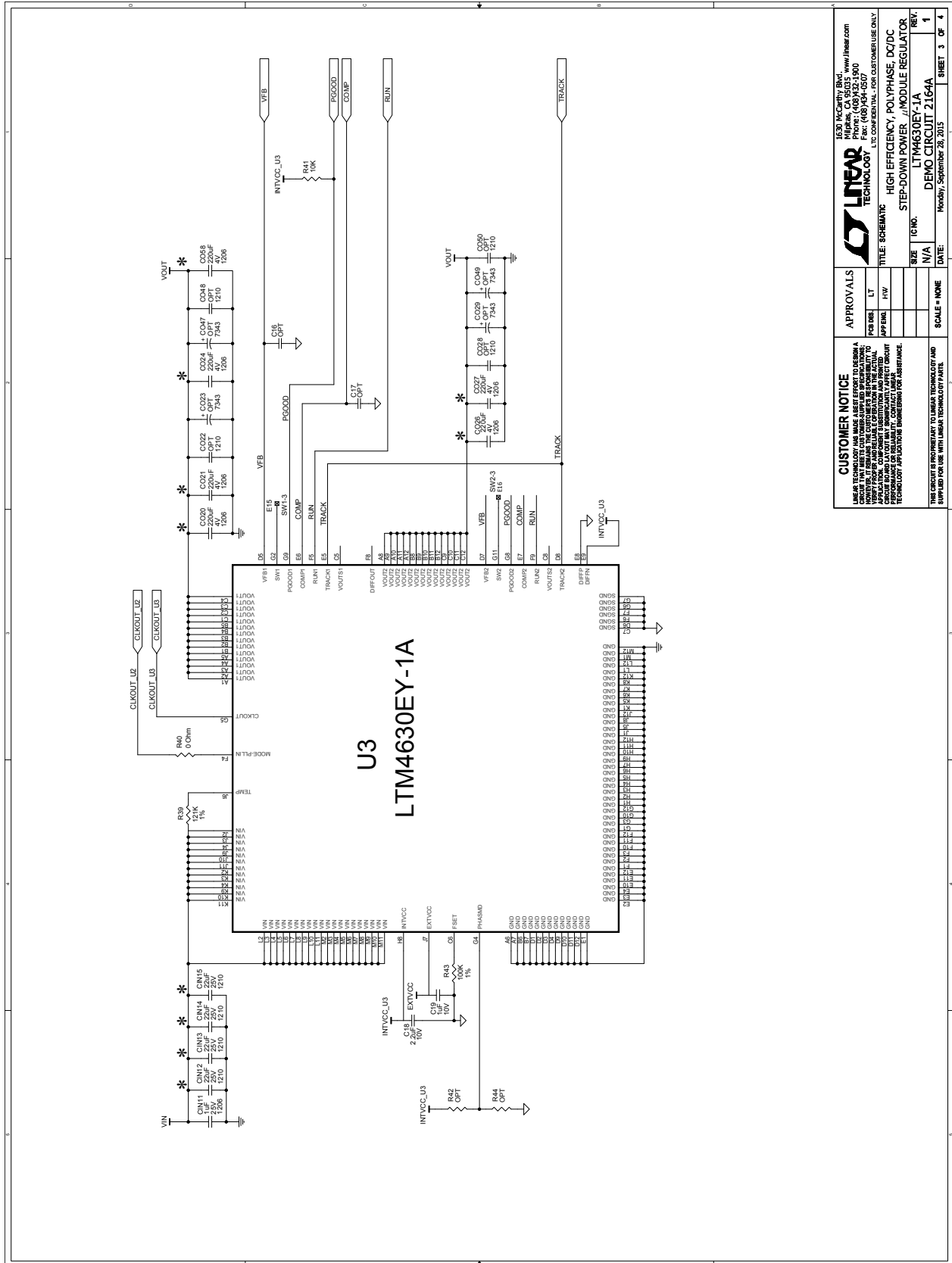

dc2164aafa



## SCHEMATIC DIAGRAM

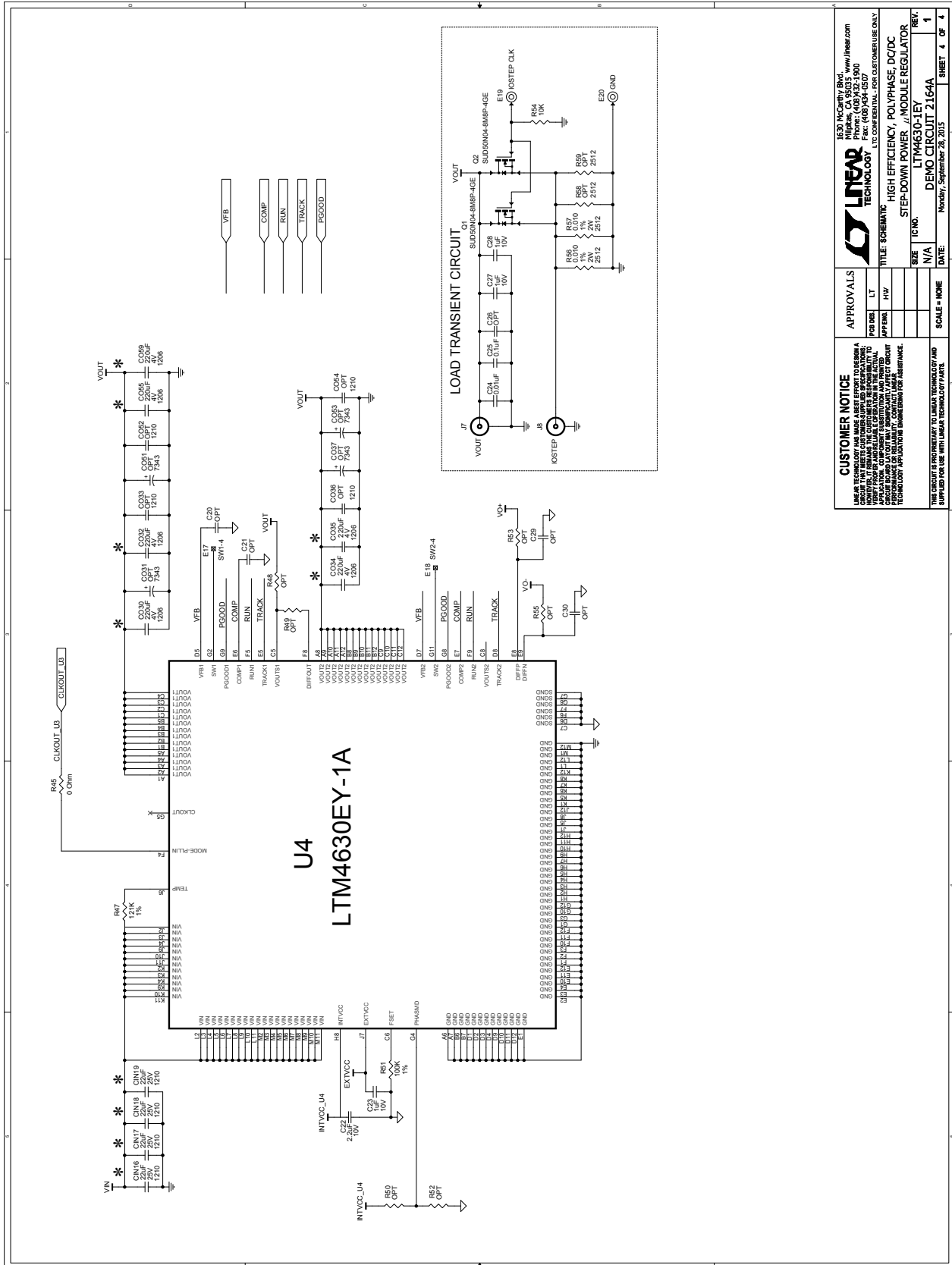

dc2164aafa

# DEMO MANUAL DC2164A-A

---

## DEMONSTRATION BOARD IMPORTANT NOTICE

Linear Technology Corporation (LTC) provides the enclosed product(s) under the following **AS IS** conditions:

This demonstration board (DEMO BOARD) kit being sold or provided by Linear Technology is intended for use for **ENGINEERING DEVELOPMENT OR EVALUATION PURPOSES ONLY** and is not provided by LTC for commercial use. As such, the DEMO BOARD herein may not be complete in terms of required design-, marketing-, and/or manufacturing-related protective considerations, including but not limited to product safety measures typically found in finished commercial goods. As a prototype, this product does not fall within the scope of the European Union directive on electromagnetic compatibility and therefore may or may not meet the technical requirements of the directive, or other regulations.

If this evaluation kit does not meet the specifications recited in the DEMO BOARD manual the kit may be returned within 30 days from the date of delivery for a full refund. **THE FOREGOING WARRANTY IS THE EXCLUSIVE WARRANTY MADE BY THE SELLER TO BUYER AND IS IN LIEU OF ALL OTHER WARRANTIES, EXPRESSED, IMPLIED, OR STATUTORY, INCLUDING ANY WARRANTY OF MERCHANTABILITY OR FITNESS FOR ANY PARTICULAR PURPOSE. EXCEPT TO THE EXTENT OF THIS INDEMNITY, NEITHER PARTY SHALL BE LIABLE TO THE OTHER FOR ANY INDIRECT, SPECIAL, INCIDENTAL, OR CONSEQUENTIAL DAMAGES.**

The user assumes all responsibility and liability for proper and safe handling of the goods. Further, the user releases LTC from all claims arising from the handling or use of the goods. Due to the open construction of the product, it is the user's responsibility to take any and all appropriate precautions with regard to electrostatic discharge. Also be aware that the products herein may not be regulatory compliant or agency certified (FCC, UL, CE, etc.).

No License is granted under any patent right or other intellectual property whatsoever. **LTC assumes no liability for applications assistance, customer product design, software performance, or infringement of patents or any other intellectual property rights of any kind.**

LTC currently services a variety of customers for products around the world, and therefore this transaction **is not exclusive**.

**Please read the DEMO BOARD manual prior to handling the product.** Persons handling this product must have electronics training and observe good laboratory practice standards. **Common sense is encouraged.**

This notice contains important safety information about temperatures and voltages. For further safety concerns, please contact a LTC application engineer.

Mailing Address:

Linear Technology  
1630 McCarthy Blvd.  
Milpitas, CA 95035

Copyright © 2004, Linear Technology Corporation