

EVB9S08DZ128

(EVB9S08DZ60/128, DB9S08D-100LQFP)

Schematic and Bill of Material

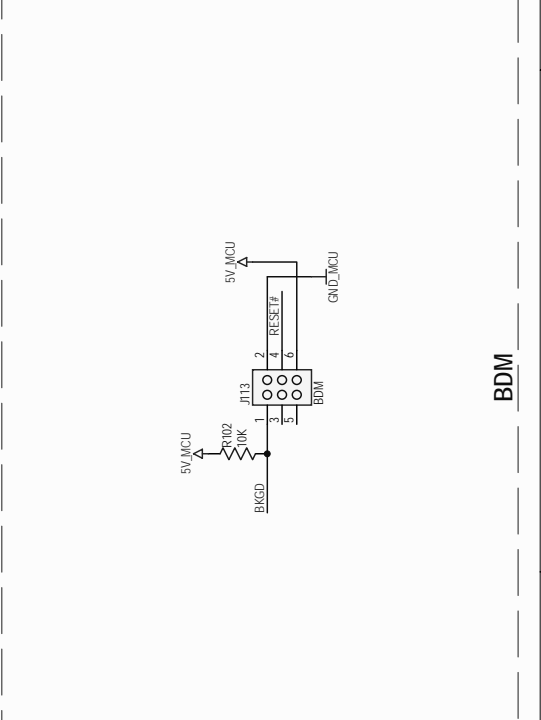

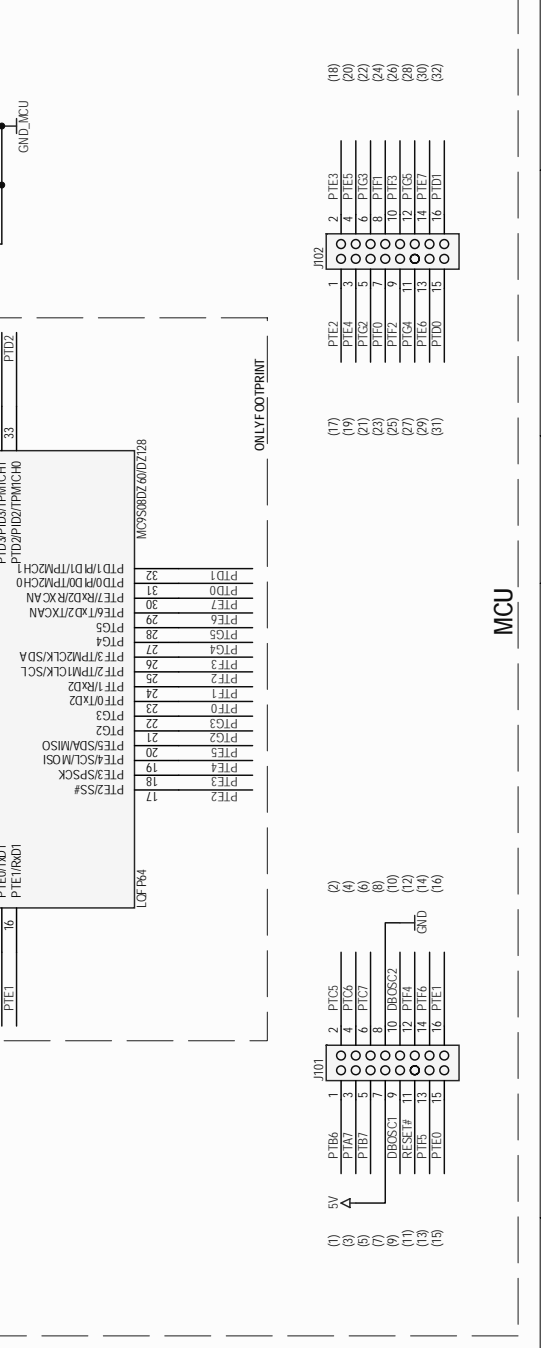
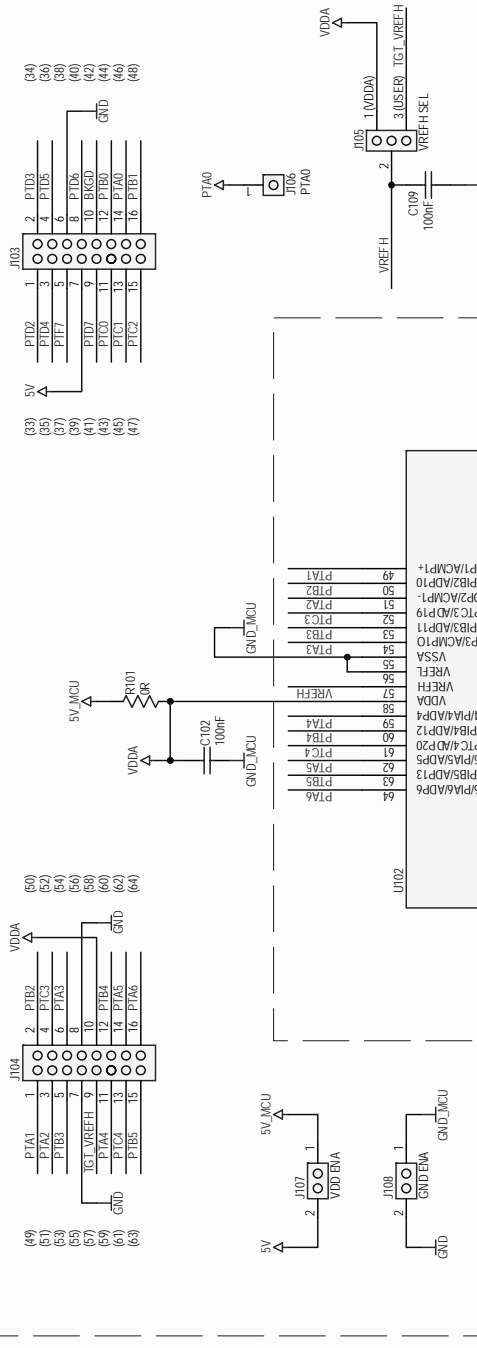
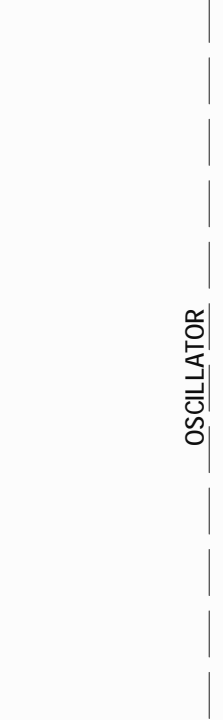
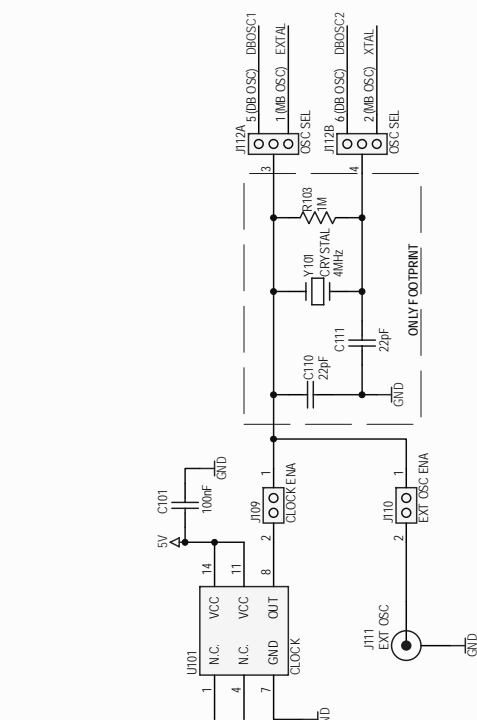
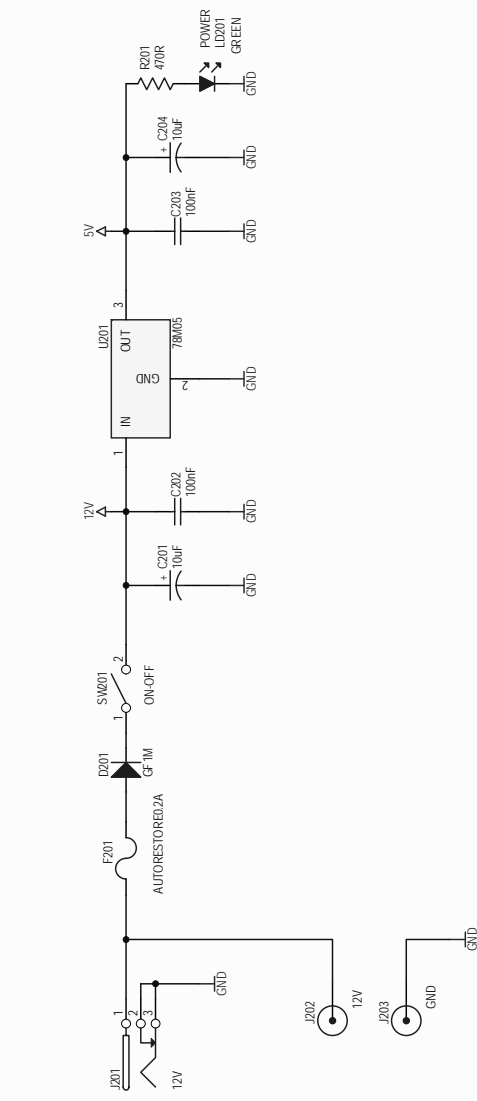

POWER SUPPLY

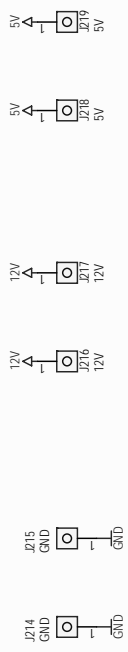

PROTOTYPE AREA

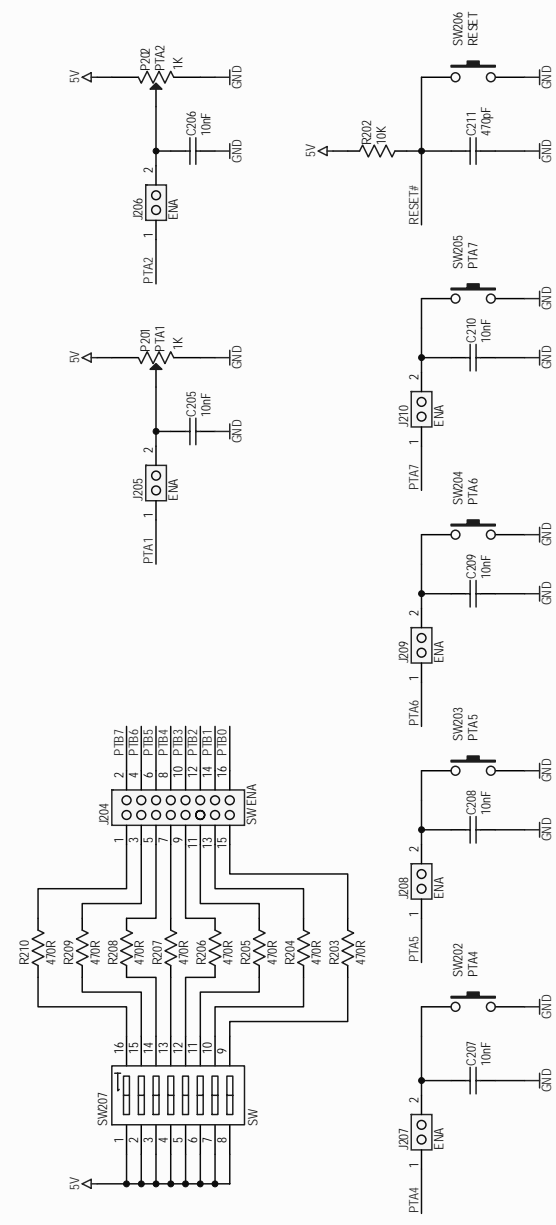
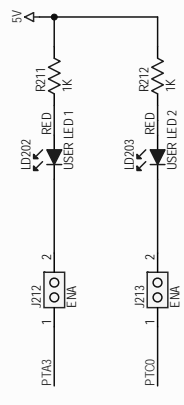

INPUTS

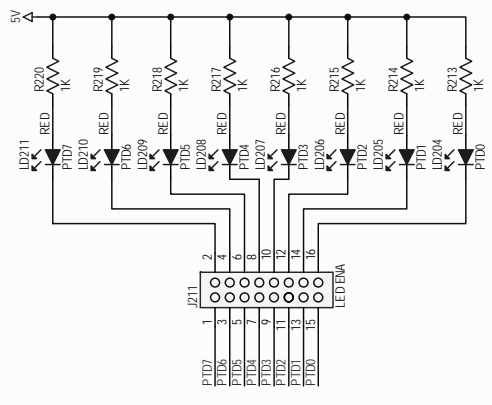

OUTPUTS



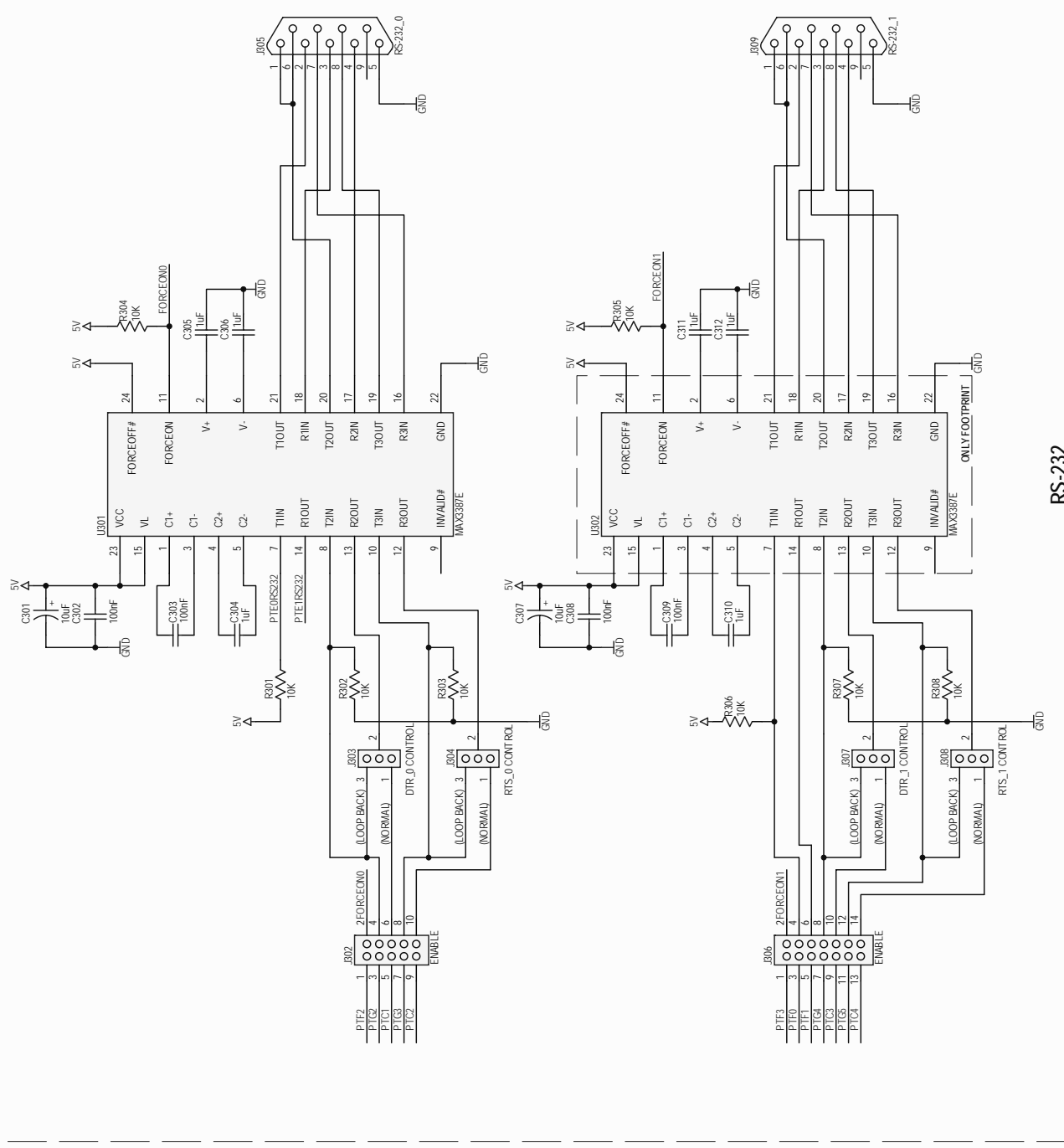

RS-232

SERIAL SETTINGS

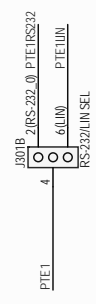
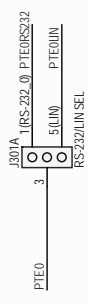

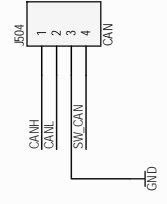
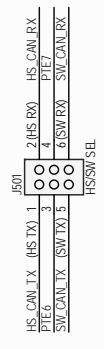
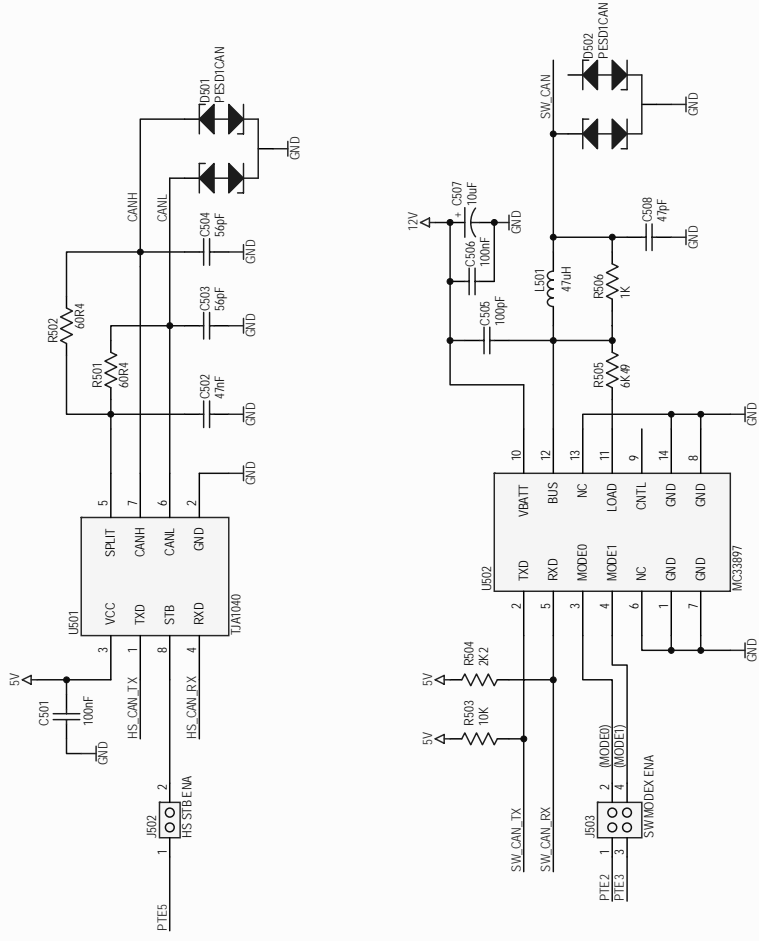

CAN

EVB9S08DZ60/128 Bill of Material

Qty	Description	Ref. Designators	Vendor Part#
Capacitors			
20	Ceramic Capacitor 100nF X7R 50V 0805	C101, C102, C103, C106, C109, C202, C203, C302, C303, C308, C309, C401, C501, C506, C604, C606, C607, C608, C610, C611	Walsin, 0805B104K500CT
1	Ceramic Capacitor 100pF X7R 50V 0805	C505	Walsin, 0805B101K500CT
8	Ceramic Capacitor 10nF X7R 50V 0805	C105, C108, C205, C206, C207, C208, C209, C210	Walsin, 0805B103K500CT
7	Ceramic Capacitor 1uF X7R 25V 0805	C304, C305, C306, C310, C311, C312, C403	Walsin, 0805B105K250CT
2	Ceramic Capacitor 22pF NP0 50V 0805	C601, C602	Walsin, 0805N220K500CT
2	Ceramic Capacitor 470pF X7R 50V 0805	C211, C402	Walsin, 0805B471J500CT
1	Ceramic Capacitor 47nF X7R 50V 0805	C502	Walsin, 0805B473K500CT
1	Ceramic Capacitor 47pF NP0 50V 0805	C508	Walsin, 0805N470J500CT
2	Ceramic Capacitor 56pF NP0 50V 0805	C503, C504	Walsin, 0805N560J500CT
10	Tantalum Capacitor 10uF 16V size B	C104, C107, C201, C204, C301, C307, C507, C603, C605, C609	NIC Components, NTC-T106M16TRBF
Connectors			
1	BNC Connector 90° Pcb plastic body pitch 2,54mm	J111	Amphenol, 31-5538
1	Box Header Connector 6 way male straight solder pitch 2,54mm	J113	Coxoc, 302A-06PGAS003
1	DC Power Connector 2.1 mm male 90° PCB mounting	J201	Samar, 22HP037
1	DC Power Connector black banana plug 10A 4mm PCB 90°	J203	Deltron Emcon, 571-0100-01
1	DC Power Connector red banana plug 10A 4mm PCB 90°	J202	Deltron Emcon, 571-0500-01
2	D-Sub Connector female 90° 9-pin	J305, J309	Coxoc, 205A-09FSTUBE3
1	Header Connector 1x1 pin male gold straight 6mm pitch 2,54mm	J403	Coxoc, 307A-040GASAA3
14	Header Connector 2x1 pin male gold straight 6mm pitch 2,54mm	J107, J108, J109, J110, J205, J206, J207, J208, J209, J210, J212, J213, J404, J502	Coxoc, 307A-040GASAA3
2	Header Connector 2x2 pin male gold straight 6mm pitch 2,54mm	J503, J602	Coxoc, 307A-080GBSAA3
5	Header Connector 3x1 pin male gold straight 6mm pitch 2,54mm	J105, J303, J304, J307, J308	Coxoc, 307A-040GASAA3
3	Header Connector 3x2 pin male gold straight 6mm pitch 2,54mm	J112, J301, J501	Coxoc, 307A-080GBSAA3
1	Header Connector 5x2 pin male gold straight 6mm pitch 2,54mm	J302	Coxoc, 307A-080GBSAA3
1	Header Connector 7x2 pin male gold straight 6mm pitch 2,54mm	J306	Coxoc, 307A-080GBSAA3
6	Header Connector 8x2 pin male gold straight 6mm pitch 2,54mm	J101, J102, J103, J104, J204, J211	Coxoc, 307A-080GBSAA3
2	Mini-Fit Connector Molex 5569 series 4 way 90° dual row pitch 4,20mm	J401, J402	Molex, 39-29-5043
1	Mini-Fit Connector Molex 5569 series 4 way 90° single row pitch 4,20mm	J504	Molex, 39-30-3047
7	PCB Terminal Connector black hole size1,32mm 1-pin	J106, J214, J215, J216, J217, J218, J219	William Hughes, 100-103
57	Shunt jumper 2,54mmmm totally insulated black pitch 2,54mm		Coxoc, 308A02PGBA003
1	USB Connector Receptacle Type B 90° 4-pin	J601	Coxoc, 317A-04PSB0003
Crystals			
1	SMD Crystal 12MHz HC-49USMD (11x5x3)	Y601	Megatec, HC49/USM4-012M000000CR
Diodes			

Qty	Description	Ref. Designators	Vendor Part#
3	Rectifier Diode GF1M SMA	D201, D401, D402	Fairchild Semiconductor, GF1M
5	Schottky Diode BAT54S SOT23	D403, D404, D405, D601, D602	Philips Semiconductors, BAT54S
3	TVS Diode PESD1CAN SOT23	D406, D501, D502	Philips Semiconductors, 9340 590 97215
Fuses			
1	Autorestore Fuse 0,2A 1812	F201	Raychem Circuit Protection, miniSMDC020-2
Inductors			
1	SMD Inductor 47uH 0,88A 2-pin	L501	Würth, 744777147
Integrated Circuits			
1	IC Microcontroller MC9S12UF32 QFP100	U601	Freescale, MC9S12UF32PU
1	IC Transceiver CAN TJA1040 SOIC8	U501	Philips Semiconductors, TJA1040T
1	IC Transceiver LIN TJA1020 SOIC8	U401	Philips Semiconductors, TJA1020T
1	IC Transceiver MC33897 Single Wire Can SOIC14	U502	Freescale, MC33897CEF/R2
1	IC Transceiver RS-232 MAX3387E TSSOP24	U301	Maxim, MAX3387ECUG
1	IC Voltage Regulator LM78M05 5V TO252 (DPAK)	U201	National Semiconductor, LM78M05CDT
LEDs			
2	SMD LED Green 1206	LD201, LD401	Agilent Technologies, HSMG-C150
10	SMD LED Red 1206	LD202, LD203, LD204, LD205, LD206, LD207, LD208, LD209, LD210, LD211	Agilent Technologies, HSMH-C150
Potentiometers			
2	Potentiometer 1K vertical adjust	P201, P202	Phier, PT10MVP102A2020
Resistors			
1	SMD Resistor 0R 5% 1/8W 0805	R101	Kamaya, RMC1/10JPTP
1	SMD Resistor 1,5K 1% 0805	R603	Kamaya, RMC1/10K1501FTP
2	SMD Resistor 100K 1% 0805	R405, R608	Kamaya, RMC1/10K1003FTP
2	SMD Resistor 100R 1% 0805	R610, R611	Kamaya, RMC1/10K1000FTP
20	SMD Resistor 10K 1% 0805	R102, R202, R301, R302, R303, R304, R305, R306, R307, R308, R401, R402, R403, R404, R407, R410, R503, R606, R607, R609	Kamaya, RMC1/10K1002FTP
1	SMD Resistor 1K 1206	R406	Kamaya, RMC1/8K102FTP
14	SMD Resistor 1K 1% 1/8W 0805	R211, R212, R213, R214, R215, R216, R217, R218, R219, R220, R408, R409, R411, R506	Kamaya, RMC1/10K102FTP
1	SMD Resistor 1M 1% 0805	R605	Kamaya, RMC1/10K1004FTP
1	SMD Resistor 2,2K 1% 1/8W 0805	R504	Kamaya, RMC1/10K2201FTP
2	SMD Resistor 33R 1% 0805	R601, R602	Kamaya, RMC1/10K33R0FTP
9	SMD Resistor 470R 1% 0805	R201, R203, R204, R205, R206, R207, R208, R209, R210	Kamaya, RMC1/10K4700FTP
1	SMD Resistor 510R 1% 0805	R604	Kamaya, RMC1/10K5100FTP
2	SMD Resistor 60,4R 1% 0805	R501, R502	Kamaya, RMC1/10K60R4FTP
1	SMD Resistor 6K49 1/8W 1% 0805	R505	Yageo, 9T08052A6491FBHFT
Sockets			
1	IC Socket Tulip pitch 2,54mm DIP14	U101	Preci-dip, 110-87-314-41-001101
Switches			
1	DIP Switch PTH low profile 8 positions DIP16	SW207	Tyco, 2-1437586-6
6	Pushbutton Switch SMD	SW202, SW203, SW204, SW205, SW206, SW401	Augat, FSM4JSMA
1	Slide Switch Slide Switch for PCB 3-pin	SW201	Eledis, 7A11-A1STSE2
Transistors			
1	NMOS Transistor BSS138 SOT23	Q402	On Semiconductor, BSS138LT1G

Qty	Description	Ref. Designators	Vendor Part#
1	PMOS Transistor NDS0605 SOT23	Q401	Fairchild Semiconductor, NDS0605_NL

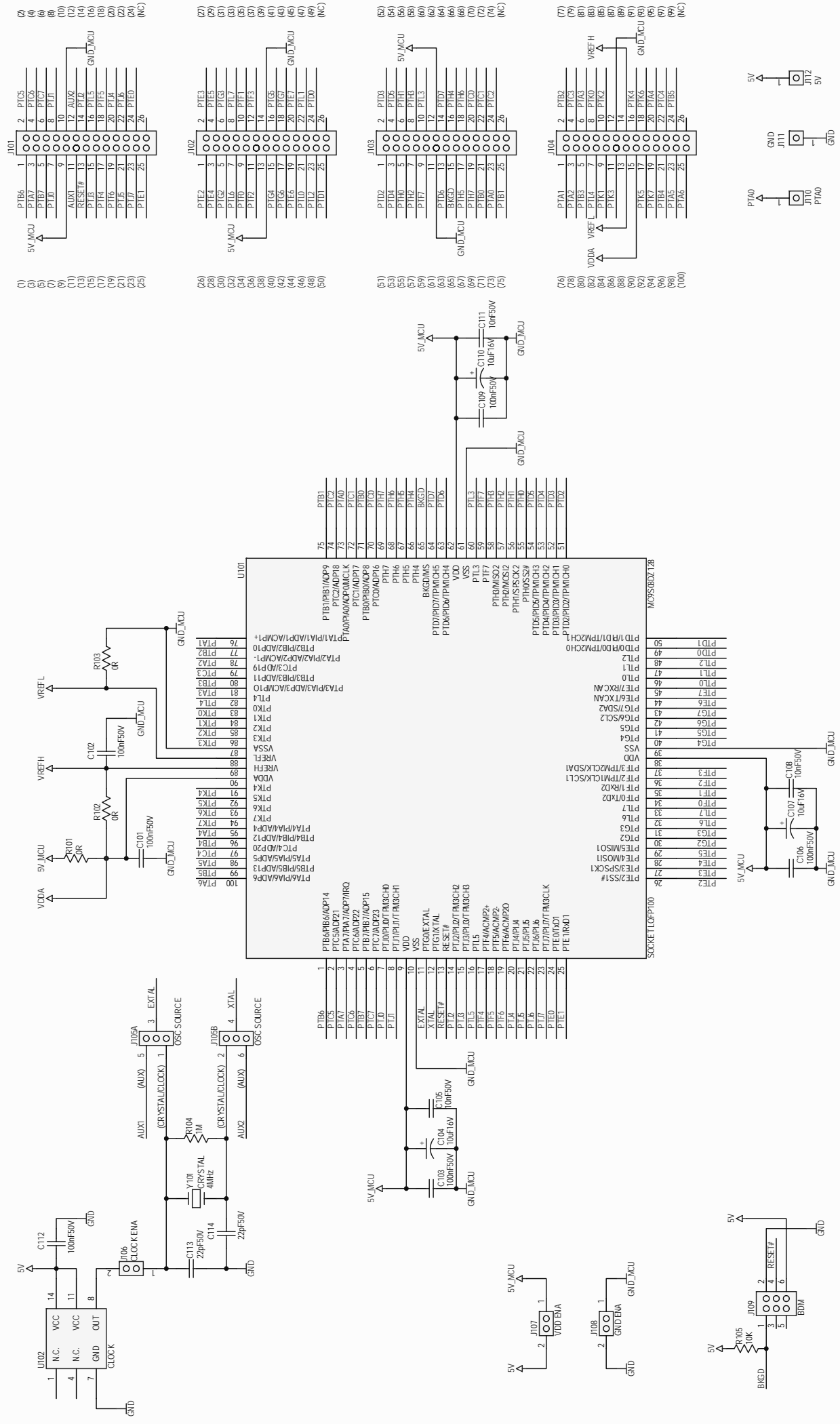

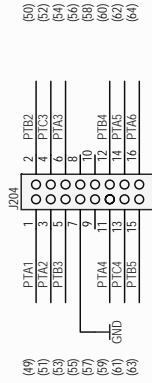
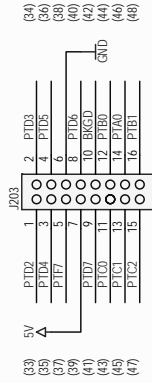
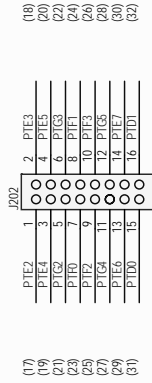
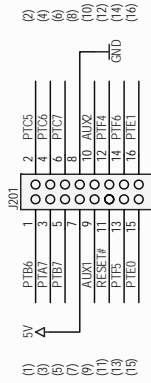

DB9S08D-100LQFP Bill of Material

Qty	Description	Ref. Designators	Vendor Part#
Capacitors			
6	Ceramic Capacitor 100nF X7R 50V 0805	C101, C102, C103, C106, C109, C112	Walsin, 0805B104K500CT
3	Ceramic Capacitor 10nF X7R 50V 0805	C105, C108, C111	Walsin, 0805B103K500CT
2	Ceramic Capacitor 22pF NP0 50V 0805	C113, C114	Walsin, 0805N220K500CT
3	Tantalum Capacitor 10uF 16V size B	C104, C107, C110	NIC Components, NTC-T106M16TRBF
Connectors			
1	Box Header Connector 6 way male straight solder pitch 2,54mm	J109	Coxoc, 302A-06PGAS003
4	Header Connector 13x 2 pin male gold straight solder h=6mm SMD pitch 2,54mm	J101, J102, J103, J104	Samtec, TSM-113-01-L-DV-P-TR
3	Header Connector 2x1 pin male gold straight 6mm pitch 2,54mm	J106, J107, J108	Coxoc, 307A-040GASAA3
1	Header Connector 3x2 pin male gold straight 6mm pitch 2,54mm	J105	Coxoc, 307A-080GBSAA3
3	PCB Terminal Connector black hole size 1,32mm 1-pin	J110, J111, J112	William Hughes, 100-103
5	Shunt jumper 2,54mm totally insulated black pitch 2,54mm		Coxoc, 308A02PGBA003
4	Socket Connector 16-pin SMD h=7mm pitch 2,54mm	J201, J202, J203, J204	Samtec, SSM-108-L-DV-BE-K
Crystals			
1	SMD Crystal 4MHz HC-49USMD (11x5x3)	Y101	Megatec, HC49/USM4-004M000000CR
Resistors			
3	SMD Resistor 0R 5% 1/8W 0805	R101, R102, R103	Kamaya, RMC1/10JPTP
1	SMD Resistor 10K 1% 0805	R105	Kamaya, RMC1/10K1002FTP
1	SMD Resistor 1M 1% 0805	R104	Kamaya, RMC1/10K1004FTP
Sockets			
1	IC Socket Tulip pitch 2,54mm DIP14	U102	Preci-dip, 110-87-314-41-001101
1	ZIF IC Socket Open Top Wells-CTI QFP100	U101	Wells CTI, 7014-100-1-08