

## SUMMARY

### # Wires

Low	0
High	0
Coax	1
Triax	0
Quad	0
Fiber	0
Fluidic	0



*Image is for illustrative purpose only*

### Download

[Request a quote](#)

[Catalog](#)

Series	1E
Termination type	Male solder
IP rating	68
Cable Ø	2.10 - 2.50 mm
Matching parts	ERA.1E.250.CTL
Status	
Alternative part	

## TECHNICAL DETAILS

### Mechanics

Shell Style/Model	FFA*: Straight plug, cable collet and nut for fitting a bend relief
Keying	Circular (can rotate), plug has male contact(s)
Housing Material	Brass (chrome plated) shell and collet nut, nickel plated brass latch sleeve and mid pieces
Cable Fixing	C25: 2.1 - 2.5 mm
Variant	Z : Nut for fitting a bend relief

### Performance

Configuration	1E.250 : 1 Coax (50 Ohm)
Insulator	T: PTFE
Rated Current	12 Amps

### Specifications

Contact Type:	Coaxial 50 Ohm (Solder)
Max. Matings:	1000
Contact Dia.:	0.9 mm (0.035in)
Bucket Dia.:	1 mm (0.039in)
Vtest:	3000 V (AC), 4200 V (DC)
Impedance:	50 Ohm

VSWR:  $1.01 + 0.23 * f/\text{GHz}$

Cable type: RG 178 B/U, RG 196 A/U, RG 188 A/U, RG 316 B/U, RG 174 A/U, HF-2114, RG 122 /U

## Others

Endurance (Shell): 5000 mating cycles

Temp (min / max):  $-55^{\circ}\text{C} / +200^{\circ}\text{C}$

Humidity (max):  $\leq 95\%$  [at  $60^{\circ}\text{C} / 140^{\circ}\text{F}$ ]

Vibration: 15 g [10 Hz - 2000 Hz]

Shock Resistance: 100 g [ 6 ms]

Salt Spray Corrosion: >1000 hr

Climatical Category: 50/175/21

Shielding (min): 95 dB (10 MHz)

Shielding (min): 80 dB (1 GHz)

IP Rating: 68

---

## DRAWINGS

### Draws

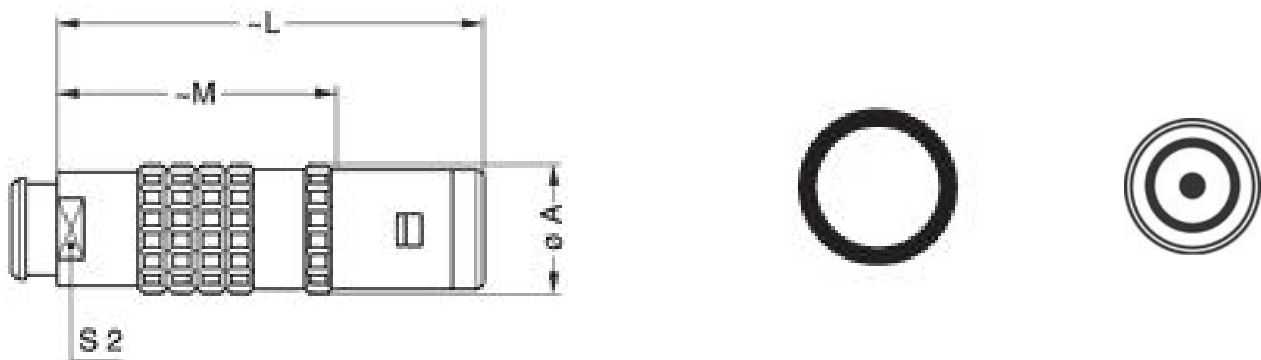

### Dimensions

	A	L	M	S2
mm.	13	42	28	9
in.	0,51	1,65	1,10	0,35

---

## RECOMMENDED BY LEMO

### Tools

Spanner wrench: DCD.1E.008.PA090

Caps: BFA.1E.100.NAS

