

SLOT & HOLE WILL CLEAR ORIENTATION PEG & MATING PIN HOUSING BLADES. PLATING NOT REQUIRED

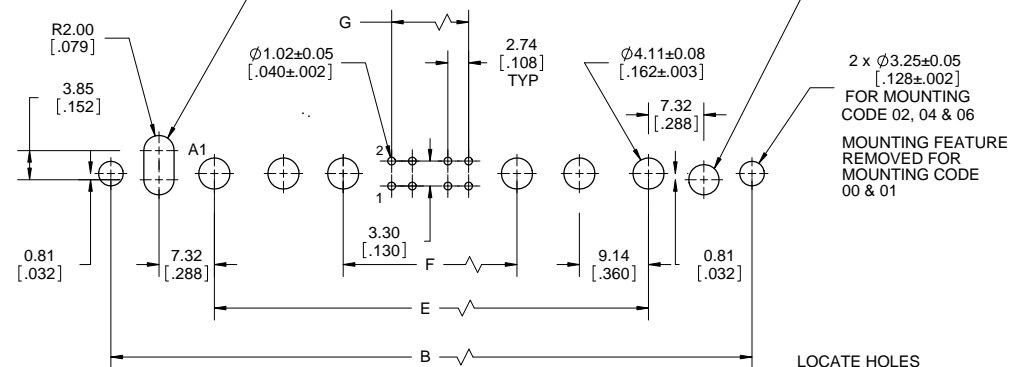

RECOMMENDED PCB LAYOUT
COMPONENT SIDE OF BOARD



REVISIONS			
REV	DESCRIPTION, ECN, EAR NO.	DATE	APP'D
B	SOCKET UPDATE	MAR21/12	S.M
C	UPDATE MOUNTING OPTIONS	JUL10/12	S.M
D	ADD UL FILE NO.	JUN14/13	S.M

PART NUMBER:

DWR - T X XX S - V X X X - 0X

SERIES

DWR

PRODUCT TYPE

T = SLIMDRAWER FINISHED CONNECTOR

NUMBER OF POWER CONTACT POSITIONS

2, 4, 6 OR 8

NUMBER OF SIGNAL CONTACT POSITIONS

00, 04, 06, 08, 10 ... 40

GENDER

S = SOCKET (FEMALE)

ORIENTATION

V = VERTICAL

CONTACT OPTIONS

2 = COOLBAND POWER SIZE CB8
3 = COOLBAND POWER SIZE CB10
STD SIGNAL

CONTACT TERMINATION

3 = PCB TAIL: POWER 3.75mm [.148"] DIA, 3.81mm [.150"] LONG
STD SIGNAL PCB TAIL

PLATING OPTIONS

2 = 0.38µm [15µ"] GOLD
3 = 0.76µm [30µ"] GOLD
6 = 5.08µm [200µ"] SILVER POWER, 0.38µm [15µ"] GOLD SIGNAL

MOUNTING OPTION

00 = NO MOUNTING FEATURE
01 = NO MOUNTING EARS
02 = 3.25mm [.128"] DIA THROUGH HOLE FOR MOUNTING OR GUIDE PIN
04 = #4-40 THREADED HOLE
06 = M3 THREADED HOLE

SPECIAL CONFIGURATIONS

MANY UNIQUE FEATURES ARE READILY AVAILABLE TO SUIT CUSTOMER REQUIREMENTS. CONTACT AUTHORIZED AMPHENOL REPRESENTATIVE FOR DETAILS.

NOTES:

- MATERIALS:** ALL MATERIALS ARE RoHS COMPLIANT PER EU DIRECTIVE 2011/65/EU AND AMENDMENTS.

 - HOUSING: HIGH TEMPERATURE RESISTANT NYLON, UL FLAMMABILITY RATING 94V-0, COLOUR BLACK
 - SIGNAL CONTACTS: PHOSPHOR BRONZE PLATED WITH GOLD OVER 1.27µm (50µ") NICKEL ON THE MATING AREA AND 2.54µm (100µ") MATTE TIN OVER NICKEL ON THE TAILS.
 - COOLBAND POWER CONTACTS: BERYLLIUM COPPER MATING GRID, COPPER ALLOY BALANCE, PLATED WITH GOLD OR SILVER OVER 1.27µm (50µ") NICKEL ON THE MATING GRID AND SILVER OVER NICKEL OR MATTE TIN BALANCE.
- WHEN MATED WITH PIN CONNECTOR DWR-TXXXP-VXXX-XX, THE ORDER OF MECHANICAL AND ELECTRICAL ENGAGEMENT IS A) HOUSING BLADES, B) HOUSING SHROUD, C) POWER CONTACTS AND D) SIGNAL CONTACTS.
- ELECTRICAL CHARACTERISTICS**

 - CURRENT RATING: UP TO 55A POWER, 4A SIGNAL
 - INSULATION RESISTANCE: 5000 MEGOHMS
 - DIELECTRIC WITHSTANDING VOLTAGE: 1500VDC
 - OPERATING TEMPERATURE: -55°C TO +105°C
- UL FILE NUMBER E64911

UNLESS SPECIFIED OTHERWISE	DRAWN	S.CAELERS	MAR17/11
PRIMARY UNITS MILLIMETERS	CHECKED	S.MUGAN	JUN17/11
SECONDARY INCHES	M.E. APP'D		
REFERENCE IN PARENTHESES	Q.A. APP'D		
GENERAL TOLERANCES	DWG APPR.		
1 DECIMAL PLACE	ENG. REL. NO.		
2 DECIMAL PLACES	REF.		
3 DECIMAL PLACES	THIRD ANGLE PROJECTION		
ANGULAR DEGREES	DO NOT SCALE DRAWING		

Amphenol Canada Corp.

DWR SERIES SLIM DRAWER SOCKET CONNECTOR, POWER & SIGNAL CONTACTS, VERTICAL PCB TAILS (Ø3.75mm [.148"] x 3.81mm [.150"] LONG), RoHS COMPLIANT

DWG. NO.	REV
P-DWR-TXXXS-VX3X-0X	D
CODE ID NO. 03554	DWG SIZE: C
SCALE: 2:1	SHEET 1 OF 2

Socket Connector Part Number	Number of Power Contacts	Number of Signal Contacts	"A" Overall Length		"B" Mounting Hole Centrelines		"C" Length Without Mounting Ears		"D" Socket Body Length		"E" Outside Power Centrelines		"F" Inside Power Centrelines		"G" Outside Signal Centrelines			
			mm	inch	mm	inch	mm	inch	mm	inch	mm	inch	mm	inch	mm	inch	mm	inch
DWR-T200S-VXXX-XX	2	0	47.70	1.878	36.53	1.438	29.75	1.171	23.98	0.944	9.14	0.360	9.14	0.360	---	---		
DWR-T204S-VXXX-XX	2	4	54.10	2.130	42.93	1.690	36.15	1.423	30.38	1.196	15.54	0.612	15.54	0.612	2.74	0.108		
DWR-T208S-VXXX-XX	2	8	59.59	2.346	48.41	1.906	41.63	1.639	35.86	1.412	21.03	0.828	21.03	0.828	8.23	0.324		
DWR-T212S-VXXX-XX	2	12	65.07	2.562	53.90	2.122	47.12	1.855	41.35	1.628	26.52	1.044	26.52	1.044	13.72	0.540		
DWR-T216S-VXXX-XX	2	16	70.56	2.778	59.39	2.338	52.61	2.071	46.84	1.844	32.00	1.260	32.00	1.260	19.20	0.756		
DWR-T220S-VXXX-XX	2	20	76.05	2.994	64.87	2.554	58.09	2.287	52.32	2.060	37.49	1.476	37.49	1.476	24.69	0.972		
DWR-T224S-VXXX-XX	2	24	81.53	3.210	70.36	2.770	63.58	2.503	57.81	2.276	42.98	1.692	42.98	1.692	30.18	1.188		
DWR-T228S-VXXX-XX	2	28	87.02	3.426	75.84	2.986	69.06	2.719	63.30	2.492	48.46	1.908	48.46	1.908	35.66	1.404		
DWR-T232S-VXXX-XX	2	32	92.51	3.642	81.33	3.202	74.55	2.935	68.78	2.708	53.95	2.124	53.95	2.124	41.15	1.620		
DWR-T236S-VXXX-XX	2	36	97.99	3.858	86.82	3.418	80.04	3.151	74.27	2.924	59.44	2.340	59.44	2.340	46.63	1.836		
DWR-T240S-VXXX-XX	2	40	103.48	4.074	92.30	3.634	85.52	3.367	79.76	3.140	64.92	2.556	64.92	2.556	52.12	2.052		
DWR-T400S-VXXX-XX	4	0	65.99	2.598	54.81	2.158	48.03	1.891	42.27	1.664	27.43	1.080	9.14	0.360	---	---		
DWR-T404S-VXXX-XX	4	4	72.39	2.850	61.21	2.410	54.43	2.143	48.67	1.916	33.83	1.332	15.54	0.612	2.74	0.108		
DWR-T408S-VXXX-XX	4	8	77.88	3.066	66.70	2.626	59.92	2.359	54.15	2.132	39.32	1.548	21.03	0.828	8.23	0.324		
DWR-T412S-VXXX-XX	4	12	83.36	3.282	72.19	2.842	65.41	2.575	59.64	2.348	44.81	1.764	26.52	1.044	13.72	0.540		
DWR-T416S-VXXX-XX	4	16	88.85	3.498	77.67	3.058	70.89	2.791	65.13	2.564	50.29	1.980	32.00	1.260	19.20	0.756		
DWR-T420S-VXXX-XX	4	20	94.34	3.714	83.16	3.274	76.38	3.007	70.61	2.780	55.78	2.196	37.49	1.476	24.69	0.972		
DWR-T424S-VXXX-XX	4	24	99.82	3.930	88.65	3.490	81.87	3.223	76.10	2.996	61.26	2.412	42.98	1.692	30.18	1.188		
DWR-T428S-VXXX-XX	4	28	105.31	4.146	94.13	3.706	87.35	3.439	81.58	3.212	66.75	2.628	48.46	1.908	35.66	1.404		
DWR-T432S-VXXX-XX	4	32	110.79	4.362	99.62	3.922	92.84	3.655	87.07	3.428	72.24	2.844	53.95	2.124	41.15	1.620		
DWR-T436S-VXXX-XX	4	36	116.28	4.578	105.11	4.138	98.33	3.871	92.56	3.644	77.72	3.060	59.44	2.340	46.63	1.836		
DWR-T440S-VXXX-XX	4	40	121.77	4.794	110.59	4.354	103.81	4.087	98.04	3.860	83.21	3.276	64.92	2.556	52.12	2.052		
DWR-T600S-VXXX-XX	6	0	84.28	3.318	73.10	2.878	66.32	2.611	60.55	2.384	45.72	1.800	9.14	0.360	---	---		
DWR-T604S-VXXX-XX	6	4	90.68	3.570	79.50	3.130	72.72	2.863	66.95	2.636	52.12	2.052	15.54	0.612	2.74	0.108		
DWR-T608S-VXXX-XX	6	8	96.16	3.786	84.99	3.346	78.21	3.079	72.44	2.852	57.61	2.268	21.03	0.828	8.23	0.324		
DWR-T612S-VXXX-XX	6	12	101.65	4.002	90.47	3.562	83.69	3.295	77.93	3.068	63.09	2.484	26.52	1.044	13.72	0.540		
DWR-T616S-VXXX-XX	6	16	107.14	4.218	95.96	3.778	89.18	3.511	83.41	3.284	68.58	2.700	32.00	1.260	19.20	0.756		
DWR-T620S-VXXX-XX	6	20	112.62	4.434	101.45	3.994	94.67	3.727	88.90	3.500	74.07	2.916	37.49	1.476	24.69	0.972		
DWR-T624S-VXXX-XX	6	24	118.11	4.650	106.93	4.210	100.15	3.943	94.39	3.716	79.55	3.132	42.98	1.692	30.18	1.188		
DWR-T628S-VXXX-XX	6	28	123.60	4.866	112.42	4.426	105.64	4.159	99.87	3.932	85.04	3.348	48.46	1.908	35.66	1.404		
DWR-T632S-VXXX-XX	6	32	129.08	5.082	117.91	4.642	111.13	4.375	105.36	4.148	90.53	3.564	53.95	2.124	41.15	1.620		
DWR-T636S-VXXX-XX	6	36	134.57	5.298	123.39	4.858	116.61	4.591	110.85	4.364	96.01	3.780	59.44	2.340	46.63	1.836		
DWR-T640S-VXXX-XX	6	40	140.06	5.514	128.88	5.074	122.10	4.807	116.33	4.580	101.50	3.996	64.92	2.556	52.12	2.052		
DWR-T800S-VXXX-XX	8	0	102.57	4.038	91.39	3.598	84.61	3.331	78.84	3.104	64.01	2.520	9.14	0.360	---	---		
DWR-T804S-VXXX-XX	8	4	108.97	4.290	97.79	3.850	91.01	3.583	85.24	3.356	70.41	2.772	15.54	0.612	2.74	0.108		
DWR-T808S-VXXX-XX	8	8	114.45	4.506	103.28	4.066	96.50	3.799	90.73	3.572	75.90	2.988	21.03	0.828	8.23	0.324		
DWR-T812S-VXXX-XX	8	12	119.94	4.722	108.76	4.282	101.98	4.015	96.22	3.788	81.38	3.204	26.52	1.044	13.72	0.540		
DWR-T816S-VXXX-XX	8	16	125.43	4.938	114.25	4.498	107.47	4.231	101.70	4.004	86.87	3.420	32.00	1.260	19.20	0.756		
DWR-T820S-VXXX-XX	8	20	130.91	5.154	119.74	4.714	112.96	4.447	107.19	4.220	92.35	3.636	37.49	1.476	24.69	0.972		
DWR-T824S-VXXX-XX	8	24	136.40	5.370	125.22	4.930	118.44	4.663	112.67	4.436	97.84	3.852	42.98	1.692	30.18	1.188		
DWR-T828S-VXXX-XX	8	28	141.88	5.586	130.71	5.146	123.93	4.879	118.16	4.652	103.33	4.068	48.46	1.908	35.66	1.404		
DWR-T832S-VXXX-XX	8	32	147.37	5.802	136.19	5.362	129.41	5.095	123.65	4.868	108.81	4.284	53.95	2.124	41.15	1.620		
DWR-T836S-VXXX-XX	8	36	152.86	6.018	141.68	5.578	134.90	5.311	129.13	5.084	114.30	4.500	59.44	2.340	46.63	1.836		
DWR-T840S-VXXX-XX	8	40	158.34	6.234	147.17	5.794	140.39	5.527	134.62	5.300	119.79	4.716	64.92	2.556	52.12	2.052		

REVISIONS			
REV	DESCRIPTION, ECN, EAR NO.	DATE	APP'D
B	SOCKET UPDATE	JAN23/12	S.M
C	UPDATE MOUNTING OPTIONS	JUL10/12	S.M
D	ADD UL FILE NO.	JUN14/13	S.M

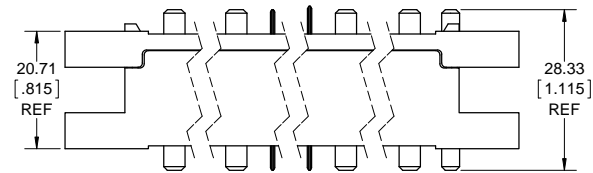

PIN AND SOCKET MATED ASSEMBLY

MOUNTING OPTIONS

MOUNTING CODE: 00

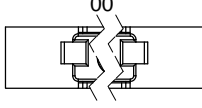

MOUNTING CODE: 01

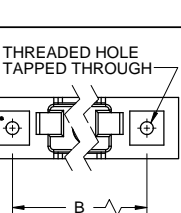
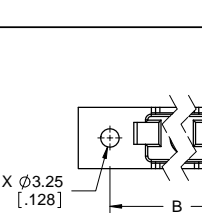
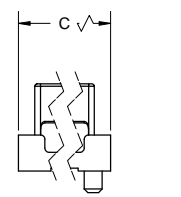
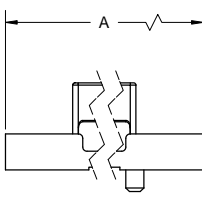
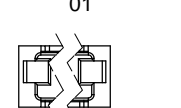

MOUNTING CODE: 02

MOUNTING CODE: 04, 06

FOR INTERMEDIATE CONFIGURATIONS (NUMBER OF SIGNAL CONTACTS = 06, 10, 14 ...) DIMENSIONS CAN BE CALCULATED BY AVERAGING VALUES IMMEDIATELY BEFORE AND AFTER. FOR EXAMPLE, DIMENSIONS OF DWR-T206S-VXXX-XX CAN BE OBTAINED BY AVERAGING VALUES CORRESPONDING TO DWR-T204S-VXXX-XX AND DWR-T208S-VXXX-XX.

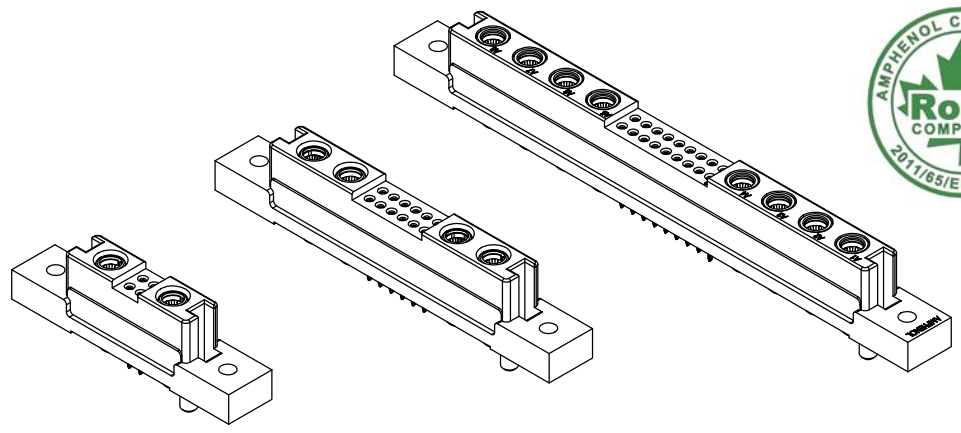

UNLESS SPECIFIED OTHERWISE	DRAWN	S.CAELERS	MAR17/11
PRIMARY UNITS MILLIMETERS	CHECKED	S.MUGAN	JUN17/11
SECONDARY INCHES	M.E. APP'D		
REFERENCE IN PARENTHESES	Q.A. APP'D		
GENERAL TOLERANCES	DWG APPR.		
1 DECIMAL PLACE	ENG. REL. NO.		
2 DECIMAL PLACES	REF.		
3 DECIMAL PLACES	THIRD ANGLE PROJECTION	DO NOT SCALE DRAWING	
ANGULAR DEGREES			

Amphenol Canada Corp.

DWR SERIES SLIM DRAWER SOCKET CONNECTOR, POWER & SIGNAL CONTACTS, VERTICAL PCB TAILS (Ø3.75mm [.148"] x 3.81mm [.150"] LONG), RoHS COMPLIANT

DWG. NO. **P-DWR-TXXXS-VX3X-0X** REV **D**

CODE ID NO. 03554 DWG SIZE: C SCALE: 2:1 SHEET 2 OF 2