

### SMD ▪ PLCC EAHE2835WD03



#### Features

- PLCC-2 package
- Top view white LED
- High luminous intensity output
- Wide viewing angle
- Pb-free
- RoHS compliant
- ANSI Binning

#### Description

The Everlight EAHE2835WD03 package has high efficacy, high CRI, low power consumption, wide viewing angle and a compact form factor. These features make this package an ideal LED for all lighting applications.

#### Applications

- General lighting
- Decorative and Entertainment Lighting
- Indicators
- Illumination
- Switch lights

## Mass Production List

Product	CRI Min. <sup>(1)</sup>	CCT(K)	Φ(lm) Min. <sup>(2)</sup>	Φ(lm) Max. <sup>(2)</sup>
EAHE2835WD03	80	2700K	27	37

Notes:

1. Tolerance of Color Rendering Index:  $\pm 2$
2. Tolerance of Luminous flux:  $\pm 11\%$ .

## Device Selection Guide

Chip Materials	Emitted Color	Resin Color
InGaN	Cool White Neutral White Warm White	Water Clear

## Absolute Maximum Ratings (T<sub>Soldering</sub>=25°C)

Parameter	Symbol	Rating	Unit
Forward Current	I <sub>F</sub>	180	mA
Peak Forward Current (Duty 1/10 @10ms)	I <sub>FP</sub>	300	mA
Power Dissipation	P <sub>d</sub>	580	mW
Operating Temperature	T <sub>opr</sub>	-40 ~ +85	°C
Storage Temperature	T <sub>stg</sub>	-40 ~ +100	°C
Thermal Resistance (Junction / Soldering point)	R <sub>th J-S</sub>	30	°C/W
Junction Temperature	T <sub>j</sub>	115	°C
Soldering Temperature	T <sub>sol</sub>	Reflow Soldering : 260 °C for 10 sec. Hand Soldering : 350 °C for 3 sec.	

Note:

The products are sensitive to static electricity and must be carefully taken when handling products

## Electro-Optical Characteristics (T<sub>Soldering</sub>=25°C)

Parameter	Symbol	Min.	Typ.	Max.	Unit	Condition
Luminous Flux <sub>(1)</sub>	Φ	27	-----	40	lm	I <sub>F</sub> =65mA
Forward Voltage <sub>(2)</sub>	V <sub>F</sub>	2.5	-----	3.2	V	I <sub>F</sub> =65mA
Color Rendering Index <sub>(3)</sub>	Ra	80	-----	-----		I <sub>F</sub> =65mA
Efficacy <sub>(1) (4)</sub>	-----	-----	180	-----	lm/W	I <sub>F</sub> =65mA
Viewing Angle	2θ <sub>1/2</sub>	-----	120	-----	deg	I <sub>F</sub> =65mA
Reverse Current	I <sub>R</sub>	-----	-----	50	μA	V <sub>R</sub> =5V

Notes:

1. Tolerance of Luminous flux: ±11%.
2. Tolerance of Forward Voltage: ±0.1V.
3. Tolerance of Color Rendering Index: ±2
4. Efficacy characteristics under the condition of 65mA and 5000K .

## Bin Range of Luminous Flux

### 2700K----

Bin Code	Min.	Max.	Unit	Condition
T1	27	29	lm	I <sub>F</sub> =65mA
T2	29	31		
T3	31	33		
T4	33	35		
T5	35	37		

### 3000K----

Bin Code	Min.	Max.	Unit	Condition
T1	28	30	lm	I <sub>F</sub> =65mA
T2	30	32		
T3	32	34		
T4	34	36		
T5	36	38		

### 4000K----

Bin Code	Min.	Max.	Unit	Condition
T1	29	31	lm	I <sub>F</sub> =65mA
T2	31	33		
T3	33	35		
T4	35	37		
T5	37	39		

**5000K---**

Bin Code	Min.	Max.	Unit	Condition
T1	30	32	lm	I <sub>F</sub> =65mA
T2	32	34		
T3	34	36		
T4	36	38		
T5	38	40		

**5700K---**

Bin Code	Min.	Max.	Unit	Condition
T1	30	32	lm	I <sub>F</sub> =65mA
T2	32	34		
T3	34	36		
T4	36	38		
T5	38	40		

**6500K---**

Bin Code	Min.	Max.	Unit	Condition
T1	29	31	lm	I <sub>F</sub> =65mA
T2	31	33		
T3	33	35		
T4	35	37		
T5	37	39		

Notes:  
Tolerance of Luminous flux: ±11%

### Bin Range of Forward Voltage

Group	Bin Code	Min.	Max.	Unit	Condition
2532	32	2.5	2.6	V	$I_F=65\text{mA}$
	33	2.6	2.7		
	34	2.7	2.8		
	35	2.8	2.9		
	36	2.9	3.0		
	37	3.0	3.1		
	38	3.1	3.2		

Note:

Tolerance of Forward Voltage:  $\pm 0.1\text{V}$ .

**Bin Code of Macadam 3 step and 5 step**

Step	CCT	Cx	Cy	a	b	theta
3	2700	0.4583	0.4104	0.00810	0.00420	49.70
	3000	0.4345	0.4033	0.00834	0.00408	50.22
	3500	0.4080	0.3919	0.00927	0.00414	51.00
	4000	0.3827	0.3803	0.00939	0.00402	54.80
	5000	0.3451	0.3559	0.00822	0.00354	64.12
	5700	0.3293	0.3423	0.00747	0.00321	66.51
	6500	0.3131	0.3290	0.00669	0.00285	64.57

### The C.I.E. 1931 Chromaticity Diagram

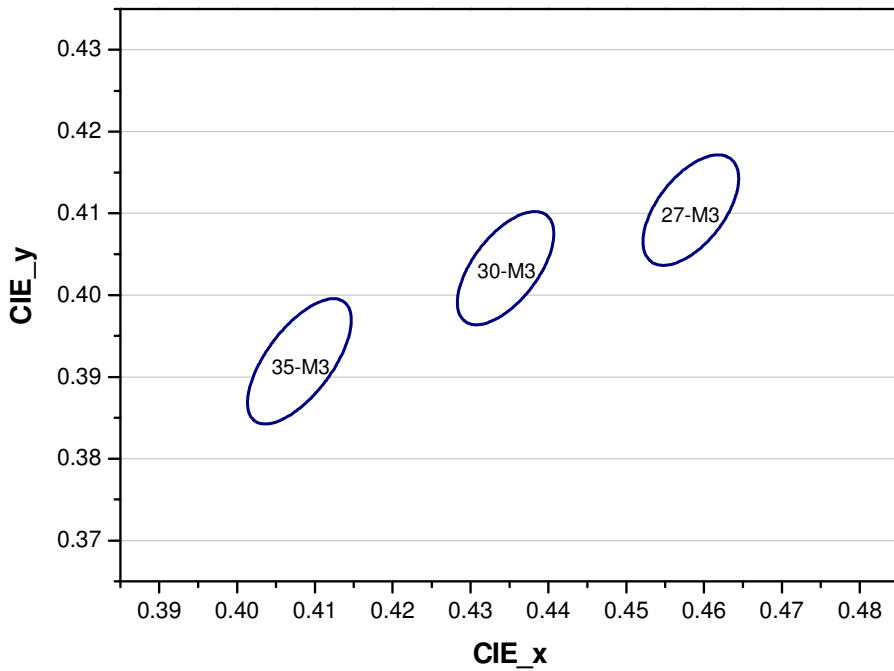

### The C.I.E. 1931 Chromaticity Diagram

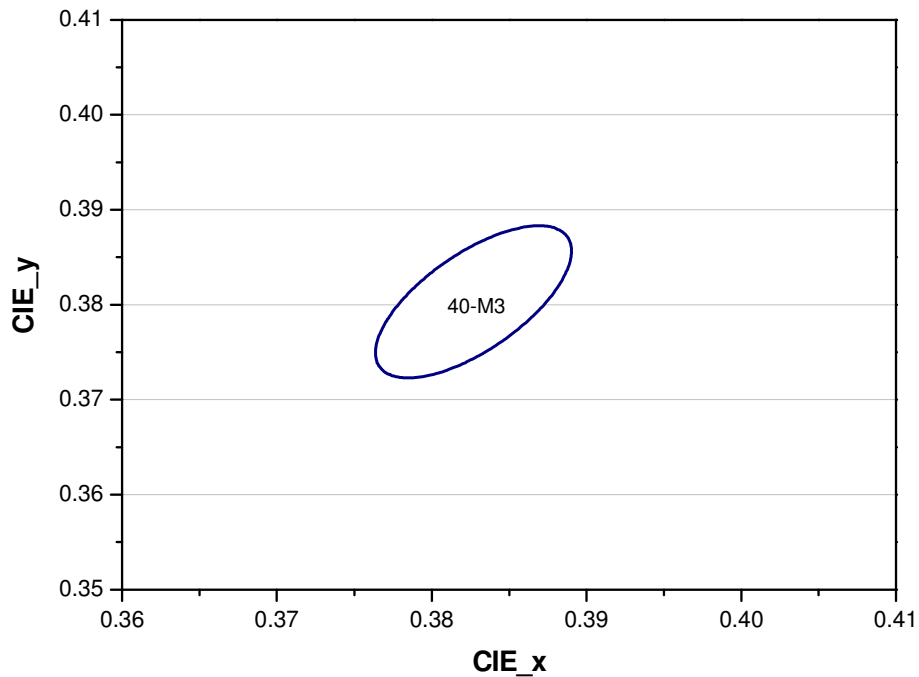



### The C.I.E. 1931 Chromaticity Diagram

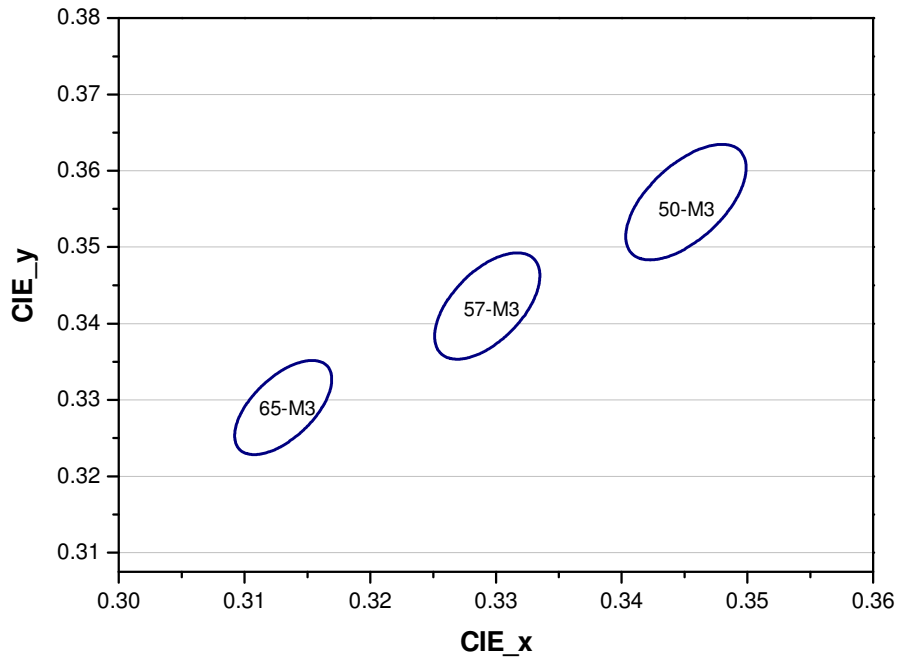

Note:

1. The value is based on driving current by 65mA.
2. Tolerance of Chromaticity Coordinates:  $\pm 0.01$ .

## Spectrum Distribution

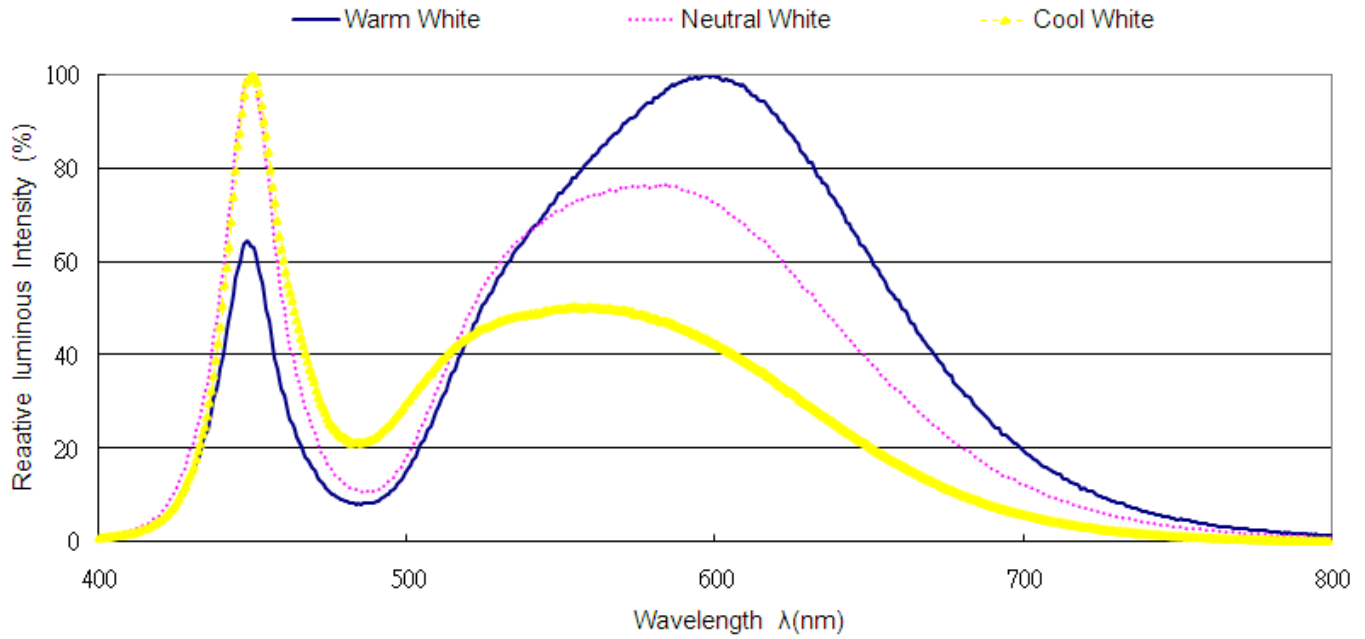

## Typical Electro-Optical Characteristics Curves

**Fig.1 – Forward Voltage Shift vs. Junction Temperature**

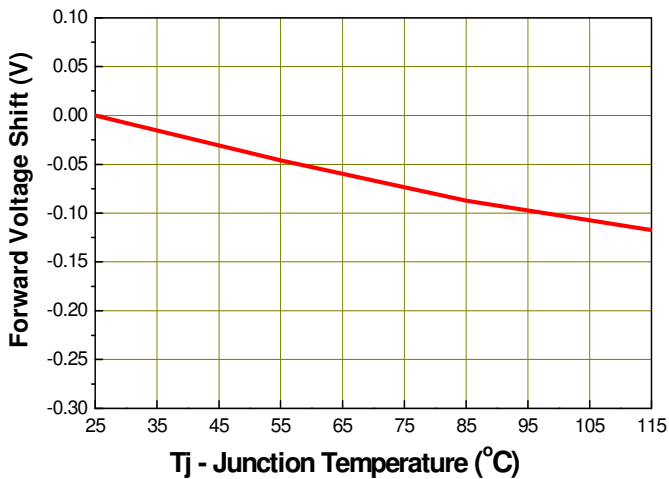

**Fig.2 - Relative Luminous Intensity vs. Forward Current**

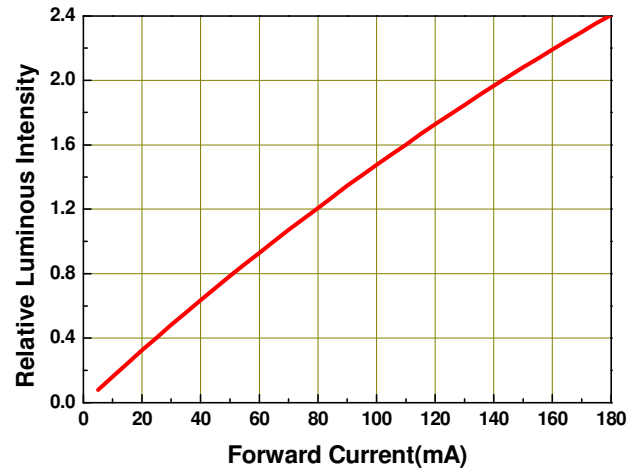

Typical Electro-Optical Characteristics Curves

Fig.3 - Relative Luminous Intensity vs. Junction Temperature

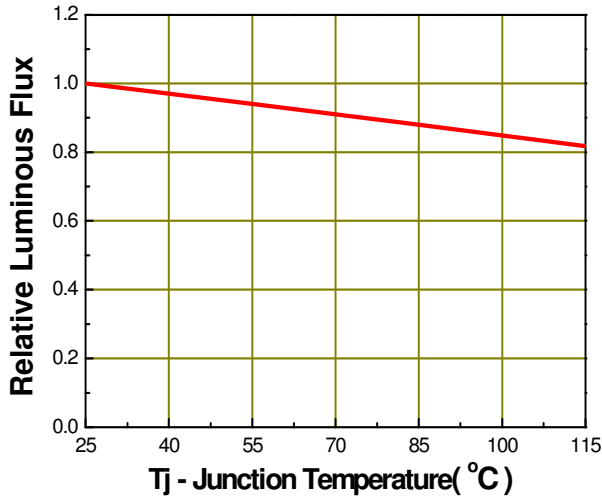

Fig.4 - Forward Current vs. Forward Voltage

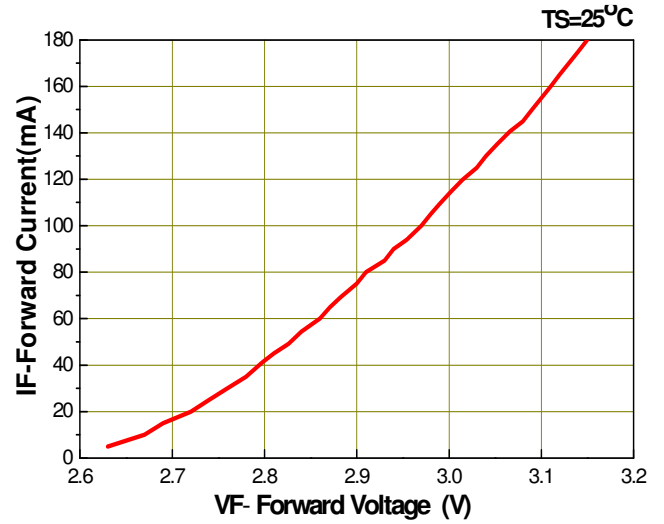

Fig.5 – Max. Driving Forward Current vs. Soldering Temperature

$R_{th\ j-s}=30\ ^\circ\text{C/W}$

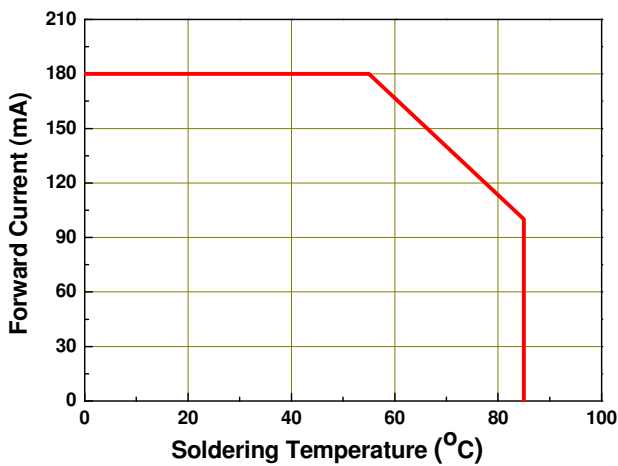
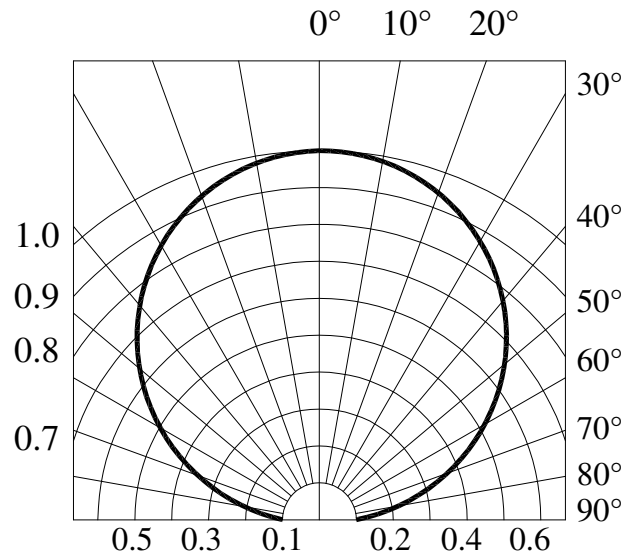
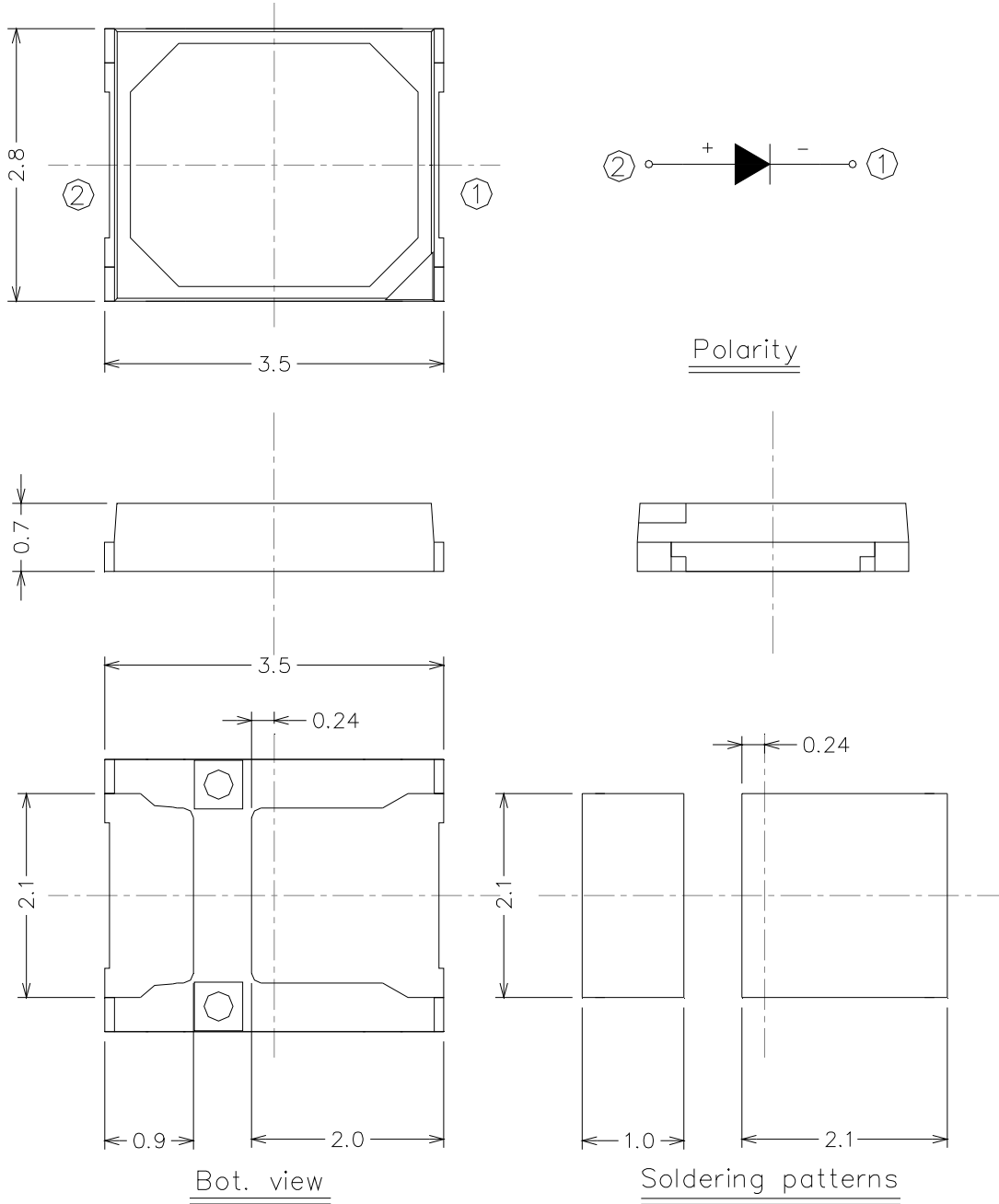

Fig.6 – Radiation Diagram



### Package Dimension



Note:  
Tolerance unless mentioned is  $\pm 0.15\text{mm}$ ; Unit = mm

## Moisture Resistant Packing Materials

### Label Explanation

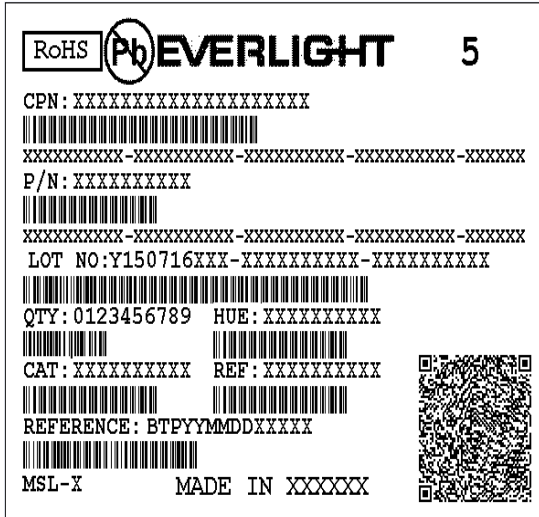

- CPN: Customer's Product Number
- P/N: Product Number
- QTY: Packing Quantity
- CAT: Luminous Intensity Rank
- HUE: Dom. Wavelength Rank
- REF: Forward Voltage Rank
- LOT No: Lot Number

### Reel Dimensions

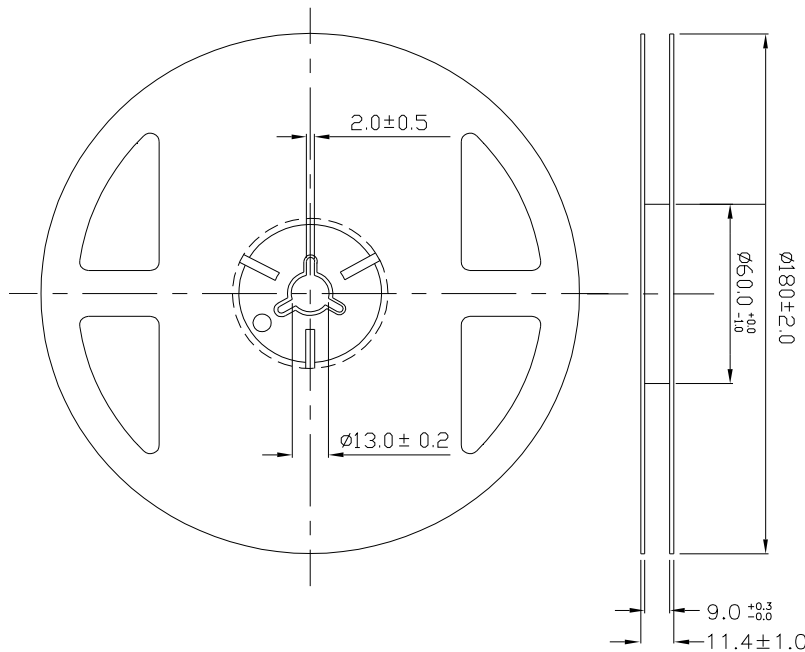

Note:  
Tolerances unless mentioned  $\pm 0.1$  mm. Unit = mm

**Carrier Tape Dimensions: Loaded Quantity 2000 pcs Per Reel**

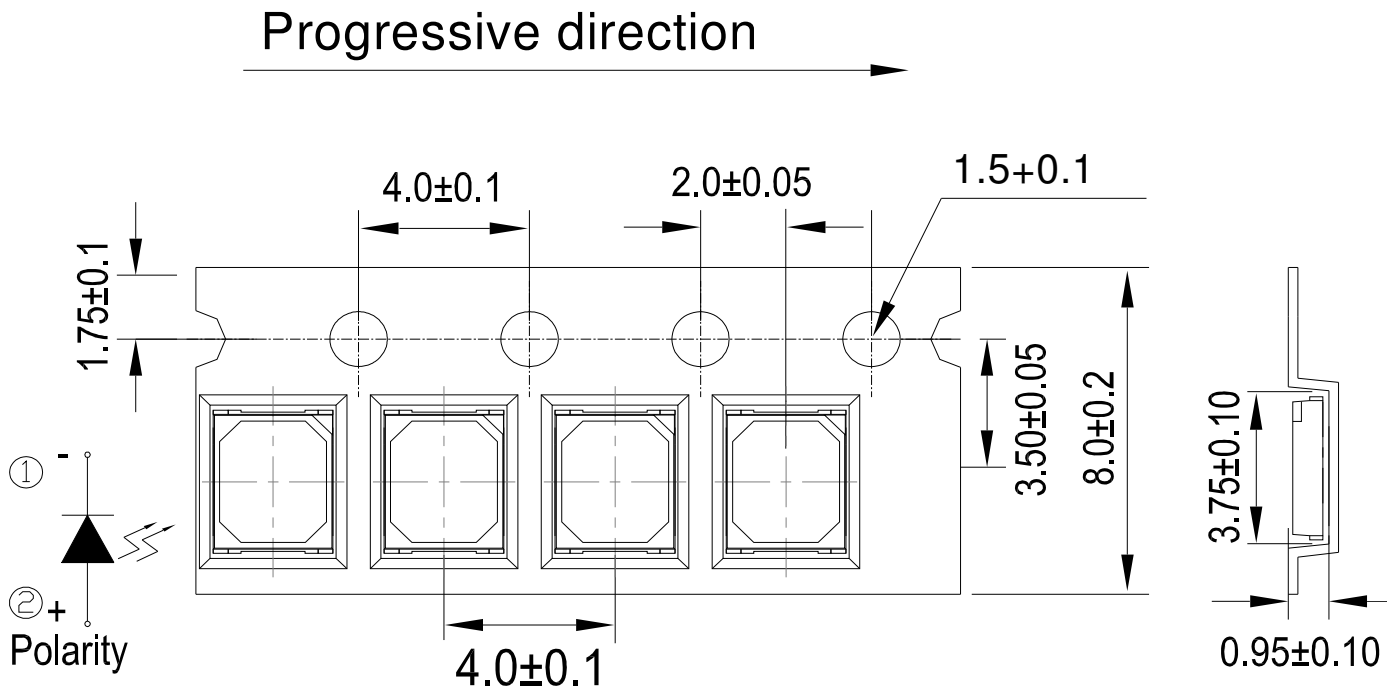

Note:  
1. Tolerance unless mentioned is  $\pm 0.1$ mm; Unit = mm

**Moisture Resistant Packing Process**

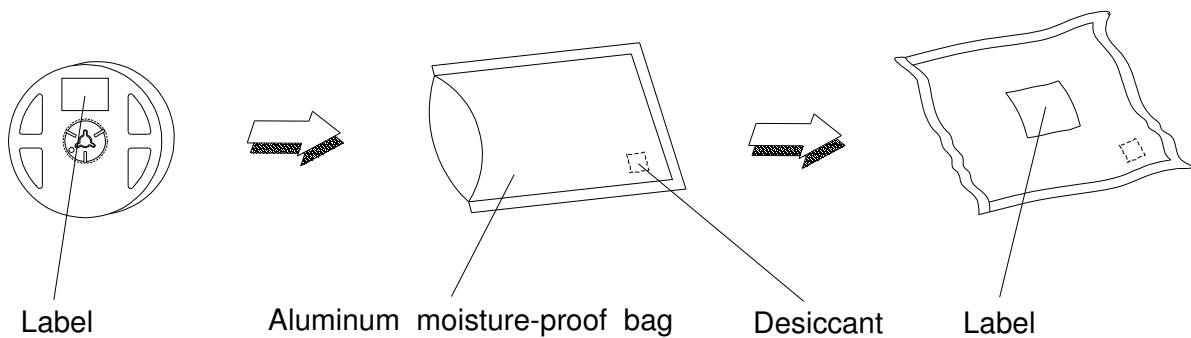

## Reliability Test Items and Conditions

The reliability of products shall be satisfied with items listed below.  
Confidence level : 90%  
LTPD : 10%

No.	Items	Test Condition	Test Hours/Cycles	Sample Size	Ac/Re
1	Reflow Soldering	Temp. : 260°C/10sec.	6 Min.	22 PCS.	0/1
2	Thermal Shock	H : +100°C 20min ∫ 10 sec L : -10°C 20min	200 Cycles	22 PCS.	0/1
3	Temperature Cycle	H : +100°C 30min ∫ 5 min L : -40°C 30min	200 Cycles	22 PCS.	0/1
4	High Temperature/Humidity Reverse Bias	Ta=85°C,85%RH	1000 Hrs.	22 PCS.	0/1
5	High Temperature/Humidity Operation	Ta=85°C,85%RH, I <sub>F</sub> = 100 mA	1000 Hrs.	22 PCS.	0/1
6	Low Temperature Storage	Ta=-40°C	1000 Hrs.	22 PCS.	0/1
7	High Temperature Storage	Ta=85°C	1000 Hrs.	22 PCS.	0/1
8	Low Temperature Operation Life	Ta=-40°C, I <sub>F</sub> = 180 mA	1000 Hrs.	22 PCS.	0/1
9	High Temperature Operation/ Life#1	Ta=25°C, I <sub>F</sub> = 180 mA	1000 Hrs.	22 PCS.	0/1
10	High Temperature Operation/ Life#2	Ta=55°C, I <sub>F</sub> =180 mA	1000 Hrs.	22 PCS.	0/1
11	High Temperature Operation/ Life#3	Ta=85°C, I <sub>F</sub> = 100 mA	1000 Hrs.	22 PCS.	0/1

## Precautions for Use

### 1. Over-current-proof

Customer must apply resistors for protection; otherwise slight voltage shift will cause big current change (Burn out will happen).

### 2. Storage

2.1 Do not open moisture proof bag before the products are ready to use.

2.2 Before opening the package: The LEDs should be kept at 30°C or less and 90%RH or less.

2.3 After opening the package: The LED's floor life is 168 Hrs under 30°C or less and 60% RH or less. If unused LEDs remain, it should be stored in moisture proof packages.

2.4 If the moisture absorbent material (silica gel) has faded away or the LEDs have exceeded the storage time, baking treatment should be performed using the following conditions.

Baking treatment: 60±5°C for 24 hours.

### 3. Soldering Condition

#### 3.1 Pb-free solder temperature profile

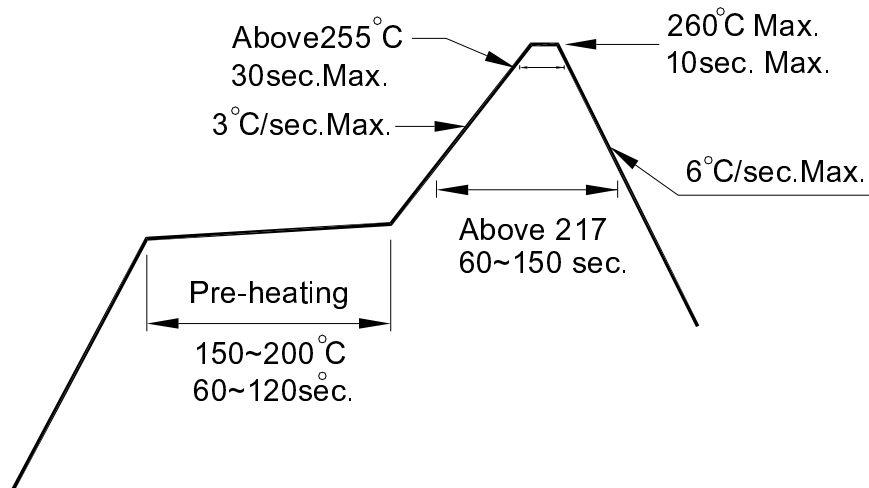

3.2 Reflow soldering should not be done more than two times.

3.3 When soldering, do not put stress on the LEDs during heating.

3.4 After soldering, do not warp the circuit board.

## 4. Soldering Iron



Each terminal is to go to the tip of soldering iron temperature less than 350°C for 3 seconds within once in less than the soldering iron capacity 25W. Leave two seconds and more intervals, and do soldering of each terminal. Be careful because the damage of the product is often started at the time of the hand solder.

5. Repairing

Repair should not be done after the LEDs have been soldered. When repairing is unavoidable, a double-head soldering iron should be used (as below figure). It should be confirmed beforehand whether the characteristics of the LEDs will or will not be damaged by repairing.

