

| CKT. SIZE | OPTION A (WITHOUT RIBS) |            | OPTION B (WITH RIBS) |            | DIMENSION        |                  |
|-----------|-------------------------|------------|----------------------|------------|------------------|------------------|
|           | EDP. NO.                | ENG. NO.   | EDP. NO.             | ENG. NO.   | A                | B                |
|           | 4                       | NOT TOOLED | X-70013-0008         | NOT TOOLED | X-70013-1004     | (5.33)<br>.210   |
| 6         | 015-04-5061             | 70013-0001 | 015-04-5064          | 70013-1006 | (7.87)<br>.310   | (5.08)<br>.200   |
| 8         | 015-04-5081             | 70013-0007 | 015-04-5084          | 70013-1008 | (10.41)<br>.410  | (7.62)<br>.300   |
| 10        | 015-04-5101             | 70013-0002 | 015-04-5104          | 70013-1010 | (12.95)<br>.510  | (10.16)<br>.400  |
| 12        | 015-04-5121             | 70013-0012 | 015-04-5124          | 70013-1012 | (15.49)<br>.610  | (12.70)<br>.500  |
| 14        | 015-04-5141             | 70013-0014 | 015-04-5144          | 70013-1014 | (18.03)<br>.710  | (15.24)<br>.600  |
| 16        | 015-04-5161             | 70013-0016 | 015-04-5164          | 70013-1016 | (20.57)<br>.810  | (17.78)<br>.700  |
| 18        | 015-04-5181             | 70013-0018 | 015-04-5184          | 70013-1018 | (23.11)<br>.910  | (20.32)<br>.800  |
| 20        | 015-04-5201             | 70013-0003 | 015-04-5204          | 70013-1020 | (25.65)<br>1.010 | (22.86)<br>.900  |
| 22        | 015-04-5221             | 70013-0022 | 015-04-5224          | 70013-1022 | (28.19)<br>1.110 | (25.40)<br>1.000 |
| 24        | 015-04-5241             | 70013-0024 | 015-04-5244          | 70013-1024 | (30.73)<br>1.210 | (27.94)<br>1.100 |
| 26        | 015-04-5261             | 70013-0026 | 015-04-5264          | 70013-1026 | (33.27)<br>1.310 | (30.48)<br>1.200 |
| 28        | 015-04-5281             | 70013-0028 | 015-04-5284          | 70013-1028 | (35.81)<br>1.410 | (33.02)<br>1.300 |
| 30        | 015-04-5301             | 70013-0004 | 015-04-5304          | 70013-1030 | (38.35)<br>1.510 | (35.56)<br>1.400 |
| 32        | 015-04-5321             | 70013-0032 | 015-04-5324          | 70013-1032 | (40.89)<br>1.610 | (38.10)<br>1.500 |
| 34        | 015-04-5341             | 70013-0034 | 015-04-5344          | 70013-1034 | (43.43)<br>1.710 | (40.64)<br>1.600 |
| 36        | 015-04-5361             | 70013-0036 | 015-04-5364          | 70013-1036 | (45.97)<br>1.810 | (43.18)<br>1.700 |
| 38        | 015-04-5381             | 70013-0038 | 015-04-5384          | 70013-1038 | (48.51)<br>1.910 | (45.72)<br>1.800 |
| 40        | 015-04-5401             | 70013-0005 | 015-04-5404          | 70013-1040 | (51.05)<br>2.010 | (48.26)<br>1.900 |
| 42        | 015-04-5421             | 70013-0042 | 015-04-5424          | 70013-1042 | (53.59)<br>2.110 | (50.80)<br>2.000 |
| 44        | 015-04-5441             | 70013-0044 | 015-04-5444          | 70013-1044 | (56.13)<br>2.210 | (53.34)<br>2.100 |
| 46        | 015-04-5461             | 70013-0046 | 015-04-5464          | 70013-1046 | (58.67)<br>2.310 | (55.88)<br>2.200 |
| 48        | 015-04-5481             | 70013-0048 | 015-04-5484          | 70013-1048 | (61.21)<br>2.410 | (58.42)<br>2.300 |
| 50        | 015-04-5501             | 70013-0006 | 015-04-5504          | 70013-1050 | (63.75)<br>2.510 | (60.96)<br>2.400 |

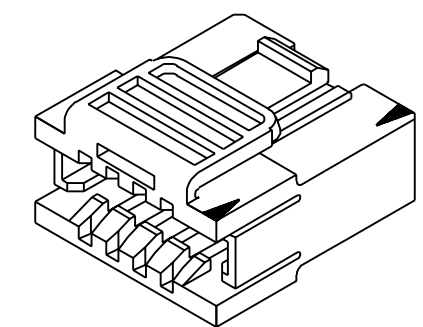
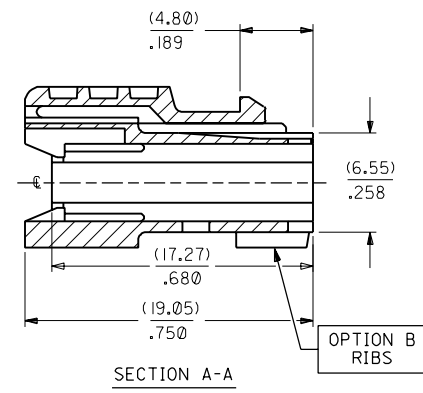
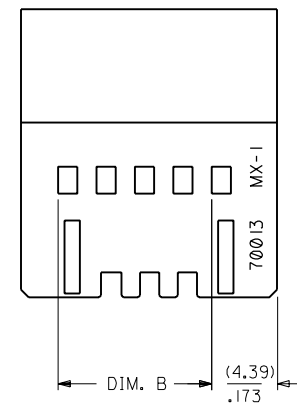
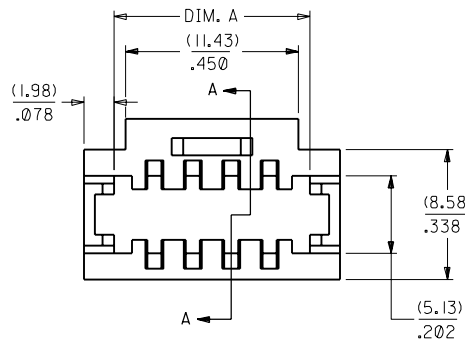
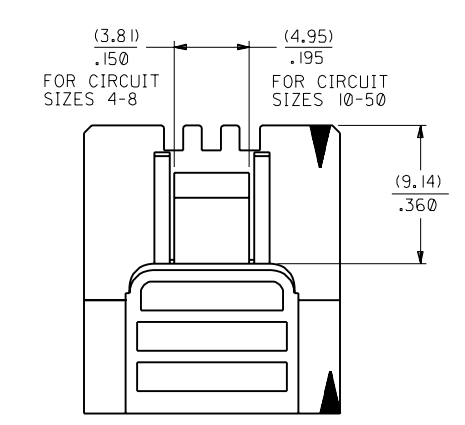
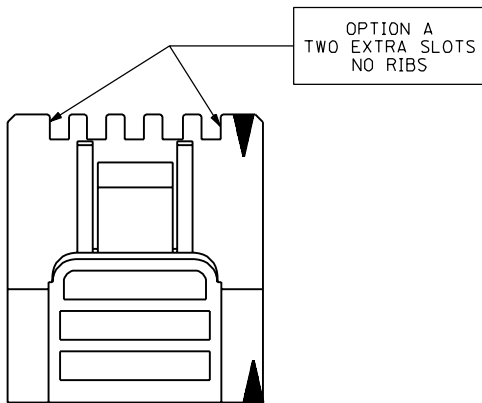

- NOTES:
- 1) MATERIAL: GLASS FILLED POLYESTER, 94V-0, BLACK
  - 2) MOLD TO BE EXPANDABLE FOR CIRCUIT SIZES LISTED ON CHART.
  - 3) 10 CIRCUIT, B OPTION PART SHOWN.
  - 4) OPTION "A" - MATES WITH HEADERS 8723-B, 8723-C, 8724-B, 8724-C, 70227, 70229, AND 70022. OPTION "B" - MATES WITH HEADERS 8723-C, 8724-C, 70227, 700229, AND 70022 (EXCEPT THE 50 CIRCUIT PARTS LISTED ON PAGE 4. SEE THE CHART ON PAGE 4 FOR MATING INTERIM CLIPS)
  - 5) ALL DIMENSIONS FOR REFERENCE ONLY.
  - 6) OPTIONAL SPRING CLIP FOR GREATER RETENTION OF MODULES IS RECOMMENDED FOR CIRCUIT SIZES 18-50. PART NUMBER 71809.
  - 7) PACKAGE PER PK-70013-100.

|   |    |
|---|----|
| 4 | L2 |
| 3 | L1 |
| 2 | L3 |
| 1 | M  |

MFG, SH, REV.

|      |  |      |   |  |  |                           |
|------|--|------|---|--|--|---------------------------|
| M    | ADD PKG NOTE<br>ECN UDT2000-0468<br>SCHAFFER 99/12/1 | LI   | REVISE PER<br>ECR #U80583<br>10/10/97 HPA                                   | DIMENSIONS SHOWN (METRIC) INCH<br>UNLESS OTHERWISE SPECIFIED<br>TOLERANCES: ANGULAR ± 1/2°                             | ▽ = 0 ▼ = 0  | REVISE ONLY ON CAD SYSTEM |
| L3   | CLEAN UP DWG<br>PER UDT1999-0522<br>99/01/05 KAS     | L    | REVISE PER<br>ECR #U80062<br>3/1/88 MJM                                     | INCH METRIC<br>5 PLACE ± .010 ---<br>2 PLACE ± .015 ± 0.25<br>1 PLACE --- ± 0.38                                       | TITLE<br>DUAL ROW<br>INTERIM CLIP<br>.100 GRID     |                           |
| L2   | REVISE PER<br>ECR #UDT1998-0206<br>98/01/09 HPA      | K    | REVISE TOP WALL &<br>ANTI-FISH HOOK<br>RIBS PER ECR#9622<br>1/17/87 MJM/JAS | DRAFT WHERE APPLICABLE MUST<br>REMAIN WITHIN DIMENSIONS  | SHEET NO. DATE<br>1 OF 4 06/23/86                  |                           |
| LTR. | REVISIONS  | LTR. | REVISIONS   | DRWG. NO.<br>BY: DJB CHK'D BY: DB<br>APP'D BY: WZ SCALE: 4:1   | PART NO. DRWG. NO.<br>SEE CHART SD-70013-0001-1050 |                           |
|      |  |      |   | THIS DRAWING CONTAINS INFORMATION THAT IS PROPRIETARY TO MOLEX INC. AND SHOULD NOT BE USED WITHOUT WRITTEN PERMISSION. |  |                           |

4 CKT.

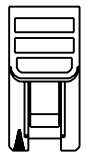

6 CKT.  
3 CKT. DUAL  
ROW - ODD

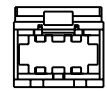
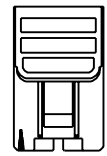

8 CKT.  
4 CKT. DUAL  
ROW - EVEN

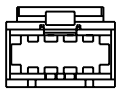
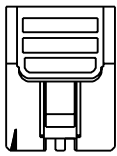

10 CKT.  
SHOWN  
ON SHT. 1

12 CKT.  
6 CKT. DUAL  
ROW - EVEN

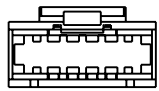
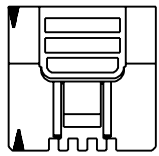

14 CKT.  
7 CKT. DUAL  
ROW - ODD

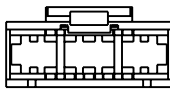
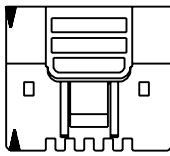

16 CKT.  
8 CKT. DUAL  
ROW - EVEN

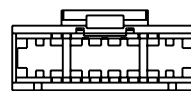
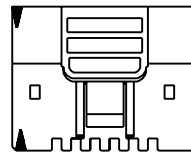

18 CKT.  
9 CKT. DUAL  
ROW - ODD

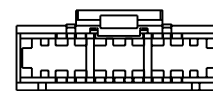
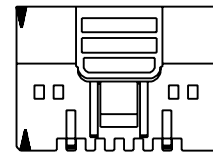

20 CKT.  
10 CKT. DUAL  
ROW - EVEN

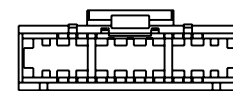
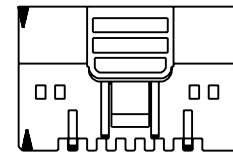

22 CKT.  
11 CKT. DUAL  
ROW - ODD

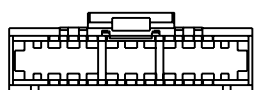
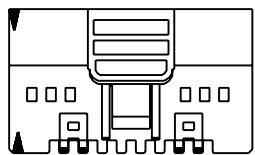

24 CKT.  
12 CKT. DUAL  
ROW - EVEN

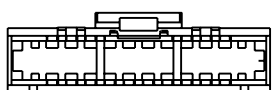
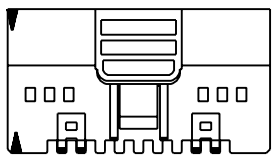

26 CKT.  
13 CKT. DUAL  
ROW - ODD

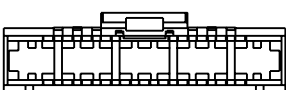
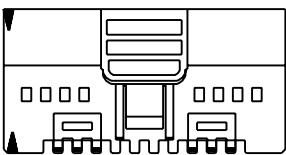

28 CKT.  
14 CKT. DUAL  
ROW - EVEN

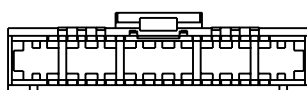
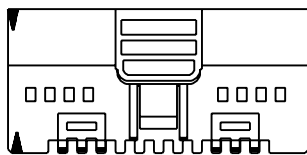

30 CKT.  
15 CKT. DUAL  
ROW - ODD

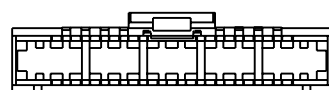
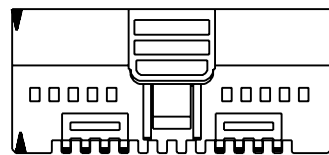

32 CKT.  
16 CKT. DUAL  
ROW - EVEN

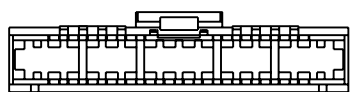
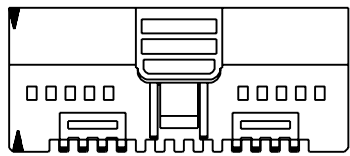

34 CKT.  
17 CKT. DUAL  
ROW - ODD

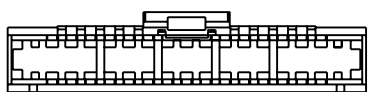
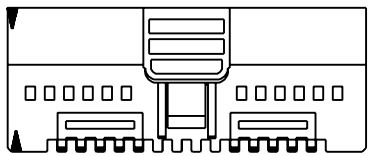

36 CKT.  
18 CKT. DUAL  
ROW - EVEN

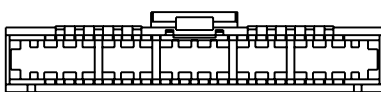
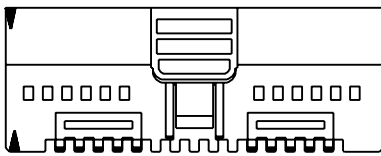

|    |             |
|----|-------------|
| L3 | SEE SHEET 1 |
| L  | SEE SHEET 1 |
| L  | SEE SHEET 1 |
| K  | SEE SHEET 1 |
| J  | SEE SHEET 1 |

|  |              |  |  |                               |  |
|--|--------------|--|--|-------------------------------|--|
| DIMENSIONS SHOWN (METRIC) INCH                         |              | ▽ = 0 ▽ = 0  |  | REVISE ONLY ON CAD SYSTEM     |  |
| UNLESS OTHERWISE SPECIFIED TOLERANCES ANGULAR ± 1/2°   |              |  |  |                               |  |
|  |              | INCH   |  | METRIC                        |  |
| 3 PLACE  | ± .010       | ---  |  | ---                           |  |
| 2 PLACE  | ± .015       | ± 0.25   |  | ---                           |  |
| 1 PLACE  | ---          | ± 0.38   |  | ---                           |  |
| DRAWING WHERE APPLICABLE MUST REMAIN WITHIN DIMENSIONS |              |  |  |                               |  |
| DRWG. BY: DJB  | CHK'D BY: DB | FILE NAME: S70013X2  |  | DRWG. NO.: SD-70013-0001-1050 |  |
| SCALE: 2:1   |              | MFG. SH. REV. LTR. REVISIONS   |  | SHEET NO. DATE                |  |
|  |              |  |  | 2 06/25/86                    |  |
|  |              | MOLEX INCORPORATED   |  | U.S.A.                        |  |
|  |              | L15LEJLL 69532   |  |                               |  |
|  |              | SEE CHART  |  | DIV. SIZE                     |  |
|  |              | THIS DRAWING CONTAINS INFORMATION THAT IS PROPRIETARY TO MOLEX INC. AND SHOULD NOT BE USED WITHOUT WRITTEN PERMISSION. |  | DP C                          |  |