



1.2MHz PWM White LED Driver with Internal Schottky Diode and Single-Wire Linear Brightness Control

General Description

The MIC3291 is a PWM switching boost regulator that is optimized for constant current white LED (WLED) driver applications. The MIC3291 features an internal Schottky diode, allowing an efficient DC/DC solution that requires only four external components.

The MIC3291 allows for a single-wire simple digital interface to control the dimming over 16 steps with a linear scale. The preprogramming feature allows the user to select any one of the 16 WLED current levels as the start up brightness level.

The feedback voltage of the MIC3291 is only 250mV, allowing high efficiency while retaining excellent accuracy for the WLED current.

The MIC3291 implements a constant frequency 1.2MHz PWM control scheme. The high frequency PWM operation saves board space by reducing external component sizes. The 1.2MHz PWM scheme also reduces switching noise and ripple to the input power source.

The 2.5V to 6.5V input voltage range of the MIC3291 allows direct operation from single cell Li-Ion as well as 3 to 4 cell NiCad/NiMH/Alkaline batteries. Battery life is preserved with a low 1 μ A shutdown current.

The MIC3291 is available in a low profile Thin SOT23 6-pin and 2mm \times 2mm MLF[®] 8-pin packages with a junction temperature range of -40°C to $+125^{\circ}\text{C}$.

Data sheets and support documentation can be found on Micrel's web site at: www.micrel.com.

Features

- Single wire combines 16 level linear brightness and shutdown control
- 18V / 25V OVP options supports up to four and six WLEDs
- Startup in any one of 16 brightness levels
- Internal Schottky diode
- 2.5V to 6.5V input voltage
- 1.2MHz PWM operation
- Over 500mA switch current
- 250mV reference voltage
- $\pm 5\%$ LED current accuracy
- $<1\mu\text{A}$ shutdown current
- UVLO and over-temperature protection
- Thin SOT23-6L package option
- 2mm \times 2mm leadless MLF[®] package option
- -40°C to $+125^{\circ}\text{C}$ junction temperature range

Applications

- Mobile handsets
- LCD handset backlighting
- Digital cameras
- Portable media players/MP3 players
- Portable applications

Typical Application

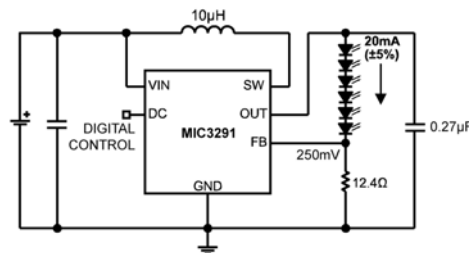

White LED Driver with OVP and Digital Control

MLF and MicroLead Frame are registered trademarks of Amkor Technologies, Inc.

Micrel Inc. • 2180 Fortune Drive • San Jose, CA 95131 • USA • tel +1 (408) 944-0800 • fax + 1 (408) 474-1000 • <http://www.micrel.com>

Ordering Information

Part Number ¹	Marking Code ⁴	Output Voltage	Over-Voltage Protection	Junction Temperature Range	Package ^{2,3}
MIC3291-18YD6	<u>W</u> 18F	Adjustable	18V	-40°C to +125°C	TSOT23-6
MIC3291-25YD6	<u>W</u> 25F	Adjustable	25V	-40°C to +125°C	TSOT23-6
MIC3291-18YML	<u>W</u> AF	Adjustable	18V	-40°C to +125°C	2mm × 2mm MLF [®]
MIC3291-25YML	<u>W</u> BF	Adjustable	25V	-40°C to +125°C	2mm × 2mm MLF [®]

Notes:

- Other options available. Contact Micrel Marketing for details.
- MLF[®] is a GREEN RoHS compliant package. Lead finish is NiPdAu. Mold compound is Halogen Free.
- MLF[®] ● = Pin 1 identifier.
- Overbar ($\bar{\quad}$) and Underbar symbols ($\underline{\quad}$) may not be to scale.

Pin Configuration

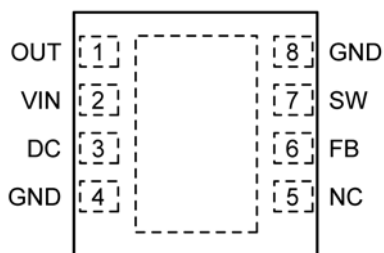

2mm × 2mm 8-Pin MLF[®] (ML)
(Top View)

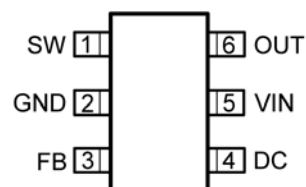

TSOT23-6 (D6)
(Top View)

Pin Description

Pin Number 8-pin MLF [®]	Pin Number SOT23-6	Pin Name	Pin Name
1	6	OUT	Output and over-voltage protection (output)
2	5	VIN	Supply (Input): 2.5V to 6.5V for internal circuitry.
3	4	DC	Single pin digital control. See diagrams.
4	–	GND	Ground (Return): Ground.
5	–	NC	No connect (no internal connection to die)
6	3	FB	Feedback (Input): Output voltage sense node. Connect the cathode of the LED to this pin.
7	1	SW	Switch Node (Input): Internal power BIPOLAR collector.
8	2	GND	Ground (Return): Ground.
Pad	–	GND	Ground (Return): Backside pad.

Absolute Maximum Ratings⁽¹⁾

Supply Voltage (V_{IN})	7.5V
Switch Voltage (V_{SW})	-0.3V to 27V
Digital Control Voltage (V_{DC})	-0.3 to V_{IN}
FB Voltage (V_{FB})	6V
Switch Current (I_{SW})	2A
Ambient Storage Temperature (T_S)	-65°C to +150°C
ESD Rating ⁽²⁾	2KV

Operating Ratings⁽³⁾

Supply Voltage (V_{IN})	2.5V to 6.5V
Output Voltage (V_{OUT})	(V_{IN} to V_{OVP})
Junction Temperature Range (T_J)	-40°C to +125°C
Package Thermal Impedance	
θ_{JA} 2mm × 2mm MLF [®] -8L	93°C/W
θ_{JA} TSOT23-6	235°C/W

Electrical Characteristics⁽⁴⁾

$T_A = +25^\circ\text{C}$, $V_{IN} = 3.6\text{V}$, $V_{OUT} = 10\text{V}$, $I_{OUT} = 20\text{mA}$, unless otherwise noted. **Bold** values indicate $-40^\circ\text{C} \leq T_J \leq +125^\circ\text{C}$.

Symbol	Parameter	Condition	Min.	Typ.	Max.	Units
V_{IN}	Supply Voltage Range		2.5		6.5	V
V_{UVLO}	Under-Voltage Lockout		1.8	2.1	2.4	V
I_{VIN}	Quiescent Current	$V_{FB} > 500\text{mV}$		2	4	mA
I_{SD}	Shutdown Current (DC Pin Low)	$V_{DC} = 0\text{V}$ for $> 2\text{ms}$.		0.01	1	μA
V_{FB}	Feedback Voltage	($\pm 5\%$)	237	250	263	mV
I_{FB}	Feedback Input Current	$V_{FB} = 250\text{mV}$		450		nA
	Line Regulation	$2.5\text{V} \leq V_{IN} \leq 4.5\text{V}$		0.5		%
	Load Regulation	$5\text{mA} \leq I_{OUT} \leq 20\text{mA}$		0.5		
D_{MAX}	Maximum Duty Cycle		86	90		%
I_{SW}	Switch Current Limit	$V_{IN} = 3.6\text{V}$	500	750	1200	mA
V_{DC}	DC Pin Thresholds	High Low	1.1		0.4	V
I_{DC}	DC Pin Current	$V_{DC} = 3.6\text{V}$		5	10	μA
$t_{shutdown}$	Shutdown Pulse Width	$V_{IN} = 2.8\text{V}$ to 5.5V $V_{DC} = \text{Low}$	1260			μs
t_{MODE_UP}	Count UP Mode Pulse Width	$V_{IN} = 2.8\text{V}$ to 5.5V $V_{DC} = \text{Low}$	100		160	μs
t_{MODE_DOWN}	Count Down Mode Pulse Width	$V_{IN} = 2.8\text{V}$ to 5.5V $V_{DC} = \text{Low}$	420		500	μs
t_{start_up}	Turn-On Delay Time	$V_{IN} = 2.8\text{V}$ to 5.5V	140			μs
t_{prog_low}	Programming Pulse Width Low	$V_{IN} = 2.8\text{V}$ to 5.5V	1		32	μs
t_{prog_high}	Programming Pulse Width High	$V_{IN} = 2.8\text{V}$ to 5.5V	1		32	μs
t_{delay}	Minimum Delay for Mode Change	$V_{IN} = 2.8\text{V}$ to 5.5V $V_{DC} = \text{High}$	140			μs
T_{prog_setup}	First Pulse Window for Preprogramming	$V_{IN} = 2.8\text{V}$ to 5.5V	35		50	μs
f_{SW}	Oscillator Frequency		1	1.2	1.35	MHz

Electrical Characteristics⁽⁴⁾ (Continued)

$T_A = +25^\circ\text{C}$, $V_{IN} = 3.6\text{V}$, $V_{OUT} = 10\text{V}$, $I_{OUT} = 20\text{mA}$, unless otherwise noted. **Bold** values indicate $-40^\circ\text{C} \leq T_J \leq +125^\circ\text{C}$.

Symbol	Parameter	Condition	Min.	Typ.	Max.	Units
V_D	Schottky Forward Drop	$I_D = 150\text{mA}$		0.8	1	V
I_{RD}	Schottky Leakage Current	$V_R = 30\text{V}$			4	μA
V_{OVP}	Over-Voltage Protection	3291- 18 only (nominal voltage)	15	16.5	18	V
		3291- 25 only (nominal voltage)	22.1	23.5	25	
T_J	Over-Temperature Threshold Shutdown			150		$^\circ\text{C}$

Notes:

- Absolute maximum ratings indicate limits beyond which damage to the component may occur. Electrical specifications do not apply when operating the device outside of its operating ratings. The maximum allowable power dissipation is a function of the maximum junction temperature, $T_{J(\text{Max})}$, the junction-to-ambient thermal resistance, θ_{JA} , and the ambient temperature, T_A . The maximum allowable power dissipation will result in excessive die temperature, and the regulator will go into thermal shutdown.
- IC devices are inherently ESD sensitive. Handling precautions required. Human body model, 1.5k Ω in series with 100pF.
- This device is not guaranteed to operate beyond its specified operating rating.
- Specification for packaged product only.

Typical Characteristics

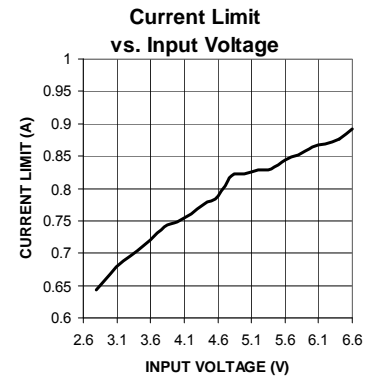
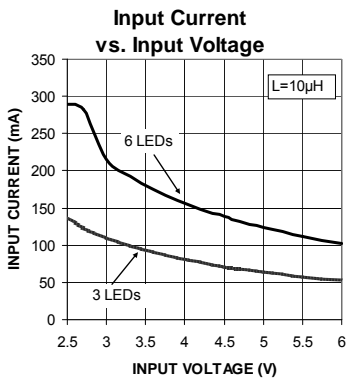
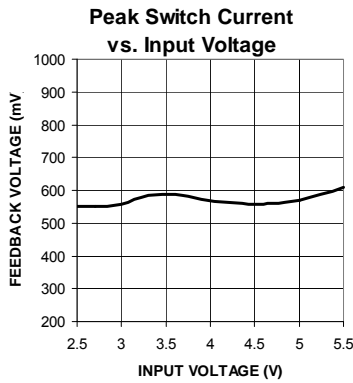
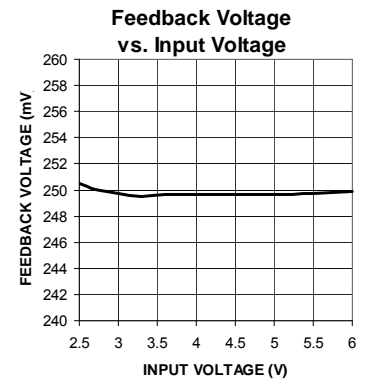
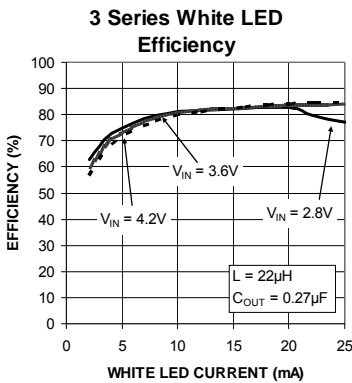
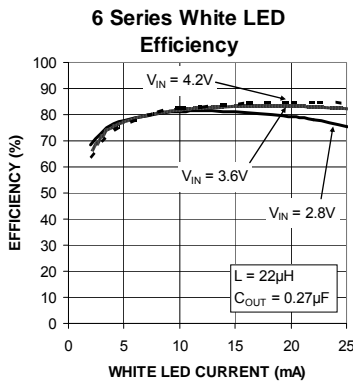
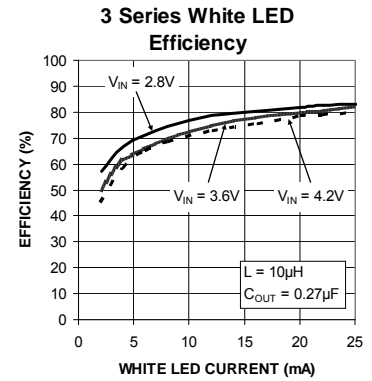
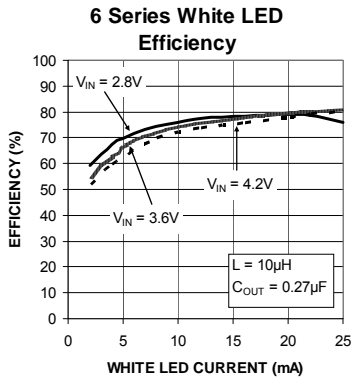
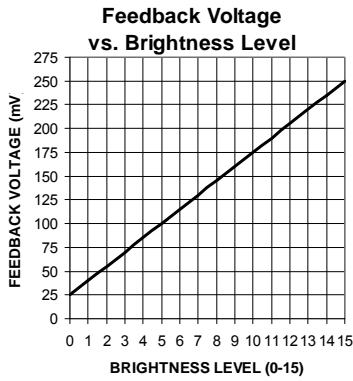

Functional Characteristics

OVP Response

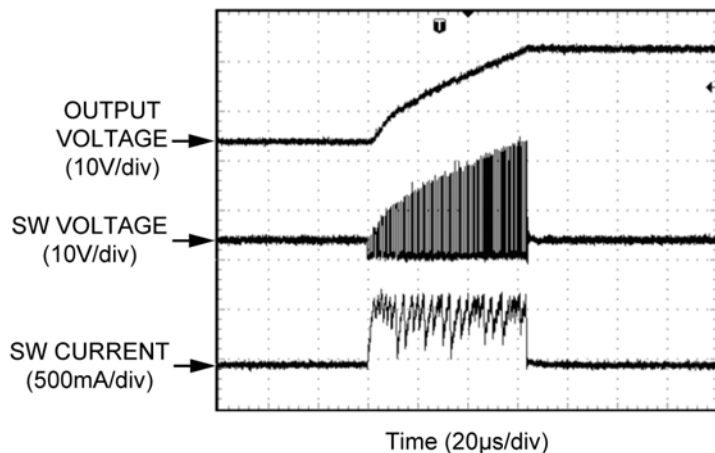

Steady State Operation (6 WLEDs)

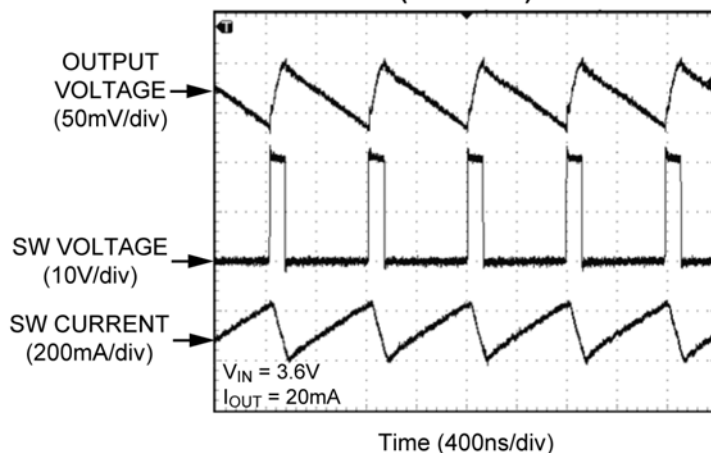

Start-Up Waveform
 $I_{OUT} = 20mA$ (6 LEDs)

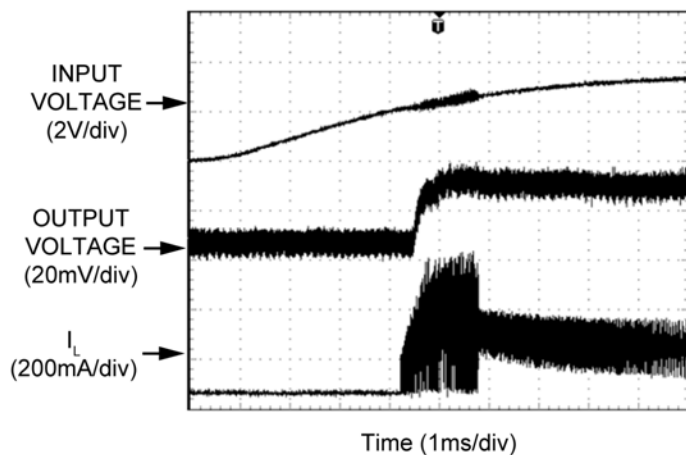

Functional Characteristics (Continued)

Step Down 1 Level (Level 11 to Level 10)

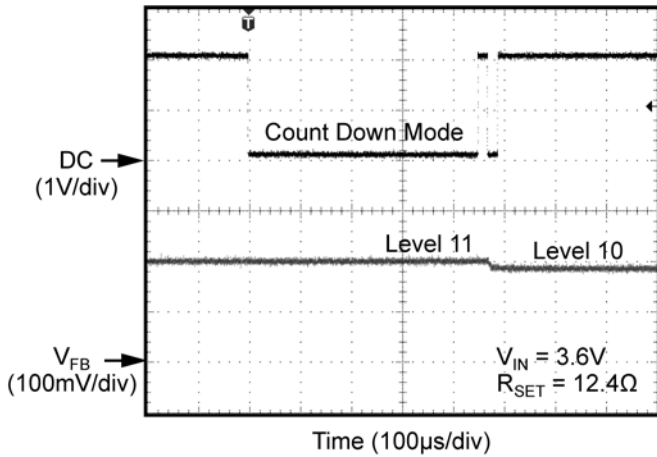

Step Up 1 Level (Level 5 to Level 6)

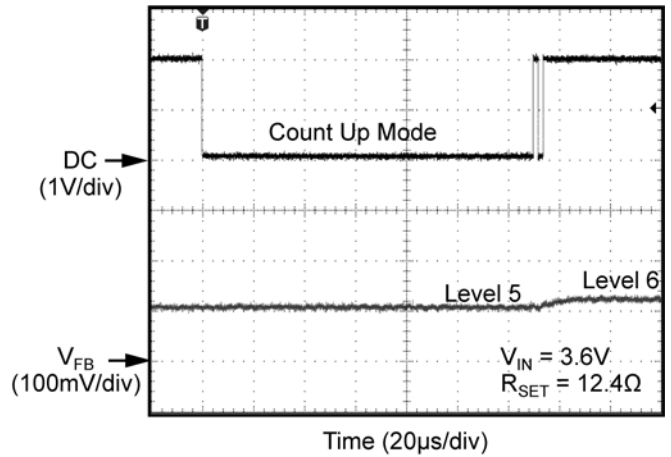

Step Down 3 Levels (Level 6 to Level 3)

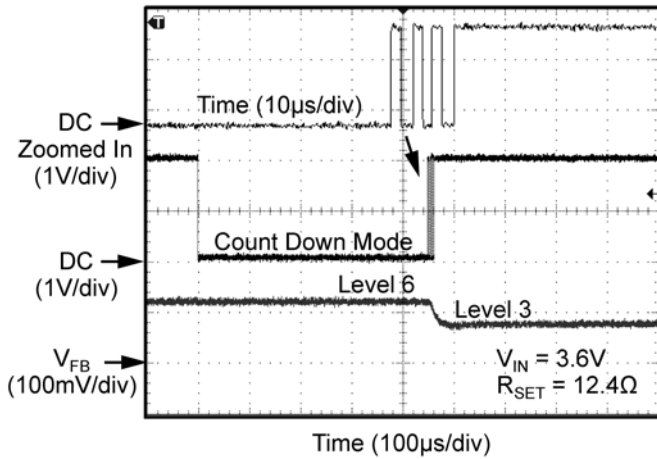

Step Up 3 Levels (Level 5 to Level 8)

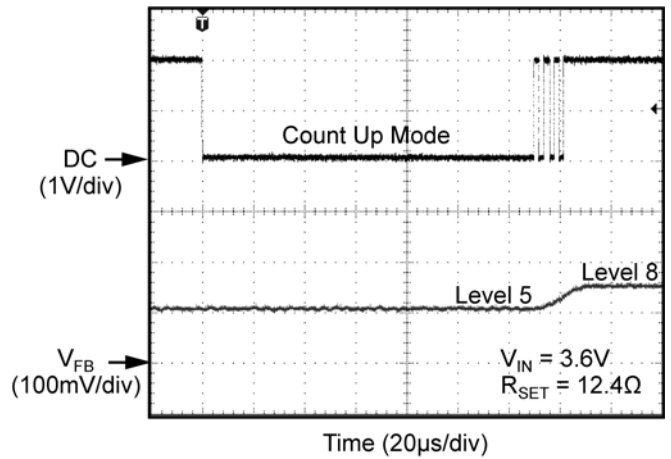

Brightness Preset (Startup to Level 8)

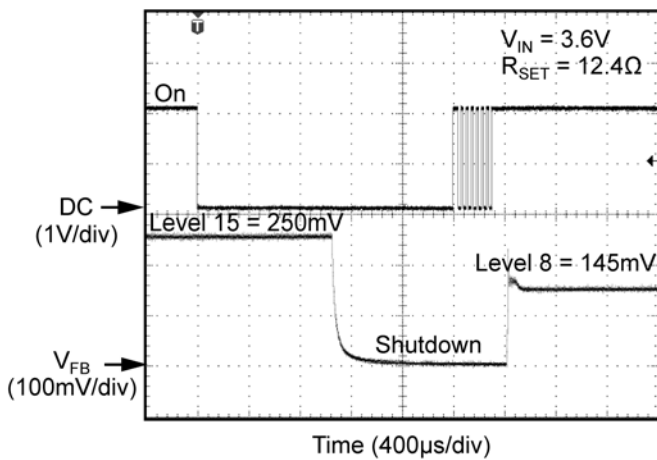

Functional Diagram

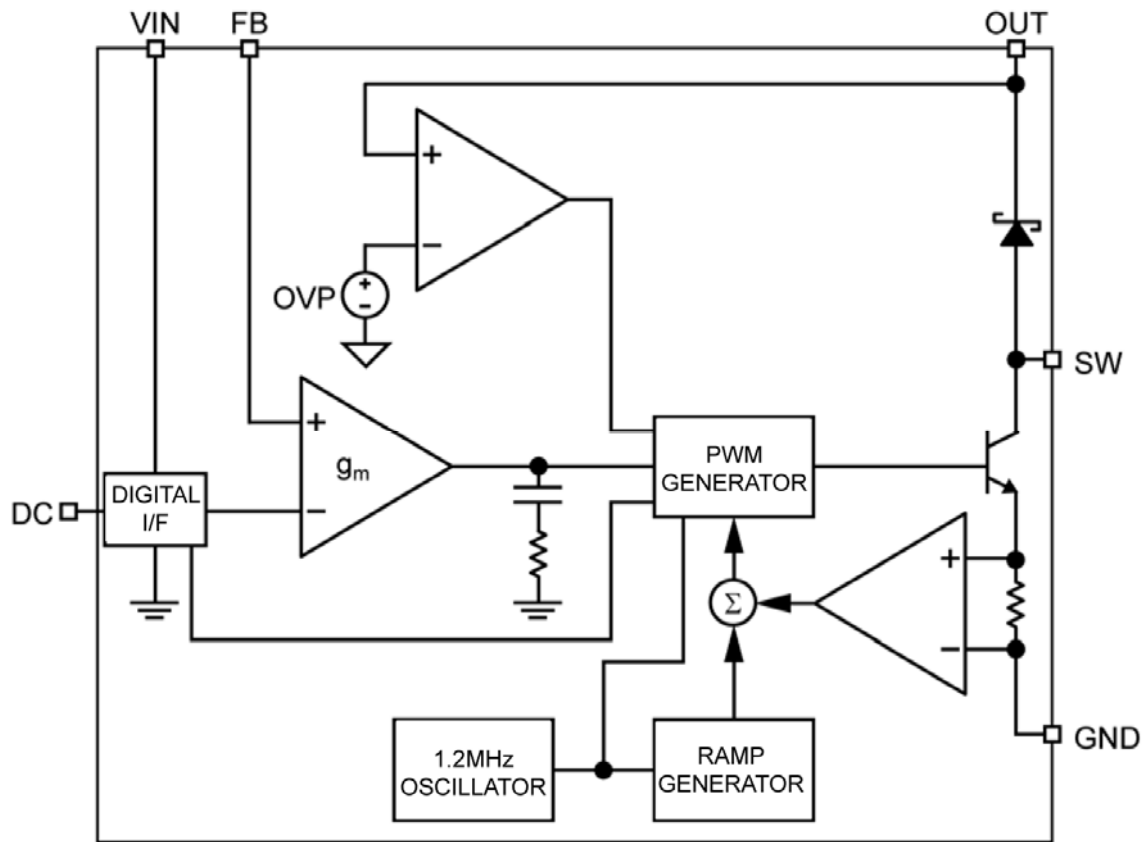

MIC3291 Block Diagram

Functional Description

The MIC3291 is a constant frequency, PWM current mode boost LED driver. It is composed of an oscillator, slope compensation ramp generator, current amplifier, gm error amplifier, PWM generator, bipolar output transistor, digital interface with D/A converter and Schottky rectifier diode. It features true single-wire linear digital control that may be used to vary the brightness of the output LEDs. The oscillator generates a 1.2MHz clock which triggers the PWM generator that turns on the output transistor and resets the slope compensation ramp generator. The current amplifier is used to measure the switch current by amplifying the voltage signal from the internal sense resistor. The output of the current amplifier is summed with the output of the slope compensation ramp generator. This summed current loop signal is fed to one of the inputs of the PWM generator.

MIC3291 Block Diagram

The gm error amplifier measures the LED current through the external sense resistor and amplifies the error between the detected signal and the reference voltage indicated by the digital interface. The output of the gm error amplifier provides the voltage loop signal that is fed to the other input of the PWM generator. When the current loop signal exceeds the voltage loop signal, the PWM generator turns off the bipolar output transistor. The next clock period initiates the next switching cycle, maintaining the constant frequency current mode PWM control. The LED current level at maximum brightness is set by the feedback resistor:

$$I_{LED} = \frac{250mV}{R_{LED}}$$

MIC3291 Digital Interface

The MIC3291 incorporates an easy to use single-wire, serial programming interface allowing users to set LED brightness to one of sixteen levels spaced in a linear manner. In contrast to other solutions requiring a PWM drive signal to maintain LED brightness, the MIC3291 is “set and forget”, relieving the controlling processor of the constant burden of supplying a drive signal. Additionally, brightness levels can be preset so that LEDs can be turned on at a particular brightness level.

Brightness Level	FB Voltage (mV)
15	250
14	235
13	220
12	205
11	190
10	175
9	160
8	145
7	130
6	115
5	100
4	85
3	70
2	55
1	40
0	25

Table 1. Brightness Level vs. Ideal FB Voltage

Startup

Presuming no presetting brightness command is issued (discussed in a later section), the MIC3291 will startup in its default state approximately 140µs (t_{START_UP}) after a logic level high has been applied and maintained at the DC pin. In the default state the LED drive current is at the maximum brightness level of 15 and brightness counter is set to count down mode. Any falling edges during the t_{PROG_SETUP} period will cause the initial brightness level of the LEDs to be below the maximum brightness level. This is discussed in more detail in the *Presetting Brightness* section.

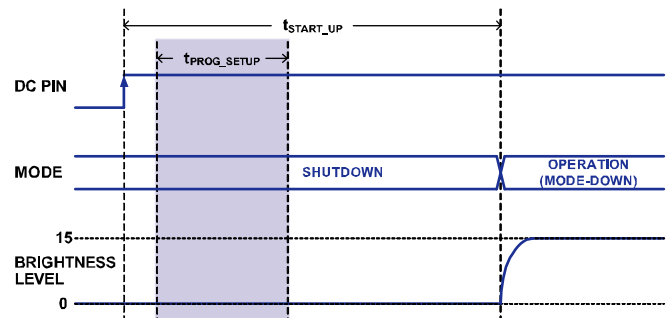

Figure 2. Typical Startup Timing

Shutdown

Whenever a logic level LOW is applied to the DC input pin for a period greater than or equal to $t_{SHUTDOWN}$ (1260 μ s), the MIC3291 will be in power saving shutdown mode.

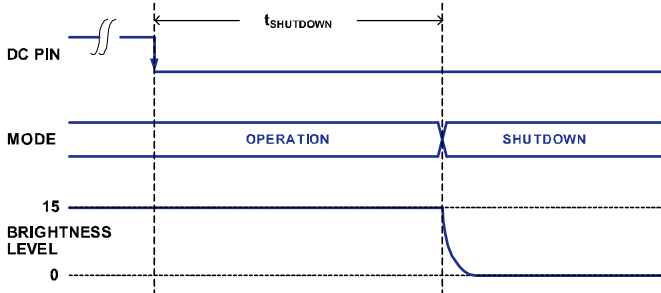

Figure 3. Shutdown Timing

Once the device is shutdown, the boost supply is disabled and the LEDs are turned off. Brightness level information stored in the MIC3291 prior to shutdown will be lost.

Programming Pulse Counter Modes

At power up the MIC3291 defaults to count down mode. In count down mode, the brightness level is decreased one level by applying two programming pulses, as shown in Figure 6. The counting mode can be changed to count up mode by pulling the DC pin LOW for a period equal to t_{MODE_UP} (100 μ s to 160 μ s). The device will remain in count up mode until its state is changed to count down mode or by disabling the MIC3291.

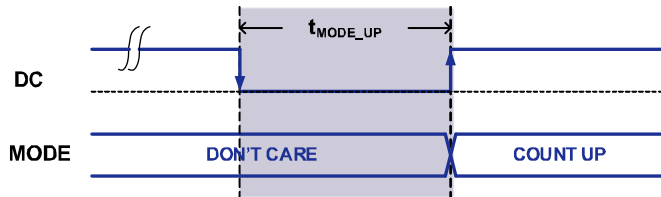

Figure 4. Mode Change to Count up

To change the state back to count down mode, pull the DC pin LOW for a period equal to t_{MODE_DOWN} (420 μ s to 500 μ s). Now the internal circuitry will remain in count down mode until changed to count up mode as described previously.

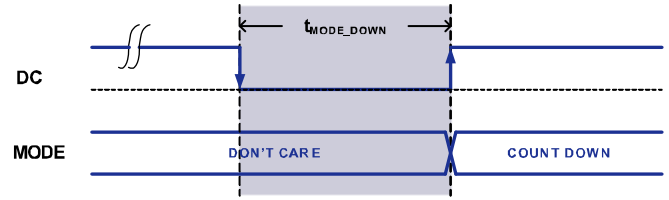

Figure 5. Mode Change to Count Down

Programming the Brightness Level

MIC3291 is designed to start driving the output LEDs (t_{START_UP}) in 140 μ s at the maximum brightness level of 15. After startup, the internal control logic is ready to decrease the LED brightness upon receiving programming pulses (negative edges applied to DC pin). Since MIC3291 starts in count down mode, the brightness level is decreased one level by applying two programming pulses, as shown in Figure 6. Each programming pulse has a high (t_{PROG_HIGH}) and a low (t_{PROG_LOW}) pulse width that must be between 1 μ s to 32 μ s. Note that n+1 number of pulses are needed to decrease brightness by n level(s) since the first clock pulse is ignored. Ignoring the first clock pulse is necessary so mode change (t_{MODE_UP} , t_{MODE_DOWN}) pulses do not result in adjustments to the brightness level. The MIC3291 internal circuit can be changed from count down mode to count up mode and vice versa. The user may elect to send a mode change as shown in Figure 4 to set the MIC3291 to step up the brightness level with subsequent programming pulses. For proper operation, ensure the DC pin has remained HIGH for at least t_{DELAY} (140 μ s) before issuing a mode change command.

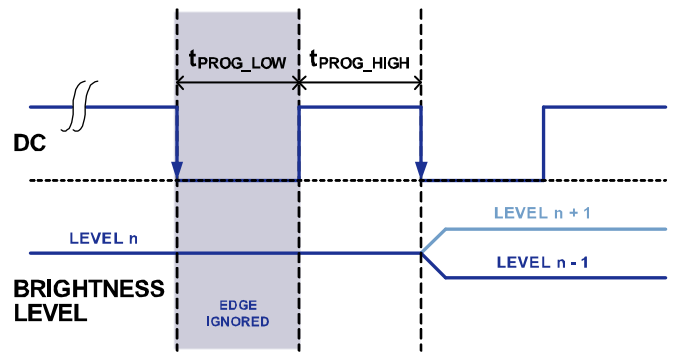

Figure 6. Brightness Programming Pulses

Multiple brightness levels can be changed together with multiple programming pulses, as shown in Figure 7. When issuing multiple brightness level adjustment commands to the DC pin, ensure both t_{PROG_LOW} and t_{PROG_HIGH} are within 1 μ s and 32 μ s.

To maintain operation at the current brightness level simply maintain a logic level high signal at the DC pin.

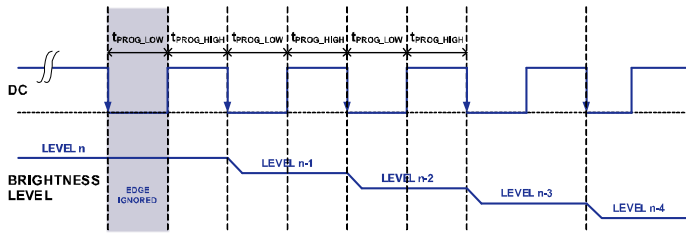

Figure 7. Decreasing Brightness Several Levels

As mentioned, MIC3291 can be programmed to set LED drive current to produce one of 16 distinct brightness levels. The internal logic keeps track of the brightness level with an up/down counter circuit. The *Counter Rollover* section explains how the brightness counter functions with continued programming edges.

Counter Rollover

The MIC3291 internal up/down counter contains registers from 0 to 15. When the brightness level is at 0 and a programming pulse forces the brightness to step down, then the counter will rollover to Level 15. This is illustrated in Figure 8.

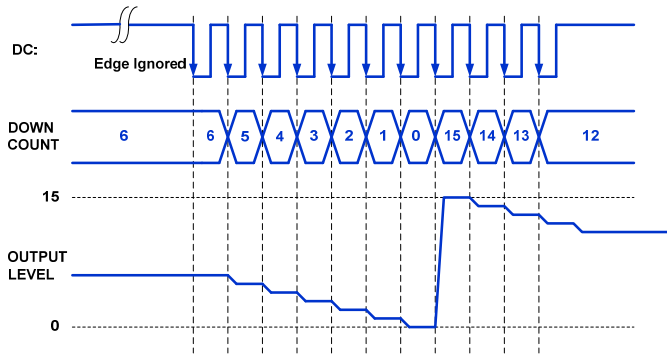

Figure 8. Down Counter Rollover

Similarly, when the counter mode is set to count up and a programming pulse forces the brightness level to step up from level 15, then the counter will rollover to level 0 as illustrated in Figure 9.

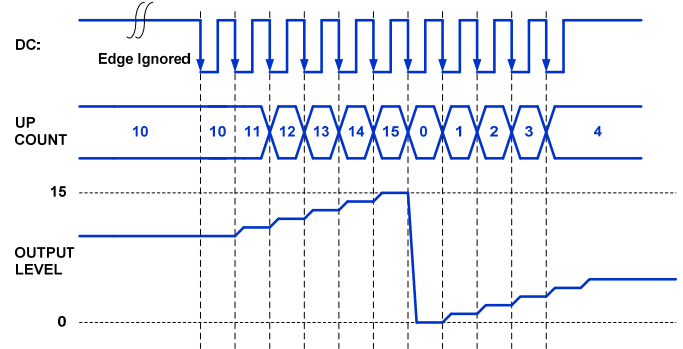

Figure 9. Up Counter Rollover

One Step Brightness Changes

For applications where a keypad button press is to be translated into a brightness level change, the following method of decreasing the brightness level may be useful. This “one step” brightness change procedure relieves the user from keeping track of the MIC3291’s up/down counter mode. It combines a counter mode change with a programming pulse, therefore a one step decrease in brightness is assured no matter what the previous up/down counter mode was.

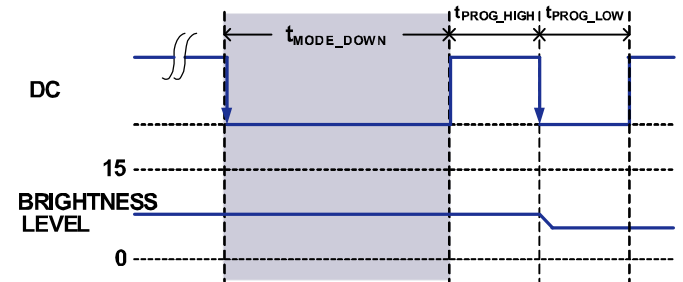

Figure 10. One step Brightness Decrease

This method is quite simple and the only requirement is that the first DC LOW period be equal to the t_{MODE_DOWN} (420µs to 500µs) and immediately followed by a falling edge within t_{PROG_HIGH} (1µs to 32µs) as shown in Figure 10 for one step brightness decrease. Similarly a one step increase can be assured by first generating a DC down pulse whose period is equal to the t_{MODE_UP} (100µs to 160µs) and immediately followed by a falling edge within t_{PROG_HIGH} (1µs to 32µs). Figure 11 illustrates the proper timing for execution of a one step brightness increase.

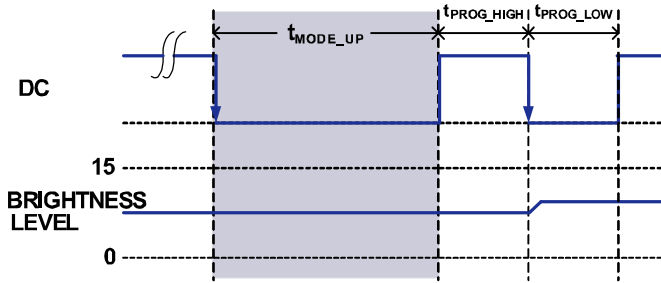

Figure 11. One step Brightness Increase

Figure 12 shows the correct presetting sequence to set the MIC3291 brightness to Level 6 prior to startup. The sequence is initiated by driving the DC pin LOW for a period exceeding $t_{SHUTDOWN}$ (1260 μ s) to insure that the part has entered the power saving shutdown state erasing all brightness level state and mode setting. Then the DC pin is driven HIGH and the first presetting pulse edge is entered within the t_{PROG_SETUP} window. Notice that when using the presetting feature the first programming pulse is not ignored. This is because the counter's default mode is count down and a mode change cannot be performed in the presetting mode. (Note that the same timing requirements of standard brightness programming also apply during presetting brightness.)

Presetting Brightness

The brightness level can be preset before the MIC3291 begins to drive the LEDs by sending a series of programming edges via the DC pin during the t_{START_UP} (140 μ s) period and between 35 μ s to 50 μ s after the DC pin is first pulled HIGH. The 15 μ s timeframe between 35 μ s and 50 μ s is the t_{PROG_SETUP} period. The MIC3291 does not drive current into the load until DC pin is kept HIGH for t_{START_UP} (140 μ s) after presetting has concluded in order to grant the user sufficient time to preset LED brightness. The first presetting pulse edge must occur somewhere between the timeframe of 35 μ s to 50 μ s after DC pin is first pulled HIGH otherwise the MIC3291 may continue to start at the full (default) brightness level.

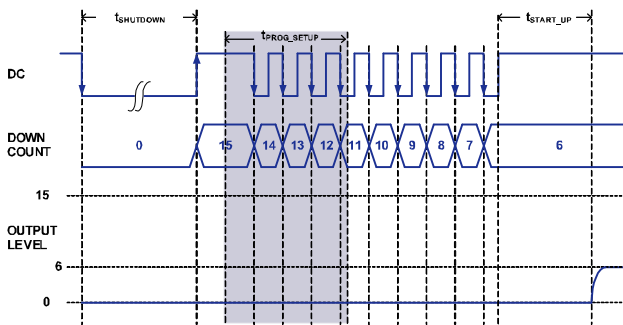
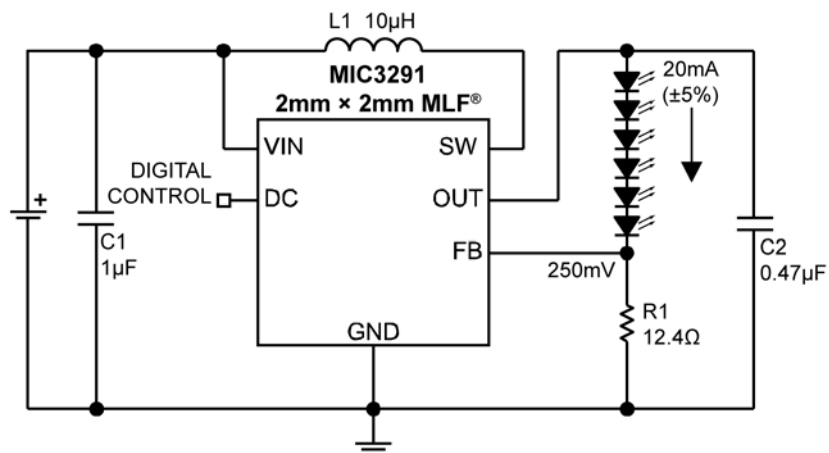

Figure 12. Preset Timing

Typical Application Circuit (MIC3291-xxYML)



Bill of Materials

Item	Part Number	Manufacturer	Description	Qty.
C1	GRM185R61A105KE36D	Murata ⁽¹⁾	Capacitor, 1µF Ceramic, 10V, X5R, Size 0603	1
C2	GRM21BR71E474KCO1L	Murata ⁽¹⁾	Capacitor, 0.47µF Ceramic, 25V, X7R, Size 0805	1
R1	CRCW060312R40FRT1	Vishay ⁽²⁾	12.4Ω, 1%, 0603	1
L1	VLS252010T-100M	TDK ⁽³⁾	10µH, 650mA, 712mΩ, L2.5mm x W2.0mm x H1.0mm	1
U1	MIC3291-xxYML	Micrel, Inc. ⁽⁴⁾	1.2MHz PWM Boost LED Driver with Single-Wire Linear Digital Control	1

Notes:

1. Murata: www.murata.com.
2. Vishay: www.vishay.com.
3. TDK: www.tdk.com.
4. Micrel, Inc.: www.micrel.com.

Typical Application Circuit (MIC3291-xxYD6)

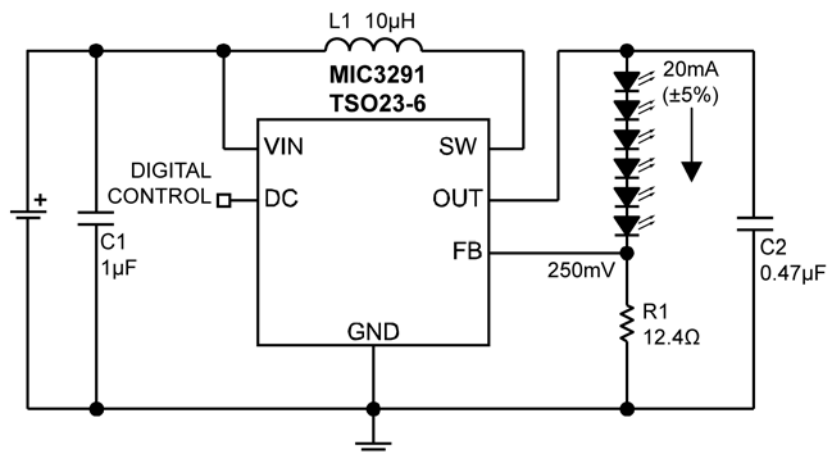

Bill of Materials

Item	Part Number	Manufacturer	Description	Qty.
C1	GRM185R61A105KE36D	Murata ⁽¹⁾	Capacitor, 1µF Ceramic, 10V, X5R, Size 0603	1
C2	GRM21BR71E474KCO1L	Murata ⁽¹⁾	Capacitor, 0.47µF Ceramic, 25V, X7R, Size 0805	1
R1	CRCW060312R40FRT1	Vishay ⁽²⁾	12.4Ω, 1%, 0603	1
L1	VLS252010T-100M	TDK ⁽³⁾	10µH, 650mA, 712mΩ, L2.5mm x W2.0mm x H1.0mm	1
U1	MIC3291-xxYD6	Micrel, Inc. ⁽⁴⁾	1.2MHz PWM Boost LED Driver with Single-Wire Linear Digital Control	1

Notes:

1. Murata: www.murata.com.
2. Vishay: www.vishay.com.
3. TDK: www.tdk.com.
4. Micrel, Inc.: www.micrel.com.

PCB Layout Recommendations

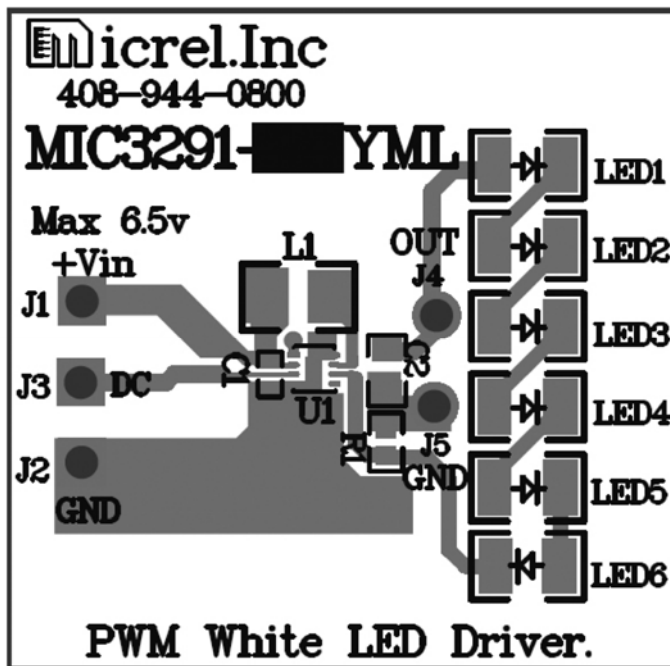

Top Layer



Bottom Layer

Package Information

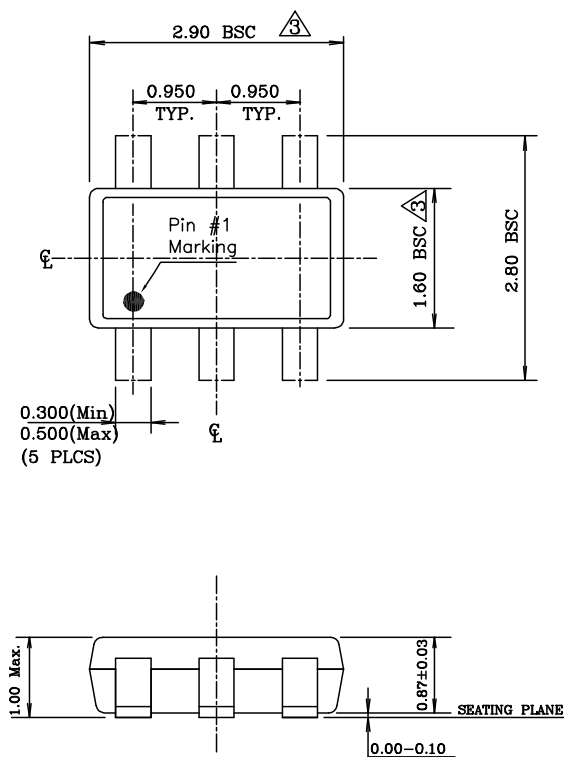

NOTE:

1. Dimensions and tolerances are as per ANSI Y14.5M, 1994.
2. Die is facing up for mold. Die is facing down for trim/form, ie. reverse trim/form.
3. Dimensions are exclusive of mold flash and gate burr.
4. The footlength measuring is based on the gauge plane method.
5. All specification comply to Jedec Spec MO193 Issue C.
6. All dimensions are in millimeters.

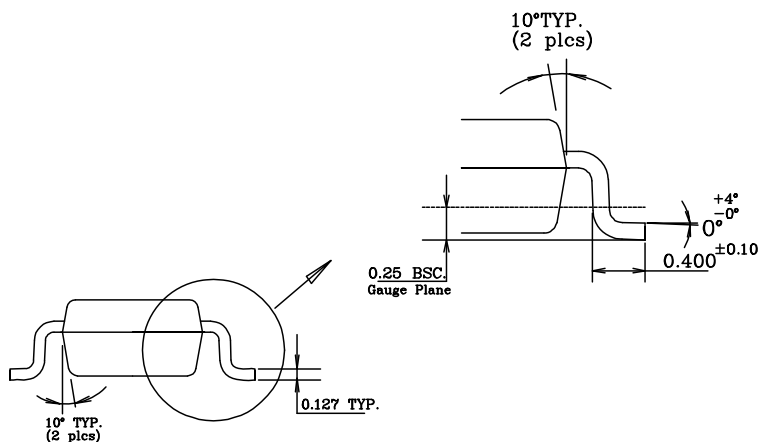

6-Pin TSOT23 (D6)

Package Information (Continued)

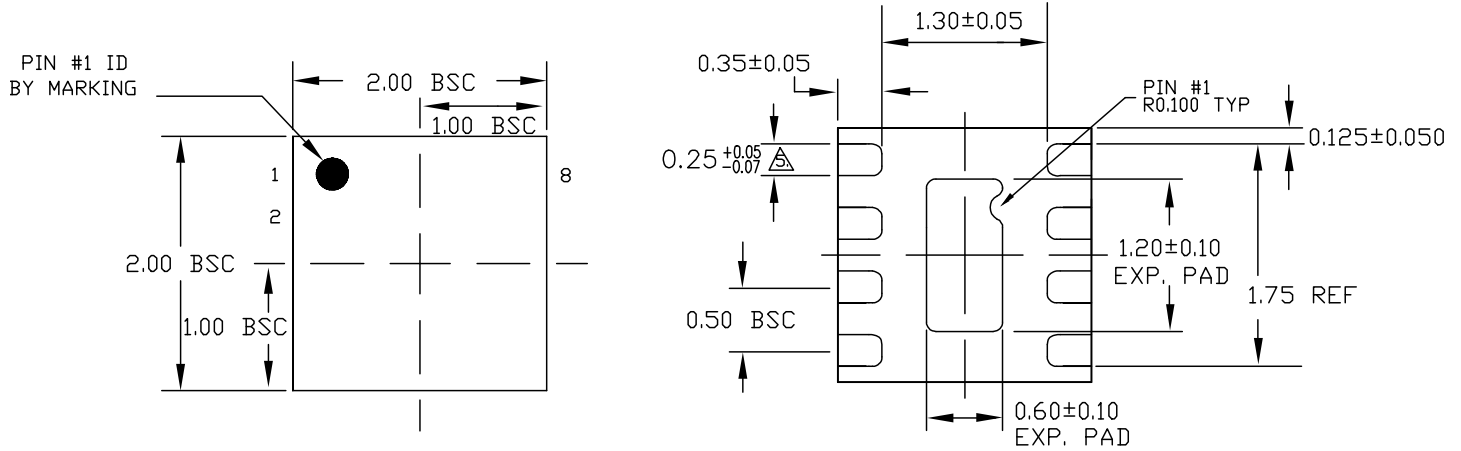

TOP VIEW

BOTTOM VIEW

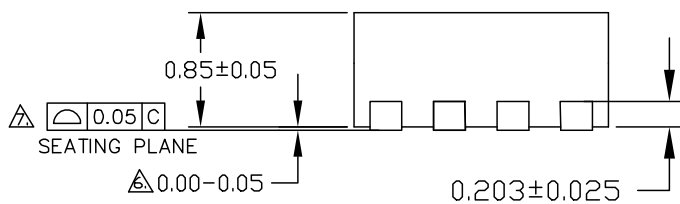

SIDE VIEW

- NOTE:
1. ALL DIMENSIONS ARE IN MILLIMETERS.
 2. MAX. PACKAGE WARPAGE IS 0.05 mm.
 3. MAXIMUM ALLOWABLE BURRS IS 0.076 mm IN ALL DIRECTIONS.
 4. PIN #1 ID ON TOP WILL BE LASER/INK MARKED.
- △ DIMENSION APPLIES TO METALIZED TERMINAL AND IS MEASURED BETWEEN 0.20 AND 0.25 mm FROM TERMINAL TIP.
- △ APPLIED ONLY FOR TERMINALS.
- △ APPLIED FOR EXPOSED PAD AND TERMINALS.

8-Pin MLF® (ML)

MICREL, INC. 2180 FORTUNE DRIVE SAN JOSE, CA 95131 USA
 TEL +1 (408) 944-0800 FAX +1 (408) 474-1000 WEB <http://www.micrel.com>

The information furnished by Micrel in this data sheet is believed to be accurate and reliable. However, no responsibility is assumed by Micrel for its use. Micrel reserves the right to change circuitry and specifications at any time without notification to the customer.

Micrel Products are not designed or authorized for use as components in life support appliances, devices or systems where malfunction of a product can reasonably be expected to result in personal injury. Life support devices or systems are devices or systems that (a) are intended for surgical implant into the body or (b) support or sustain life, and whose failure to perform can be reasonably expected to result in a significant injury to the user. A Purchaser's use or sale of Micrel Products for use in life support appliances, devices or systems is a Purchaser's own risk and Purchaser agrees to fully indemnify Micrel for any damages resulting from such use or sale.

© 2010 Micrel, Incorporated.