

THE NEW VISION OF TOUCH™

QSlide™

QUANTUM

QUANTUM

E401

User Manual

The New Vision of Touch™

E401

User Manual



OVERVIEW

This kit is designed for evaluation and development of QT401-based QSlide™ slider controls. It includes a fully assembled slider PCB, demo control panel, cables and software. The E401 has serial interface allowing connection to a PC for control and data viewing via an included USB to SPI adapter and PC software.

For more detailed information about this product please refer to the QT401 datasheet.

Materials Provided:

- 1 x White plastic slider demo panel
- 1 x E401 evaluation board with self-adhesive on one side
- 6 x Rubber feet
- 1 x USB-PC cable
- 1 x USB-SPI adapter with USB-SPI cable to the E401
- 1 x Spare SPI cable for user connection to a microcontroller
- 2 x Sample QT401-IS ICs
- 1 x CD-ROM with QSlide™ software and USB drivers
- 1 x User Guide

CONTENTS

BOARD PREPARATION	Page 2
RUNNING THE E401	Page 3
QSLIDE™ SOFTWARE OPERATION	Page 4
BOARD DETAILS	Page 6
SCHEMATIC DIAGRAM	Page 8
PCB LAYOUT	Page 9
SOFTWARE INSTALLATION (CD)	Page 10
SOFTWARE INSTALLATION (WEB)	Page 11
REAL WORLD APPLICATION	Page 12
TROUBLESHOOTER	Inside Back Cover

The E401 PCB can be adhered to plastic, glass, or any other dielectric panel. A white sample panel is included. Please follow these steps to mount the E401 PCB to the sample panel:

- 1 Use normal ESD precautions when working with the E401 !!
- 2 Place the user panel face down on a table —
Tape down the edges of the panel to the table so it cannot move while you work with it.
- 3 Remove the paper backing from the E401 PCB and adhere it to the rear of the user panel.
Bend the PCB slightly as shown while smoothing it to remove any air bubbles.

Tip: Line up the PCB with the alignment marks on the back of the slider panel. **The PCB must be positioned with the connector on the underside of the QSlide™ logo.** The PCB does allow some flexing, but care must be taken not to bend it too far as this can crack the SMT components.

- 4 Mount the 6 rubber feet as shown to make the E401 mechanically stable in use.

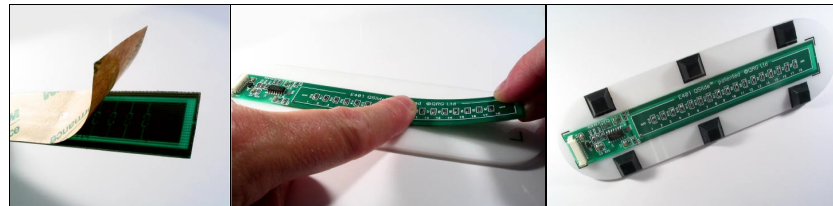

To Run the E401, Please Follow These Steps:

1 IMPORTANT: First install QSlide™ software and USB drivers (see page 10).

- 2 Make sure the USB adapter box is NOT plugged into your PC at this time.
- 3 Connect the E401 to the USB box with the red USB-SPI cable
- 4 Connect the USB adapter to your running PC and wait at least 10 seconds so that the USB adaptor is properly recognized. The USB box's LED should come on solid.
- 5 Run the QSlide™ software (Qslide_V[x].exe) which should be on your desktop or other location where you copied it. See next page for details.
- 6 With your hands far removed from the E401: Click on the FIXED CAL button first, then after 1 or 2 seconds, the ADAPTIVE CAL button.
- 7 Slowly move your hand towards the slider. The proximity alert status box will indicate when your hand is still several cm away from the panel.
- 8 Touch the slider area with a finger. You can either slide your finger across the surface or touch the slider at any point. When you remove your finger, the last position touched will be locked on the display.

Things to Try:

- Alter the proximity and detect thresholds using the pull down menus to change the sensitivity to proximity and touch. The higher the threshold, the less sensitive the E401 will become.
- Change the rate of environmental drift compensation with the DRIFT RATE dropdown. This affects how fast the sensor will compensate for slow environmental changes. Normally this should be set to a very slow rate (once per 3 or 4 seconds). Faster rates can cause complications with proximity and touch detection.

4 QSLIDE™ SOFTWARE OPERATION

Warning: *Disconnecting the USB cable from the PC while QSlide software is communicating with the E401 board may crash the software. Please close the QSlide software before unplugging the USB cable.*

QSlide software should automatically detect the correct com port; if not, you may need to select the port manually as shown below. If the correct port (usually a com port higher than 3) does not appear, close the program, wait 30 seconds, and try again — Windows may be slow to recognize the USB hardware.

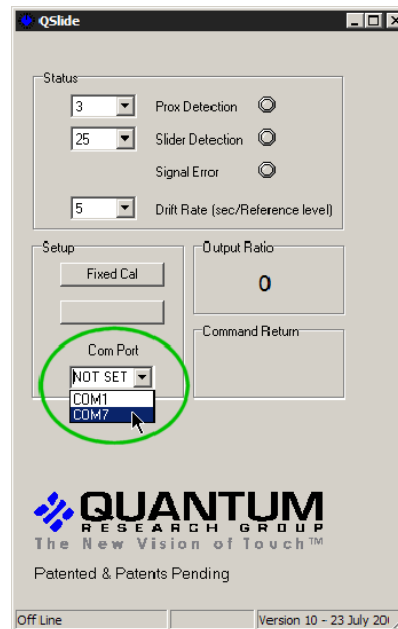

Prox Detection indicates that the board has detected a hand at a distance.

The Prox value sets the threshold which will cause the chip to register proximity; lower numbers are more sensitive. Default = 3

Calibration should be performed with the PCB in the intended position in which it will be used, with hands at a distance, to get a valid reference level. Once positioned, the board should be calibrated using the **Fixed Cal** button.

Note: Fixed Cal must precede Adaptive Cal, otherwise the end calibrations will be inaccurate.

Clicking **Fixed Cal** alone will cancel **Adaptive Cal**.

If the board is moved it may need to be recalibrated.

If any status flags are set prior to operation then calibration should be repeated.

Clicking **Adaptive Cal** causes the E401 to match the electrical endpoints to the physical ends using a special calibration process.

Do this only **after** clicking **Fixed Cal**.

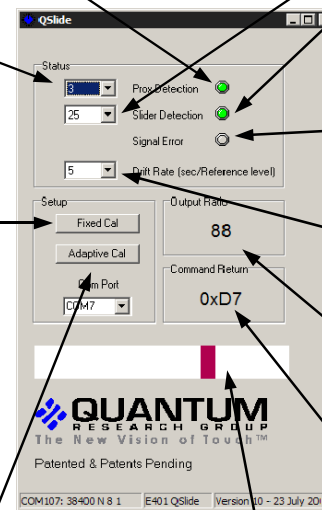

Slider Bar shows the reported position of touch. This bar does not move when only proximity is detected. It will lock on the last reported position after touch is lifted.

Slider Detection indicates that the board is detecting a finger touch.

Changing the associated threshold sets the amount of signal change which will cause the E401 to register touch. Default = 25

Signal Error indicates that the signal has the wrong polarity, usually due to board movement.

Clicking the **Fixed Cal** then **Adaptive Cal** buttons will resolve the error.

Drift Rate sets the adaptive drift compensation rate; the numbers represent seconds per compensation.

Output Ratio shows the numerical slider position, from 0 (left) to 127 (right).

Command Return represents the QT401's response status byte in hexadecimal. This is useful for diagnostic purposes.

SPI Interface Connector

This connector provides all signals and power needed to communicate with the USB adapter or an external host such as a microcontroller.

See **Table 1** (*next page*) for a description of the connector pinout.

Voltage Regulator

The E401 uses a low drop out regulator to regulate the 5V coming from the USB adapter box down to 3.3V. Resistor R25 is used to provide a minimum load on the regulator when the QT401 goes to sleep between acquisitions; this is necessary for regulator transient stability.

Since the QT401 works on a lower voltage (3.3V) than the USB box (5.0V), the signals from the USB box to the E401 must be level shifted down. This is done using resistive dividers consisting of 1K resistors R20, R21 and R22, plus a set of 560 ohm resistors placed in series with the signal lines inside the USB box.

Slider Element

The capacitive slider consists of the 17 resistors R2...R18 and the copper pads they connect. The end-to-end resistance of the slider element is about 95K ohms. Resistors R1 and R19 are zero ohms but can be changed to allow manual trimming of the end-positions of the slider if adaptive calibration is not used. Increasing R1 and/or R19 will move the ends outwards.

Sampling Capacitors

C1 and C2 are the Cs sampling capacitors; increasing their value will increase sensitivity and resolution of measurement, but will also tend to make for a slower response time.

Figure 1 — Board Layout

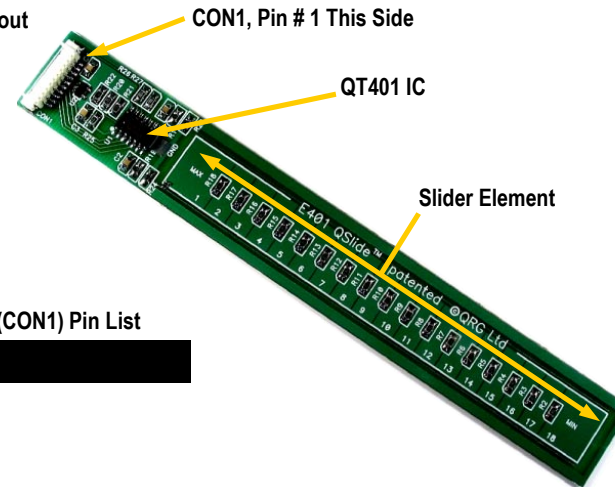

Table 1 — Connector (CON1) Pin List

Pin	Description
1	0V (Ground)
2	+5V power
3	+5V power
4	DRDY—data ready (output)
5	SDO—serial data (output)
6	/SS—slave select (input)
7	SCLK—serial clock (input)
8	SDI—serial data (input)
9	Detect—active high (output)
10	Prox—active high (output)

Figure 2 —
Schematic
Diagram

Figure 3 — Silk Layer



Figure 4 — Top Layer

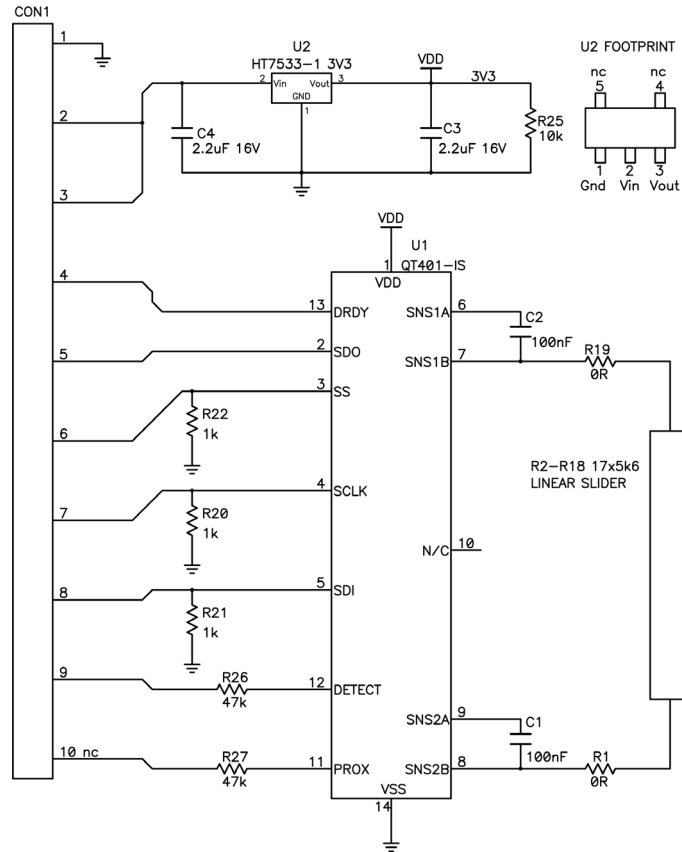
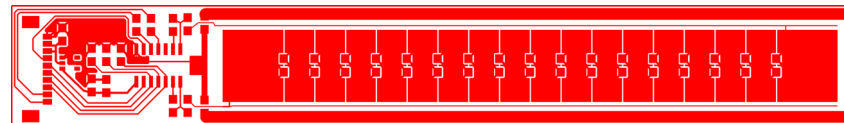

Table 2 — Operating Range

Temperature	-20°C to +60°C
Supply Voltage	4.75-15VDC

10 SOFTWARE INSTALLATION (CD)

If you have a Quantum CD-ROM, follow these steps to install QSlide™ software and USB drivers. If you previously installed such drivers, do not install them again. *If you experience problems, make sure you have administrative rights (e.g. under XP Pro).*

Install the QSlide™ Signal Viewing Software

To install the QSlide™ viewing software, simply copy the file *Qslide_V[x].exe* from the supplied CD to your Windows Desktop. The software can be found on the CD in folder **D:\SOFTWARE** (replace **D:** with the actual drive letter of your CD)

Install the USB Drivers

Place the CD-ROM in your CD drive.

Connect the USB adapter box to the PC using the supplied USB cable. The E401 may be connected (or not).

Windows will display the **Found New Hardware Wizard** for the **USB <-> Serial Cable**. Select **Install the software automatically** and click **Next**. Windows now installs the drivers. Click **Finish** when prompted.

The **Found New Hardware Wizard** will appear again for the **USB Serial Port** device. Simply repeat the above steps again.

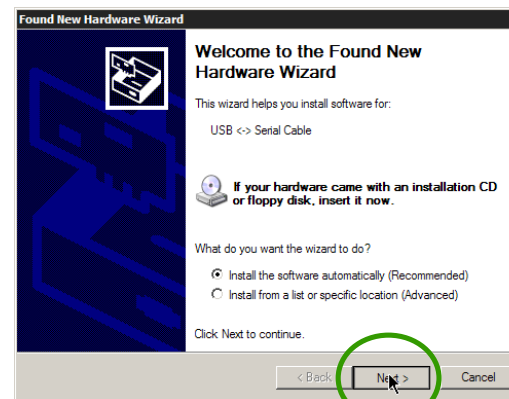

Windows may prompt you to restart your PC at this point; **restarting is not necessary**.

You are now done with the software and driver installation. Go back to page 3.

SOFTWARE INSTALLATION (WEB) 11

Follow these steps to install QSlide™ software and USB drivers from www.qprox.com. If you previously installed such drivers, do not install them again. *If you experience problems, make sure you have administrative rights (e.g. under XP Pro).*

Create New Folder C:\QRG-USB

Create a new temporary folder to hold the files you are about to download, called **C:\QRG-USB**

Download and Extract the Files

Go to www.qprox.com/software and click on the file [qrg-usb_drivers.zip](#) and click **Save**; save the file to **C:\QRG-USB**. Extract all files inside [qrg-usb_driver.zip](#) within folder **C:\QRG-USB**.

Now, download QSlide™ software ([Qslide_V\[x\].exe](#)) but save this to your Windows Desktop.

Install the USB Drivers

Follow the USB directions on page 10 except:

When the **Found New Hardware Wizard** appears, select **Install from a list or specific location**. Then, specify the location as **C:\QRG-USB** and click **Next**.

Windows will now install the drivers.
Click **Finish** when prompted.

The **Found New Hardware Wizard** will appear again for the **USB Serial Port** device. Simply repeat the above steps again.

You may be prompted to restart your PC; **restarting is not necessary**. You may now delete the temporary folder **C:\QRG-USB**.

You are now done with the software and driver installation. Go back to page 3.

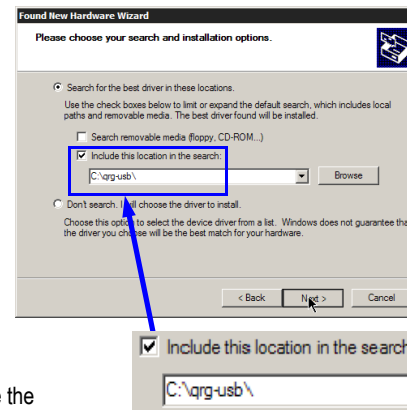

QSlide™ Concept Cooktop

This concept cooktop was modified from a commercially available unit to demonstrate several advanced Quantum touch control features.

A central feature is the QSlide™ control used to dial in the power level from 0 to 99. The single slider is shared among the four burners by means of 4 burner select buttons and 4 LED power displays. Touching one of these 4 burner buttons enables the slider to control the power level on that burner. The 2-digit LED for that burner tracks the power level setting.

Another advanced feature is a unique 'slide-on' touch control switch that is child-resistant yet easy for an adult to use. It operates much like a conventional slide switch: sliding your finger up turns on the appliance. Turning the appliance off is easy: just touch anywhere in the power button area.

This cooktop uses both QTTouch™ and QSlide™ technologies. QTTouch™ and QSlide™ technology are patented and patent pending worldwide.

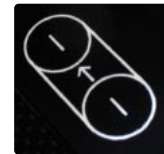

The power button features a unique, patent-pending, 'slide-on' touch method that helps prevent accidental operation.



The slider control is shared among the four burners. Touch one of the four burner touch buttons, and the LEDs for that burner become brighter. The slider will then work to change power level for that burner.

TROUBLESHOOTER

Board Will Not Communicate with PC

▶ Bad SPI or USB Connections

- ⇒ Check/replace cables
- ⇒ Make sure the board is getting power and USB light is on solid

▶ Bad or Conflicting Virtual Comm Port on PC

- ⇒ See the *Software Installation* section - reinstall driver software, or, change the USB-Serial com port number in Device Manager if there is a conflict

▶ LED Flashes on USB Adapter (USB box not recognized)

- ⇒ Disconnect and reconnect the board and USB adapter, take care to connect the QSlide™ board to the USB adapter first as USB box detects the QSlide™ board on power up.

▶ Board will not Calibrate due to noise (failure to calibrate will cause the board to cease communications)

- ⇒ See below — Noisy or erratic signal

Noisy or Erratic Signal

▶ Noisy Power Supply - try a different USB port or PC

▶ Cables or Board too Close to Strong Noise Source (such as a power line or switching noise source)

- ⇒ Increase the distance from E401 to the noise source
- ⇒ Place a grounded metal shield between the noise source and the QSlide™ board

▶ QSlide™ Board is not Mechanically Stable

- ⇒ Prevent board from moving around

▶ Strong RFI from a Transmitter or Adjacent Digital Product

- ⇒ Remove the noise source or shield against it

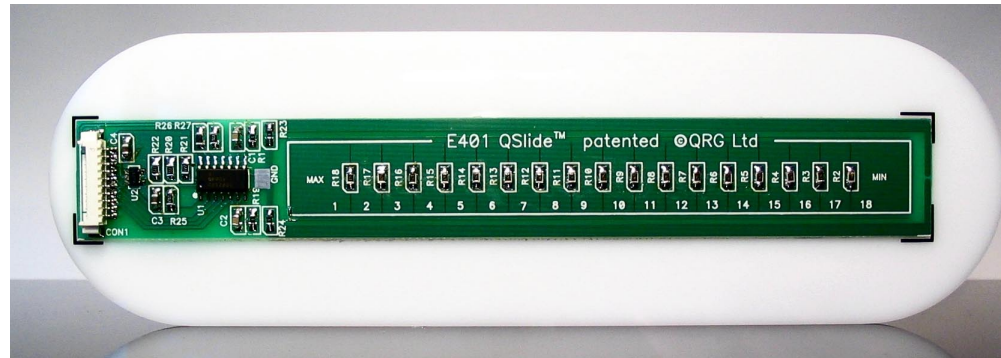

 **QUANTUM**
RESEARCH GROUP
www.qprox.com

Development Team: Martin Simmons, Luben Hristov, Samuel Brunet

Corporate Headquarters

1 Mitchell Point
Ensign Way, Hamble
Southampton SO31 4RF
United Kingdom

Tel +44 (0)23 8056 5600
Fax +44 (0)23 8045 3939

Email sales1@qprox.com

North America

651 Holiday Drive Bldg. 5 / 300
Pittsburgh, PA 15220
USA

Tel 412-391-7367
Fax 412-291-1015

Copyright © 2004 QRG Ltd
All rights reserved
Patented and patents pending

REV 102.070904