

MODEL:

# PDU3V20D354A

## 3-Phase Power Strip for Automatic Transfer Switch Installations



208V  
3-Phase Input

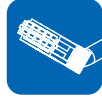

8-Position Plug



208V Single-Phase Output



42 C13 and  
12 C19 Outlets



8.6kW/12.6kW  
Load Capacity



0U  
Rack-Mount



Toolless  
Mounting Buttons

- A** Single-Phase 12A, C13 Outlets
- B** Single-Phase 16A, C19 Outlets
- C** 8-Position Plug with 2.5 ft. Cord
- D** Toolless Mounting Buttons
- E** Chassis Ground Screw
- F** Durable Metal Case

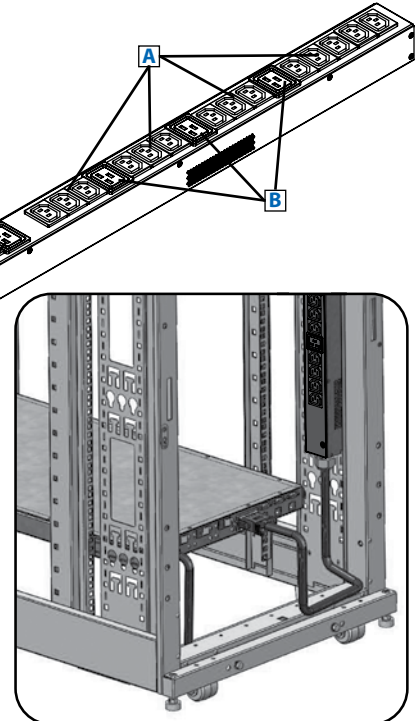
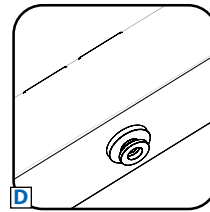

An 8-position plug installs directly to the ATS mating receptacle on the back of the unit.

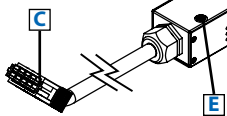

- Vertical power strip distributes power when connected to Tripp Lite ATS PDU models PDU330AT6L21, PDU330AT6L15, PDU330AT6L2130, PDU330AT6L1530 and PDU350AT6H50.
- Supports up to 8.6kW total output with 13.9A maximum per output bank when connected to 208V ATS models with a 24A input rating
- Supports up to 12.6kW total output with 20A maximum per output bank when connected to 208V ATS models with a 35A input rating

**SEE NEXT PAGE FOR DETAILED UNIT MEASUREMENTS**



1111 W. 35th Street  
Chicago, IL 60609 USA  
773.869.1234  
www.tripplite.com



### Specifications

Model	PDU3V20D354A
Voltage	208V (3-Phase Input/Single-Phase Output)
Frequency	50/60 Hz
Load Capacity	8.6 or 12.6kW (depending on ATS PDU model)
Input Plug	8-Position Plug with 7-Conductor Cord
Input Cord Length	2.5 ft. / 0.8 m
Outlets	(x42) C13, (x12) C19
Primary Mounting Options	0U (Vertical) Rack-Mount
Unit Dimensions (H x W x D)	70 x 2.2 x 2.2 in. / 1778 x 56 x 56 mm
Unit Weight	9.3 lb. / 4.2 kg
Standards	Tested to UL 60950-1 (USA), CSA (Canada), NOM (Mexico), FCC Class A (Emissions), ROHS

Tripp Lite has a policy of continuous improvement. Specifications are subject to change without notice.

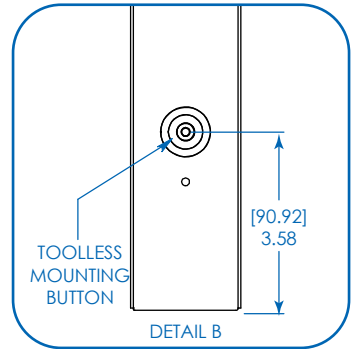
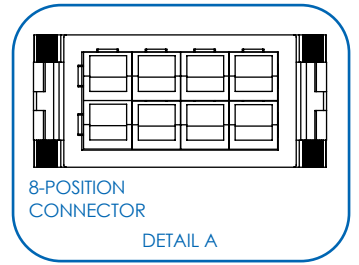
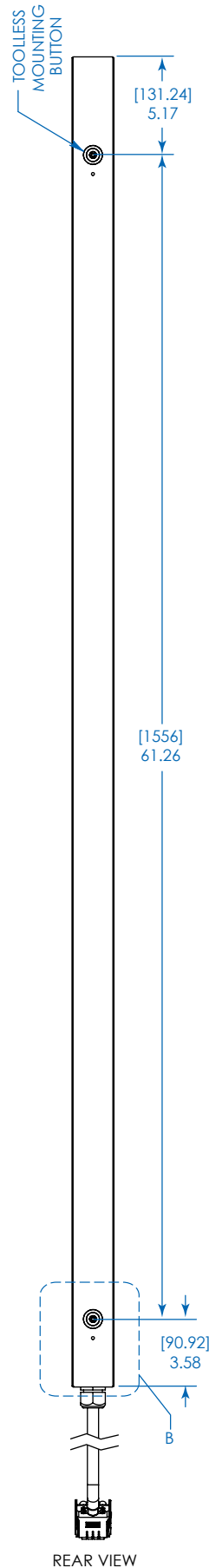
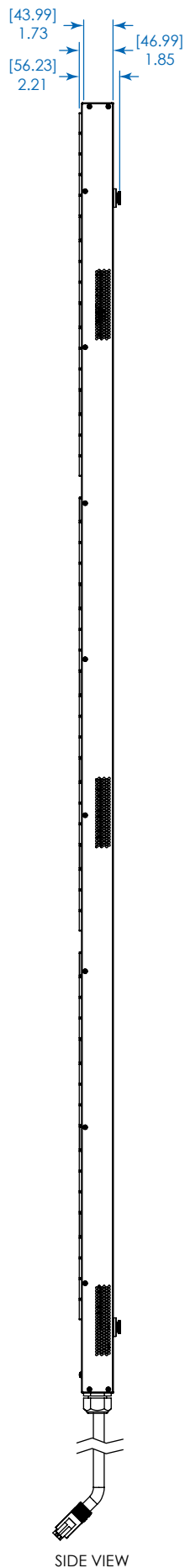
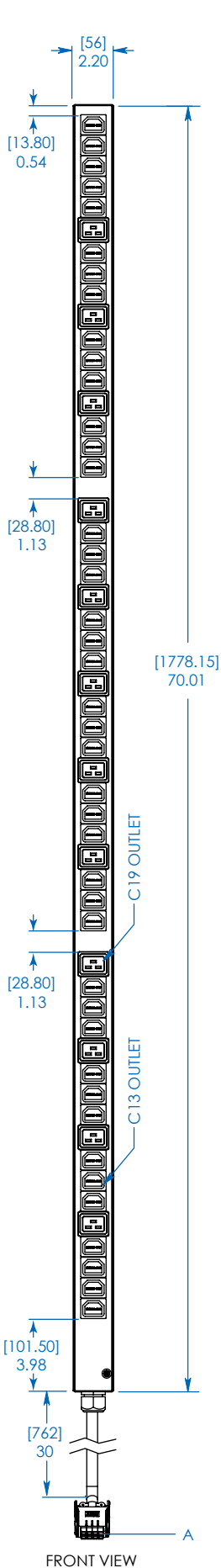

Dimensions: [mm] INCHES

Tripp Lite has a policy of continuous improvement. Specifications are subject to change without notice.

MODEL:  
**PDU3V20D354A**



1111 W. 35th Street  
Chicago, IL 60609 USA  
773.869.1234

[www.tripplite.com](http://www.tripplite.com)