

Mueller Engineered Clips & Insulators

OVER 300 VARIETIES IN-STOCK AND READY FOR IMMEDIATE GLOBAL SHIPMENT



**GUARANTEED
RUGGED,
DURABLE &
RELIABLE**

Mueller's engineered clip designs feature *heavy-gauge* body, spring and rivet materials. Firm springs and sharp teeth yield clips with a strong "bite and hold" Competitive clips typically found in the market are less robust, poorly stamped, and inconsistently assembled. They often have a shorter life, requiring more frequent replacement. *Mueller clips have been tested to 1 million cycles and are designed to last.* No shortcuts or cost-saving tricks are used here. Not all clip insulators are the same. Mueller's insulators are specifically designed to fit the clip. Ill-fitting insulators can lead to electrical shocks or difficult clip operation. Mueller clips are offered in steel (plated with a choice of materials), 100% stainless steel, and copper. Over 300 varieties of clips and insulators are in-stock, and ready for immediate global shipment.

Reference Chart for Popular Clips & Insulator Styles

AMPS	JAW OPENING	WIRE ATTACHMENT	USE WITH INSULATOR	WIRE AWG	PLATING	CLIP NUMBER
5	3/16"	Crimp / Solder	BU-32*	20-24	Nickel	BU-30
5	3/16"	Crimp / Solder	BU-31*	18-24	Nickel	BU-30BL
5	3/16"	Crimp / Solder	BU-32*	20-24	Solid Copper	BU-30C
5	3/16"	Threaded	BU-31*	NA	Nickel	BU-30TBO
5	7/32"	Crimp / Solder	BU-36*	20-24	Nickel	BU-34
5	7/32"	Crimp / Solder	BU-36*	20-24	Copper	BU-34C
5	5/16"	Crimp / Solder	BU-47*	16-22	Zinc	BU-45
5	5/16"	Crimp / Solder	BU-72*	16-20	Nickel	BU-70
5	5/16"	Crimp / Screw	BU-72*	16-20	Nickel	BU-70S
5	5/16"	Crimp / Screw	BU-87*	14-20	Zinc	BU-85
5	1"	Crimp / Screw	JP-8681-*	Up to 10	Nickel / Silver	JP-25182
5	1"	Crimp / Screw	JP-8681-*	Up to 10	Nickel / Silver	JP-33699
5	1"	Crimp / Screw	JP-8681-*	Up to 10	Nickel / Silver	JP-33674
5	1"	Crimp / Screw	JP-8681-*	Up to 10	Nickel / Silver	JP-8078
5	1"	Crimp / Screw	JP-8681-*	Up to 10	Nickel / Silver	JP-8099
5	1"	Crimp / Screw	JP-8681-*	Up to 10	Nickel / Silver	JP-8783
10	1/4"	Crimp / Screw	Insulated	14-20	Nickel	BU-63
10	1/4"	Crimp / Screw	Insulated	14-20	Solid Copper	BU-63C
10	17/64"	Plug-On	Insulated	NA	Nickel	BU-651-*
10	5/16"	Crimp / Screw	BU-47*	16-22	Solid Copper	BU-45C
10	5/16"	Crimp / Solder / Plug-on	BU-62*	14-20	Nickel	BU-60
10	5/16"	Crimp / Solder / Plug-on	BU-62*	14-20	Solid Copper	BU-60C
10	5/16"	Crimp / Screw	Insul. Barrel	14-20	Solid Copper	BU-60CHS
10	5/16"	Crimp / Screw	BU-62*	14-20	Solid Copper	BU-60CS
10	5/16"	Crimp / Solder	Insul. Barrel	14-20	Nickel	BU-60H
10	5/16"	Crimp / Screw	Insul. Barrel	14-20	Nickel	BU-60HS
10	5/16"	Pin / Prod Tip	Insul. Barrel	NA	Nickel	BU-60HPR
10	5/16"	Pin / Prod Tip	BU-62*	NA	Nickel	BU-60PR2
10	5/16"	Crimp / Screw	BU-62*	14-20	Nickel	BU-60S
10	5/16"	Threaded	BU-62*	NA	Nickel	BU-60TBO
10	5/16"	Crimp / Solder	BU-62*	14-20	Nickel	BU-60U
10	5/16"	Crimp / Solder / Plug-On	BU-62*	14-20	Stainless Steel	BU-60X
10	5/16"	Pin / Prod Tip	BU-62*	NA	Nickel	BU-61
10	5/16"	Crimp / Solder	BU-72*	16-20	Copper	BU-70C
10	5/16"	Crimp / Screw	BU-72*	16-20	Copper	BU-70CS
10	5/16"	Screw	Insulated	NA	Gold	BU-75K
10	5/16"	Crimp / Screw	BU-87*	14-20	Solid Copper	BU-85C
10	7/16"	Crimp / Screw	BU-49*	14-20	Zinc	BU-55

AMPS	JAW OPENING	WIRE ATTACHMENT	USE WITH INSULATOR	WIRE AWG	PLATING	CLIP NUMBER
10	7/16"	Crimp / Screw	BU-74*	14-20	Zinc	BU-95
10	1/2"	Crimp / Screw	BU-49*	14-20	Zinc	BU-48B
10	1/2"	Crimp	BU-49*	14-20	Zinc	BU-4882E
10	1/2"	Solder	None	NA	Gold	BU-78K
15	3/4"	Crimp / Solder	Insulated	Up to 12	Nickel	BU-40A-*
20	17/64"	Plug-On	Insulated	NA	Nickel	BU-652-*
20	1/2"	Crimp / Screw	BU-49*	14-20	Solid Copper	BU-48C
20	1/2"	Crimp / Screw	BU-49*	14-18	Solid Copper	BU-50C
20	1/2"	Crimp / Screw	BU-49*	14-18	Solid Copper	BU-51C
20	5/8"	Crimp / Screw	BU-29/90*	Up to 12	Zinc	BU-27
20	5/8"	Crimp / Screw	BU-29/90*	Up to 12	Zinc	JP-5869-B
20	5/8"	Crimp / Screw	BU-29/90*	Up to 12	Zinc	JP-5869-C
20	3/4"	Crimp / Solder	Insulated	Up to 12	Nickel	BU-40C-*
20	1"	Plug-On	Insulated	NA	Nickel	BU-654-*
25	3/4"	Crimp / Screw	BU-26*	Up to 10	Zinc	BU-24APN/APS
30	3/4"	Plug-on	Insulated	NA	Nickel	BU-65-*
30	51/64"	Plug-On	Insulated	NA	Nickel	BU-656-*
40	5/8"	Crimp / Screw	BU-29/90*	Up to 12	Solid Copper	BU-27C
40	5/8"	Crimp / Screw	BU-29/90*	Up to 12	Solid Copper	BU-27CG
40	5/8"	Crimp / Screw	BU-29/90*	Up to 12	Solid Copper	BU-27CGW
40	3/4"	Crimp / Screw	BU-26*	Up to 10	Zinc	BU-25
50	1 1/16"	Crimp / Screw	BU-23*	Up to 8	Zinc	BU-21APN/APS
50	1 1/8"	Crimp / Solder	Insulated	Up to 10	Copper	BU-46A-*
75	3/4"	Crimp / Screw	BU-26*	Up to 10	Solid Copper	BU-25C
75	1 1/8"	Crimp / Solder	Insulated	Up to 10	Solid Copper	BU-46C-*
100	1 1/16"	Lug	BU-23*	Up to 8	Solid Copper	BU-21CPN/CPS
100	1 5/8"	Lug	BU-13*	Up to 3/0	Zinc	BU-11APN/APS
200	1 9/16"	Crimp / Solder	Insulated	Up to 1	Copper	BU-41A-*
200	1 5/8"	Lug	BU-13*	Up to 3/0	Solid Copper	BU-11CPN/CPS
300	1 1/2"	Lug	Insulated	Up to 0	Copper	BU-102B-*
300	1 1/2"	Lug	Insulated	Up to 0	Copper	BU-102BK-*
300	1 13/16"	Lug	BU-35*	Up to 300MCM	Solid Copper	BU-33C
400	1 1/2"	Lug	Insulated	Up to 0	Copper	BU-102W-*
400	1 1/2"	Crimp	Insulated	Up to 1	Copper Jaws	BU-X15400-*
400	1 9/16"	Crimp / Solder	Insulated	Up to 1	Solid Copper	BU-41C-*

TO ORDER PRODUCTS IN VARIOUS LENGTHS & COLORS USE THIS KEY TO PROVIDE THE CORRECT PART NUMBER

BU - 00000 - *
PART NUMBER COLOR

*COLOR KEY:
0=BLACK 2=RED 4=YELLOW
5=GREEN 6=BLUE 9=WHITE



CLIPS & INSULATORS

Mueller clips are the industry standard. Our design reflects 100+ years of innovation and improvement. Mueller clips assure teeth that bite, springs that hold, plating that lasts and insulators that protect.

CLIPS & INSULATORS

Model # BU-30/BU-30C/BU-30X

Miniature Alligator

Solder or crimp connection. Jaw opens 0.188" (4.8 mm) max

Material: nickel-plated steel (BU-30) or solid copper (BU-30C) or 304SS (BU-30X)

Length: 1.1" (27.78mm)

Federal Spec: CID AA59466-001 (BU-30C)

Rating: 5 Amps

Uses insulator BU-32-*

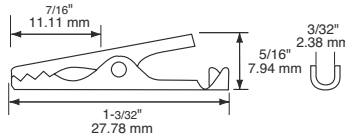

Model # BU-30TBO

Miniature Alligator with Threaded Barrel

6-32 threaded steel barrel connection

Jaw opens 0.188" (4.8 mm) max

Material: nickel-plated steel

Length: 1.5" (38.75mm)

Rating: 5 Amps

Uses insulator BU-31-*

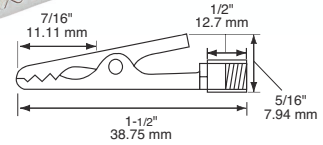

Model # BU-32-*

Insulator for Miniature Alligator

Protective flexible vinyl insulator for 30, 30C, 30X

Material: PVC

Length: 1.63" (41.28mm)

***Std.** -0 Black,

Colors: -2 Red, -4 Yellow, -5 Green, -6 Blue, -9 White

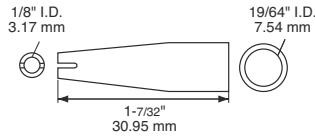

Model # BU-31-*

Insulator for Mini Alligator Barrel/Threaded Barrel

Protective flexible vinyl insulator for 30BL, 30TBO

Material: PVC

Length: 1.63" (41.28mm)

***Std.** -0 Black, -2 Red, -4 Yellow, -5 Green, -6 Blue, -9 White

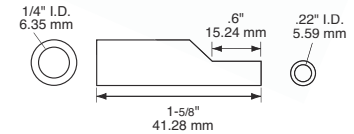

Model # BU-30BL

Miniature Alligator with Barrel

Solder or crimp connection

Jaw opens 0.188" (4.8 mm) max

Material: nickel-plated steel

Length: 1.25" (31.75mm)

Rating: 5 Amps

Uses insulator BU-31-*

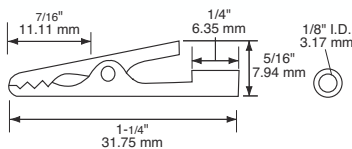

Model # BU-34/BU-34C/BU-34X

Micro-Alligator

Solder or crimp connection

Jaw opens 0.22" (5.6 mm) max

Nose width .07" (1.7 mm)

Material: nickel-plated steel (BU-34) or solid copper (BU-34C) or 304SS (BU-34X)

Length: 1.09" (27.78mm)

Rating: 5 Amps

Uses insulator BU-36-*

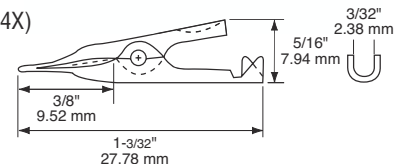



Model # BU-36-*

Insulator for Micro Alligator

Protective flexible vinyl insulator for 34, 34C, 34X

Material: PVC

Length: 1.22" (30.95mm)

- *Std.** -0 Black,
 -2 Red,
 -4 Yellow,
 -5 Green,
 -6 Blue,
 -9 White



Model # BU-60PR2

Probe Tip Alligator Clip

Accepts standard .080" (2mm) probe tip or test probe tip

Jaw opens 0.31" (7.9 mm) max

Material: nickel-plated steel

Length: 1.97" (50mm)

Rating: 10 Amps

Use insulator BU-62-* or BU-72-*

Also available is Model #BU-60PR1 which accepts a .125" (3.1mm) Probe

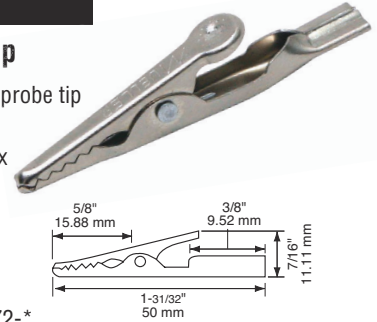

Model # BU-60/BU-60C/BU-60X

Alligator Clip with Barrel

Compatible with all shrouded, unshrouded, or retractable 0.16" (4mm) banana plugs

Solder or crimp connection

Jaw opens 0.31" (7.9 mm) max

Material: nickel-plated steel (BU-60), solid copper (BU-60C), 304 stainless steel (BU-60X)

Length: 1.97" (50mm)

Rating: 10 Amps

Uses insulator BU-62-* or BU-72-*

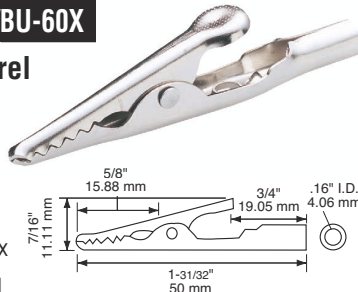

Model # BU-60TBO

Threaded Barrel Alligator Clip

8-32 threaded barrel connection

Jaw opens 0.31" (7.9 mm) max

Material: nickel-plated steel

Length: 2.13" (53.97mm)

Rating: 10 Amps

Uses insulator BU-62-* or BU-72-*

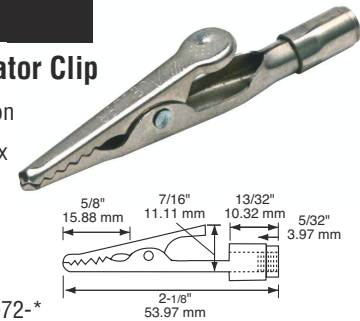

Model # BU-60S/BU-60CS*

Alligator Clip with Screw

Compatible with all shrouded, unshrouded, or retractable 0.16" (4mm) banana plugs

6-40 screw connection

Jaw opens 0.31" (7.9 mm) max

Material: nickel-plated steel (BU-60S) or solid copper (BU-60CS)

Length: 1.97" (50mm)

Federal Spec CID AA59466-002 (BU-60CS)

Rating: 10 Amps

Uses insulator BU-62-* or BU-72-*

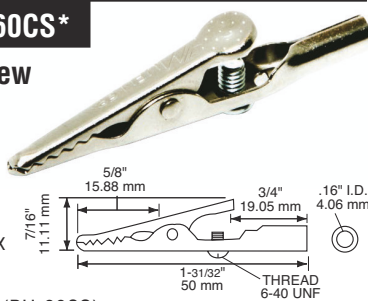

Model # BU-60U

Alligator Clip

Solder or crimp connection

Jaw opens 0.31" (7.9 mm) max

Material: nickel-plated steel

Length: 1.97" (50mm)

Rating: 10 Amps

Uses insulator BU-62-* or BU-72-*

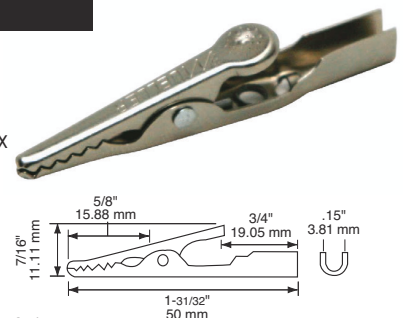



CLIPS & INSULATORS

Color Key

0 Black	2 Red	4 Yellow
5 Green	6 Blue	9 White

CLIPS & INSULATORS

Model # BU-61

Alligator Clip with Cage Spring Barrel

Cage spring connection accepts standard probe needle (0.080 dia.)
Jaw opens 0.31" (7.9 mm) max

Material: nickel-plated steel clip, nickel-plated brass insert, gold plated beryllium copper cage spring

Length: 2.03" (51.59mm)

Rating: 10 Amps

Uses insulator BU-62-* or BU-72-*

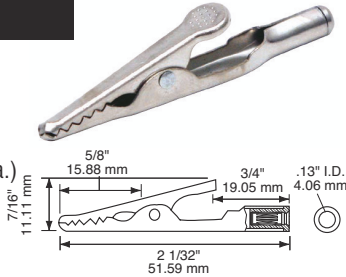

Model # BU-60HS-*/BU-60CHS-*

Alligator Clip with Acetate Handle and Screw

Compatible with all unshrouded, or retractable 0.16" (4mm) banana plugs
Jaw opens 0.31" (7.9 mm) max

Material: (BU-60HS-*) nickel-plated steel or (BU-60CHS-*) solid copper clip

Length: 2.34" (59.53mm)

***Std.** -0 Black, -2 Red,

Colors: -4 Yellow, -5 Green, -6 Blue, -9 White

Federal AA59466-003 (red), (BU-6CHS-2)

Spec: AA59466-016 (black), (BU-60CHS-0)

Rating: 10 Amps

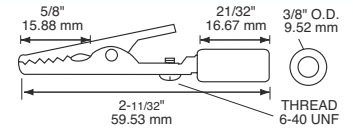

Model # BU-62-*

Insulator for Alligator Clips

Protective flexible vinyl insulator for 60, 60C, 60CS, 60PR2, 60S, 60TBO, 60U, 60X and 61

Material: PVC

Length: 2.03" (51.59mm)

***Std.** -0 Black,

Colors: -2 Red, -4 Yellow, -5 Green, -6 Blue, -9 White

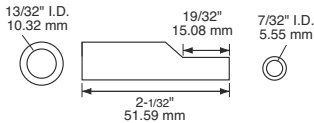

Model # BU-60HPR-*

Probe Tip Alligator Clip with Acetate Handle

Accepts standard probe tip or test probe tip

Material: nickel-plated steel clip

Length: 2.23" (56.75mm)

***Std.** -0 Black, -2 Red,

Colors: -4 Yellow, -5 Green, -6 Blue, -9 White

Rating: 10 Amps

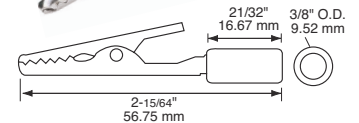

Model # BU-60H-*

Alligator Clip with Acetate Handle

Compatible with all unshrouded, or retractable 0.16" (4mm) banana plugs

Jaw opens 0.31" (7.9 mm) max

Material: nickel-plated steel clip;

Length: 2.23" (56.75mm)

***Std.** -0 Black,

Colors: -2 Red, -4 Yellow, -5 Green, -6 Blue, -9 White

Rating: 10 Amps

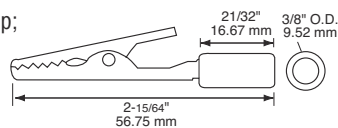

Model # BU-63-*/BU-63C-*

Insulated Alligator Clip

BU-63-* same as BU-60S and includes a skin-tight, two-piece, flexible insulator
BU-63C-* same as BU-60CS and includes a skin-tight, two piece, flexible insulator

Compatible with all shrouded, unshrouded, or retractable 0.16" (4mm) banana plugs

Material: nickel-plated steel (BU-63-*) or solid copper (BU-63C-*)

Length: 2.25" (57.15mm)

***Std.** -0 Black, -2 Red,

Colors: -4 Yellow, -5 Green, -6 Blue, -9 White

Rating: 10 Amps

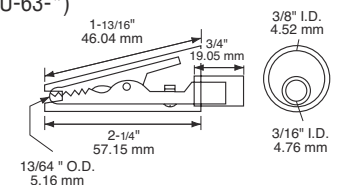



Model # BU-70/BU-70C

Alligator Clip

Solder or crimp connection
Jaw opens 0.313" (7.9 mm) max

Material: nickel-plated steel (BU-70) or solid copper (BU-70C)

Length: 1.69" (42.86mm)

Rating: 5 Amps (BU-70) or 10 Amps (BU-70C)

Uses insulator BU-72-*

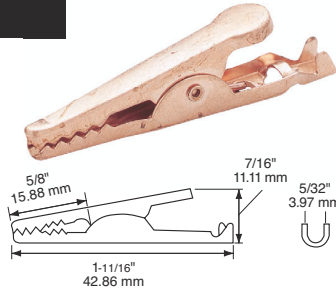

Model # BU-85/BU-85C

Crocodile Clip

Crimp or screw connection
Jaw opens 0.313" (7.9 mm) max
Nesting teeth provide solid contact along entire length of jaw

Material: (BU-85) zinc-plated steel or (BU-85C) solid copper

Length: 2.125" (53.97mm)

Federal Spec: AA59466-005 (BU-85C)

Rating: 5 Amps (BU-85) or 10 Amps (BU-85C)

Uses insulator BU-87-*

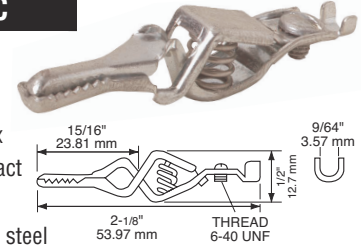

Model # BU-70S/BU-70CS

Alligator Clip with Screw

6-40 screw or crimp connection
Jaw opens 0.313" (7.9 mm) max

Material: (BU-70S) nickel-plated steel or (BU-70CS) solid copper

Length: 1.69" (42.86mm)

Federal Spec: AA59466-0017 (BU-70CS)

Rating: 5 Amps (BU-70S) or 10 Amps (BU-70CS)

Uses insulator BU-72-*

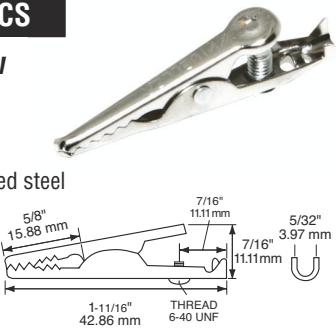

Model # BU-87-*

Insulator for Crocodile Clip

Protective flexible vinyl insulator for 85, 85C

Material: PVC

Length: 1.7" (43.26mm)

***Std.** -0 Black,
Colors: -2 Red, -4 Yellow,
-5 Green, -6 Blue,
-9 White

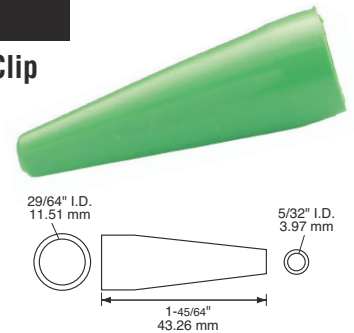

Model # BU-72-*

Insulator for Alligator Clip

Protective flexible vinyl insulator for 70, 70C, 70CS, 70S, 60, 60C, 60S, 60CS, 60X

Material: PVC

Length: 1.81" (46.04mm)

***Std.** -0 Black,
Colors: -2 Red, -4 Yellow,
-5 Green, -6 Blue,
-9 White

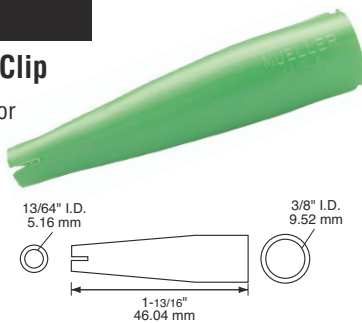

Model # BU-651-*

Small Safety Alligator Clip

Compatible with all unshrouded, or retractable 0.16" (4mm) banana plugs
Jaw opens 0.27" (7 mm) max

Material: nickel-plated steel clip, glass-filled nylon housing

Length: 2.24" (57mm)

***Std.** -0 Black,
Colors: -2 Red

Rating: 300 V Category II or 150 Category III
10 Amps, IEC 1010 Compliant

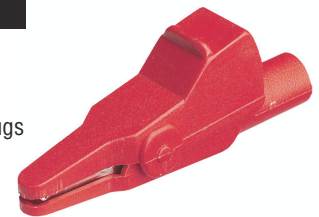



CLIPS & INSULATORS

Color Key

0 Black	2 Red	4 Yellow
5 Green	6 Blue	9 White

CLIPS & INSULATORS

Model # BU-652-*

Small Safety Alligator Clip with Extended Banana Jack

Compatible with all shrouded, unshrouded, or retractable 0.16" (4mm) banana plugs

Jaw opens 0.27" (7 mm) max

Material: nickel-plated steel clip, glass-filled nylon housing

Length: 3.24" (82mm)

***Std. Colors** -0 Black, -2 Red

Rating: 300 V Category II, or 150 V Category III, 20 Amps, IEC 1010 Compliant



Model # BU-45/BU-45C

Pee-Wee Clip

Screw or crimp connection

Jaw opens 0.31" (7.9 mm) max

Material: (BU-45) zinc-plated steel or (BU-45C) solid copper

Length: 1.53" (38.89mm)

Federal CID AA59466-006

Spec: (BU-45C)

Rating: 5 Amps (BU-45) or 10 Amps (BU-45C)

Uses insulator BU-47-*

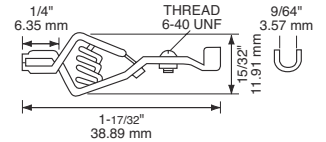

Model # BU-65-*

Large Safety Alligator Clip

Compatible with all shrouded, unshrouded, or retractable 0.16" (4mm) banana plugs

Jaw opens 0.75" (19 mm) max

Material: nickel-plated steel clip, glass-filled nylon housing

Length: 3.23" (82.04mm)

***Std.** -0 Black,

Colors: -2 Red, -4 Yellow, -5 Green, -6 Blue

Rating: 1000 V, 30 Amps, IEC 1010 Compliant UL Listed



Model # BU-47-*

Insulator for Pee-Wee Clip

Protective flexible vinyl insulator for 45, 45C

Material: PVC

Length: 2.02" (51.2 mm)

***Std.** -0 Black,

-2 Red, -4 Yellow, -5 Green, -6 Blue, -9 White

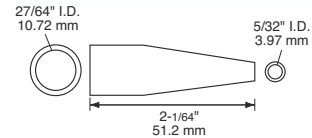

Model # BU-110-*

Fully Insulated Mini Clip

Compatible with all shrouded, unshrouded, or retractable .016" (4mm) banana plugs. Jaw opens 0.31" (7.9mm)

Material: Nickel plated steel & nylon

Length: 1.65" (42mm)

***Std. Colors:** -0 Black, -2 Red

Rating: 300V, 6 Amps



Model # BU-55

Economy Clip

Screw or crimp connection

Jaw opens 0.44" (11.1 mm) max

Material: zinc-plated steel

Length: 2" (50.8mm)

Rating: 10 Amps

Uses insulator BU-49-*

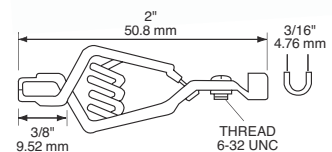



Model # BU-50C

Meter Testing Clip with Needle

Has a solid beryllium copper piercing needle in the top jaw. Jaw opens .5" (12.5mm)

Excellent for quick connection to insulated wire.

- Material:** Solid Copper
- Length:** 2.28" (57.12mm)
- Rating:** 20 Amps
- Uses insulator BU-49-*

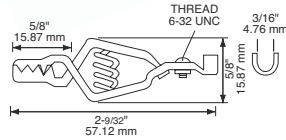

Model # BU-51C

Meter Testing Clip

Same as BU-50C except without insulation piercing needle. Jaw opens 0.5" (12.7 mm) max

- Material:** Solid copper
- Length:** 2.28" (57.12mm)
- Rating:** 20 Amps
- Uses insulator BU-49-*

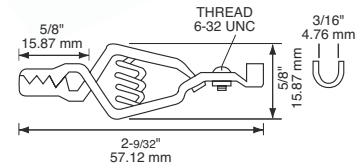

Model # BU-48B/BU-48C

Automotive Analyzer Clip

Screw or crimp connection. Jaw opens 0.5" (12.7 mm) max. Teeth mesh on three sides of the jaw

Material: (BU-48B) zinc-plated steel or (BU-48C) solid copper

- Length:** 2" (50.8mm)
- Federal Spec:** CID AA59466-007 (BU-48C)
- Rating:** 10 Amps (BU-48B) or 20 Amps (BU-48C)

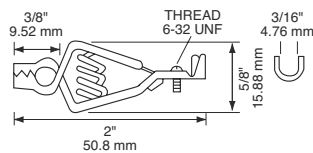

Model # BU-49-*

Insulator for Automotive Analyzer Clip

Protective flexible vinyl insulator for 48B, 48B2E, 48C, 50C, 51C, 55, 95

- Material:** PVC
- Length:** 2.56" (65.09mm)
- *Std. Colors:**
 - 0 Black,
 - 2 Red,
 - 4 Yellow,
 - 5 Green,
 - 6 Blue,
 - 9 White

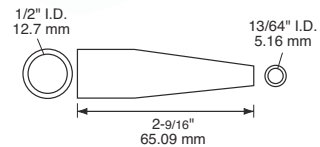

Model # BU-48B2E

Automotive Analyzer Clip

Double crimp connection. Jaw opens 0.5" (12.7 mm) max

- Material:** zinc-plated steel
- Length:** 2" (50.8mm)
- Rating:** 10 Amps
- Uses insulator BU-49-*

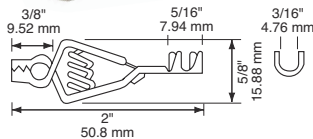

Model # BU-27/BU-27C

General Purpose Clip

Crimp or screw connection; Jaw opens 0.625" (16 mm) max

- Material:** (BU-27) zinc-plated steel or (BU-27C) solid copper
- Length:** 2.44" (61.9mm)
- Federal Spec:** CID AA59466-008 (BU-27C)
- Rating:** 20 Amps (BU-27) or 40 Amps (BU-27C)
- Uses insulator BU-29-* or BU-90-*

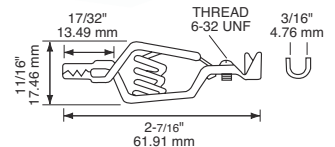



CLIPS & INSULATORS

Color Key

0 Black	2 Red	4 Yellow
5 Green	6 Blue	9 White

CLIPS & INSULATORS

Model # BU-27CG/BU-27CGW

Geophone Clip

Crimp or screw connection;
Jaw opens 0.625" (16 mm) max;
Curved jaws clip on to
seismograph rings

Material: solid copper;
Spring: steel

Length: 2.4" (61.1mm)

Rating: 40 Amps

Uses insulator BU-29-*
or BU-90-*

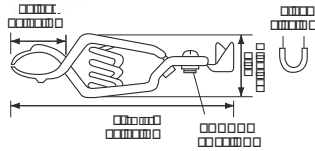

Model # BU-24APN/BU-24APS

Heavy Duty Clip

Crimp or screw connection; Jaw
opens 0.75" (19 mm) max; clip
unmarked (BU-24APN) and
marked positive (BU-24APS)

Material: zinc-plated steel;
Spring: steel

Length: 2.84" (72.23mm)

Rating: 25 Amps

Uses insulator BU-26-*

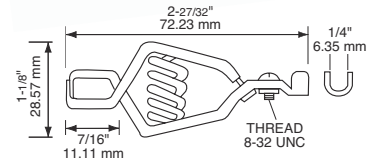

Model # BU-29-*

Insulator for General Purpose/Geophone Clips

Protective flexible vinyl insulator for
27, 27C, 27CG, 27CGW

Material: PVC

Length: 3.5" (88.9mm)

***Std.** -0 Black,

Colors: -2 Red,
-4 Yellow, -5 Green,
-6 Blue, -9 White



Model # BU-25/BU-25C

Automotive Clip

Crimp or screw connection; Jaw
opens 0.75" (19 mm) max; teeth
mesh on three sides of the jaw

Material: zinc-plated steel (BU-25)
or solid copper (BU-25C);
Spring: steel

Length: 3" (76.2mm)

Federal Spec: CID AA59466-009
(BU-25C)

Rating: 40 Amps (BU-25) or 75 Amps (BU-25C)

Uses insulator BU-26-*

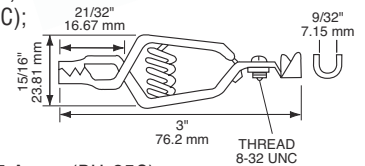
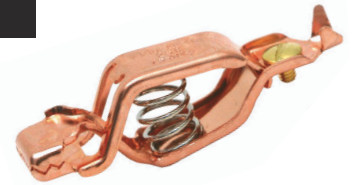

Model # BU-90-*

Insulator for General Purpose/Geophone Clips

Protective flexible vinyl insulator for
27, 27C, 27CG and 27CGW

Accepts larger wires or cables
than BU-29-*

Material: PVC

Length: 3.375" (92mm)

***Std.** -0 Black,

Colors: -2 Red,
-4 Yellow, -5 Green,
-6 Blue, -9 White

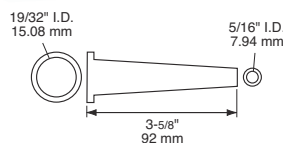

Model # BU-26-*

Insulator for Automotive Clip

Protective flexible vinyl insulator for
24A, 25, 25C

Material: PVC

Length: 3.88" (98.4 mm)

***Std.** -0 Black,

Colors: -2 Red,
-4 Yellow,
-5 Green,
-6 Blue, -9 White

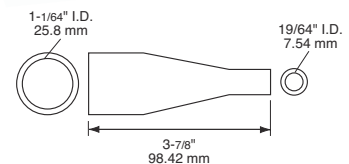



Model # BU-21APN/BU-21APS/BU-21CPN/BU-21CPS

Heavy Duty Clip for Battery and Test Work

Crimp or screw connection; copper version (21C) equipped with removable copper lug; Jaw opens 1.06" (27 mm) max; clip unmarked (BU-21APN/CPN) and marked positive (BU-21APS/CPS)

Material: zinc-plated steel (21A) or solid copper (21C); Spring: steel

Length: 4.11" (104.4mm)

Federal Spec: CID AA59466-010 (BU-21CPN)

Rating: 50 Amps (21A) or 100 Amps (21C)

Uses insulator BU-23-*

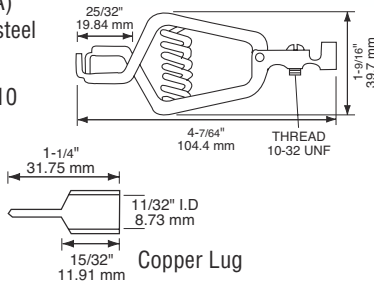

Model # BU-13-*

Insulator for Heavy Duty Clip

Protective flexible vinyl insulator for 11A, 11C

Material: PVC

Length: 6.8" (173mm)

***Std.** -0 Black, -2 Red,

-4 Yellow, -5 Green,

-6 Blue, -9 White



Model # BU-33C

Welding Clip "BIG BRUTE"

Lug connection

Jaw opens 1.81" (46 mm) max

Material: solid copper

Length: 7.75" (196.8mm)

Federal Spec: CID AA59466-012

Rating: 300 Amps

Uses insulator BU-35-*

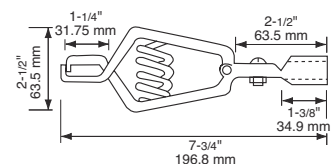
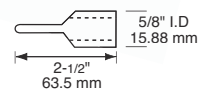

Model # BU-23-*

Insulator for Heavy Duty Battery Test Clip

Protective flexible vinyl insulator for 21A, 21C

Material: PVC

Length: 5" (127mm)

***Std.** -0 Black,

-2 Red,

-4 Yellow,

-5 Green,

-6 Blue, -9 White

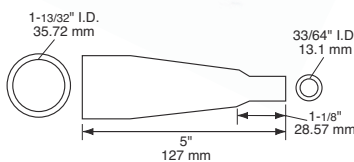

Model # BU-11APN/BU-11APS/BU-11CPN/BU-11CPS

Heavy Duty Clip for Grounding Applications

BU-11 series clips have a lug connection

Jaw opens 1.625" (41.3 mm) max

Clip unmarked (BU-11APN/CPN) and marked positive (BU-11APS/CPS)

Material: zinc-plated steel (11A) or solid copper (11C); Spring: steel

Length: 6" (152.4 mm)

Federal Spec: CID AA59466-011 (BU-11CPN)

Rating: 100 Amps (11A) or 200 Amps (11C)

Uses insulator BU-13-*

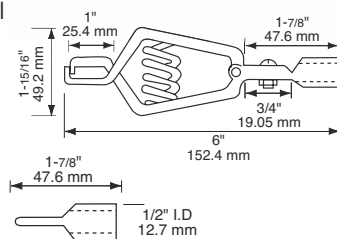

Model # BU-35-*

Insulator for Welding Clip

Protective flexible vinyl insulator for 33C

Material: PVC

Length: 8.75" (222mm)

***Std.** -0 Black,

-2 Red,

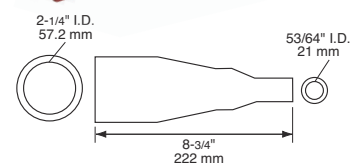



CLIPS & INSULATORS

Color Key

0	Black	2	Red	4	Yellow
5	Green	6	Blue	9	White

CLIPS & INSULATORS

Model # BU-58

Grounding Clamp

Attaches to pipe up to 1 3/8" outer diameter

Material: zinc-plated steel
Length: 2.31" (58.75mm)
Rating: 50 Amps



Model # BU-46PR-*

Insulator for Miniature Plier-Type Clip

Protective flexible vinyl insulator for BU-46

Material: PVC
Length: 1.7" (43.18mm)
***Std.** -0 Black,
Colors: -2 Red,

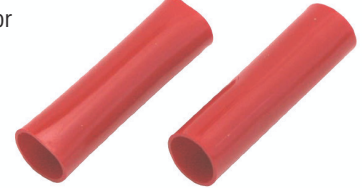

Model # BU-40A-*/BU-40C-*

Micro Plier-Type Clip

Solder or crimp connection
 Jaw opens 0.75" (19 mm) max

Material: (BU-40A) nickel-plated steel or (BU-40C) solid copper
Length: 2.3" (58mm)
***Std.** -0 Black,
Colors: -2 Red,
Rating: 15 Amps (BU-40A), 20 Amps (BU-40C)



Model # BU-41A-*/BU-41APN/BU-41C-*/BU-41CPN

Plier-Type Clip

Jaw opens 1.625" (41.3 mm) max
 Locks on to both side and top mounted battery terminals

Material: copper-plated steel (BU-41A) or solid copper (BU-41C), PVC insulator (BU-43PR-*)

Length: 6" (152mm)
***Std.** Insulator (BU-43PR-*)
Colors: in -0 Black, -2 Red, -4 Yellow, -5 Green, -6 Blue, -9 White

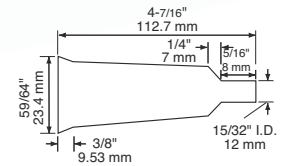

Federal Spec: CID AA59466-014 BU-41-CPS-VZZZ-2 (red) and CID AA59466-015, BU-41CPN-VZZZ-0 (black)

Rating: 200 Amps (41A) or 400 Amps (41C)

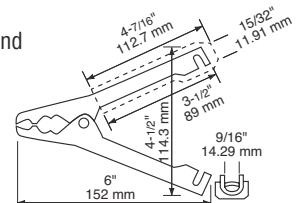

Model # BU-46A-*/BU-46C-*/BU-46X

Miniature Plier-Type Clip

Solder or crimp connection
 Jaw opens 1.125" (28.6 mm) max

Material: copper-plated steel (BU-46A) or solid copper (BU-46C), 304SS (BU-46X) PVC insulator (BU-46PR-*)

Length: 2.88" (98.42mm)
***Std.** Insulator (BU-46PR-*)
Colors: in -0 Black, -2 Red
Rating: 50 Amps (46A) or 75 Amps (46C)

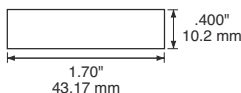
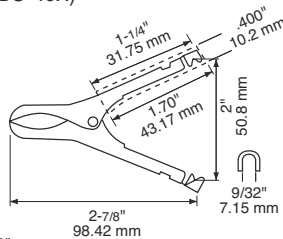
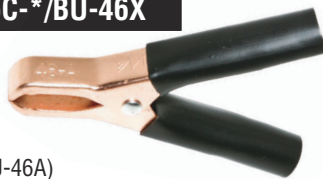

Model # BU-43PR-*

Insulator Pair for Plier-Type Clip

Protective flexible vinyl insulator for BU-41

Material: PVC
Length: 4.4" (112.73mm)
***Std.** -0 Black,
Colors: -2 Red, -4 Yellow, -5 Green, -6 Blue, -9 White





Model # BU-102B-*/BU-102BK-*

Insulated Battery Clip

Solder lug connection. Fully insulated clip with serrated jaws; BU-102BK-* has Kelvinized isolated jaws and no copper shunt

Material: Housing: glass filled nylon;
Jaw: copper; Spring: music wire, zinc plated

Length: 6.5" (165mm)

***Std.** -0 Black,

Colors: -2 Red

Rating: 300 Amps



Model # BU-75K

Kelvin Clip

Screw connection. Jaw opens 0.313" (7.9 mm) max. Isolated jaws

Material: Silver/Gold tip contacts, nylon housing

Length: 1.625" (41.28mm)

Rating: 10 Amps

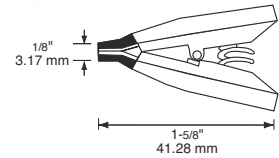

Model # BU-102W-*

Insulated Welding Clip

Solder lug connection. Fully insulated clip with serrated contact pad and braided copper shunt

Material: Housing: glass filled nylon;
Jaw: copper;
Spring: music wire, zinc plated

Length: 6.5" (165mm)

***Std.** -0 Black,

Colors: -2 Red

Rating: 400 Amps



Model # BU-78K

Kelvin Clip

Solder connection. Jaw opens 0.5" (12 mm) max. Isolated jaws

Material: Gold contacts

Length: 2.28" (57.91mm)

Rating: 10 Amps

Wires run through channel in thimbal and solder into holes under the silicone spring.

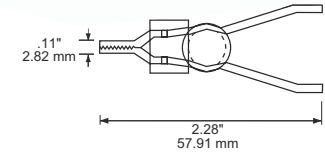

Model # BU-X15400-*

Epoxy Coated Battery Clip

Solder/crimp connection. Jaw opens 1.50" (38.1 mm) max. Locks on to both side and top mounted battery terminals

Material: steel, epoxy coated clips with copper plated jaws

Length: 6.75" (171.45mm)

***Std. Colors:** -0 Black, -2 Red

Rating: 200 Amps



Model # BU-P2240-*

Alligator Clip & Insulator, (10 Pack)

Ten Each of BU-60 Alligator Clips and BU-62-* Insulators in a convenient bag

***Std. Colors:** -0 Black, -2 Red,





CLIPS & INSULATORS

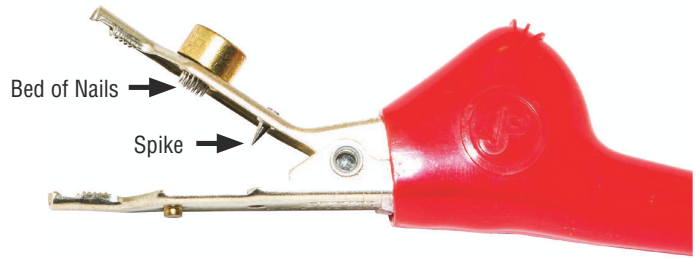

CLIPS & INSULATORS

Model # JP-25182-***

Small Angled Nose Telecom Clip with Bed of Nails

Mueller – J.S. Popper brand.
Jaw opens 1.0" (25.4mm).
Uses bed of nails to pierce insulation

Material: nickel-silver jaws; includes brass screw, brass nut, brass washer, and bronze star washer

Length: 2.34" (59.4mm)

Connection -N Without Hardware, -L With Loose Hardware,
Options: -J Banana Jack, -TJ Threaded Banana Jack
-S Nickel plated steel version of clip

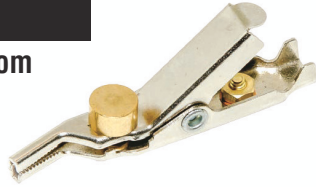

Model # JP-8783-***

Large Angled Nose Telecom Clip with Bed of Nails and Single Spike

Mueller – J.S. Popper brand. Jaw opens 1.0" (25.4mm). Uses single spike and bed of nails to pierce insulation

Material: nickel-silver jaws; includes brass screw, brass nut, brass washer, and bronze star washer

Length: 2.61" (66.4mm)

Connection -N Without Hardware, -L With Loose Hardware,
Options: -J Banana Jack, -TJ Threaded Banana Jack
-S Nickel plated steel version of clip



Model # JP-8099-***

Large Angled Nose Telecom Clip with Single Spike

Mueller – J.S. Popper brand
Jaw opens 1.0" (25.4mm)
Uses single spike to pierce insulation

Material: nickel-silver jaws; includes brass screw, brass nut, brass washer, and bronze star washer

Length: 2.34" (59.4mm)

Connection -N Without Hardware, -L With Loose Hardware,
Options: -J Banana Jack, -TJ Threaded Banana Jack



Model # JP-33699-***

Large Straight Nose Telecom Clip with Single Spike

Mueller – J.S. Popper brand. Jaw opens 1.0" (25.4mm)
Uses single spike to pierce insulation

Material: nickel-silver jaws; includes brass screw, brass nut, brass washer, and bronze star washer

Length: 2.61" (66.4mm)

Connection -N Without Hardware, -L With Loose Hardware,
Options: -J Banana Jack, -TJ Threaded Banana Jack



Model # JP-33674-***

Large Straight Nose Telecom Clip with Bed of Nails and Single Spike

Mueller – J.S. Popper brand. Jaw opens 1.0" (25.4mm) Uses single spike and bed of nails to pierce insulation

Material: nickel-silver jaws; includes brass screw, brass nut, brass washer, and bronze star washer

Length: 2.61" (66.4mm)

Connection -N Without Hardware, -L With Loose Hardware,
Options: -J Banana Jack, -TJ Threaded Banana Jack



Model # JP-8078-***

Large Angled Nose Telecom Clip with Hex Screw Attached Single Spike

Mueller – J.S. Popper brand
Jaw opens 1.0" (25.4mm)
Uses single spike to pierce insulation

Material: nickel-silver jaws; includes brass screw, brass nut, brass washer, and bronze star washer

Length: 2.34" (59.4mm)

Connection -N Without Hardware, -L With Loose Hardware,
Options: -J Banana Jack, -TJ Threaded Banana Jack



Model # JP-5869-B

Contact Clip with Bed of Nails

Mueller – J.S. Popper brand
Jaw opens 0.52" (13.2mm)
Uses bed of nails to pierce insulation

Material: Steel

Length: 2.4" (61.0mm)





Model # JP-8681-*

Insulator for Telecom Clips

Mueller – J.S. Popper brand
 Protective flexible vinyl insulator
 for 25182, 8099, 8078,
 8783, 33699, 33674

- Material:** PVC
Length: 2.4" (61.0mm)
***Std.** -0 Black,
 -2 Red,
 -4 Yellow,
 -5 Green,
 -6 Blue,
 -9 White

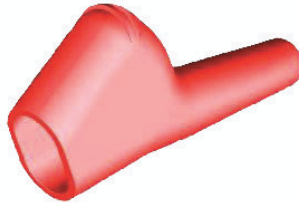

Model # JP-8681-C*

Cut Insulator for Telecom Clips

Mueller – J.S. Popper brand
 Protective flexible vinyl insulator for
 telecom clips with banana jack
 or threaded banana jack
 connections

- Material:** PVC
Length: 1.8" (45.7mm)
***Std.** -0 Black,
 -2 Red,
 -4 Yellow,
 -5 Green,
 -6 Blue,
 -9 White

