

MASSE OHNE TOLERANZ SIND KEINE PRUEFMASSE
 DIMS. WITHOUT TOLERANCE ARE NOT CONTROL DIMS.

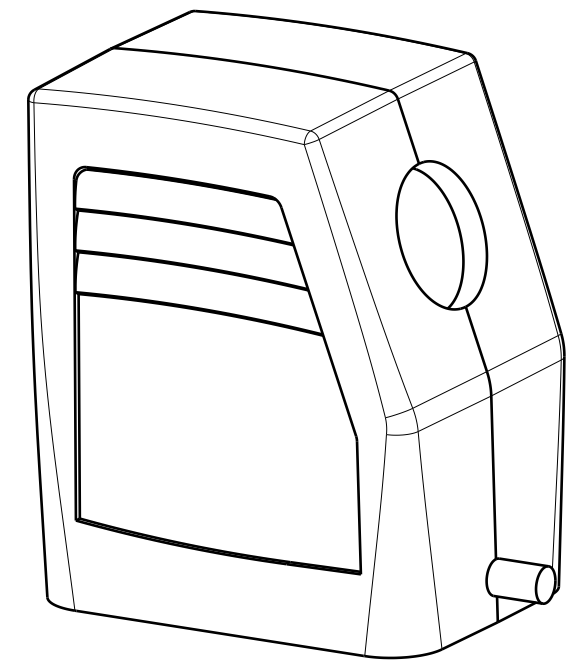
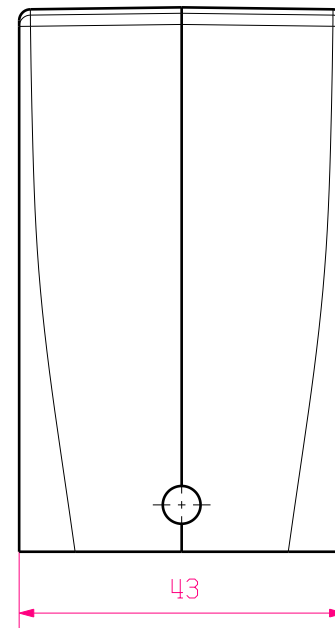
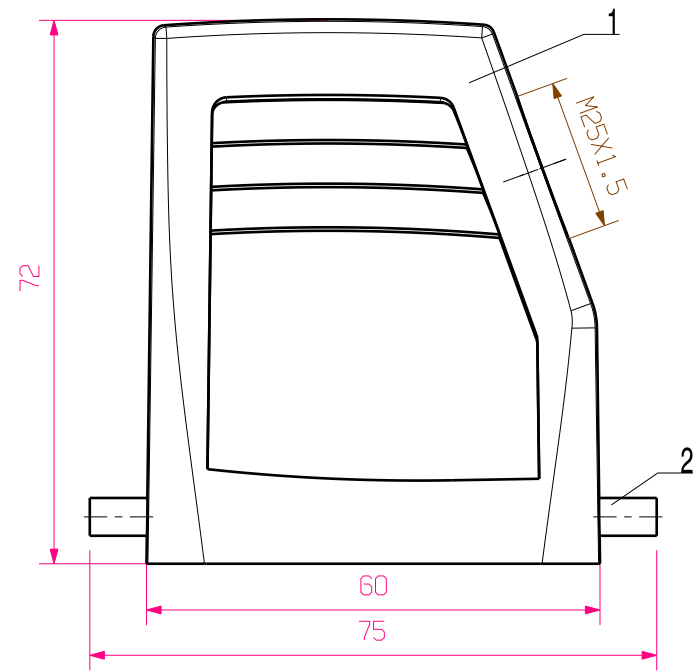

2	LOCKING BOLTS	STAINLESS STEEL
1	PLUG HOOD HOUSING	ALUMINIUM WITH POWDER COATING
ROHSTOFF-NR. R.PART NO.	TYP PART NAME	WERKSTOFF MATERIAL

		CAT.NO.: 1787480000	
MAX. NRN./NOS. ?		Weidmüller	
MODIFICATION		DRAWING NO.	ISSUE NO.
	DATE	NAME	
SCALE: 1/1	DRAWN 14.11.2005	LIU_F	
SUPERSEDES:	CHECKED 30.11.2005	ZHANG_T	
SUPERSEDED BY:	APPROVED		
		HDC 16D TSLU 1M25G STECKERGEHAEUSE PLUG HOOD HOUSING	
		PRODUCT FILE:	

WEITERGABE SOWIE VERVIELFÄLTIGUNG DIESES DOKUMENTS, VERWERTUNG UND MITTEILUNG SEINES INHALTS SIND VERBOTEN, SOWEIT NICHT AUSDRUECKLICH GESTATET.
 ZUWIDERHANDLUNGEN VERPFLICHTEN ZU SCHADENERSATZ. ALLE RECHTE FUER DEN FALL DER PATENT-, GEBRAUCHSMUSTER- ODER GESCHMACKSMUSTEREINTRAGUNG VORBEHALTEN.
 THE REPRODUCTION, DISTRIBUTION AND UTILIZATION OF THIS DOCUMENT AS WELL AS THE COMMUNICATION OF ITS CONTENTS TO OTHERS WITHOUT EXPLICIT AUTHORIZATION IS PROHIBITED.
 OFFENDERS WILL BE HELD LIABLE FOR THE PAYMENT OF DAMAGES. ALL RIGHTS RESERVED IN THE EVENT OF THE GRANT OF A PATENT, UTILITY MODEL OR DESIGN.