



LCD0821
Technical Manual

Revision: 2.1

Contents

Contents	ii
1 Getting Started	1
1.1 Display Options Available	1
1.2 Accessories	2
1.3 Features	3
1.4 Connecting to a PC	4
1.5 Installing the Software	5
1.5.1 uProject	5
2 Hardware Information	6
2.1 Power/Data Connector	6
2.2 RS-232 Header	7
2.3 Manual Override	7
2.4 General Purpose Output	8
2.5 Protocol Select Jumpers	9
3 Troubleshooting	10
3.1 The display does not turn on when power is applied.	10
3.2 The display module is not communicating.	10
3.3 The display module is communicating, however text cannot be displayed.	11
4 Communications	11
4.1 Introduction	11
4.1.1 I ² C Communication Summary	11
4.1.2 I ² C Transaction Example	12
4.1.3 Serial Communication	13
4.2 Changing the I ² C Slave Address	13
4.3 Changing the Baud Rate	13
4.4 Setting a Non-Standard Baud Rate	14
5 Text	15
5.1 Introduction	15
5.1.1 Character Set	16
5.1.2 Control Characters	17
5.2 Auto Scroll On	18
5.3 Auto Scroll Off	18
5.4 Clear Screen	18
5.5 Changing the Startup Screen	18
5.6 Set Auto Line Wrap On	19
5.7 Set Auto Line Wrap Off	19
5.8 Set Cursor Position	19
5.9 Go Home	20
5.10 Move Cursor Back	20

5.11	Move Cursor Forward	20
5.12	Underline Cursor On	21
5.13	Underline Cursor Off	21
5.14	Blinking Block Cursor On	21
5.15	Blinking Block Cursor Off	21
6	Special Characters	22
6.1	Introduction	22
6.2	Creating a Custom Character	22
6.3	Saving Custom Characters	23
6.4	Loading Custom Characters	24
6.5	Save Startup Screen Custom Characters	24
6.6	Initialize Medium Number	25
6.7	Place Medium Numbers	25
6.8	Initialize Horizontal Bar	26
6.9	Place Horizontal Bar Graph	26
6.10	Initialize Narrow Vertical Bar	26
6.11	Initialize Wide Vertical Bar	27
6.12	Place Vertical Bar	27
7	General Purpose Output	28
7.1	Introduction	28
7.2	General Purpose Output Off	28
7.3	General Purpose Output On	28
7.4	Set Startup GPO state	29
8	Display Functions	29
8.1	Introduction	29
8.2	Display On	29
8.3	Display Off	30
8.4	Set Brightness	30
8.5	Set and Save Brightness	30
8.6	Set Contrast	31
8.7	Set and Save Contrast	31
9	Data Security	32
9.1	Introduction	32
9.2	Set Remember	32
9.3	Data Lock	33
9.4	Set and Save Data Lock	34
9.5	Write Customer Data	35
9.6	Read Customer Data	35
10	Miscellaneous	35
10.1	Introduction	35
10.2	Read Version Number	35
10.3	Read Module Type	36

11 Command Summary	38
11.1 Communications	38
11.2 Text	38
11.3 Special Characters	39
11.4 General Purpose Output	40
11.5 Display Functions	40
11.6 Data Security	41
11.7 Miscellaneous	41
11.8 Command By Number	41
12 Appendix	43
12.1 Specifications	43
12.1.1 Environmental	43
12.1.2 Electrical	43
12.1.3 Optical	43
12.2 Physical Layout	44
12.3 Ordering Information	46
12.4 Definitions	46
12.5 Contacting Matrix Orbital	47
12.6 Revision History	47

1 Getting Started

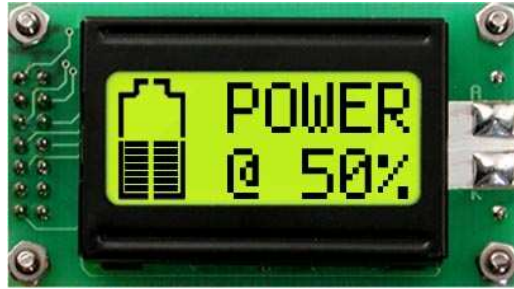

Figure 1: LCD0821

The LCD0821 is an intelligent LCD display designed to decrease development time by providing an instant solution to any project. With the ability to communicate via serial RS-232/TTL and I²C protocols, the versatile LCD0821 can be used with virtually any controller. The ease of use is further enhanced by an intuitive command structure to allow display settings such as backlight brightness, contrast and baud rate to be software controlled. Additionally, up to forty custom characters such as character sets for bar graphs, medium and large numbers may be stored in the non-volatile memory to be easily recalled and displayed at any time.

1.1 Display Options Available

The LCD0821 comes in a wide variety of colors including the standard yellow/green or inverse yellow, the popular blue/white and the crisp white/grey as well as inverse red which is excellent for viewing at night. Extended voltage, and temperature options are also available, to allow you to select the display which will best fit your project needs.

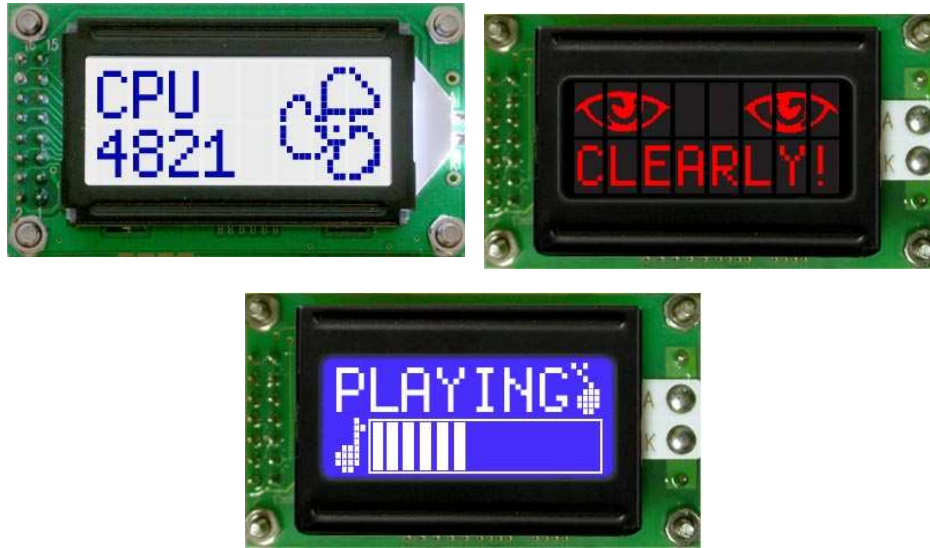

Figure 2: LCD0821 Options

1.2 Accessories

NOTE Matrix Orbital provides all the interface accessories needed to get your display up and running. You will find these accessories and others on our e-commerce website at <http://www.matrixorbital.com>. To contact a sales associate see Section 12.5 on page 47 for contact information.



Figure 3: 5V Power Cable Adapter



Figure 4: 12V Power Cable Adapter (V/VPT Models)



Figure 5: Breadboard Cable

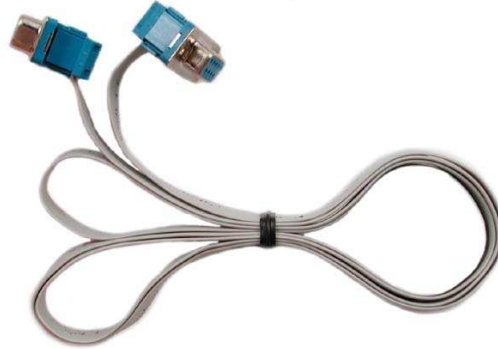

Figure 6: Serial Cable 4FT

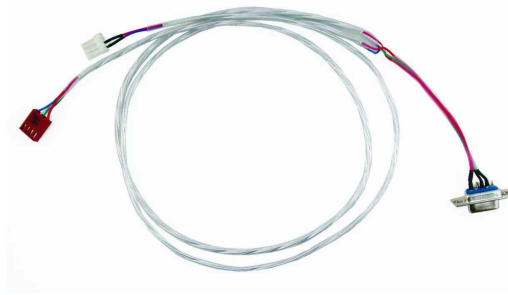

Figure 7: Communication and 5V Power Cable

1.3 Features

- 8 column by 2 line alphanumeric liquid crystal display
- Selectable communication protocol, serial at RS-232 or TTL levels or I²C
- One, 5V -20mA, general purpose output for a variety of applications
- Lightning fast communication speeds, up to 57.6 kbps for RS-232 and 100 kbps for I²C
- Extended temperature available for extreme environments of -20C to 70C
- Extended voltage power supply available
- Built in font with provision for up to 8 user defined characters
- Up to 127 modules addressable on the same 2 wire I²C interface
- Ability to add a customized splash / startup screen
- Software controlled contrast and brightness with configurable time-out setting up to 90 minutes
- Horizontal or vertical bar graphs

1.4 Connecting to a PC

The LCD0821 connects seamlessly to a PC and it is an excellent means of testing the functionality. To connect your display to a PC, you will require a standard RS-232 9-pin serial cable such as the one pictured in *figure 6 on the previous page*, as well as a modified 5V power adapter such as the one pictured in *figure 3 on page 2*.

In order to connect your display to a personal computer follow these easy instructions:

1. Plug the serial cable into the com port you wish to use.
2. Connect the modified 5V power adapter to a power lead from your PC power supply (you will have to open your computer case).
3. Connect the serial cable to the DB-9 connector on the back of the display.
4. Connect the 5V power adapter to the 4-pin connector on the back of the display.

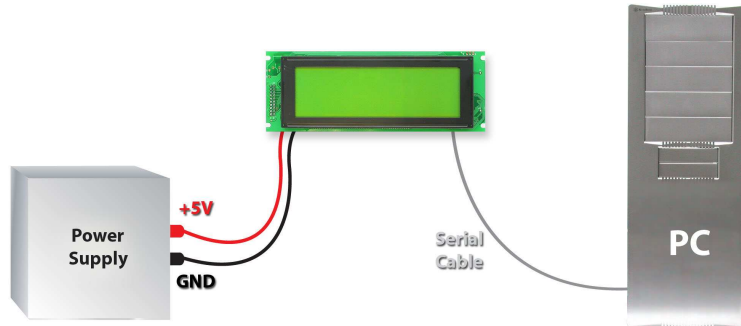

WARNING DO NOT use the standard floppy drive power connector, as this will not provide you with the correct voltage and will damage the display module.

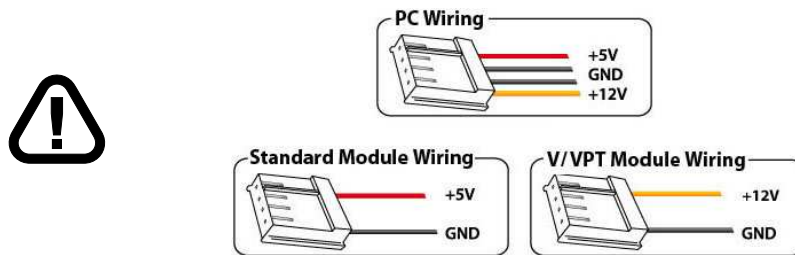

Figure 8: PC vs Matrix Orbital Display Module Wiring

1.5 Installing the Software

1.5.1 uProject

uProject was designed by Matrix Orbital to provide a simple and easy to use interface that will allow you to test all of the features of our alpha numeric displays.

To install uProject from the Matrix Orbital CD, follow the following steps:

1. Insert the Matrix Orbital CD-ROM into the CD drive
2. Locate the file, *uProject.exe*, which should be in the “CD-drive:\Download” directory.
3. Copy *uProject.exe* to a directory that you wish to run it from.
4. Double click on "uProject.exe"

Be sure to check the information selected in the COM Setup the first time uProject is run. Once this information is entered correctly the program can be used to control all functions of the graphic display.



Comport	The serial port the display is plugged in to.
Baudrate	The communication speed the display module is set to. (Default 19,200)

Figure 9: uProject Settings

NOTES

- uProject and other alphanumeric software may also be downloaded from Matrix Orbital's support site at http://www.matrixorbital.ca/software/software_alpha/
-

2 Hardware Information

Refer to the following diagram for this chapter:

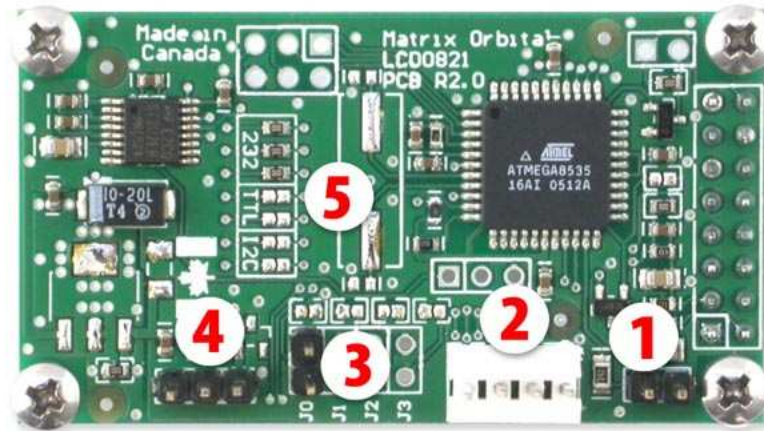

- 1 GPO
- 2 Power / Data Connector
- 3 Manual Override
- 4 RS-232 Header
- 5 Protocol Select Jumpers

Figure 10: LCD0821

2.1 Power/Data Connector

The *Power/Data Connector* provides a standard connector for powering the display module. The LCD0821 requires five volts for the standard display module and between nine and fifteen for the wide voltage (V) model. The voltage is applied through pins one and four of the four pin *Power/Data connector*. Pins two and three are reserved for serial transmission, using either the RS-232/TTL or the I²C protocol, depending on what has been selected by the *Protocol Select Jumpers*. Pins two and three may be reversed by changing the *Legacy Connector Jumpers* in order to be compatible with previous PCB revisions.

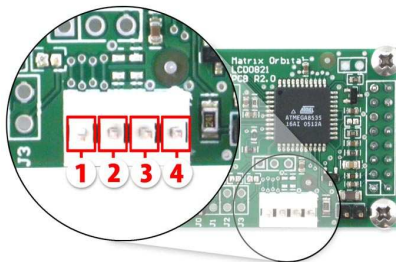

- Pin 1** PWR (See table 1 on the next page)
- Pin 2** Rx \ SCL (I²C clock)
- Pin 3** Tx \ SDA (I²C data)
- Pin 4** GND

Figure 11: Power Connector and Pin out

Table 1: Power Requirements

	Standard	-V
Supply Voltage	+5Vdc \pm 0.25V	+9V to +15V
Backlight On Supply	105 mA typical	
Backlight Off Supply	30 mA	



WARNINGS

- Do not apply any power with reversed polarization.
- Do not apply any voltage other than the specified voltage.

2.2 RS-232 Header

The *RS-232 Header* provides an alternate serial transmission connector.

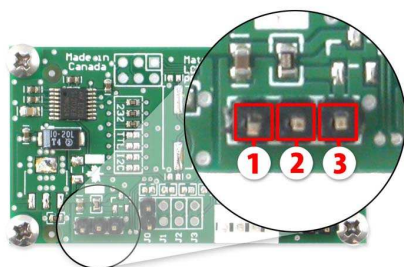

- Pin 1** GND
- Pin 2** Rx
- Pin 3** PWR (*See table 1*)

Figure 12: Power Connector and Pin out

NOTE This header is for RS-232 transmission only.

2.3 Manual Override

The *Manual Override* is provided to allow the LCD0821 to be reset to factory defaults. This can be particularly helpful if the display module has been set to an unknown baud rate or I²C Slave Address and you are no longer able to communicate with it. If you wish to return the module to its default settings you must:

1. Power off the display module.
2. Place a Jumper on the *Manual Override* pins.
3. Power up the display module.
4. The display module is now set to its default values listed below in *table 2*.
5. Edit and save settings.

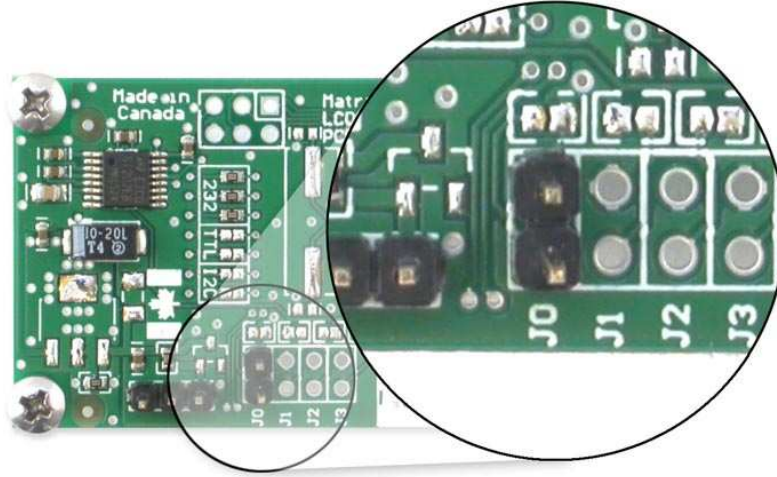

Figure 13: Manual Override Jumper

Table 2: Default Values

Brightness	255
Baud Rate	19.2 kbps
I²C Slave Address	0x50
Data Lock	False
RS232AutoTransmitData	True

NOTE The display module will revert back to the old settings once turned off, unless the settings are saved.

2.4 General Purpose Output

A unique feature of the LCD0821 is the ability to control relays and other external devices using a *General Purpose Output*, which can provide up to 20 mA of current and +5Vdc from the positive side of the GPO. This is limited by a 240 ohm resistor as pictured below in *figure 14*. If the device, which is being driven by a GPO, requires a relatively high current (such as a relay) and has an internal resistance of its own greater than 250 ohms, then the 240 ohm resistor may be removed and replaced with a Jumper.

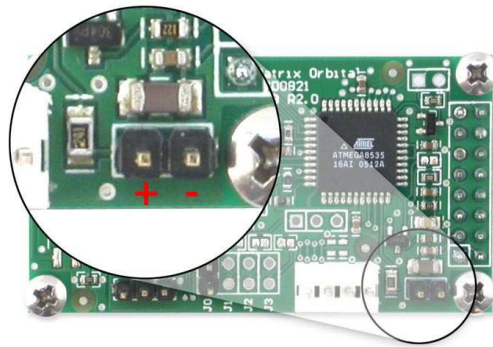

- GND
- + MAX: 20 mA, +5Vdc

Figure 14: General Purpose Output



WARNING If connecting a relay, be sure that it is fully clamped using a diode and capacitor in order to absorb any electro-motive force (EMF) which will be generated.

2.5 Protocol Select Jumpers

The *Protocol Select Jumpers*, pictured below in *figure 15*, provide the means necessary to toggle the display module between RS-232, TTL, and I²C protocols. As a default, the jumpers are set to RS-232 mode with solder jumps on the 232 jumpers. In order to place the display module in I²C mode you must first remove the solder jumps from the 232 jumpers and then place them on the I2C jumpers. The display will now be in I²C mode and have a default slave address of 0x50 unless it has been changed. Similarly, in order to change the display to TTL mode, simply remove the zero ohm resistors from the 232 or I²C jumpers and solder them to the TTL jumpers.

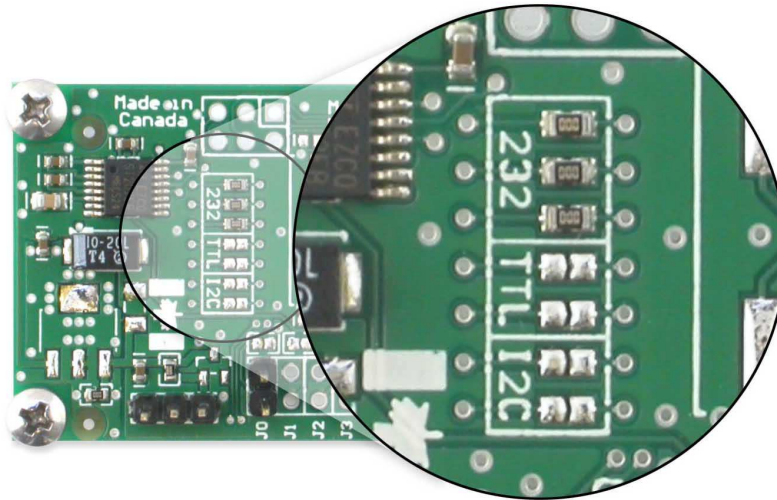

Figure 15: Protocol Select Jumpers

3 Troubleshooting

3.1 The display does not turn on when power is applied.

- First, you will want to make sure that you are using the correct power connector. Standard floppy drive power cables from your PC power supply may fit on the Power/Data Connector however they do not have the correct pin out as can be seen in *figure 8 on page 4*. Matrix Orbital supplies power cable adapters for connecting to a PC, which can be found in the *Accessories Section on page 2*.
- The next step is to check the power cable which you are using for continuity. If you don't have an ohm meter, try using a different power cable, if this does not help try using a different power supply.
- The last step will be to check the *Power / Data Connector* on the LCD0821. If the *Power / Data Connector* has become loose, or you are unable to resolve the issue, please contact Matrix Orbital, see *12.5 on page 47* for contact information.

3.2 The display module is not communicating.

- First, check the communication cable for continuity. If you don't have an ohm meter, try using a different communication cable. If you are using a PC try using a different Com Port.
- Second, please ensure that the display module is set to communicate on the protocol that you are using, by checking the *Protocol Select Jumpers*. To change the protocol used by the display module see *Section 2.5 on the preceding page*.
- Third, ensure that the host system and display module are both communicating on the same baud rate. The default baud rate for the display module is 19200 bps.

- If you are communicating to the display via I²C please ensure that the data is being sent to the correct address. The default slave address for the display module is 0x50.

NOTE I²C communication will always require pull up resistors.

- Finally, you may reset the display to it's default settings using the *Manual Override Jumper*, see *Section 2.3 on page 7*.

3.3 The display module is communicating, however text cannot be displayed.

- A common cause may be that the contrast settings have been set to low. The solution to this problem is to adjust the contrast settings. The default setting that will work in most environments is 128.

NOTE Optimal contrast settings may vary according to factors such as temperature, viewing angle and lighting conditions.

If you are unable to resolve any issue please contact Matrix Orbital. See *12.5 on page 47* for contact information.

4 Communications

4.1 Introduction

The commands listed in this chapter describe how to configure data flow on the LCD0821.

4.1.1 I²C Communication Summary

The LCD0821 is capable of communicating at 100 KHz in I²C mode, with 127 units addressable on a single I²C communication line. However, in order to communicate via I²C you must first ensure that pull up resistors, with a nominal value of 1K to 10K, are placed on the SCL and SDA communication lines coming from pins two and three of the Data / Power Connector respectively. Data responses by the module are automatically output via RS232, in case the host will be querying the module, it is necessary for the host to inform the module that its responses are to be output via I²C. This can be done by sending command 254 / 160 / 0 to turn off auto transmission of data in RS232. This will keep the data in the buffer until the master clocks a read of the slave. The I²C data lines operate at 5V normally or 3.3V for -1U style units. The LCD0821 uses 8-bit addressing, with the 8th or Least Significant Bit (LSB) bit designated as the read/write bit, a 0 designates a write address and a 1 designates a read address. The default read address of the display module will be 0x51, whereas the write address is 0x50 by default. This address may be changed by using cmd 254 / 51 / <address>. The LCD0821 should only be sent addresses that are even (LSB is 0). When the I²C master wishes to write to the display, the effective address is \$50 (0101 0000) , since the LSB has to be

0 for an I²C master write. When the I²C master wishes to read the LCD0821, the effective address is \$51 (0101 0001), since the LSB has to be 1 for an I²C master read.

If we take a standard Phillips 7 bit address of \$45 (100 0101), Matrix Orbital's LCD0821 would describe this Phillips I²C address as \$8A (1000 1010). The read address would be \$8B (1000 1011).

The unit does not respond to general call address (\$00).

When communicating in I²C the LCD0821 will send an ACK on the 9th clock cycle when addressed. When writing to the display module, the display will respond with a ACK when the write has successfully been completed. However if the buffer has been filled, or the module is too busy processing data it will respond with a NAK. When performing a multiple byte read within one I²C transaction, each byte read from the slave should be followed by an ACK to indicate that the master still needs data, and a NAK to indicate that the transmission is over.

The LCD0821 has some speed limitations, especially when run in I²C mode. Here are some considerations when writing I²C code:

- * to be able to read the replies of query commands (eg. cmds 54, 55) the following command must be sent (only needs to be sent once, so this can be done somewhere in init): 254 / 160 / 0 this command puts the reply data in the I²C output buffer instead of the RS232 output buffer. Please note that due to a 16 byte output buffer, query commands that reply with more than 16 bytes cannot be read (eg cmd Get FileSystem Directory)

- * 3ms delay between the read commands

- * 625us delay in between data bytes within a transaction is necessary

- * 375us between transactions is necessary

NOTE These delays are conservative, and may be decreased based on performance

4.1.2 I²C Transaction Example

The typical I²C transaction contains four parts: the start sequence, addressing, information, and stop sequence. To begin a transaction the data line, SDA, must toggle from high to low while the clock line, SCL, is high. Next, the display must be addressed using a one byte hexadecimal value, the default to write to the unit is 0x50, while read is 0x51. Then information can be sent to the unit; even when reading, a command must first be sent to let the unit know what type of information it is required to return. After each bit is sent, the display will issue an ACK or NACK as described above. Finally, when communication is complete, the transaction is ended by toggling the data line from low to high while the clock line is high. An example of the use of this algorithm to write a simple "HELLO" message can be seen in 3.

Table 3: I²C Transaction Algorithm

START	Toggle SDA high to low
Address	0x50
Information	0x48 0x45 0x4C 0x4C 0x4F
STOP	Toggle SDA low to high

4.1.3 Serial Communication

In addition to being able to communicate via I²C the LCD0821 communicates natively through the RS-232 protocol at a default baud rate of 19,200 bps and is capable of standard baud rates from 9600 to 115,200 bps. Furthermore the LCD0821 is also capable of reproducing any non-standard baud rate in between using values entered into our baud rate generation algorithm and set through command 164 (0xA4). The display module communicates at standard voltage levels of -30V to +30V or at TTL levels of 0 to +5V by setting the *Protocol Select Jumpers* to TTL.

4.2 Changing the I²C Slave Address

Syntax	Hexadecimal	0xFE 0x33 [adr]	
	Decimal	254 51 [adr]	
	ASCII	254 “3” [adr]	
Parameters	Parameter	Length	Description
	adr	1	The new I ² C write address (0x00 - 0xFF).
Description	This command sets the I ² C write address of the module between 0x00 and 0xFF. The I ² C write address must be an even number and the read address is automatically set to one higher. For example if the I ² C write address is set to 0x50, then the read address is 0x51.		
<hr/>			
NOTE The change in address is immediate.			
<hr/>			
Remembered	Always		
Default	0x50		

4.3 Changing the Baud Rate

Syntax	Hexadecimal	0xFE 0x39 [speed]	
	Decimal	254 57 [speed]	
	ASCII	254 “9” [speed]	
Parameters	Parameter	Length	Description
	speed	1	Hex value corresponding to a baud rate.

Description This command sets the RS-232 port to the specified [speed]. The change takes place immediately. [speed] is a single byte specifying the desired port speed. Valid speeds are shown in the table below. The display module can be manually reset to 19,200 baud in the event of an error during transmission, including transmitting a value not listed below, by setting the manual override jumper during power up. However, it should be noted that this command will be ignored until the manual override jumper is removed again.

Hex Value	Baud Rate
53	1200
29	2400
CF	4800
67	9600
33	19200
22	28800
19	38400
10	57600
8	115200

NOTE This command is not available in I²C mode.

Remembered Always
 Default 19,200 bps

4.4 Setting a Non-Standard Baud Rate

Syntax Hexadecimal 0xFE 0xA4 [speed]
 Decimal 254 164 [speed]

Parameter	Length	Description
speed	2	Inputed LSB MSB from baud rate formula (12-2047).

Description This command sets the RS-232 port to a non-standard baud rate. The command accepts a two byte parameter that goes directly into the modules baud generator. Use the formula, $speed = \frac{CrystalSpeed}{8 \times DesiredBaud} - 1$ to calculate the [speed] for any baud rate setting. The speed can be anywhere from 12 to 2047 which corresponds to a baud range of 977 to 153,800 baud. Setting the baud rate out of this range could cause the display to stop working properly and require the Manual Override jumper to be set.

Remembered Always

Examples

Crystal Speed 16 Mhz

Desired BAUD 13,500

$$speed = \frac{crystalspeed}{8 * DesiredBaud} - 1 \quad speed = \frac{16,000,000}{8 * 13,500} - 1$$

$$speed = 148.15 - 1$$

$$speed = 147.15$$

- **LSB** = 0x93 (rounded)
- **MSB** = 0x00
- Intended Baud Rate: 13,500 baud Actual Baud Rate:
 $\frac{16,000,000}{8(147+1)} = 13,514$ Percent Difference: 0.1%

NOTES

- Results from the formula are rounded down to the nearest whole number (i.e 73.07 = 73).
- This formula becomes less accurate as baud rates increase, due to rounding.
- Place the speed result backwards into the formula to receive the actual baud rate.
($Baud = \frac{CrystalSpeed}{8(speed+1)}$)
- The actual baud rate must be within 3% of the intended baud rate for the device to communicate.

NOTES

- This command is not available in I²C mode.
-

5 Text

5.1 Introduction

The LCD0821 is an intelligent display module, designed to reduce the amount of code necessary to begin displaying data. This means that it is able to display all ASCII formatted characters and strings that are sent to it, which are defined in the current character set. The display module will begin displaying text at the top left corner of the display area, known as home, and continue to print to the display as if it was a page on a typewriter. When the text reaches the bottom right row, it is able to automatically scroll all of the lines up and continue to display text, with the auto scroll option set to on.

5.1.1 Character Set

		Higher 4-bit (D4 to D7) of Character Code (Hexadecimal)																
		0	1	2	3	4	5	6	7	8	9	A	B	C	D	E	F	
Lower 4-bit (D0 to D3) of Character Code (Hexadecimal)	0	CG RAM (1)	⌂		0	E	P	'	P	G	é	á		0	R	P	T	
	1	CG RAM (2)	⌂	'	1	A	0	a	q	u	a	é	í		U	t	y	o
	2	CG RAM (3)	⌂	"	2	R	b	r	e	á	é	ó		°	ó	é	ó	ó
	3	CG RAM (4)	⌂	#	3	O	S	c	s	á	ó	ó		'	P	l	e	q
	4	CG RAM (5)	⌂	\$	4	D	T	d	t	á	ó	ó		'	e	r	z	o
	5	CG RAM (6)	⌂	%	5	E	u	e	u	á	ó	ó		'	e	r	z	o
	6	CG RAM (7)	⌂	&	6	F	V	v	á	ó	ó							
	7	CG RAM (8)	⌂	'	7	G	w	w	á	ó	ó							
	8	CG RAM (1)	⌂	(8	X	x	á	ó	ó								
	9	CG RAM (2)	⌂)	9	I	y	i	á	ó	ó							
	A	CG RAM (3)	⌂	*	A	Z	z	á	ó	ó								
	B	CG RAM (4)	⌂	+	B	K	k	á	ó	ó								
	C	CG RAM (5)	⌂	,	C	L	l	á	ó	ó								
	D	CG RAM (6)	⌂	-	D	M	m	á	ó	ó								
	E	CG RAM (7)	⌂	.	E	N	n	á	ó	ó								
	F	CG RAM (8)	⌂	/	F	O	o	á	ó	ó								

Figure 16: European Character Set

		Higher 4-bit (D4 to D7) of Character Code (Hexadecimal)																		
		0	1	2	3	4	5	6	7	8	9	A	B	C	D	E	F			
Lower 4-bit (D0 to D3) of Character Code (Hexadecimal)	0	CG RAM (1)			0	1	2	3	4	5	6	7	8	9	A	B	C	D	E	F
	1	CG RAM (2)			1	2	3	4	5	6	7	8	9	A	B	C	D	E	F	
	2	CG RAM (3)			2	3	4	5	6	7	8	9	A	B	C	D	E	F		
	3	CG RAM (4)			3	4	5	6	7	8	9	A	B	C	D	E	F			
	4	CG RAM (5)			4	5	6	7	8	9	A	B	C	D	E	F				
	5	CG RAM (6)			5	6	7	8	9	A	B	C	D	E	F					
	6	CG RAM (7)			6	7	8	9	A	B	C	D	E	F						
	7	CG RAM (8)			7	8	9	A	B	C	D	E	F							
	8	CG RAM (1)			8	9	A	B	C	D	E	F								
	9	CG RAM (2)			9	A	B	C	D	E	F									
	A	CG RAM (3)			A	B	C	D	E	F										
	B	CG RAM (4)			B	C	D	E	F											
	C	CG RAM (5)			C	D	E	F												
	D	CG RAM (6)			D	E	F													
	E	CG RAM (7)			E	F														
	F	CG RAM (8)			F															

Figure 17: Japanese Character Set

NOTE The default font set for these units is Japanese, save for the -WB color option. Please consult the PCN pages at www.matrixorbital.ca or a sales representative to confirm font set availability.

5.1.2 Control Characters

In addition to a full text set, the LCD0821 display supports the following ASCII Control characters:

0x08 Backspace

0x0C Clear screen / New page

0x0D Carriage return

0x0A Line feed / New line

5.2 Auto Scroll On

Syntax	Hexadecimal	0xFE 0x51
	Decimal	254 81
	ASCII	254 “Q”
Description	When auto scrolling is on, it causes the display to shift the entire display’s contents up to make room for a new line of text when the text reaches the end of the last row.	
Remembered	Yes	
Default	On	

5.3 Auto Scroll Off

Syntax	Hexadecimal	0xFE 0x52
	Decimal	254 82
	ASCII	254 “R”
Description	When auto scrolling is disabled the text will wrap to the top left corner of the display area when the text reaches the end of last row.	
Remembered	Yes	

5.4 Clear Screen

Syntax	Hexadecimal	0xFE 0x58
	Decimal	254 88
	ASCII	254 “X”
Description	This command will immediately clear all of the contents of the display.	
Remembered	No	

5.5 Changing the Startup Screen

Syntax	Hexadecimal	0xFE 0x40
	Decimal	254 64
	ASCII	254 “@”
Description	In order to change the text that is displayed by the LCD0821 when it starts up simply send the command bytes 254 64 followed by the characters that you wish to display, starting from the top left. This command will automatically line wrap the characters that are sent to it.	

Remembered Yes

5.6 Set Auto Line Wrap On

Syntax	Hexadecimal	0xFE 0x43
	Decimal	254 67
	ASCII	254 "C"
Description	Enabling Auto Line Wrap will allow the cursor to automatically wrap over to the next line when the current line is full.	

NOTE Line wraps may occur in the middle of a word.

Remembered Yes

5.7 Set Auto Line Wrap Off

Syntax	Hexadecimal	0xFE 0x44
	Decimal	254 68
	ASCII	254 "D"
Description	Disabling Auto Line Wrap will allow you to change the line configuration. The normally sequential progression becomes an alternating pattern. Rather than moving from line 1 to 2 to 3, the display will write from line 1 to 3 to 2. For a two line display, this means that a row's worth of characters written between the first and second lines or after the second will not be displayed on the screen or wrapped. The four line models will see only an alteration in line flow.	

Remembered Yes

5.8 Set Cursor Position

Syntax	Hexadecimal	0xFE 0x47 [col] [row]	
	Decimal	254 71 [col] [row]	
	ASCII	254 "G" [col] [row]	
Parameters	Parameter	Length	Description
	col	1	Column
	row	1	Row

Description This command will allow you to manually set the cursor position, which controls the text insertion point, by specifying the [col] and [row] of the new proposed cursor position.

NOTE If the cursor position is set past the end of a line it will wrap to the beginning of the next line.

Remembered No

5.9 Go Home

Syntax Hexadecimal 0xFE 0x48
Decimal 254 72
ASCII 254 "H"

Description This command will return the cursor to the top left corner of the display area, identified as row one, column one.

Remembered No

5.10 Move Cursor Back

Syntax Hexadecimal 0xFE 0x4C
Decimal 254 76
ASCII 254 "L"

Description This command will move the cursor back one space. If this command is sent when the cursor is at the home position the cursor will wrap to the last row / column position if line wrap is on. Sending this command will not effect the text displayed on the module, however any characters that are sent will over write the current characters that are being displayed.

Remembered No

5.11 Move Cursor Forward

Syntax Hexadecimal 0xFE 0x4D
Decimal 254 77
ASCII 254 "M"

Description	This command will move the cursor forward one space. If this command is sent when the cursor is at the bottom right position the cursor will wrap back to the home position if line wrap is on. Sending this command will not effect the text displayed on the module, however any characters that are sent will over write the current characters that are being displayed.
Remembered	No

5.12 Underline Cursor On

Syntax	Hexadecimal 0xFE 0x4A Decimal 254 74 ASCII 254 “J”
Description	This command will cause the LCD0821 to display an underline cursor at the current text insertion point.
Remembered	Yes

5.13 Underline Cursor Off

Syntax	Hexadecimal 0xFE 0x4B Decimal 254 75 ASCII 254 “K”
Description	This command will turn the the underline cursor off.
Remembered	Yes

5.14 Blinking Block Cursor On

Syntax	Hexadecimal 0xFE 0x53 Decimal 254 83 ASCII 254 “S”
Description	This command will cause the LCD0821 to display a block cursor at the current text insertion point.
Remembered	Yes

5.15 Blinking Block Cursor Off

Syntax	Hexadecimal	0xFE 0x54
	Decimal	254 84
	ASCII	254 “T”
Description	This command will turn the block cursor off.	
Remembered	Yes	

6 Special Characters

6.1 Introduction

The LCD0821 has the ability to create four different sets of eight custom characters and save them to internal banks of memory. Each set of eight can be recalled from memory at any time, and selected characters can be written to the display screen. Characters and sets can be created at any time, saved for later use, and displayed to the screen through the intuitive command structure described below.

6.2 Creating a Custom Character

Syntax	Hexadecimal	0xFE 0x4E [refID] [data]	
	Decimal	254 78 [refID] [data]	
	ASCII	254 “N” [refID] [data]	
Parameters	Parameter	Length	Description
	refID	1	Character reference ID (0-7).
	data	8	Character data.

Description The LCD0821 allows for up to eight custom defined characters to be added onto the the character set. A custom character is a five by eight pixel matrix with each row represented by a byte value. For example:

Custom Character 'h'					Decimal	Hex
1	0	0	0	0	16	0x10
1	0	0	0	0	16	0x10
1	0	0	0	0	16	0x10
1	0	0	0	0	16	0x10
1	0	1	1	0	22	0x16
1	1	0	0	1	25	0x19
1	0	0	0	1	17	0x11
1	0	0	0	1	17	0x11

Each bit value of one, in the table, represents an on pixel, whereas a value of zero represents a pixel that is turned off. Therefore in order to define custom character 'h' you would send the command byte prefix 254 followed by the command 78. Next, you will have to select the memory location in which you wish to save the character in. The available memory locations for this command are zero through to seven. After sending the memory location, or [refID], you may then send the eight byte custom character data in sequence from the top to the bottom.

Once you have defined a custom character you may display it by sending the display module the [refID]. For example if a custom character was saved in position one, the command to display the custom character, at the current cursor position, would be simply to send the number one to the display module without quotes.

Remembered No

6.3 Saving Custom Characters

Syntax	Hexadecimal	0xFE 0xC1 [Bank] [ID] [Data]	
	Decimal	254 193 [Bank] [ID] [Data]	
Parameters	Parameter	Length	Description
	Bank	1	Memory bank to save to (0-4).
	ID	1	Character ID (0-7)
	Data	8	Character Definition

Description New to the LCD0821 has added five non-volatile memory banks for custom character storage. This is intended to allow you to create your own custom bar graphs, medium/large numbers and startup screen. However, each memory bank may be used to store a set of any eight custom characters; with the only provision being that memory bank zero contains the characters that will be used in the startup screen. By default the memory banks will be loaded as follows:

[Bank]	Description
0	Startup screen characters.
1	Horizontal bars
2	Vertical bars
3	Medium numbers

In order to save new custom characters into a memory bank, follow the same process as you would for creating a custom character, see Section 6.2 on page 22, only use 254 193 [Bank Number] before sending the [ID] and character [Data].

Remembered Yes

6.4 Loading Custom Characters

Syntax Hexadecimal 0xFE 0xC0 [Bank]
 Decimal 254 192 [Bank]

Parameter	Length	Description
Bank	1	Memory bank to save to (0-4).

Description This command is used to load the custom characters into the volatile memory so that they may be used. If custom bar graph or number characters are stored in the memory banks, this command may be used instead of initializing the bar graph / number. To use this command send the command bytes followed by the [Bank] that contains the custom character data that you want to retrieve.

Remembered No

6.5 Save Startup Screen Custom Characters

Syntax Hexadecimal 0xFE 0xC2 [refID] [data]
 Decimal 254 194 [refID] [data]

Parameter	Length	Description
refID	1	Character reference ID (0-7).
data	8	Character data.

Description Using this command you may create the custom characters. that will be stored in memory bank zero, which will be used in the startup screen. For more information about creating custom characters see **Section 6.2 on page 22**.

NOTES

- Changes only take place once the power has been cycled.
- This command is the same as sending CMD 254 / 193 / 0 / [ID] / [DATA]

Remembered Yes

6.6 Initialize Medium Number

Syntax Hexadecimal 0xFE 0x6D
Decimal 254 109
ASCII 254 "m"

Description This command will load the default medium number characters into the volatile memory. If you have stored your own custom medium numbers, use the 'Load Custom Characters' command to load your custom character data into the volatile memory. This command will allow you to use the 'Place Medium Numbers' command.

Remembered No

6.7 Place Medium Numbers

Syntax Hexadecimal 0xFE 0x6F [Row] [Col] [Digit]
Decimal 254 111 [Row] [Col] [Digit]
ASCII 254 "o" [Row] [Col] [Digit]

Parameter	Length	Description
Row	1	The row number.
Col	1	The column number.
Digit	1	Medium number to place (0-9).

Description This command will place a medium number (two columns high) at the [row] and [col] specified.

NOTE Medium Numbers must be initialized before this command is executed.

Remembered No

6.8 Initialize Horizontal Bar

Syntax	Hexadecimal	0xFE 0x68
	Decimal	254 104
	ASCII	254 "h"
Description	This command will load the default horizontal bar characters into the volatile memory. If you have stored your own custom horizontal bar data, use the 'Load Custom Characters' command instead to load your custom bar data into the volatile memory. This command will allow you to use the 'Place Horizontal Bar' command.	
Remembered	No	

6.9 Place Horizontal Bar Graph

Syntax	Hexadecimal	0xFE 0x7C [Col] [Row] [Dir] [Length]	
	Decimal	254 124 [Col] [Row] [Dir] [Length]	
	ASCII	254 "[" [Col] [Row] [Dir] [Length]	
Parameters	Parameter	Length	Description
	Col	1	The column number.
	Row	1	The row number.
	Dir	1	The direction of the bar data (0 or 1).
	Length	1	The length of the bar data.
Description	This command will place a bar graph at [row], [column]. A [Dir] value of zero will cause the bar to go right, and one will cause the bar to go left. The [Length] is the size in pixels of the bar graph.		

NOTES

- Horizontal Bars must be initialized before this command is executed.
- Bar graphs may be one directional only.

Remembered No

6.10 Initialize Narrow Vertical Bar

Syntax	Hexadecimal	0xFE 0x73
	Decimal	254 115
	ASCII	254 "s"

Description This command will load the narrow vertical bar characters into the volatile memory. If you have stored your own custom vertical bar data, use the 'Load Custom Characters' command instead to load your custom bar data into the volatile memory. This command will allow you to use the 'Place Vertical Bar' command.

NOTE Narrow bars have a width of two pixels.

Remembered No

6.11 Initialize Wide Vertical Bar

Syntax Hexadecimal 0xFE 0x76
Decimal 254 118
ASCII 254 "v"

Description This command will load the wide vertical bar characters into the volatile memory. If you have stored your own custom vertical bar data, use the 'Load Custom Characters' command instead to load your custom bar data into the volatile memory. This command will allow you to use the 'Place Vertical Bar' command.

NOTE Wide bars have a width of five pixels.

Remembered No

6.12 Place Vertical Bar

Syntax Hexadecimal 0xFE 0x3D [Column] [Length]
Decimal 254 61 [Column] [Length]
ASCII 254 "= " [Column] [Length]

Parameter	Length	Description
Column	1	The column number.
Length	1	The length of the bar data.

Description This command will place a bar graph at the specified [Column] with the specified [Length]. The [Length] is the size in pixels of the bar graph.

NOTES

- A Vertical Bar style must be initialized before this command is executed.
- Bar graphs may be one directional only.

Remembered No

7 General Purpose Output

7.1 Introduction

General purpose outputs allow you to connect devices, such as LEDs, to the LCD0821 and supply them with up to 20mA of current at 5V. The LCD0821 has 3 GPOs which are software controlled, with functions to turn them on/off and set the power state for the next startup.

7.2 General Purpose Output Off

Syntax	Hexadecimal	0xFE 0x56 [Num]	
	Decimal	254 86 [Num]	
	ASCII	254 "V" [Num]	
Parameters	Parameter	Length	Description
	Num	1	GPO number.
Description	This command turns OFF general purpose output [num].		

NOTE OFF means that the output is pulled HIGH.

Remembered Yes

7.3 General Purpose Output On

Syntax	Hexadecimal	0xFE 0x57 [Num]	
	Decimal	254 87 [Num]	
	ASCII	254 "W" [Num]	
Parameters	Parameter	Length	Description
	Num	1	GPO number.

Description This command turns ON general purpose output [num]. The standard GPO's on the LCD0821 output 20mA of current at 5V.

NOTE ON means the output is pulled LOW.

Remembered Yes

7.4 Set Startup GPO state

Syntax Hexadecimal 0xFE 0xC3 [Num] [state]
Decimal 254 195 [Num] [state]

Parameter	Length	Description
Num	1	GPO number.
state	1	Startup state (0: Off, 1: On)

Description This command will set the startup state for the GPO on the next power up. A value of one will cause the GPO to be off on the next startup while a value of one will cause the GPO to be on.

NOTE This command does not affect the current state of the GPO.

Remembered Always

8 Display Functions

8.1 Introduction

The LCD0821 employs software controlled display settings, which allow for control over, clearing the screen, changing the brightness and contrast or setting timers for turning it on or off. The combination of these allow you complete software control over your display's appearance.

8.2 Display On

Syntax Hexadecimal 0xFE 0x42 [min]
Decimal 254 66 [min]
ASCII 254 "B" [min]

Parameter	Length	Description
min	1	Minutes before turning the display on (0 to 90).

Description	This command turns the backlight on after the [minutes] timer has expired, with a ninety minute maximum timer. A time of 0 specifies that the backlight should turn on immediately and stay on. When this command is sent while the remember function is on, the timer will reset and begin after power up.
Remembered	Yes
Default	0

8.3 Display Off

Syntax	Hexadecimal 0xFE 0x46 Decimal 254 70 ASCII 254 "F"
Description	This command turns the backlight off immediately. The backlight will remain off until a 'Display On' command has been received.
Remembered	Yes

8.4 Set Brightness

Syntax	Hexadecimal 0xFE 0x99 [brightness] Decimal 254 153 [brightness]						
Parameters	<table border="1"> <thead> <tr> <th>Parameter</th> <th>Length</th> <th>Description</th> </tr> </thead> <tbody> <tr> <td>brightness</td> <td>1</td> <td>Display brightness setting (0 to 255).</td> </tr> </tbody> </table>	Parameter	Length	Description	brightness	1	Display brightness setting (0 to 255).
Parameter	Length	Description					
brightness	1	Display brightness setting (0 to 255).					
Description	This command sets the display [brightness]. If the remember function is on, this command acts the same as 'Set and Save Brightness'.						
Remembered	Yes						
Default	255						

8.5 Set and Save Brightness

Syntax	Hexadecimal 0xFE 0x98 [brightness] Decimal 254 152 [brightness]						
Parameters	<table border="1"> <thead> <tr> <th>Parameter</th> <th>Length</th> <th>Description</th> </tr> </thead> <tbody> <tr> <td>brightness</td> <td>1</td> <td>Backlight setting (0 to 255).</td> </tr> </tbody> </table>	Parameter	Length	Description	brightness	1	Backlight setting (0 to 255).
Parameter	Length	Description					
brightness	1	Backlight setting (0 to 255).					
Description	This command sets and saves the display [brightness] as default.						
Remembered	Always						

8.6 Set Contrast

Syntax	Hexadecimal	0xFE 0x50 [contrast]					
	Decimal	254 80 [contrast]					
	ASCII	254 "P" [contrast]					
Parameters	<table border="1"><thead><tr><th>Parameter</th><th>Length</th><th>Description</th></tr></thead><tbody><tr><td>contrast</td><td>1</td><td>Contrast value (0 to 255).</td></tr></tbody></table>	Parameter	Length	Description	contrast	1	Contrast value (0 to 255).
Parameter	Length	Description					
contrast	1	Contrast value (0 to 255).					
Description	<p>This command sets the display's contrast to [contrast], where [contrast] is a value between 0x00 and 0xFF (between 0 to 255). Lower values cause 'on' elements in the display area to appear lighter, while higher values cause 'on' elements to appear darker. Lighting and temperature conditions will affect the actual value used for optimal viewing. Individual display modules will also differ slightly from each other in appearance. In addition, values for optimal viewing while the display backlight is on may differ from values used when backlight is off. This command does not save the [contrast] value, and is lost after power down; but this command has the option of remembering the settings when issued with the Remember function 'on'. When this is the case, this command is the same as the Set and Save Contrast command.</p>						

NOTE This command has only 32 levels for X-Board based displays, meaning eight contrast settings will have the same single effect. Effectively, values 0 through 7, 8 through 15, and so on will result in the same setting.

Remembered	Yes
Default	128

8.7 Set and Save Contrast

Syntax	Hexadecimal	0xFE 0x91 [contrast]					
	Decimal	254 145 [contrast]					
Parameters	<table border="1"><thead><tr><th>Parameter</th><th>Length</th><th>Description</th></tr></thead><tbody><tr><td>contrast</td><td>1</td><td>Contrast value (0 to 255).</td></tr></tbody></table>	Parameter	Length	Description	contrast	1	Contrast value (0 to 255).
Parameter	Length	Description					
contrast	1	Contrast value (0 to 255).					

Description This command sets the display's contrast to [contrast], where [contrast] is a value between 0x00 and 0xFF (between 0 to 255). Lower values cause 'on' elements in the display area to appear lighter, while higher values cause 'on' elements to appear darker. Lighting conditions will affect the actual value used for optimal viewing. Individual display modules will also differ slightly from each other in appearance. In addition, values for optimal viewing while the display backlight is on may differ from values used when backlight is off.

NOTE This command saves the [contrast] value so that it is not lost after power down.

Remembered Yes
 Default 128

9 Data Security

9.1 Introduction

Ensuring that your LCD0821 display's exactly what you want it to can be the difference between a projects success and failure. This is why we incorporate features such as Data Lock into the LCD0821 With this new feature you now are in control over of how and when settings will be changed so there is no need to worry about the module acting exactly like you expected it to because all the settings may be locked and remembered for the next power up.

9.2 Set Remember

Syntax	Hexadecimal	0xFE 0x93 [switch]	
	Decimal	254 147 [switch]	
Parameters	Parameter	Length	Description
	switch	1	0: Do not remember, 1: Remember

Description This command allows you to switch the remember function on and off. To use the remember function, set remember to on, then set all of the settings that you wish to save, settings that are listed as 'Remember: Yes' support being saved into the non-volatile memory. After you have set all of the commands that you wish to save, you may then cycle the power and check the display settings to ensure that all the settings have been saved. If you wish to use remember again after cycling the power, you must set it to on again.

NOTES

- Writing to non-volatile memory is time consuming and slows down the operation of the display.
 - Non-volatile memory has a 'write limit' and may only be changed approximately 100,000 times.
-

Remembered No
 Default Do not remember

9.3 Data Lock

Syntax	Hexadecimal	0xFE 0xCA 0xF5 0xA0 [level]	
	Decimal	254 202 245 160 [level]	
Parameters	Parameter	Length	Description
	level	1	Sets the data lock level

Description

Paranoia allows you to lock the module from displaying information, as well as enables the protection of the filesystem and module settings.

Each bit corresponds corresponds to a different lock level, while sending a zero will unlock your display as the following tables explains:

Bit	Data Lock Level	Description
0-2	Reserved	Should be left 0
3	Communication Speed Lock	When this bit is set (1) the Baud Rate and I ² C Slave address are locked
4	Setting Lock	When this bit is set (1) the display settings such as backlight, contrast and GPO settings are locked. (Internal EEPROM)
5	Reserved	Should be left 0
6	Command Lock	When this bit is set (1) all commands but commands 202/203 are locked. (cmd lock)
7	Display Lock	When this bit is set (1) the module is locked from displaying any new information. (text lock)

NOTES

- Sending a new data lock level will override the previous data lock level.
 - Data lock levels may be combined.
-

Remembered Always
Default 0
Examples

Hex	Dec	Binary	Description
0x00	0	0	Unlock
0x50	80	01010000	Setting and Command Lock

9.4 Set and Save Data Lock

Syntax Hexadecimal 0xFE 0xCB 0xF5 0xA0 [level]
 Decimal 254 203 245 160 [level]

Parameters	Parameter	Length	Description
	level	1	Sets the data lock level
Description	This command will set and save the data lock level. See the Data Lock section for more information.		
Remembered	Always		
Default	0		

9.5 Write Customer Data

Syntax	Hexadecimal	0xFE 0x34 [data]	
	Decimal	254 52 [data]	
	ASCII	254 "4" [data]	
Parameters	Parameter	Length	Description
	data	16	Writes the customer data
Description	Writes the customer Data. 16 Bytes of data can be saved in non-volatile memory.		
Remembered	No		

9.6 Read Customer Data

Syntax	Hexadecimal	0xFE 0x35	
	Decimal	254 53	
	ASCII	254 "5"	
Description	Reads whatever was written by Write Customer Data.		
Remembered	No		

10 Miscellaneous

10.1 Introduction

This chapter covers the 'Report Version Number' and 'Read Module Type' commands. These commands can be particularly useful to find out more information about the display module before contacting technical support.

10.2 Read Version Number

Syntax Hexadecimal 0xFE 0x36
 Decimal 254 54
 ASCII 254 "6"

Description This command will return a byte representing the version of the module, see the following table as an example:

Hex Value	Version Number
0x19	Version 1.9
0x57	Version 5.7

Remembered No

10.3 Read Module Type

Syntax Hexadecimal 0xFE 0x37
 Decimal 254 55
 ASCII 254 "7"

Description

This command will return a hex value corresponding to the the model number of the module see the following table:

Hex	Product ID	Hex	Product ID
1	LCD0821	2	LCD2021
5	LCD2041	6	LCD4021
7	LCD4041	8	LK202-25
9	LK204-25	A	LK404-55
B	VFD2021	C	VFD2041
D	VFD4021	E	VK202-25
F	VK204-25	10	GLC12232
13	GLC24064	14	Unused
15	GLK24064-25	16	Unused
21	Unused	22	GLK12232-25
23	Unused	24	GLK12232-25-SM
25	GLK24064-16-1U-USB	26	GLK24064-16-1U
27	GLK19264-7T-1U-USB	28	GLK12232-16
29	GLK12232-16-SM	2A	GLK19264-7T-1U
2B	LK204-7T-1U	2C	LK204-7T-1U-USB
31	LK404-AT	32	MOS-AV-162A
33	LK402-12	34	LK162-12
35	LK204-25PC	36	LK202-24-USB
37	VK202-24-USB	38	LK204-24-USB
39	VK204-24-USB	3A	PK162-12
3B	VK162-12	3C	MOS-AP-162A
3D	PK202-25	3E	MOS-AL-162A
3F	MOS-AL-202A	40	MOS-AV-202A
41	MOS-AP-202A	42	PK202-24-USB
43	MOS-AL-082	44	MOS-AL-204
45	MOS-AV-204	46	MOS-AL-402
47	MOS-AV-402	48	LK082-12
49	VK402-12	4A	VK404-55
4B	LK402-25	4C	VK402-25
4D	PK204-25	4E	Unused
4F	MOS	50	MOI
51	XBoard-S	52	XBoard-I
53	MOU	54	XBoard-U
55	LK202-25-USB	56	VK202-25-USB
57	LK204-25-USB	58	VK204-25-USB
5B	LK162-12-TC	5C	Unused
71	Unused	72	GLK240128-25
73	LK404-25	74	VK404-25
77	Unused	78	GLT320240
79	GLT480282	7A	GLT240128

Remembered

No

11 Command Summary

11.1 Communications

Description	Syntax	Page	
Changing the I ² C Slave Address	Hexadecimal	0xFE 0x33 [adr]	13
	Decimal	254 51 [adr]	
	ASCII	254 “3” [adr]	
Changing the Baud Rate	Hexadecimal	0xFE 0x39 [speed]	13
	Decimal	254 57 [speed]	
	ASCII	254 “9” [speed]	
Setting a Non-Standard Baud Rate	Hexadecimal	0xFE 0xA4 [speed]	14
	Decimal	254 164 [speed]	

11.2 Text

Description	Syntax	Page	
Auto Scroll On	Hexadecimal	0xFE 0x51	18
	Decimal	254 81	
	ASCII	254 “Q”	
Auto Scroll Off	Hexadecimal	0xFE 0x52	18
	Decimal	254 82	
	ASCII	254 “R”	
Clear Screen	Hexadecimal	0xFE 0x58	18
	Decimal	254 88	
	ASCII	254 “X”	
Changing the Startup Screen	Hexadecimal	0xFE 0x40	18
	Decimal	254 64	
	ASCII	254 “@”	
Set Auto Line Wrap On	Hexadecimal	0xFE 0x43	19
	Decimal	254 67	
	ASCII	254 “C”	
Set Auto Line Wrap Off	Hexadecimal	0xFE 0x44	19
	Decimal	254 68	
	ASCII	254 “D”	
Set Cursor Position	Hexadecimal	0xFE 0x47 [col] [row]	19
	Decimal	254 71 [col] [row]	
	ASCII	254 “G” [col] [row]	
Go Home	Hexadecimal	0xFE 0x48	20
	Decimal	254 72	
	ASCII	254 “H”	

Description	Syntax	Page
Move Cursor Back	Hexadecimal	0xFE 0x4C
	Decimal	254 76
	ASCII	254 “L”
Move Cursor Forward	Hexadecimal	0xFE 0x4D
	Decimal	254 77
	ASCII	254 “M”
Underline Cursor On	Hexadecimal	0xFE 0x4A
	Decimal	254 74
	ASCII	254 “J”
Underline Cursor Off	Hexadecimal	0xFE 0x4B
	Decimal	254 75
	ASCII	254 “K”
Blinking Block Cursor On	Hexadecimal	0xFE 0x53
	Decimal	254 83
	ASCII	254 “S”
Blinking Block Cursor Off	Hexadecimal	0xFE 0x54
	Decimal	254 84
	ASCII	254 “T”

11.3 Special Characters

Description	Syntax	Page
Creating a Custom Character	Hexadecimal	0xFE 0x4E [refID] [data]
	Decimal	254 78 [refID] [data]
	ASCII	254 “N” [refID] [data]
Saving Custom Characters	Hexadecimal	0xFE 0xC1 [Bank] [ID] [Data]
	Decimal	254 193 [Bank] [ID] [Data]
Loading Custom Characters	Hexadecimal	0xFE 0xC0 [Bank]
	Decimal	254 192 [Bank]
Save Startup Screen Custom Characters	Hexadecimal	0xFE 0xC2 [refID] [data]
	Decimal	254 194 [refID] [data]
Initialize Medium Number	Hexadecimal	0xFE 0x6D
	Decimal	254 109
	ASCII	254 “m”
Place Medium Numbers	Hexadecimal	0xFE 0x6F [Row] [Col] [Digit]
	Decimal	254 111 [Row] [Col] [Digit]
	ASCII	254 “o” [Row] [Col] [Digit]
Initialize Horizontal Bar	Hexadecimal	0xFE 0x68
	Decimal	254 104
	ASCII	254 “h”
Place Horizontal Bar Graph	Hexadecimal	0xFE 0x7C [Col] [Row] [Dir] [Length]
	Decimal	254 124 [Col] [Row] [Dir] [Length]
	ASCII	254 “i” [Col] [Row] [Dir] [Length]

Description	Syntax	Page
Initialize Narrow Vertical Bar	Hexadecimal	0xFE 0x73
	Decimal	254 115
	ASCII	254 “s”
Initialize Wide Vertical Bar	Hexadecimal	0xFE 0x76
	Decimal	254 118
	ASCII	254 “v”
Place Vertical Bar	Hexadecimal	0xFE 0x3D [Column] [Length]
	Decimal	254 61 [Column] [Length]
	ASCII	254 “=” [Column] [Length]

11.4 General Purpose Output

Description	Syntax	Page
General Purpose Output Off	Hexadecimal	0xFE 0x56 [Num]
	Decimal	254 86 [Num]
	ASCII	254 “V” [Num]
General Purpose Output On	Hexadecimal	0xFE 0x57 [Num]
	Decimal	254 87 [Num]
	ASCII	254 “W” [Num]
Set Startup GPO state	Hexadecimal	0xFE 0xC3 [Num] [state]
	Decimal	254 195 [Num] [state]

11.5 Display Functions

Description	Syntax	Page
Display On	Hexadecimal	0xFE 0x42 [min]
	Decimal	254 66 [min]
	ASCII	254 “B” [min]
Display Off	Hexadecimal	0xFE 0x46
	Decimal	254 70
	ASCII	254 “F”
Set Brightness	Hexadecimal	0xFE 0x99 [brightness]
	Decimal	254 153 [brightness]
Set and Save Brightness	Hexadecimal	0xFE 0x98 [brightness]
	Decimal	254 152 [brightness]
Set Contrast	Hexadecimal	0xFE 0x50 [contrast]
	Decimal	254 80 [contrast]
	ASCII	254 “P” [contrast]
Set and Save Contrast	Hexadecimal	0xFE 0x91 [contrast]
	Decimal	254 145 [contrast]

11.6 Data Security

Description	Syntax	Page
Set Remember	Hexadecimal 0xFE 0x93 [switch]	32
	Decimal 254 147 [switch]	
Data Lock	Hexadecimal 0xFE 0xCA 0xF5 0xA0 [level]	33
	Decimal 254 202 245 160 [level]	
Set and Save Data Lock	Hexadecimal 0xFE 0xCB 0xF5 0xA0 [level]	34
	Decimal 254 203 245 160 [level]	
Write Customer Data	Hexadecimal 0xFE 0x34 [data]	35
	Decimal 254 52 [data]	
Read Customer Data	ASCII 254 "4" [data]	35
	Hexadecimal 0xFE 0x35	
	Decimal 254 53	
	ASCII 254 "5"	

11.7 Miscellaneous

Description	Syntax	Page
Read Version Number	Hexadecimal 0xFE 0x36	35
	Decimal 254 54	
	ASCII 254 "6"	
Read Module Type	Hexadecimal 0xFE 0x37	36
	Decimal 254 55	
	ASCII 254 "7"	

11.8 Command By Number

Command		Description		Page
Hex	Dec	ASCII		
0x33	51	"3"	Changing the I ² C Slave Address	13
0x34	52	"4"	Write Customer Data	35
0x35	53	"5"	Read Customer Data	35
0x36	54	"6"	Read Version Number	35
0x37	55	"7"	Read Module Type	36
0x39	57	"9"	Changing the Baud Rate	13
0x3D	61	"="	Place Vertical Bar	27
0x40	64	"@"	Changing the Startup Screen	18
0x42	66	"B"	Display On	29
0x43	67	"C"	Set Auto Line Wrap On	19
0x44	68	"D"	Set Auto Line Wrap Off	19
0x46	70	"F"	Display Off	30

Command	Description	Page		
Hex	Dec	ASCII		
0x47	71	“G”	Set Cursor Position	19
0x48	72	“H”	Go Home	20
0x4A	74	“J”	Underline Cursor On	21
0x4B	75	“K”	Underline Cursor Off	21
0x4C	76	“L”	Move Cursor Back	20
0x4D	77	“M”	Move Cursor Forward	20
0x4E	78	“N”	Creating a Custom Character	22
0x50	80	“P”	Set Contrast	31
0x51	81	“Q”	Auto Scroll On	18
0x52	82	“R”	Auto Scroll Off	18
0x53	83	“S”	Blinking Block Cursor On	21
0x54	84	“T”	Blinking Block Cursor Off	21
0x56	86	“V”	General Purpose Output Off	28
0x57	87	“W”	General Purpose Output On	28
0x58	88	“X”	Clear Screen	18
0x68	104	“h”	Initialize Horizontal Bar	26
0x6D	109	“m”	Initialize Medium Number	25
0x6F	111	“o”	Place Medium Numbers	25
0x73	115	“s”	Initialize Narrow Vertical Bar	26
0x76	118	“v”	Initialize Wide Vertical Bar	27
0x7C	124	“ ”	Place Horizontal Bar Graph	26
0x91	145		Set and Save Contrast	31
0x93	147		Set Remember	32
0x98	152		Set and Save Brightness	30
0x99	153		Set Brightness	30
0xA4	164		Setting a Non-Standard Baud Rate	14
0xC0	192		Loading Custom Characters	24
0xC1	193		Saving Custom Characters	23
0xC2	194		Save Startup Screen Custom Characters	24
0xC3	195		Set Startup GPO state	29

12 Appendix

12.1 Specifications

12.1.1 Environmental

Table 56: Environmental Specifications

	Standard Temperature	Extended Temperature
Operating Temperature	0°C to +50°C	-20°C to +70°C
Storage Temperature	-20°C to +70°C	-30°C to +80°C
Operating Relative Humidity	90% max non-condensing	
Vibration (Operating)	4.9 m/s ² XYZ directions	
Vibration (Non-Operating)	19.6 m/s ² XYZ directions	
Shock (Operating)	29.4 m/s ² XYZ directions	
Shock (Non-Operating)	490 m/s ² XYZ directions	

12.1.2 Electrical

Table 57: Electrical Specifications

	Standard	Wide Voltage (V)
Supply Voltage	+5Vdc ±0.25V	+9V to +15V
Minimum Current	45mA typical	
Backlight On (YG & IY)	add 65mA (110mA) typical	
Backlight On (R)	add 60mA (105mA) typical	
Backlight On (GW & WB)	add 20mA (65mA) typical	

12.1.3 Optical

Table 58: Optical Specifications

Character x Lines	8 columns x 2 rows
Module Size	58.00mm x 32.00mm x 26.80mm
Character Size	2.96mm x 5.56mm
Display Size	27.80mm x 11.49mm
LED Backlight Half-Life (YG & IY)	50,000 hours typical
LED Backlight Half-Life (R)	20,000 hours typical
LED Backlight Half-Life (GW & WB)	10,000 hours typical

NOTE To prolong life, it is recommended that the backlight be turned off when the display is not in use.

12.2 Physical Layout

Figure 18: Physical Diagram

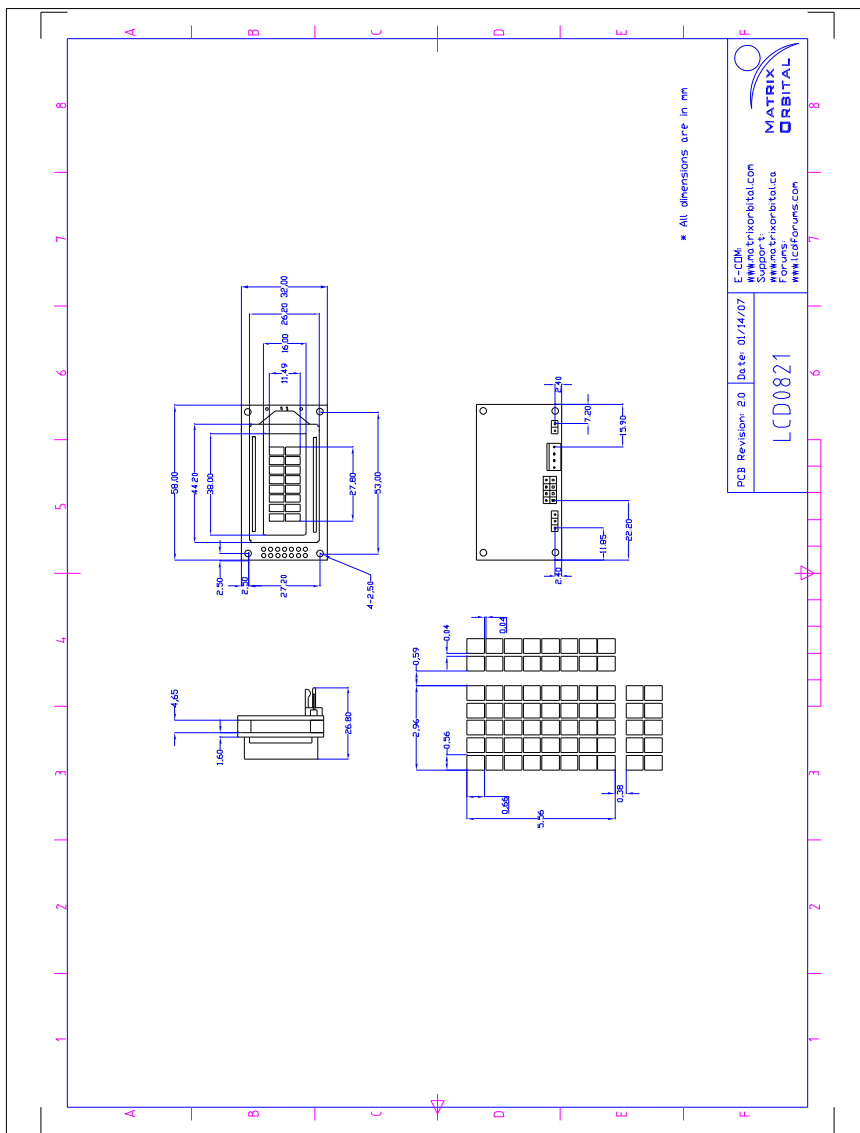

12.3 Ordering Information

LCD	08	2	1	-R	-V	-E
1	2	3	4	5	6	7

Table 59: Part Numbering Scheme

#	Description	Options
1	Screen Type	LCD: Liquid Crystal Display
2	Width	08: Eight Character Columns
3	Height	2: Two Character Rows
4	GPO	1: Single GPO
5	Color (Text/Background)	NP: Standard Grey/Yellow-Green GW: Grey/White WB: White/Blue R: Red/Black IY: Yellow/Black
6	Input Voltage	NP: Standard (4.75-5.25V) -V: Extended Volatge (9.00-15.0V)
7	Temperature	NP: Standard (0°C to +50°C) -E: Extended Temperature (-20°C to +70°C)

Table 60: Part Options

12.4 Definitions

E Extended Temperature (-20C to 70C)

V Wide Voltage (+9 to +15Vdc)

GW Grey Text / White Background

WB White Text / Blue Background

R Inverse Red

IY Inverse Yellow

MSB Most Significant Byte

LSB Least Significant Byte

12.5 Contacting Matrix Orbital

Telephone

Sales: 1(403)229-2737

Support: 1(403)204-3750

On The Web

Sales: <http://www.MatrixOrbital.com>

Support: <http://www.MatrixOrbital.ca>

Forums: <http://www.lcdforums.com>

12.6 Revision History

Table 61: Revision History

Revision	Description	Author
2.0	Initial Manual	Matrix Orbital
2.1	Updated Backlight Life	Clark