

CPDH5V0U RoHS Device



Features

- Uni-directional ESD protection.
- IEC61000-4-2 Level 4 ESD protection.
- Surface mount package.
- High component density.

Mechanical data

- Case: SOD-523 standard package , molded plastic.
- Terminals: Tin plated, solderable per MIL-STD-750,method 2026.
- Marking code: E5
- Mounting position: Any
- Weight: 0.0012 gram(approx.).

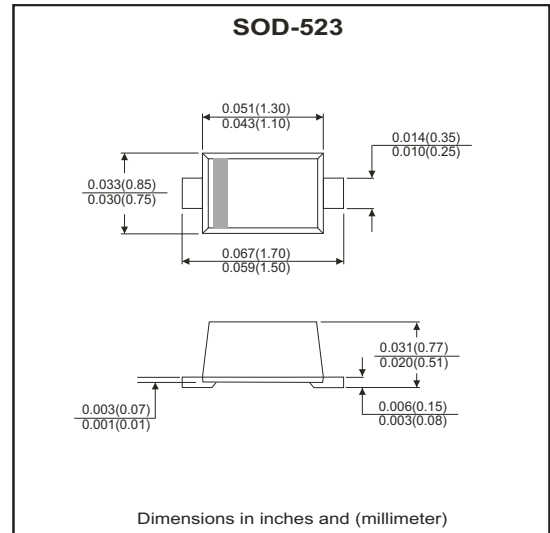

Circuit Diagram



Maximum Rating and Electrical Characteristics

(at TA=25°C unless otherwise noted)

Parameter	Conditions	Symbol	Min	Typ	Max	Unit
Forward voltage	I _F = 10mA	V _F		0.8		V
Diode breakdown voltage	I _R = 1mA	V _{BD}	6			V
Leakage current	V _R = 5V	I _L		0.3	2.0	uA
Junction capacitance	V _R = 0V, f = 1MHz	C _T		90	120	pF
ESD capability	IEC 61000-4-2(air) IEC 61000-4-2(contact)	ESD			20 15	kV
Clamping voltage	I _{PP} = 5A, T _P =8/20us I _{PP} = 16A, T _P =8/20us	V _C			9.8 12.5	V
Peak pulse power		P _{PP}			200	W
Operation temperature		T _J			125	°C
Storage temperature		T _{STG}	-55		150	°C

RATING AND CHARACTERISTIC CURVES (CPDH5V0U)

Fig.1- 8/20us Peak pulse current wave form acc. IEC 61000-4-5

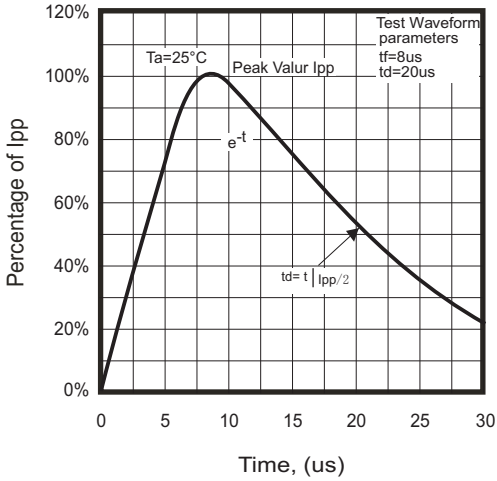

Fig. 2 - Power rating derating curve

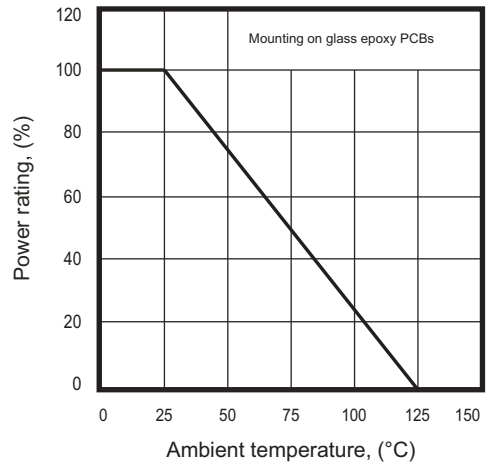

Fig. 3 - Clamping voltage vs. peak pulse current

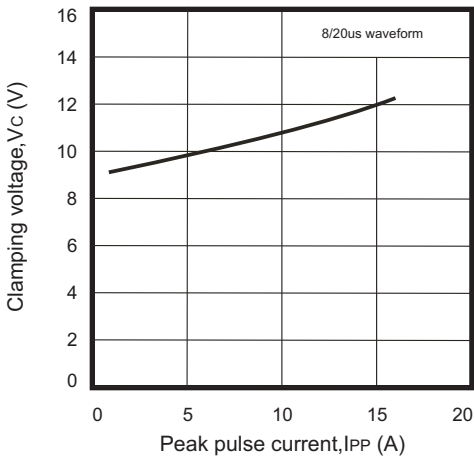

Fig. 4 - Forward voltage vs. forward current

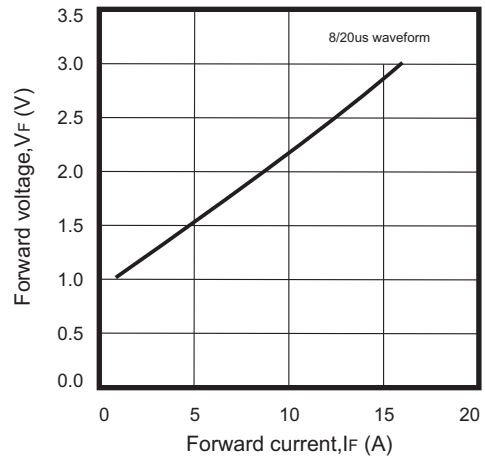
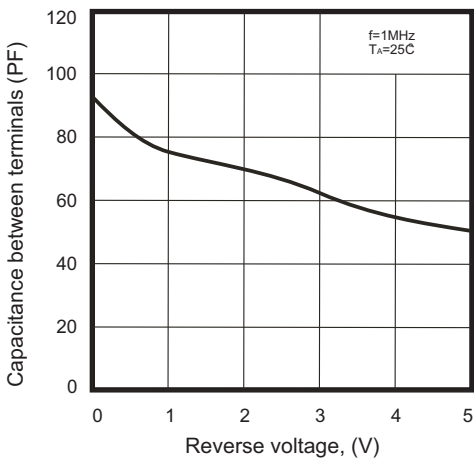
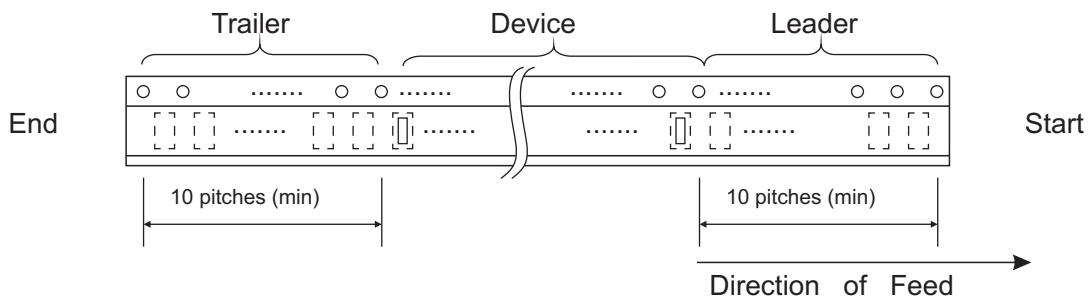
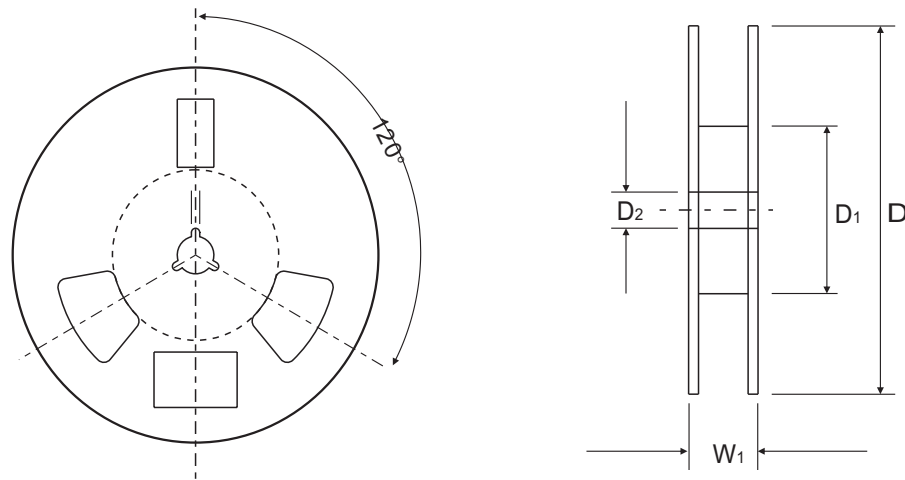
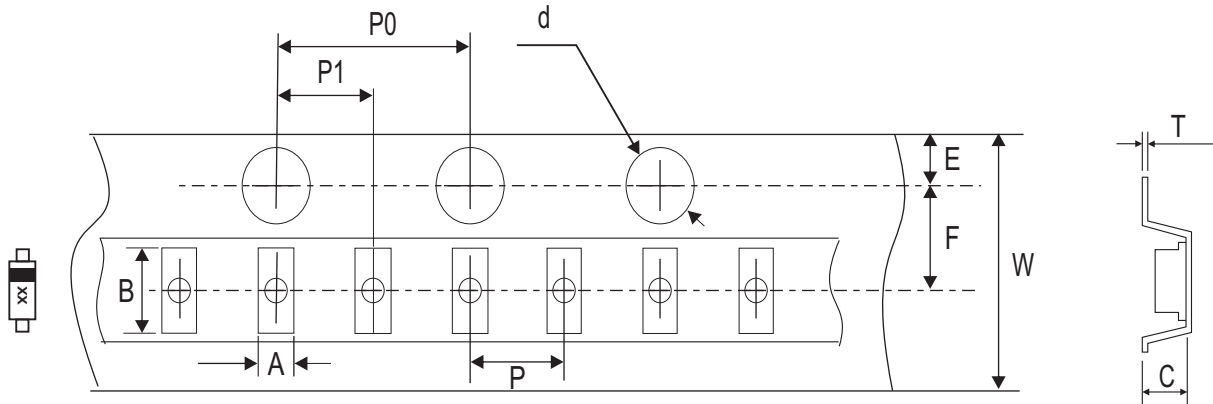

Fig. 5 - Capacitance between terminals characteristics



Reel Taping Specification



SOD-523	SYMBOL	A	B	C	d	D	D ₁	D ₂
	(mm)	0.90 ± 0.05	1.94 ± 0.05	0.73 ± 0.05	1.50 ± 0.10	178 ± 2.00	54.40 ± 1.00	13.00 ± 1.00
	(inch)	0.035 ± 0.002	0.076 ± 0.002	0.029 ± 0.002	0.059 ± 0.004	7.008 ± 0.079	2.142 ± 0.039	0.511 ± 0.039

SOD-523	SYMBOL	E	F	P	P ₀	P ₁	W	W ₁
	(mm)	1.75 ± 0.10	3.50 ± 0.10	2.00 ± 0.10	4.00 ± 0.10	2.00 ± 0.10	8.00 ± 0.30 / - 0.10	12.30 ± 1.0
	(inch)	0.069 ± 0.004	0.138 ± 0.004	0.157 ± 0.004	0.157 ± 0.004	0.079 ± 0.004	0.315 ± 0.012 / - 0.004	0.484 ± 0.039

Marking Code

Part Number	Marking Code
CPDH5V0U	E5



Suggested PAD Layout

SIZE	SOD-523	
	(mm)	(inch)
A	1.42	0.055
B	0.60	0.024
C	0.70	0.028
D	2.02	0.079
E	0.82	0.031

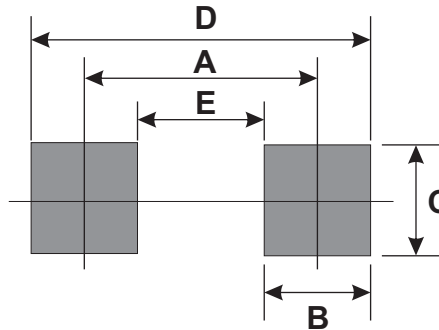

Standard Packaging

Case Type	REEL PACK	
	REEL (pcs)	Reel Size (inch)
SOD-523	3,000	7