

## DETAILS

<b>Product Number</b>	FC15004_FLORENTINA-WW
<b>Family</b>	Florentina
<b>Type</b>	Assembly
<b>Color</b>	black
<b>Diameter</b>	28,81x286,8 mm
<b>Height</b>	25,1 mm
<b>Style</b>	rectang
<b>Optic Material</b>	
<b>Holder Material</b>	
<b>Fastening</b>	
<b>Status</b>	production ready
<b>ROHS Compliant</b>	Yes
<b>Date Updated</b>	20/09/2016



## OPTICAL PROPERTIES

LED	Viewing Angle	Light Beam	Efficiency	cd/lm	Connector
XP-E2	52 deg	Very Wide	77 %	1.100	-
XP-G2	59 deg	Very Wide	78 %	0.900	-
H35C1 (LEMWA33)	56 deg	Very Wide	77 %	0.970	-
LUXEON Rebel Plus	40 deg	Very Wide	79 %	1.300	-
LUXEON TX	41 deg	Very Wide	78 %	1.300	-
LUXEON Rebel ES	46 deg	Very Wide	77 %	1.200	-
LUXEON Z ES	33 deg	Very Wide	80 %	1.580	-
NCSxx19B	38 deg	Very Wide	76 %	1.400	-
NVSxx19B/NVSxx19C	46 deg	Very Wide	74 %	1.130	-
Oslon SSL 80	47 deg	Very Wide	75 %	sim: 1.100	-
Oslon Square EC	57 deg	Very Wide	76 %	0.950	-
Oslon SSL 150	37 deg	Very Wide	79 %	1.500	-
LH351B	64 deg	Very Wide	77 %	0.820	-
TL1L4	48 deg	Very Wide	78 %	1.130	-

11x23.833=262.16

Led middle position

Isometric view (1:2)

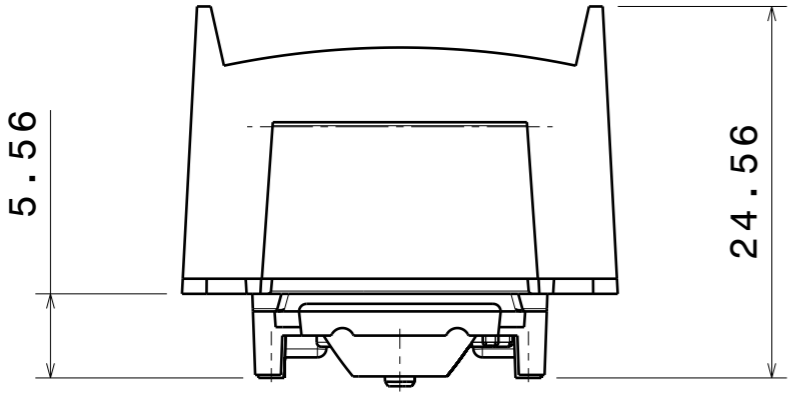
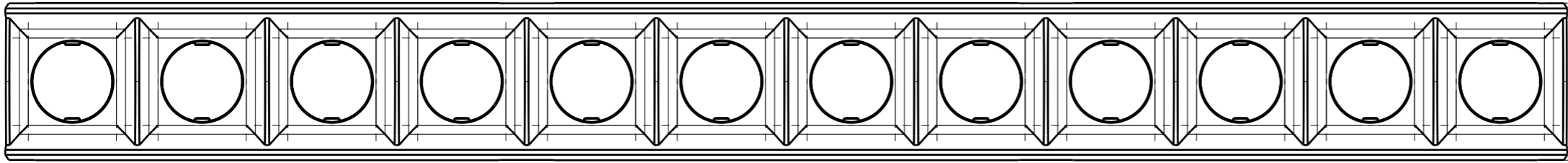
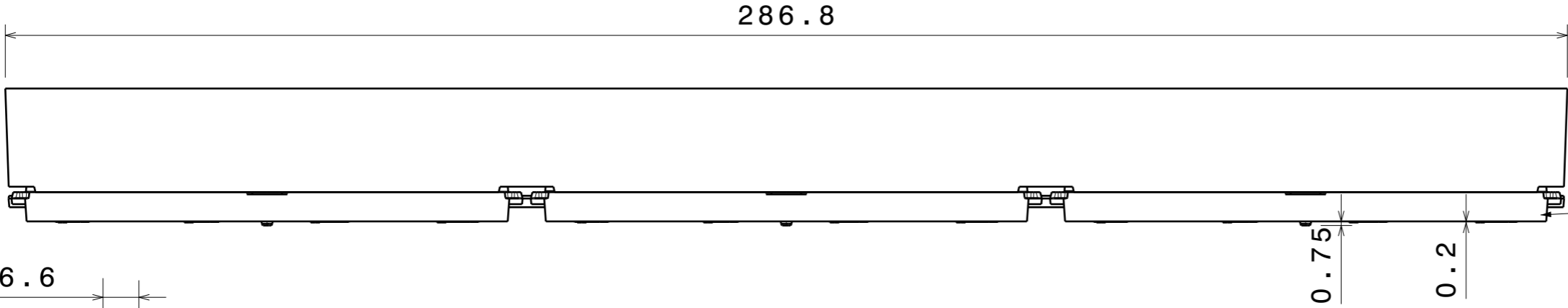
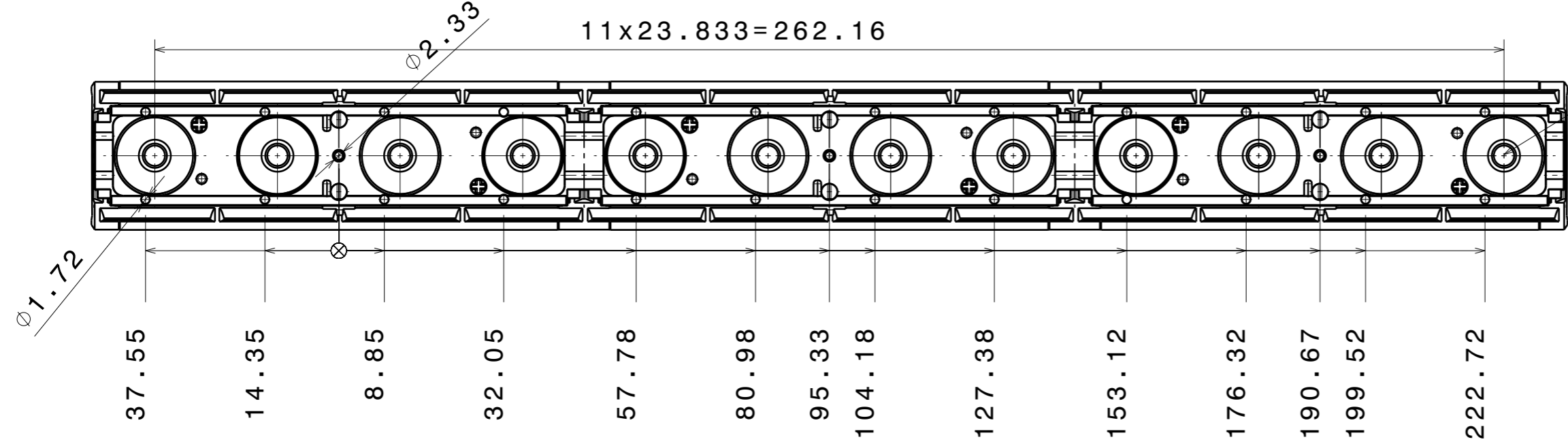

Scale 2:1

INDEX	PART NO	DESCRIPTION	MATERIAL	COLOUR
1	C14446	FLORENTINA-SHD	PC Makrolon 2407	black
2	C14445	FLORENTINA-HLD	PC Makrolon 2407	black
3	F11007	TINA-WW(12pcs)	PMMA	clear

Tolerances if not otherwise shown  
According to DIN ISO 2768-1  
Linear measures:  
up to 30mm class M, otherwise class C  
According to DIN ISO 2768-2  
Form and position: class L

**LEDiL** Ledil Oy  
Salorankatu 10  
FIN 24240 SALO  
Finland

THIRD ANGLE PROJECTION:

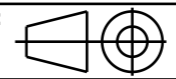

DRAWING TITLE  
**FC15004\_FLORENTINA-WW**

This drawing is the property of LEDiL Oy. It may not be reproduced, copied or communicated without a written agreement with LEDiL Oy.

SIZE PART NUMBER  
**A3 FC15004**

SCALE 1:1 WEIGHT 69,3 g SHEET 1/1

# Ledil FC15004\_FLORENTINA-WW\_(XP-E2) / LDC (Linear)

Luminaire: Ledil FC15004\_FLORENTINA-WW\_(XP-E2)

Lamps: 1 x Cree\_XP-E2\_x12\_(XPEBWT-H1-7A2-Q3-0-03)\_919.369lm@250mA\_P=8.6517W\_I=0.25A

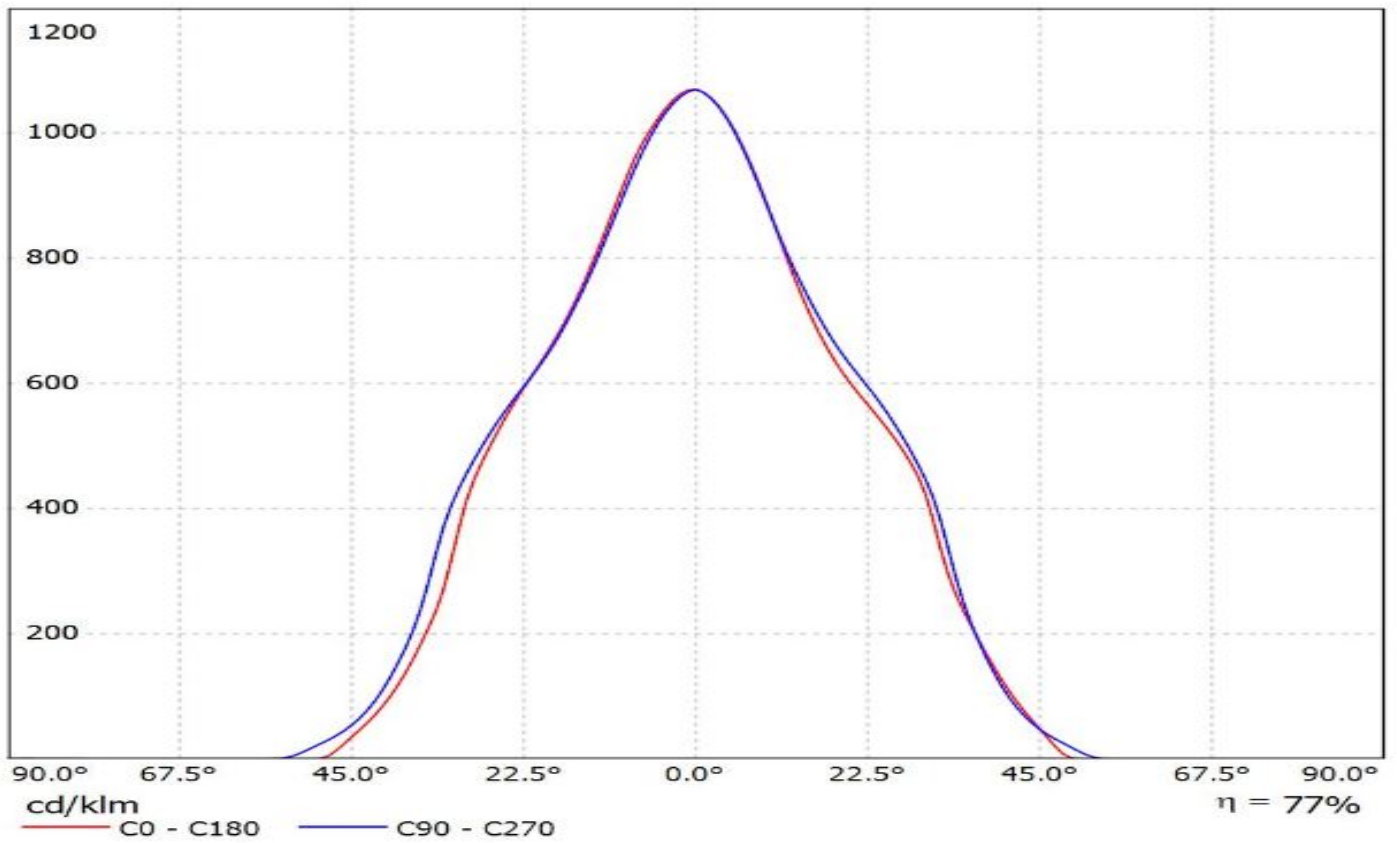

Luminaire: Ledil FC15004\_FLORENTINA-WW\_(XP-G2)

Lamps: 1 x Cree\_XP-G2\_(XPGBWT-01-4A0-R3-0-01)\_1166.49lm@250mA\_P=8.4705W\_I=0.25A

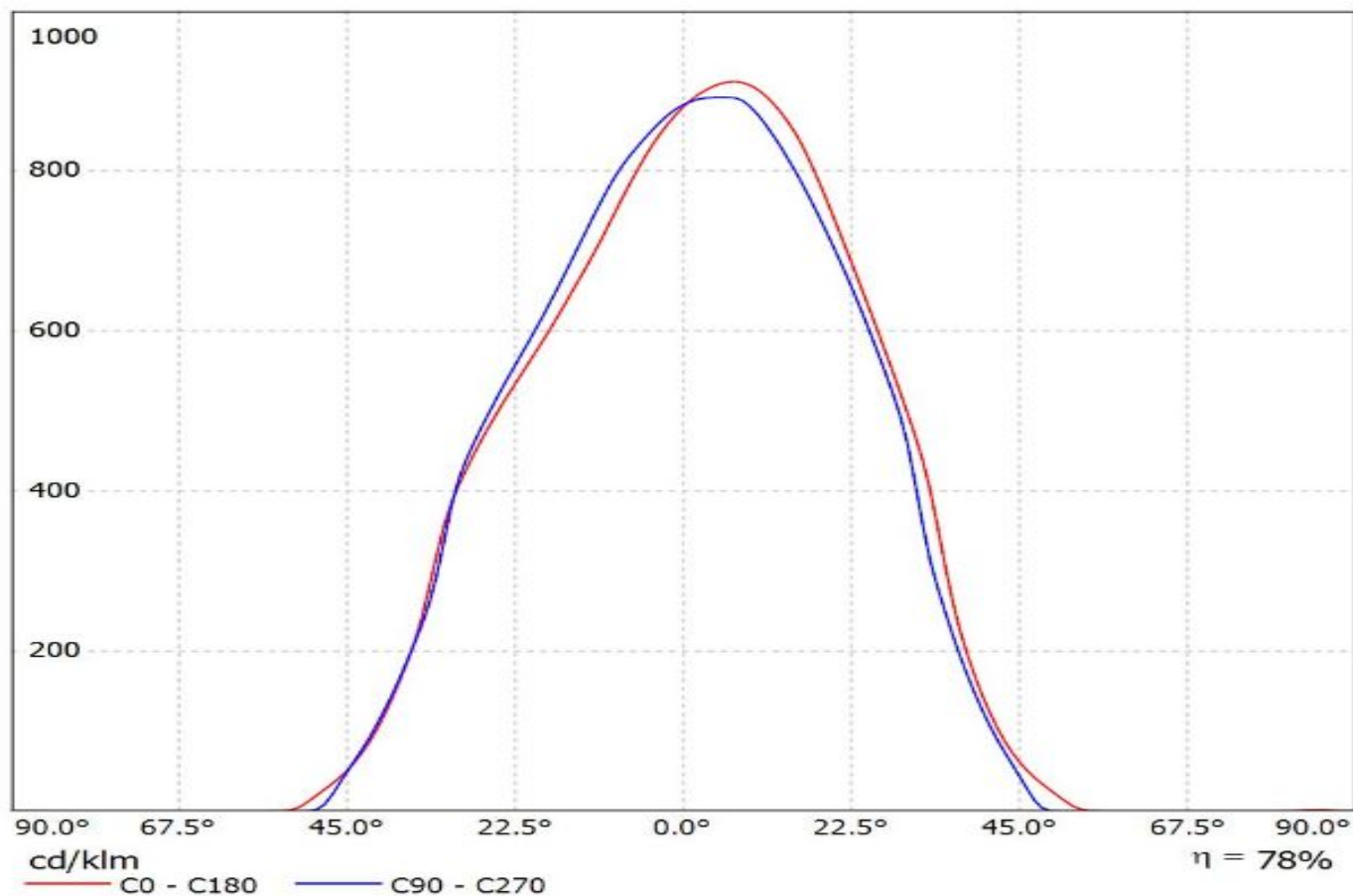

Luminaire: Ledil FC15004\_FLORENTINA-WW\_(LG\_H35C1)  
Lamps: 1 x LG\_H35C1\_x12\_1386.4lm@250mA\_P=8.5608W\_I=0.25A

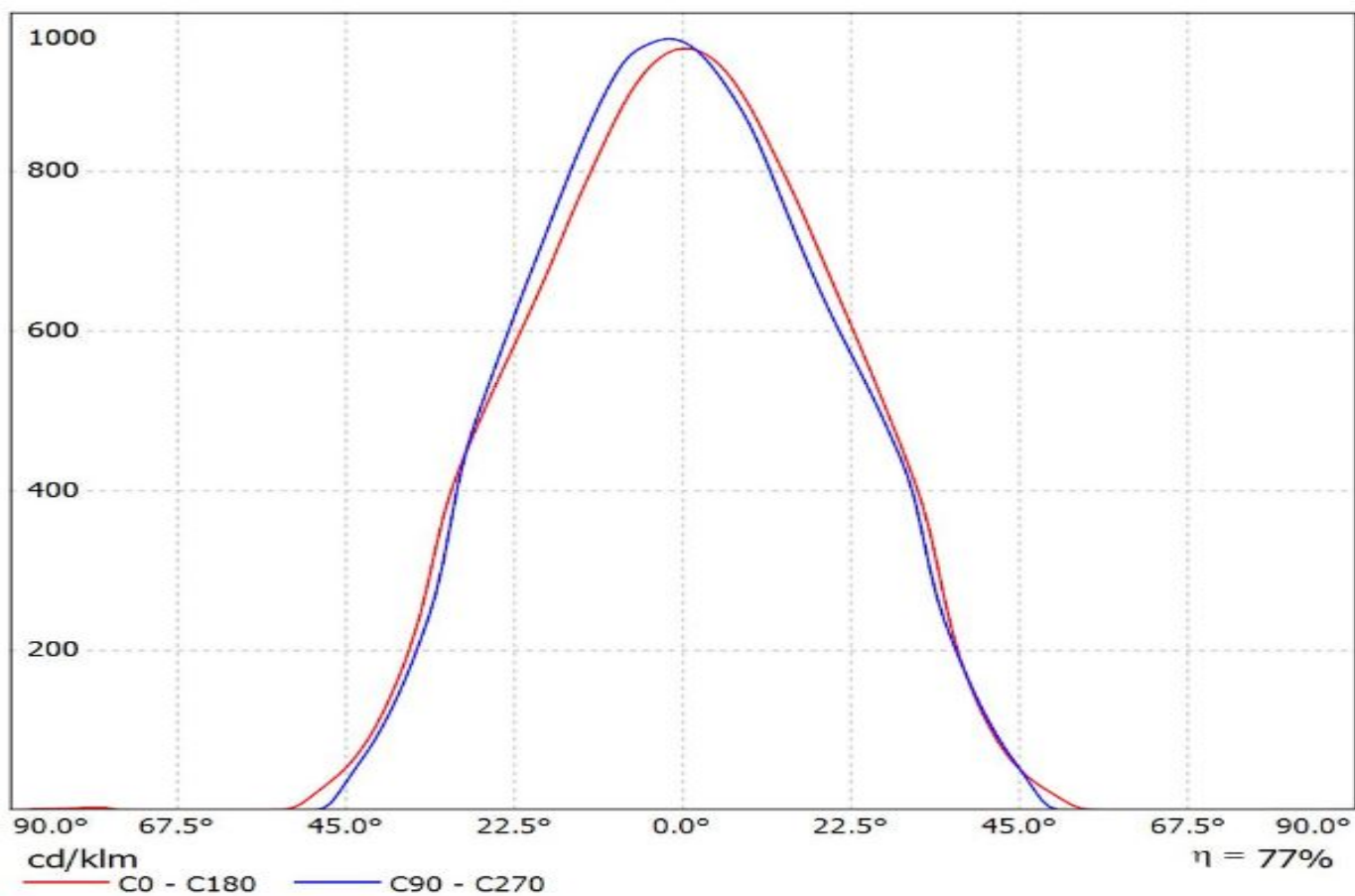

# Ledil FC15004\_FLORENTINA-WW\_(Rebel\_Plus) / LDC (Linear)

Luminaire: Ledil FC15004\_FLORENTINA-WW\_(Rebel\_Plus)

Lamps: 1 x Luxeon\_Rebel\_Plus\_x12\_(LX18-P140-3)

\_1023.73lm@250mA\_CCT=4000K\_P=8.4525W\_I=0.25A

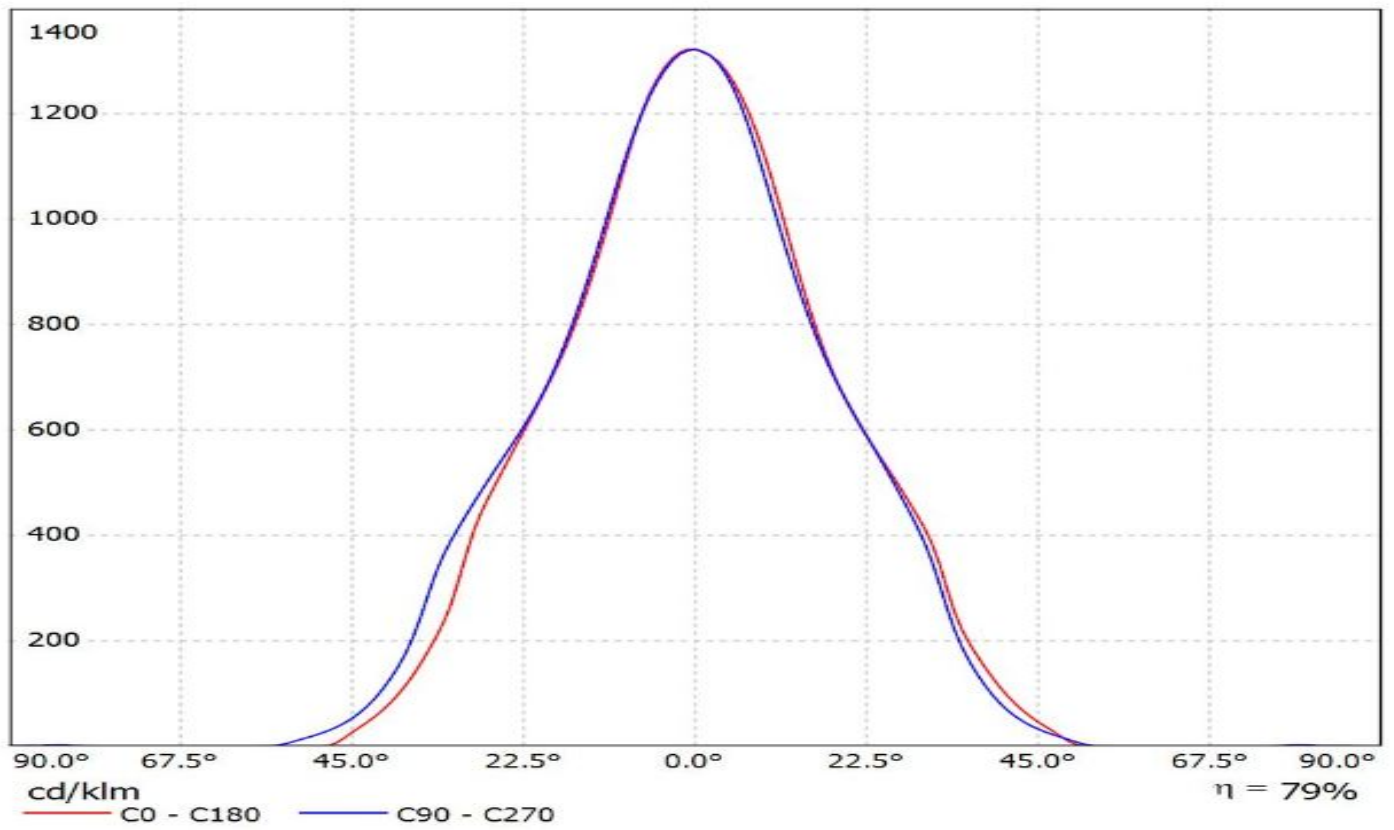

# Ledil FC15004\_FLORENTINA-WW\_(Luxeon\_TX) / LDC (Linear)

Luminaire: Ledil FC15004\_FLORENTINA-WW\_(Luxeon\_TX)

Lamps: 1 x Luxeon\_TX\_x12\_(L1T2-5770)\_1350.11lm@250mA\_CCT=5700K\_P=8.3223W\_I=0.25A

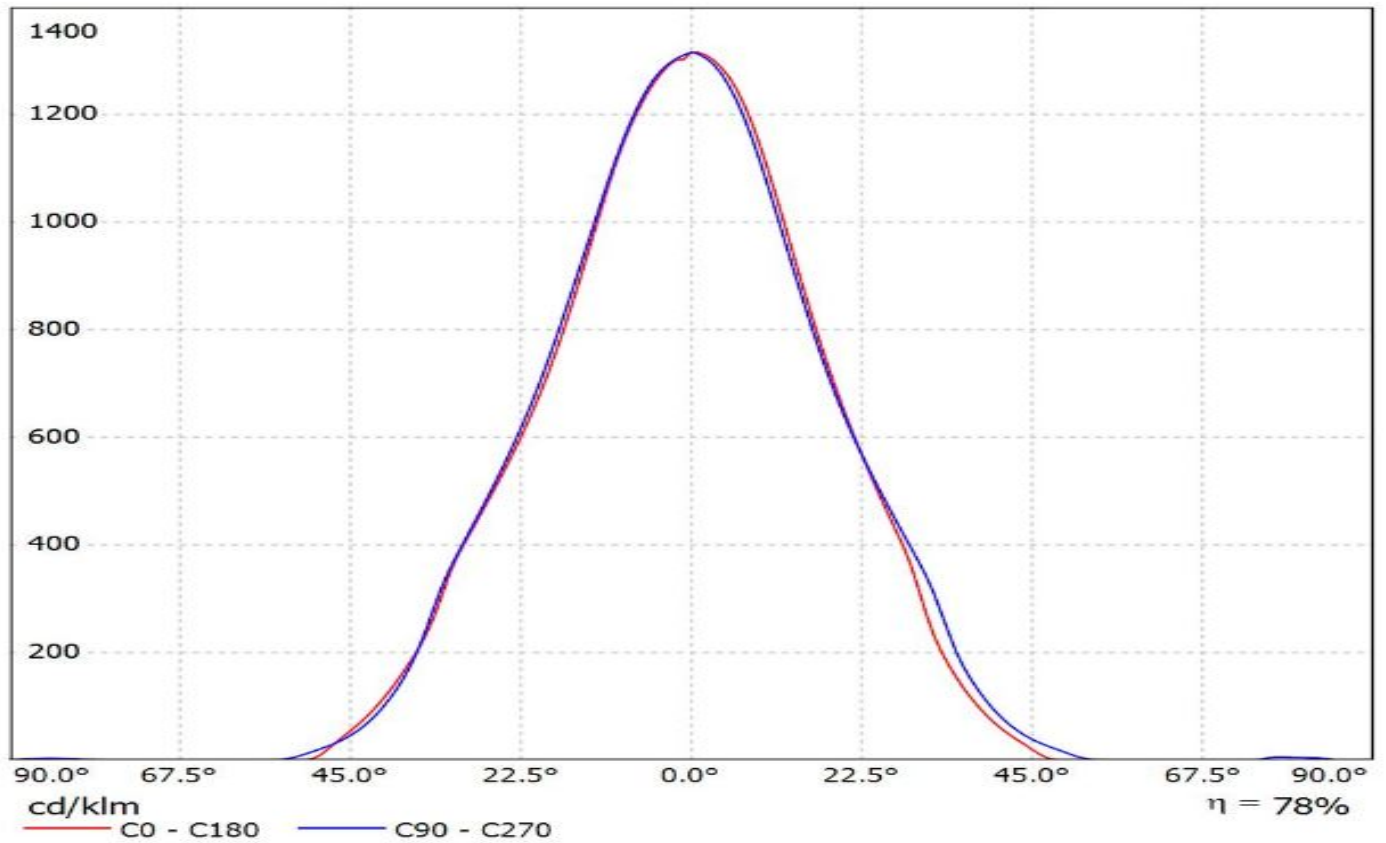

# Ledil FC15004\_FLORENTINA-WW\_(Rebel\_ES) / LDC (Linear)

Luminaire: Ledil FC15004\_FLORENTINA-WW\_(Rebel\_ES)

Lamps: 1 x Luxeon\_Rebel\_ES\_x12\_(LXML-PWC2)\_1133.87lm@250mA\_P=8.6613W\_I=0.25A

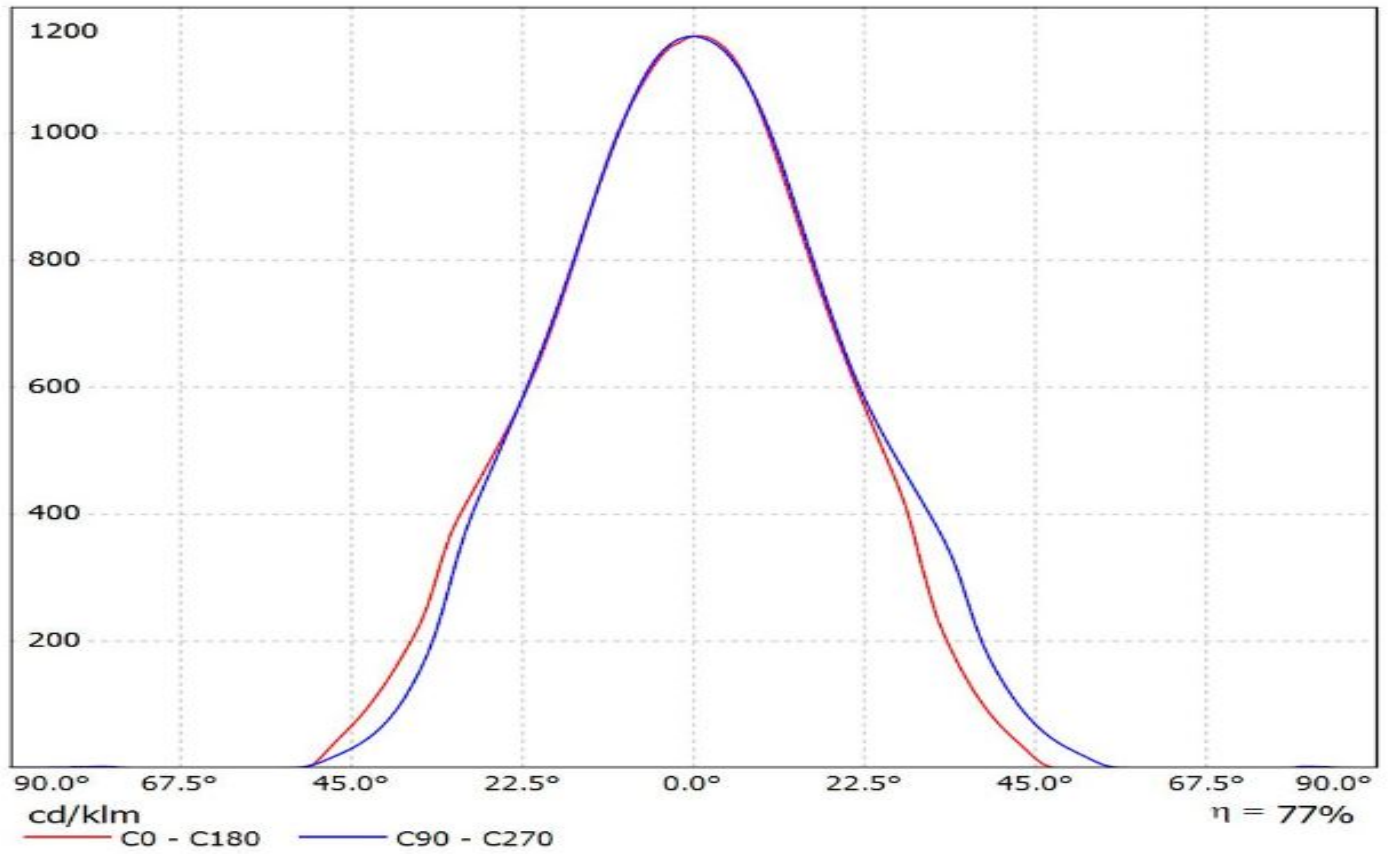



Luminaire: Ledil FC15004\_FLORENTINA-WW\_(Luxeon\_Z-ES)  
Lamps: 1 x Luxeon\_Z-ES\_x12\_934.806@250mA\_P=8.3W\_I=0.25A

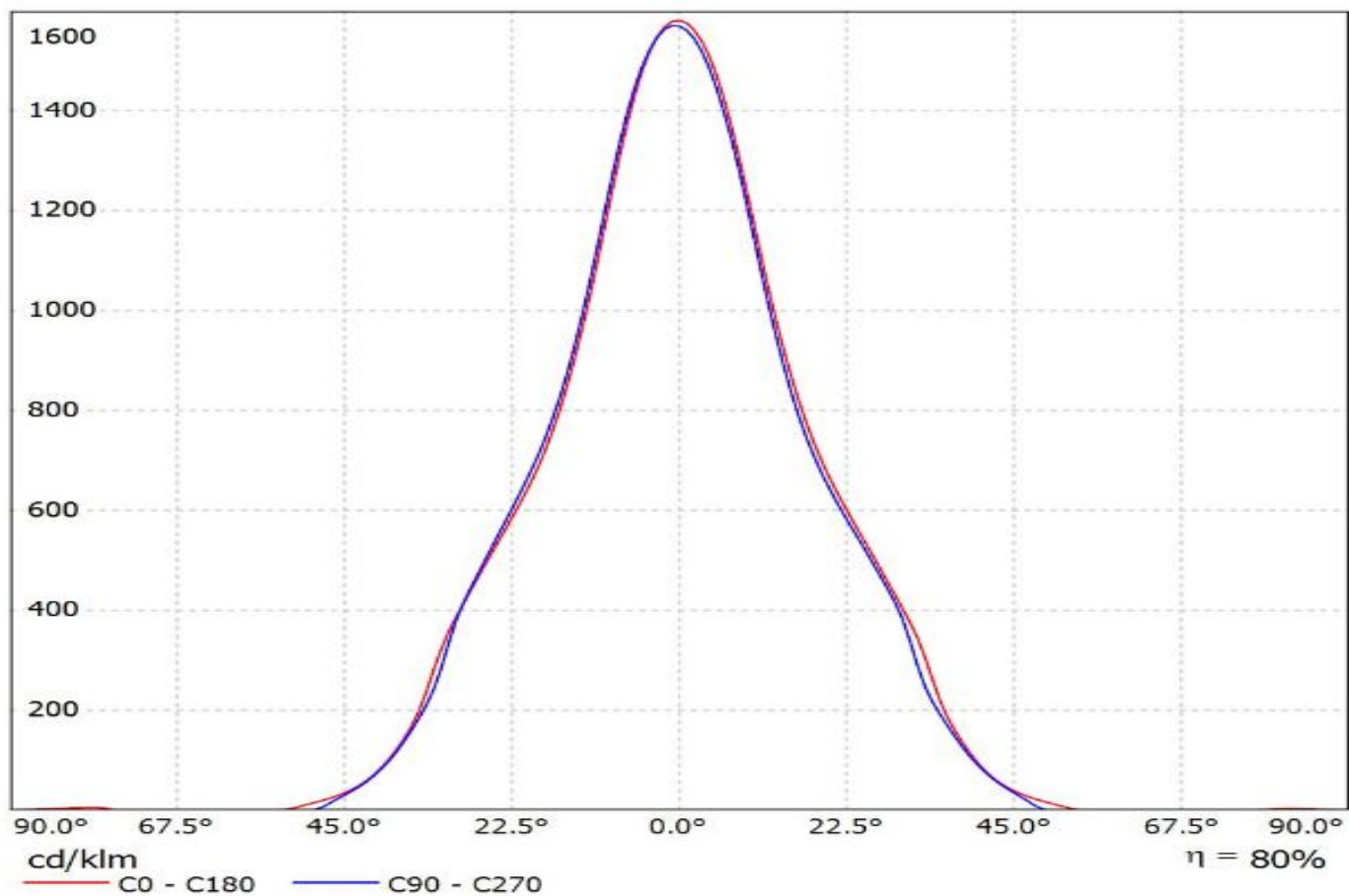

# Ledil FC15004\_FLORENTINA-WW\_(NCSxx19B) / LDC (Linear)

Luminaire: Ledil FC15004\_FLORENTINA-WW\_(NCSxx19B)

Lamps: 1 x Nichia\_NCSxx19B\_x12\_(NCSL219B)\_936.422lm@250mA\_P=8.9525W\_I=0.25A

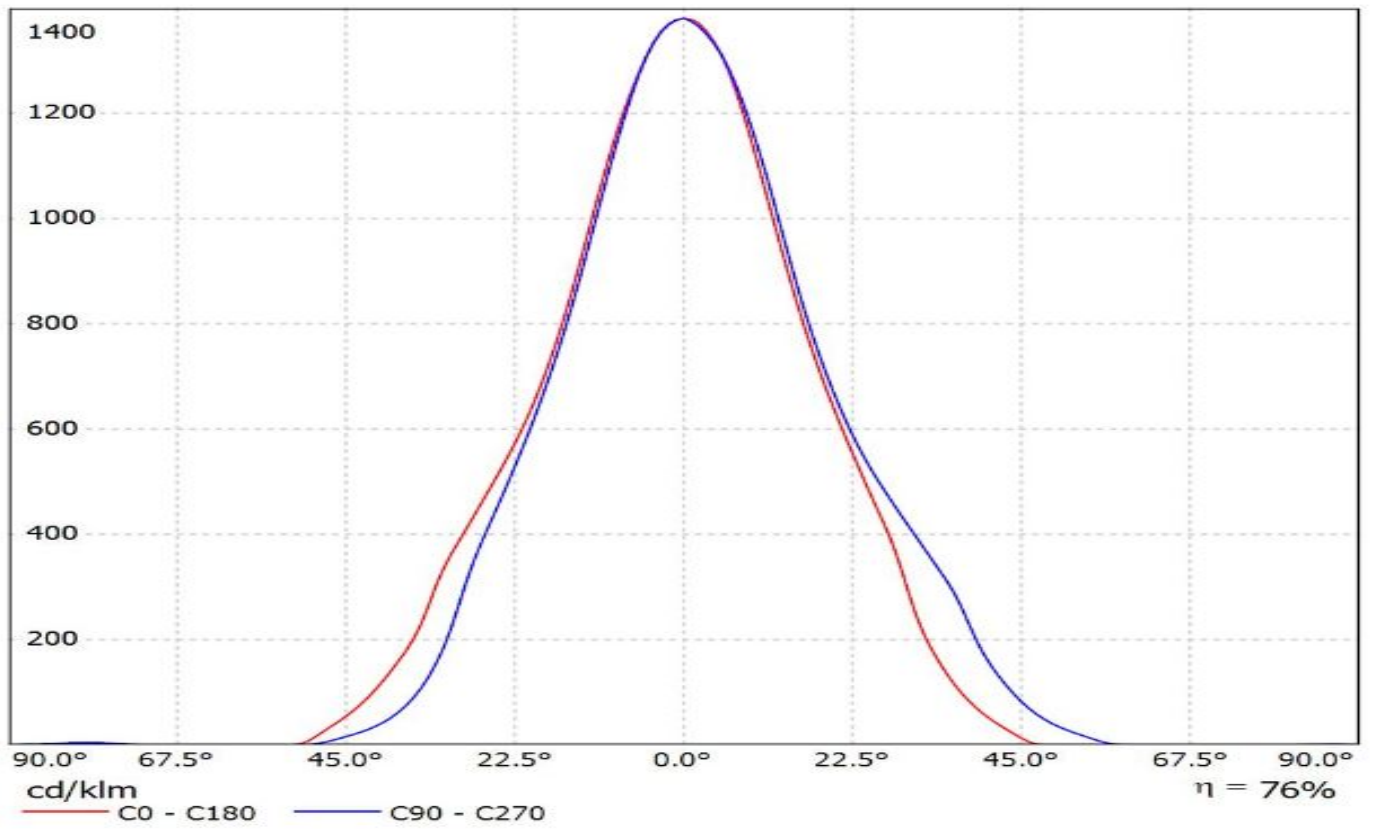

Luminaire: Ledil FC15004\_FLORENTINA-WW\_(NVSL219B)

Lamps: 1 x Nichia\_NVSL219B\_x12\_1040.35@250mA\_P=8.6165W\_I=0.25A

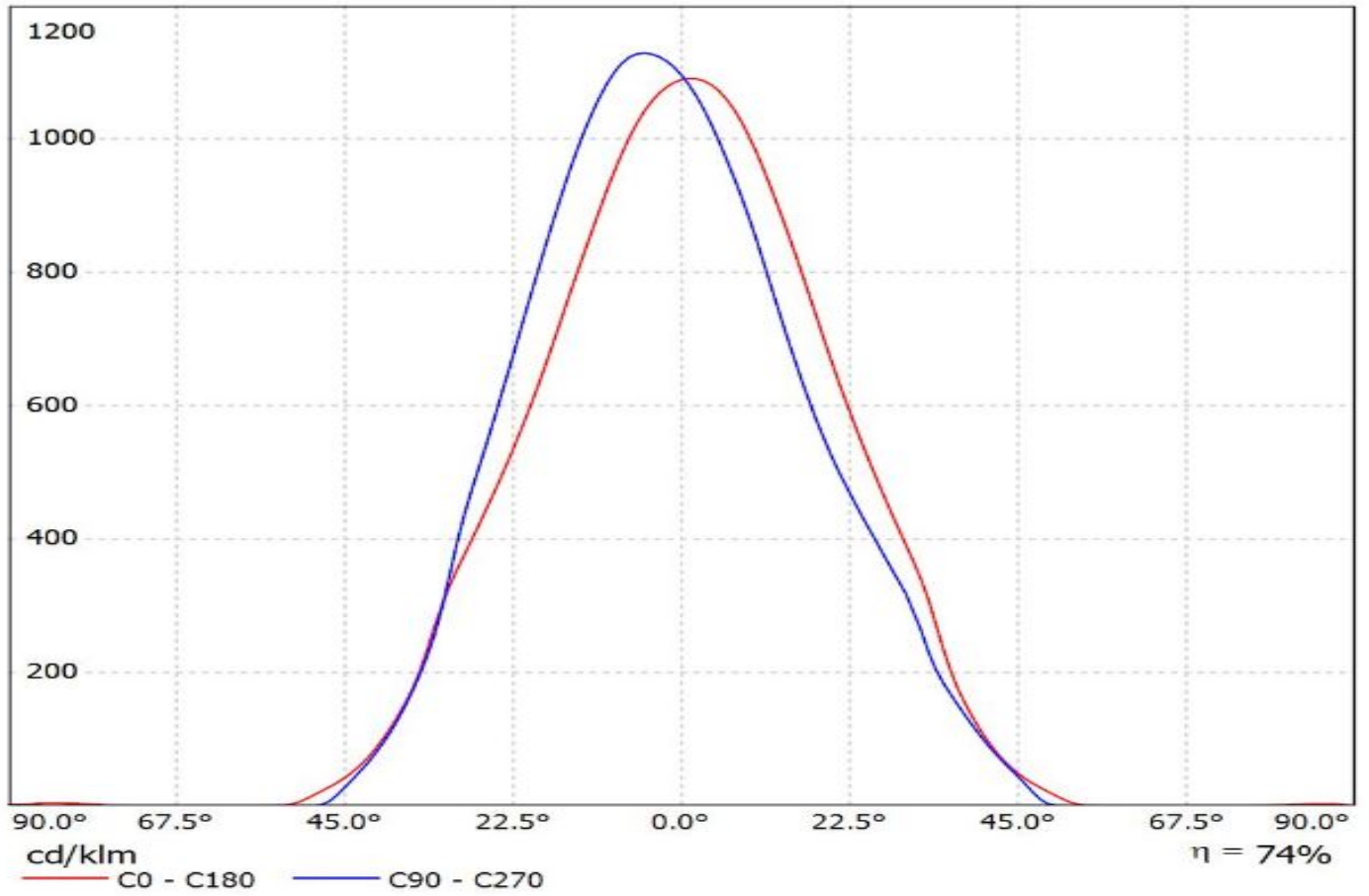

# Ledil FC15004\_FLORENTINA-WW\_(SSL80) / LDC (Linear)

Luminaire: Ledil FC15004\_FLORENTINA-WW\_(SSL80)

Lamps: 1 x Oslon\_SSL80\_x12\_(LCW\_CQ7P.ĚC)\_826.663lm@250mA\_P=9.3033W\_I=0.25A

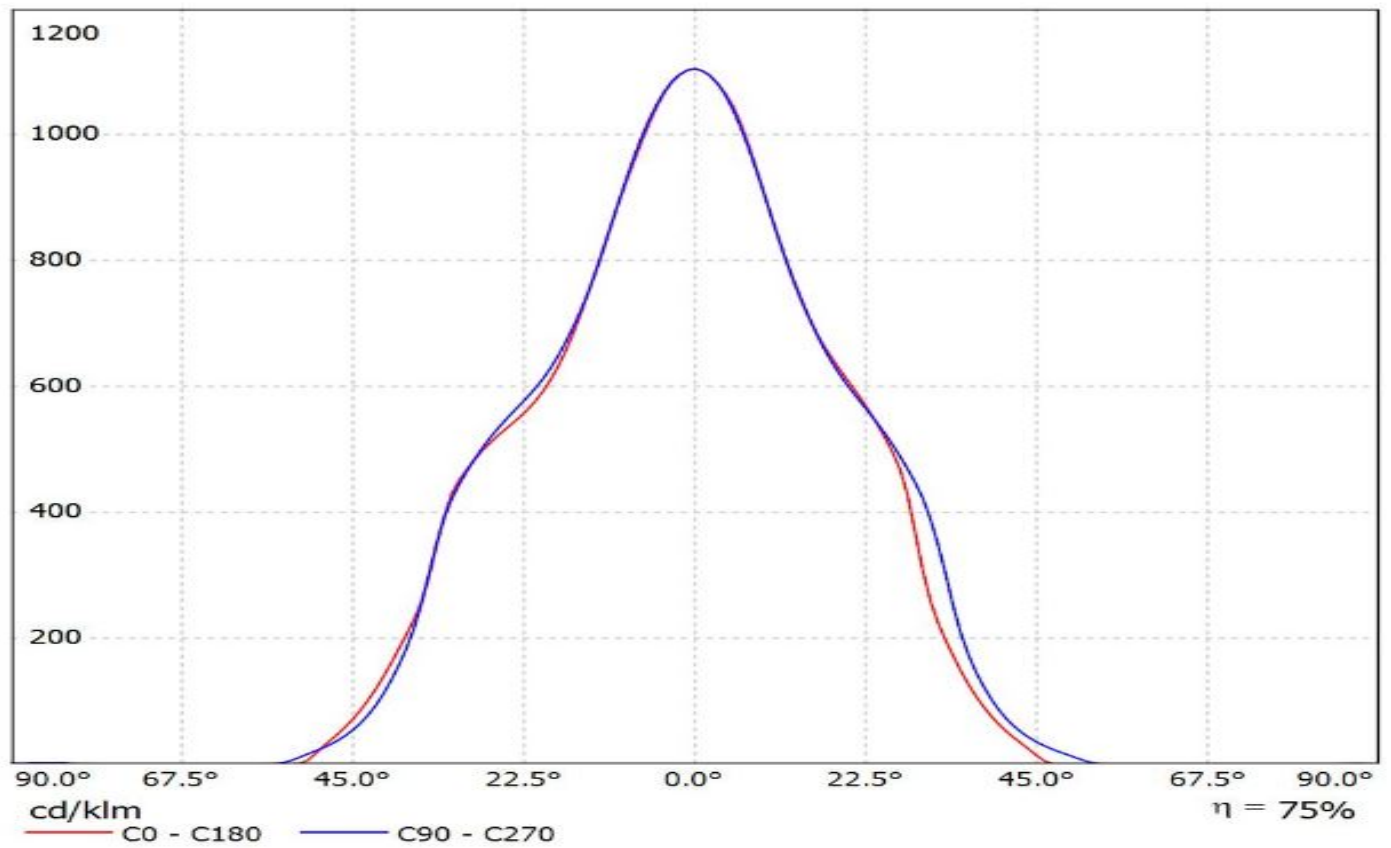

Luminaire: Ledil FC15004\_FLORENTINA-WW\_(SQ-EC)

Lamps: 1 x OSLO<sub>N</sub>\_SQUARE-EC\_x12\_1046.45lm@250mA\_P=8.3193W\_I=0.25A

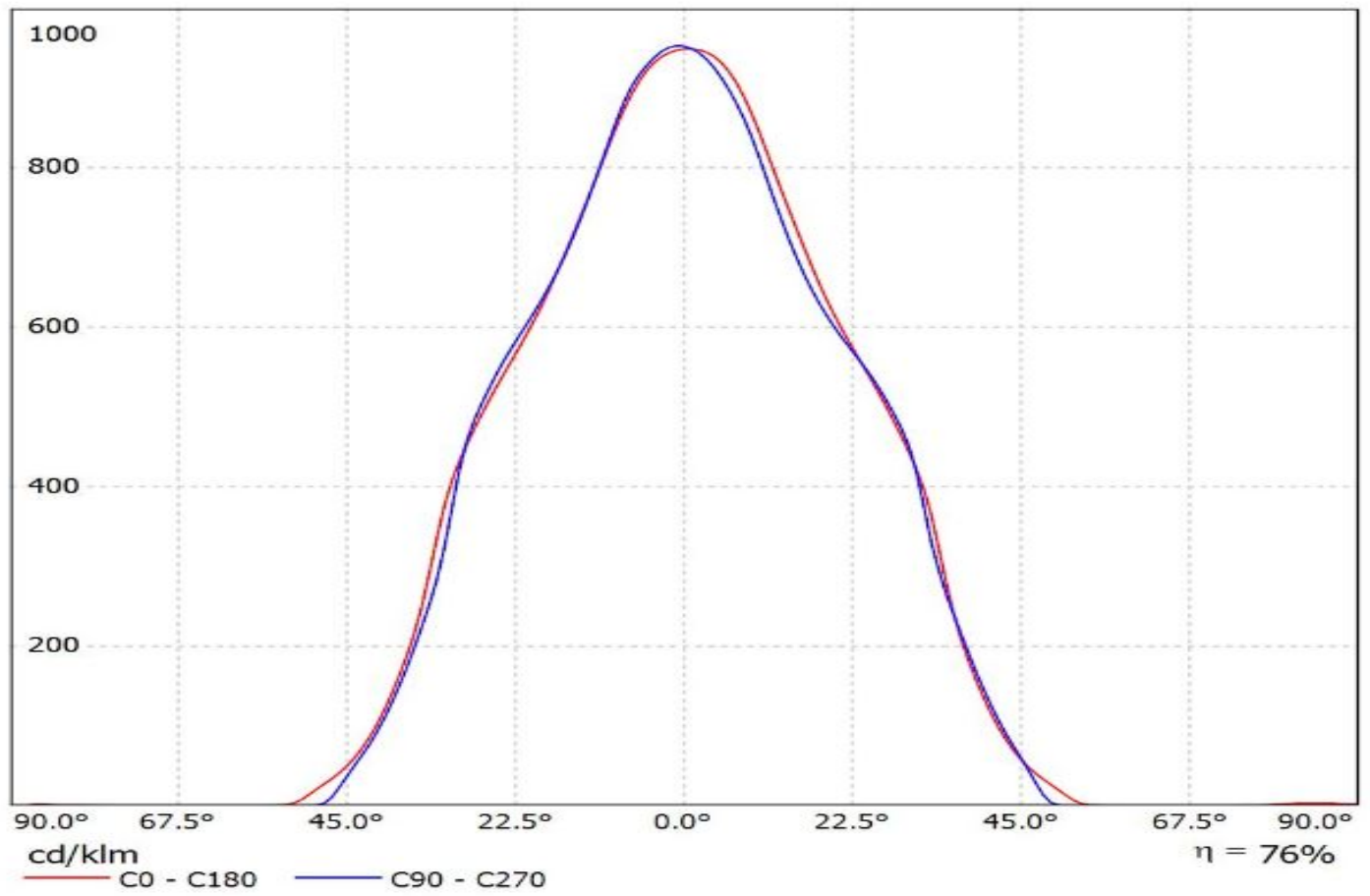

Luminaire: Ledil FC15004-FLORENTINA-WW\_(SSL150)  
Lamps: 1 x Oslon\_SSL150\_995.439lm@250mA\_P=8.4375W\_I=0.25A

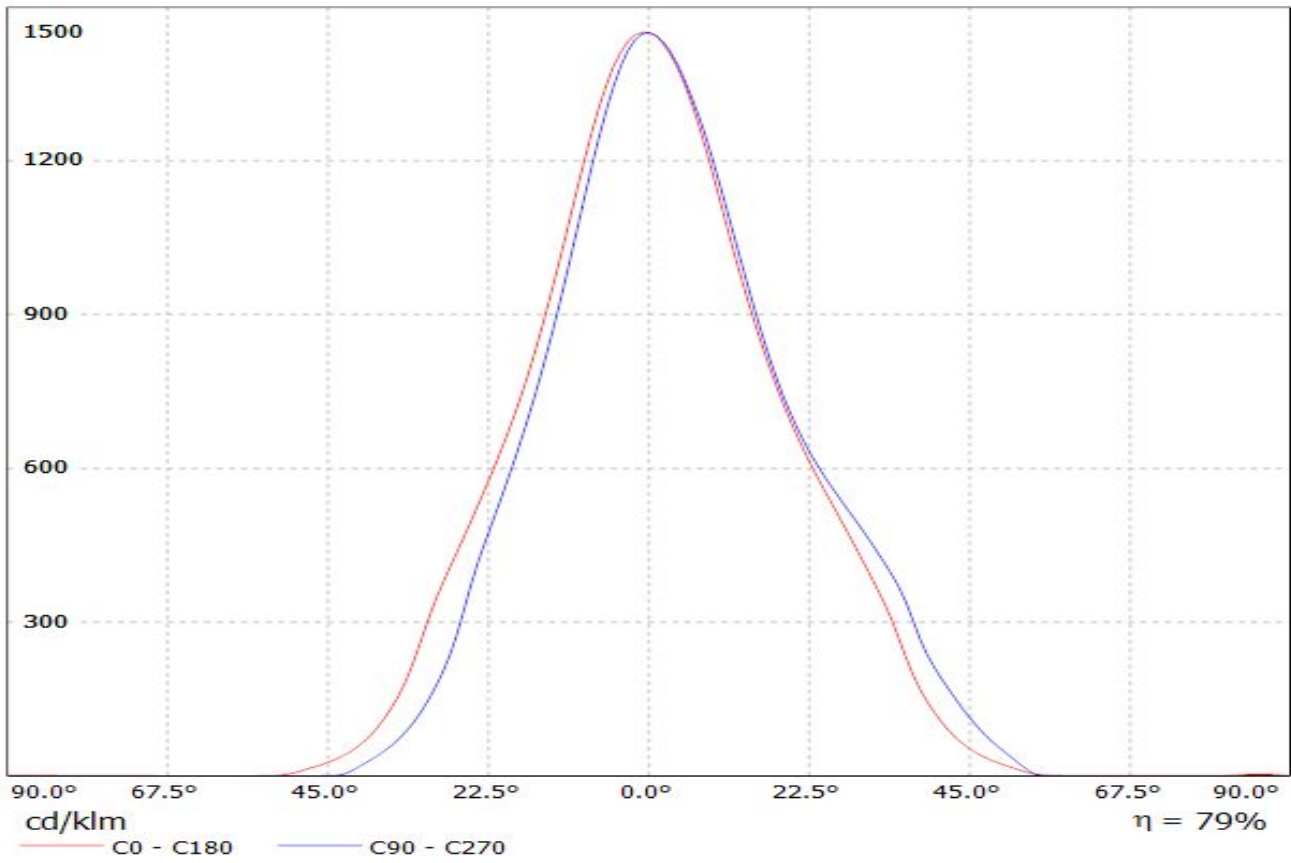

Luminaire: Ledil FC15004\_FLORENTINA-WW\_(LH351B)

Lamps: 1 x Samsung\_LH351B\_x12\_1310.26@250mA\_P=8.4105W\_I=0.25A

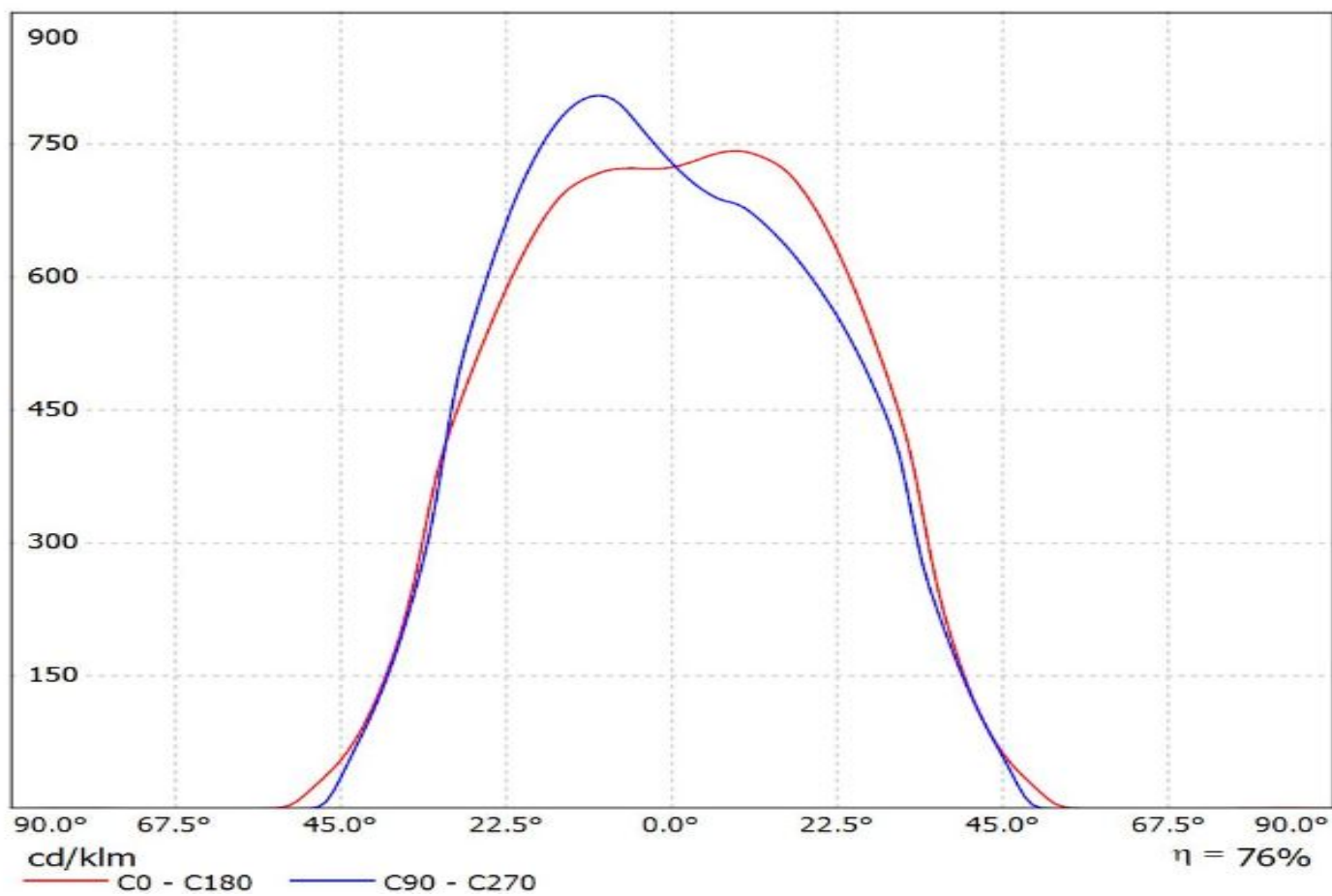

Luminaire: Ledil FC15004\_FLORENTINA-WW\_(TL1L4)  
Lamps: 1 x Toshiba\_TL1L4\_1140.96lm@250mA\_P=8.3597W\_I=0.25A

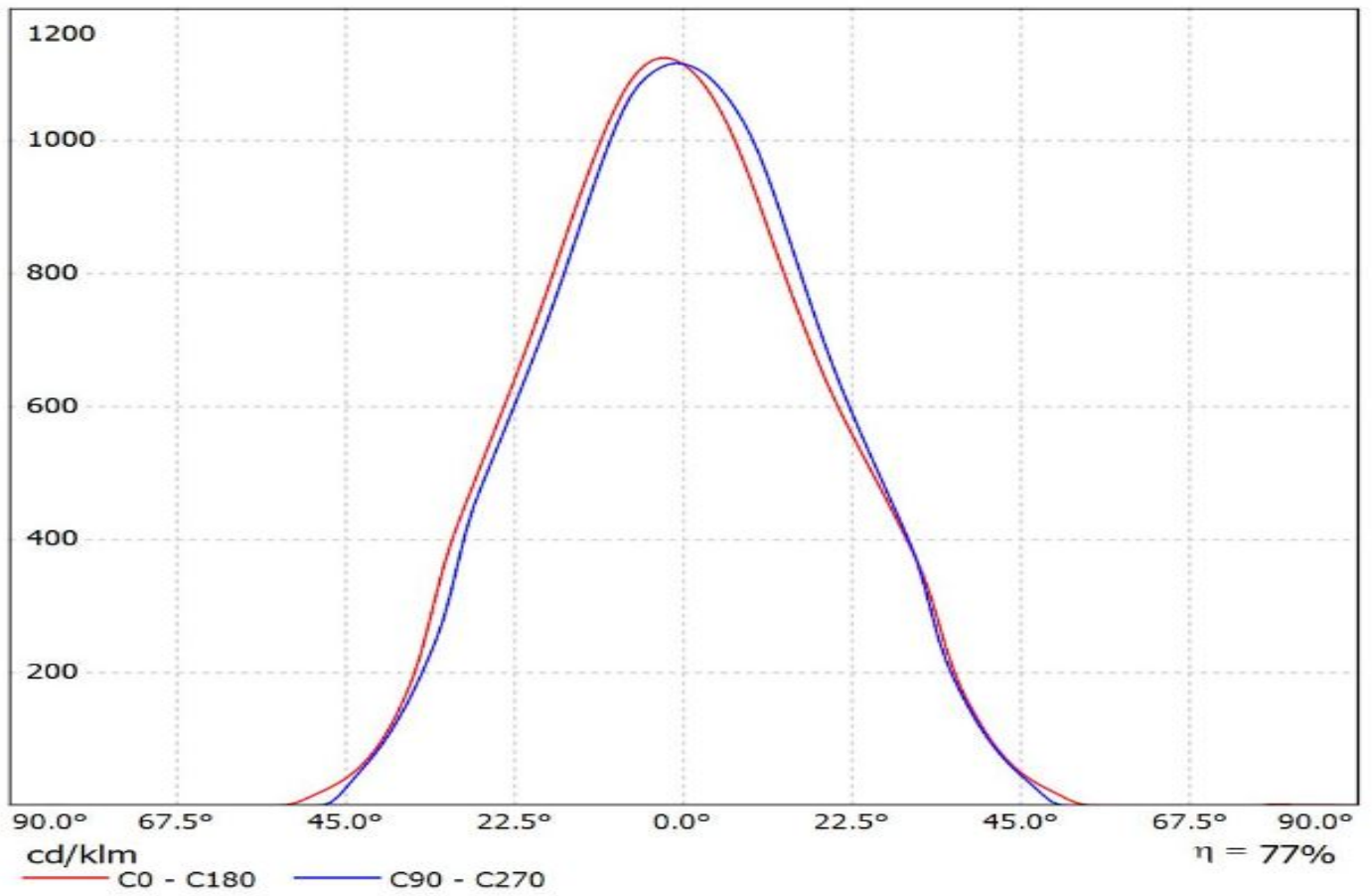



# Ledil FC15004\_FLORENTINA-WW\_(XP-E2) / LDC (Polar)

Luminaire: Ledil FC15004\_FLORENTINA-WW\_(XP-E2)

Lamps: 1 x Cree\_XP-E2\_x12\_(XPEBWT-H1-7A2-Q3-0-03)\_919.369lm@250mA\_P=8.6517W\_l=0.25A

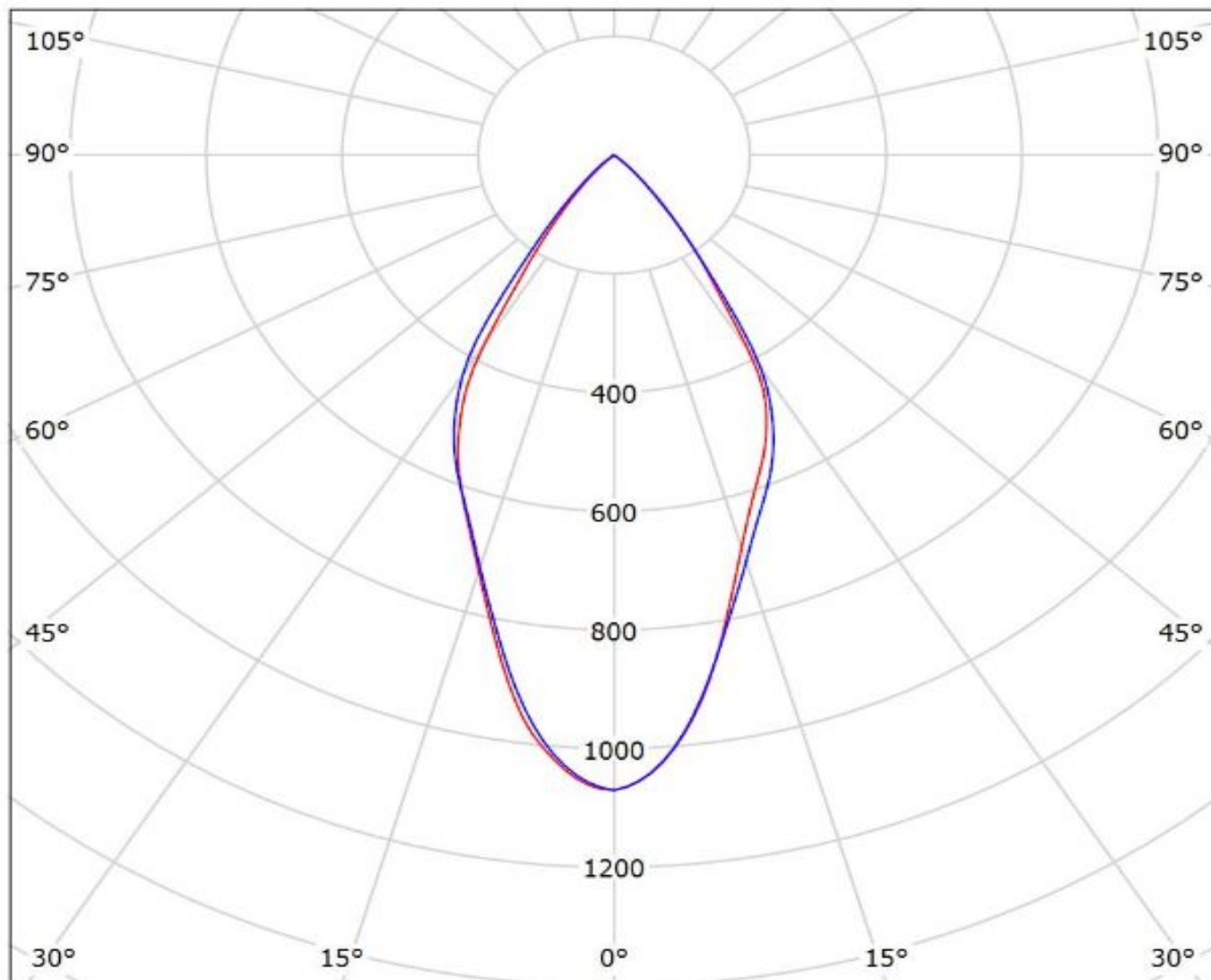

cd/klm

— C0 - C180 — C90 - C270

$\eta = 77\%$

Luminaire: Ledil FC15004\_FLORENTINA-WW\_(XP-G2)

Lamps: 1 x Cree\_XP-G2\_(XPGBWT-01-4A0-R3-0-01)\_1166.49lm@250mA\_P=8.4705W\_I=0.25A

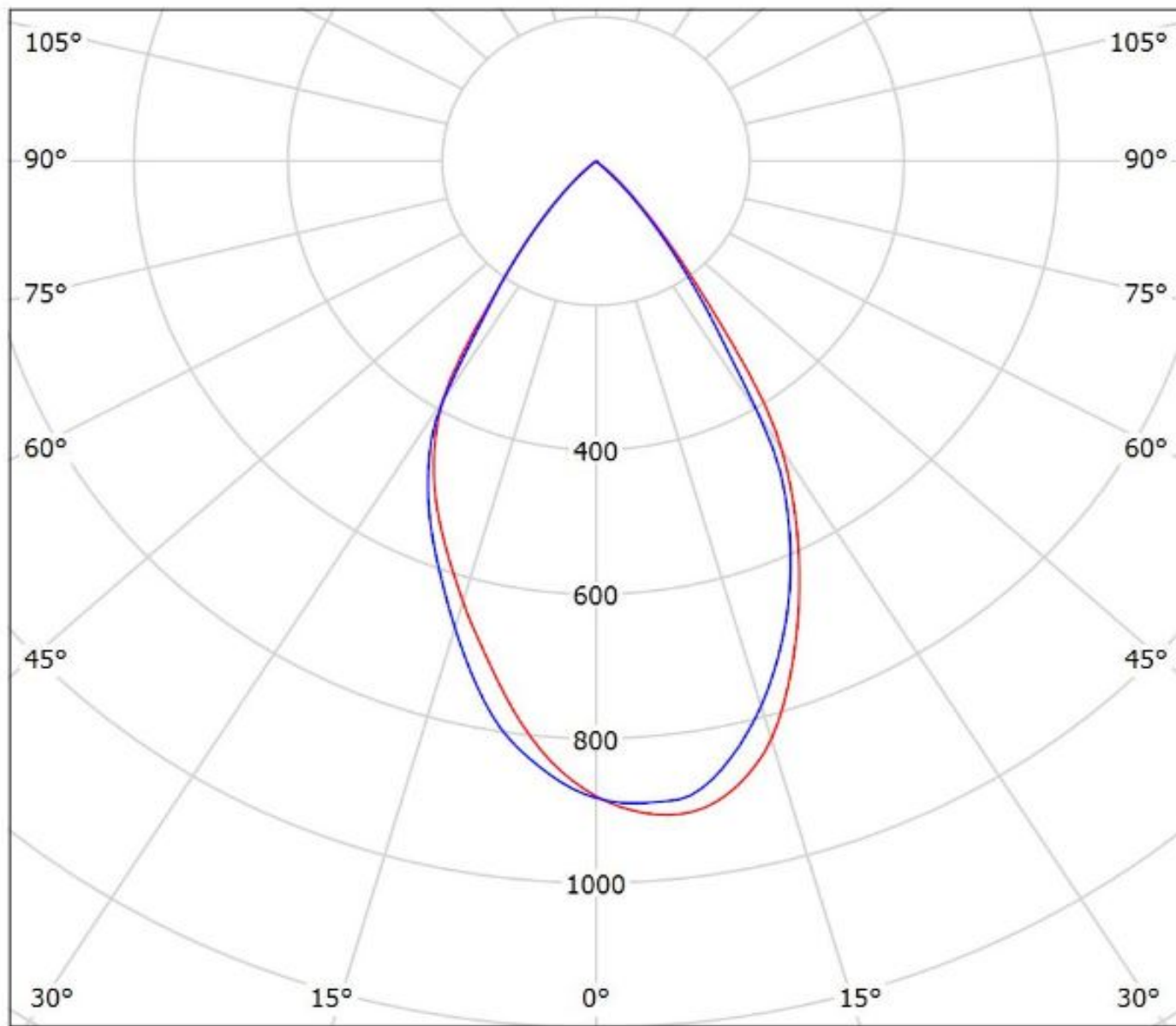

cd/klm

— C0 - C180 — C90 - C270

$\eta = 78\%$

Luminaire: Ledil FC15004\_FLORENTINA-WW\_(LG\_H35C1)  
Lamps: 1 x LG\_H35C1\_x12\_1386.4lm@250mA\_P=8.5608W\_I=0.25A

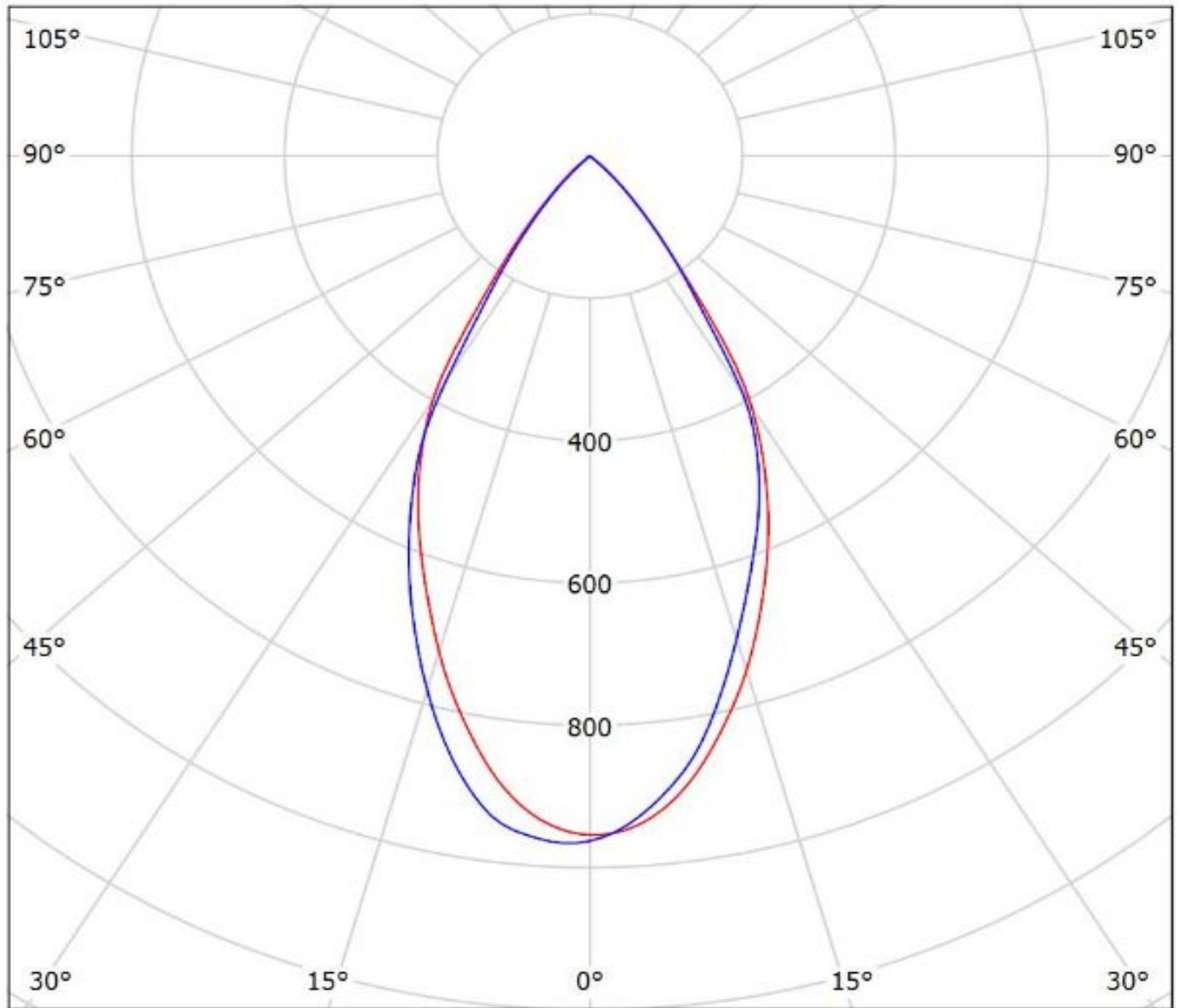

cd/klm  
— C0 - C180 — C90 - C270

η = 77%

# Ledil FC15004\_FLORENTINA-WW\_(Rebel\_Plus) / LDC (Polar)

Luminaire: Ledil FC15004\_FLORENTINA-WW\_(Rebel\_Plus)

Lamps: 1 x Luxeon\_Rebel\_Plus\_x12\_(LX18-P140-3)

\_1023.73lm@250mA\_CCT=4000K\_P=8.4525W\_I=0.25A

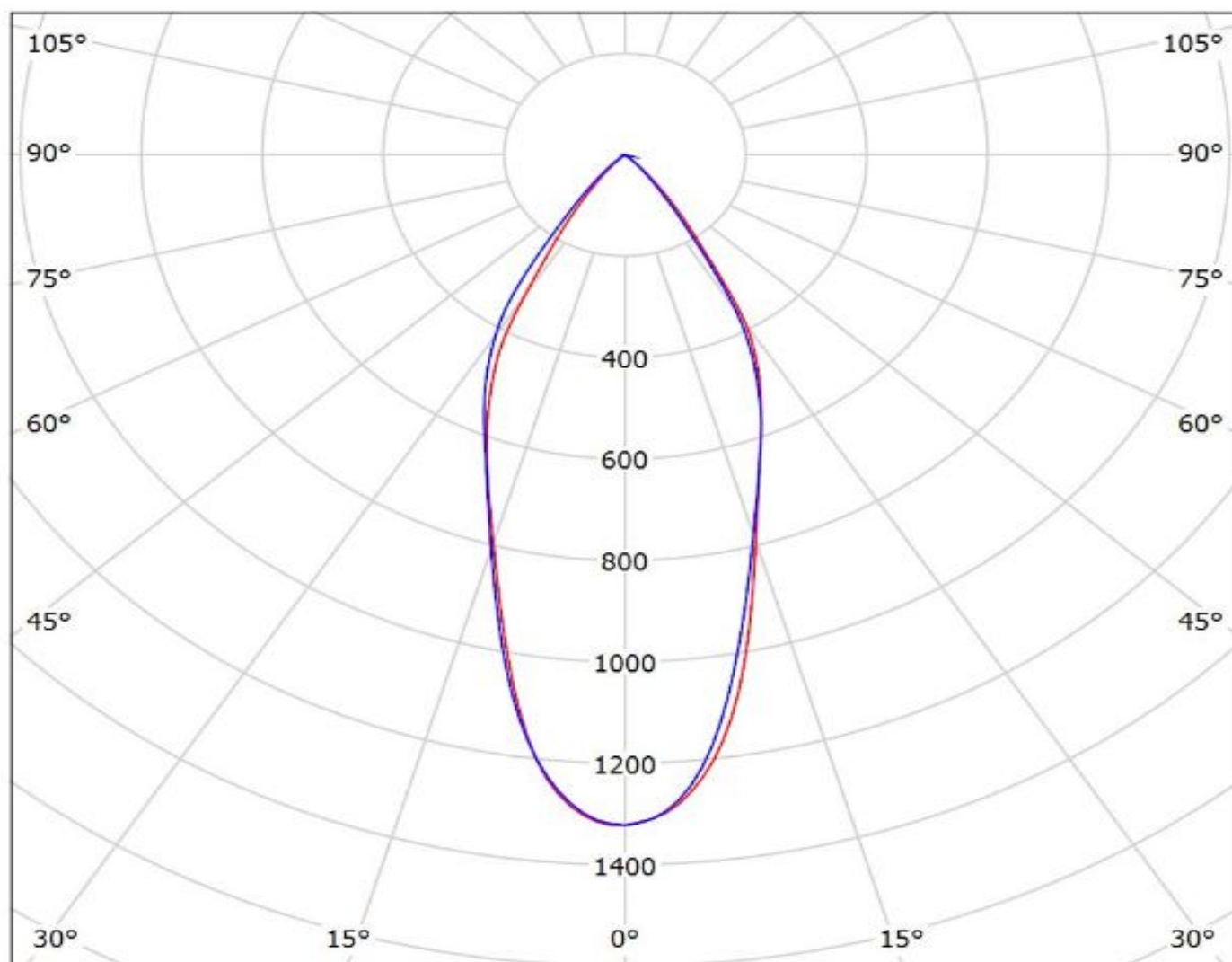

cd/klm

— C0 - C180

— C90 - C270

$\eta = 79\%$

# Ledil FC15004\_FLORENTINA-WW\_(Luxeon\_TX) / LDC (Polar)

Luminaire: Ledil FC15004\_FLORENTINA-WW\_(Luxeon\_TX)

Lamps: 1 x Luxeon\_TX\_x12\_(L1T2-5770)\_1350.11lm@250mA\_CCT=5700K\_P=8.3223W\_I=0.25A

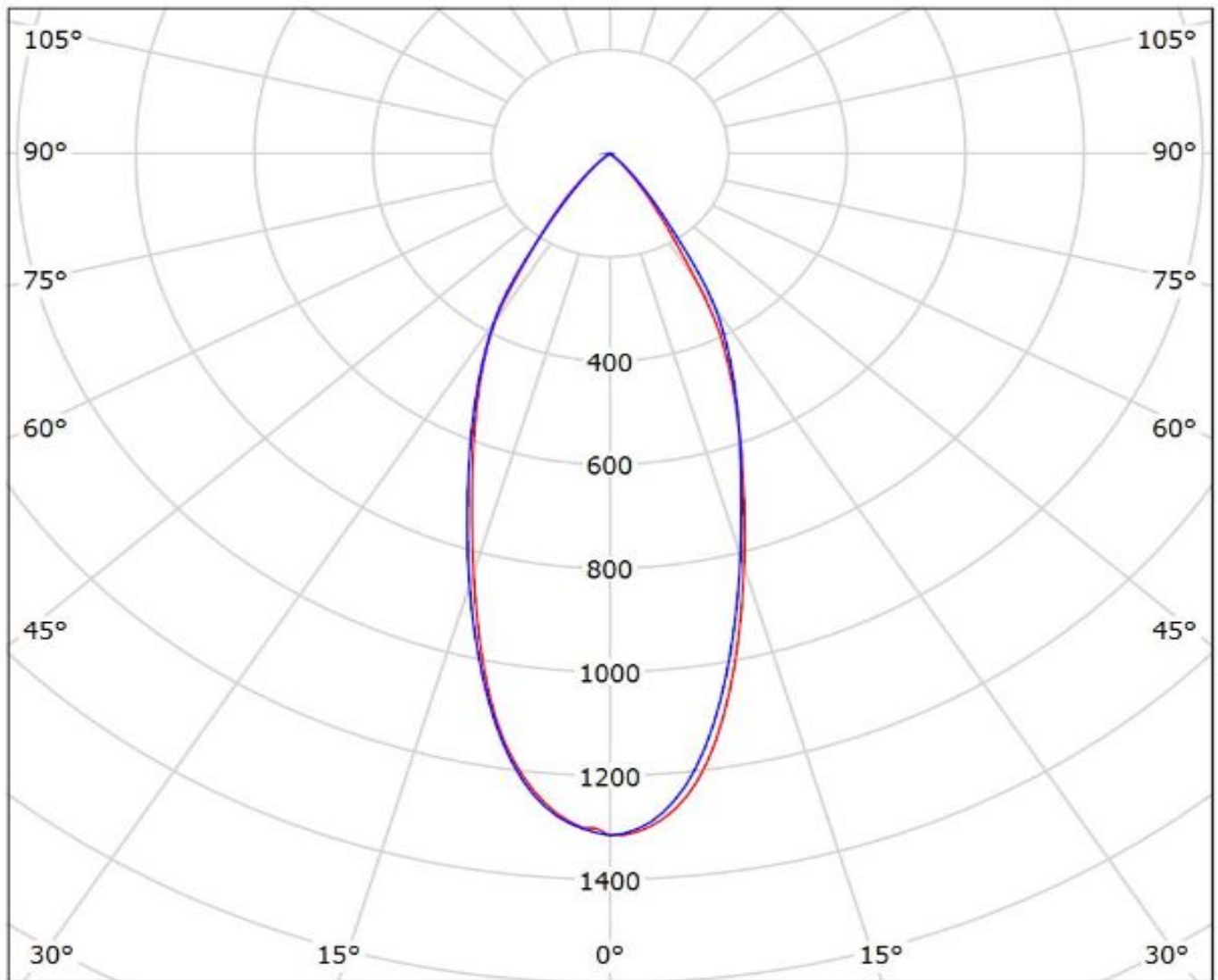

cd/klm

— C0 - C180 — C90 - C270

$\eta = 78\%$

# Ledil FC15004\_FLORENTINA-WW\_(Rebel\_ES) / LDC (Polar)

Luminaire: Ledil FC15004\_FLORENTINA-WW\_(Rebel\_ES)

Lamps: 1 x Luxeon\_Rebel\_ES\_x12\_(LXML-PWC2)\_1133.87lm@250mA\_P=8.6613W\_I=0.25A

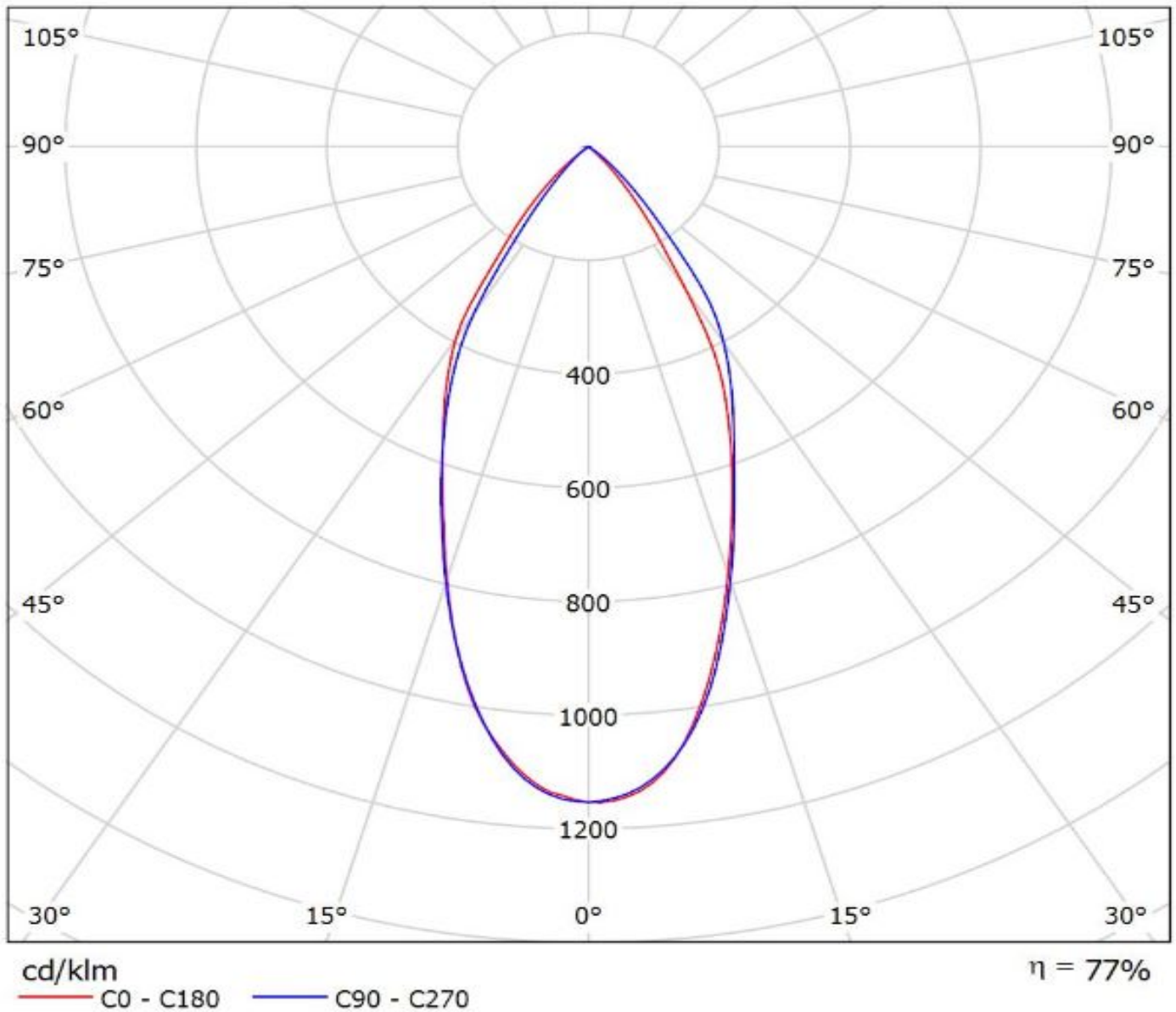

Luminaire: Ledil FC15004\_FLORENTINA-WW\_(Luxeon\_Z-ES)  
Lamps: 1 x Luxeon\_Z-ES\_x12\_934.806@250mA\_P=8.3W\_I=0.25A

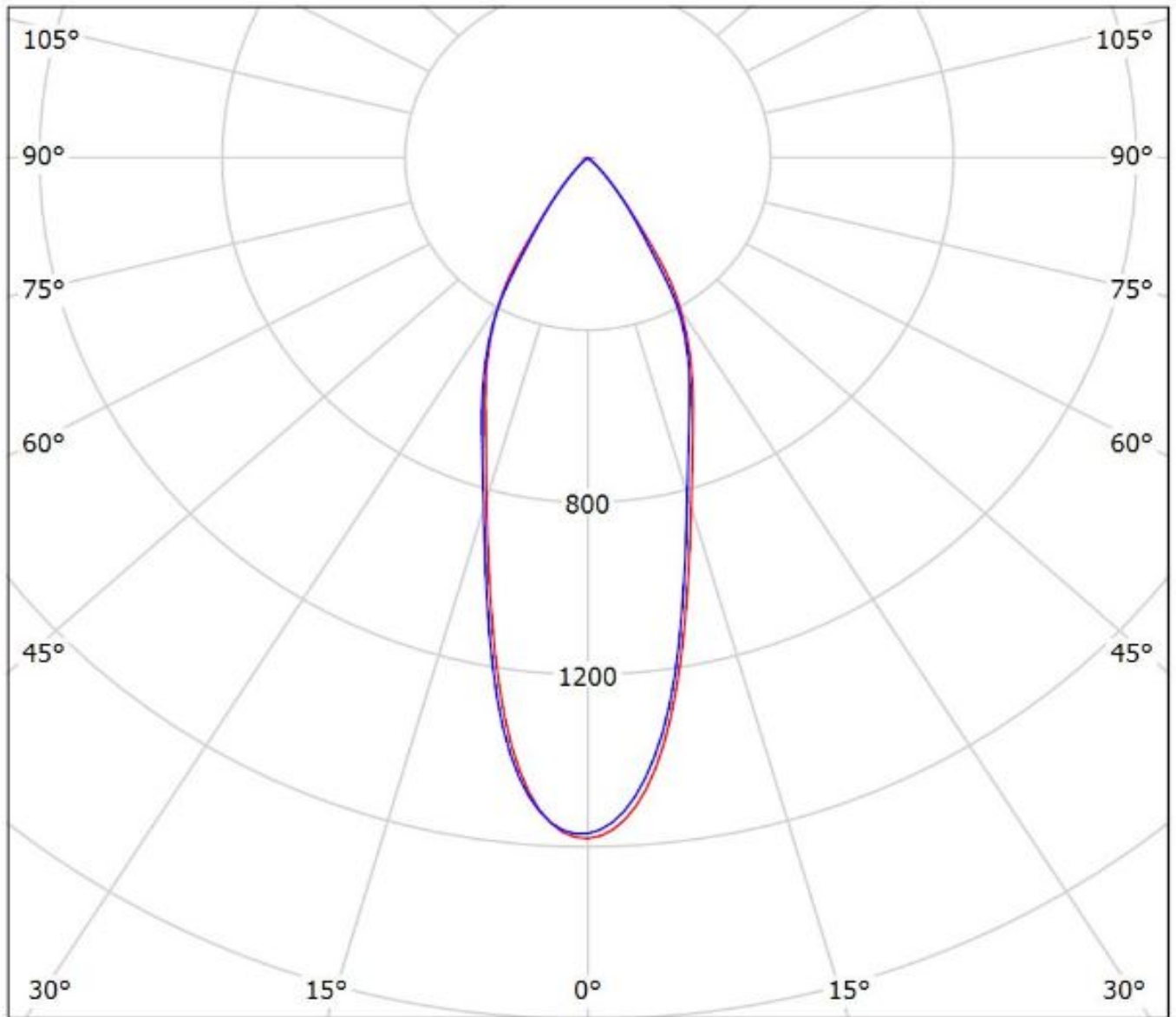

cd/klm  
— C0 - C180 — C90 - C270

$\eta = 80\%$

# Ledil FC15004\_FLORENTINA-WW\_(NCSxx19B) / LDC (Polar)

Luminaire: Ledil FC15004\_FLORENTINA-WW\_(NCSxx19B)

Lamps: 1 x Nichia\_NCSxx19B\_x12\_(NCSL219B)\_936.422lm@250mA\_P=8.9525W\_I=0.25A

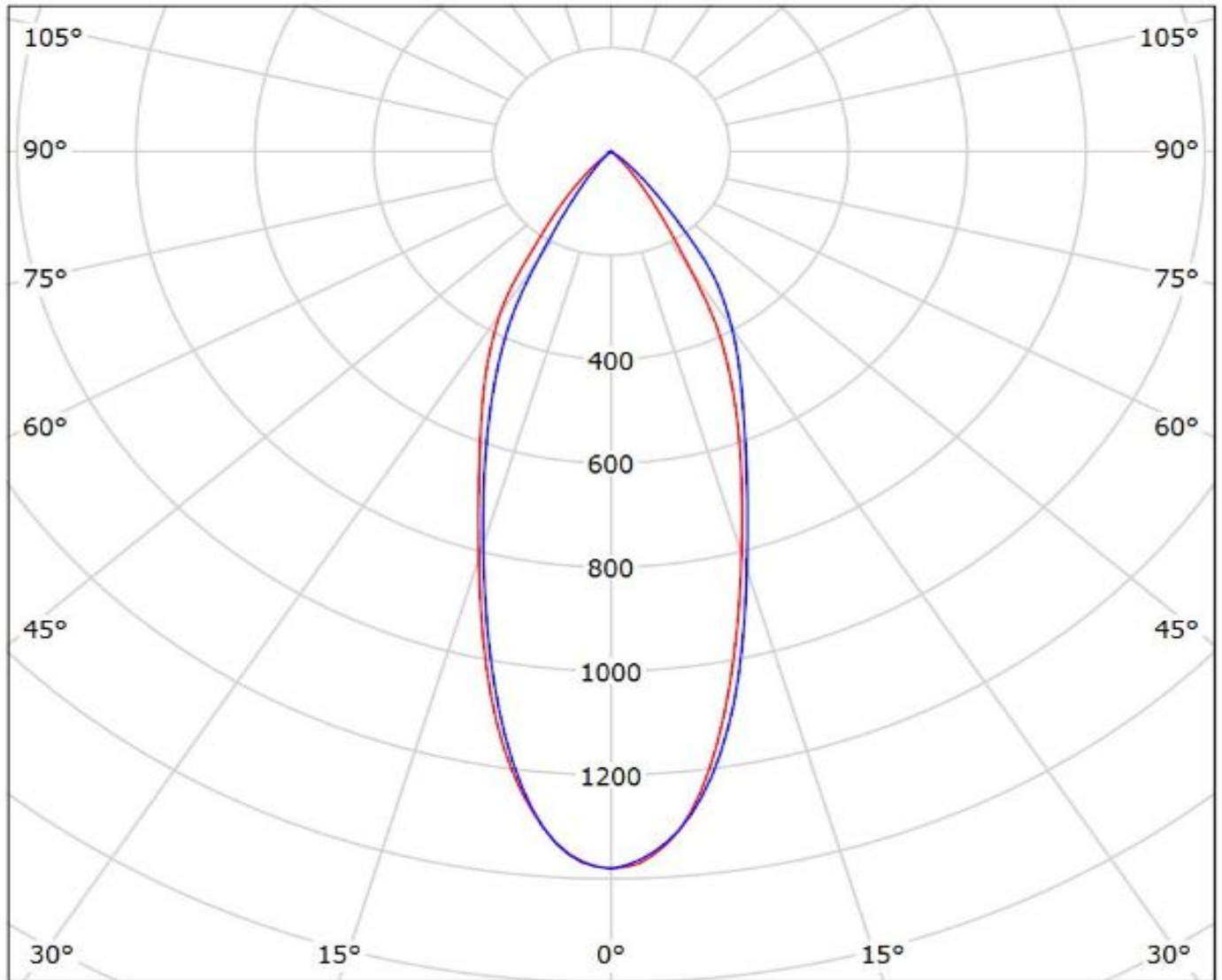

cd/klm

— C0 - C180 — C90 - C270

$\eta = 76\%$



Luminaire: Ledil FC15004\_FLORENTINA-WW\_(NVSL219B)

Lamps: 1 x Nichia\_NVSL219B\_x12\_1040.35@250mA\_P=8.6165W\_I=0.25A

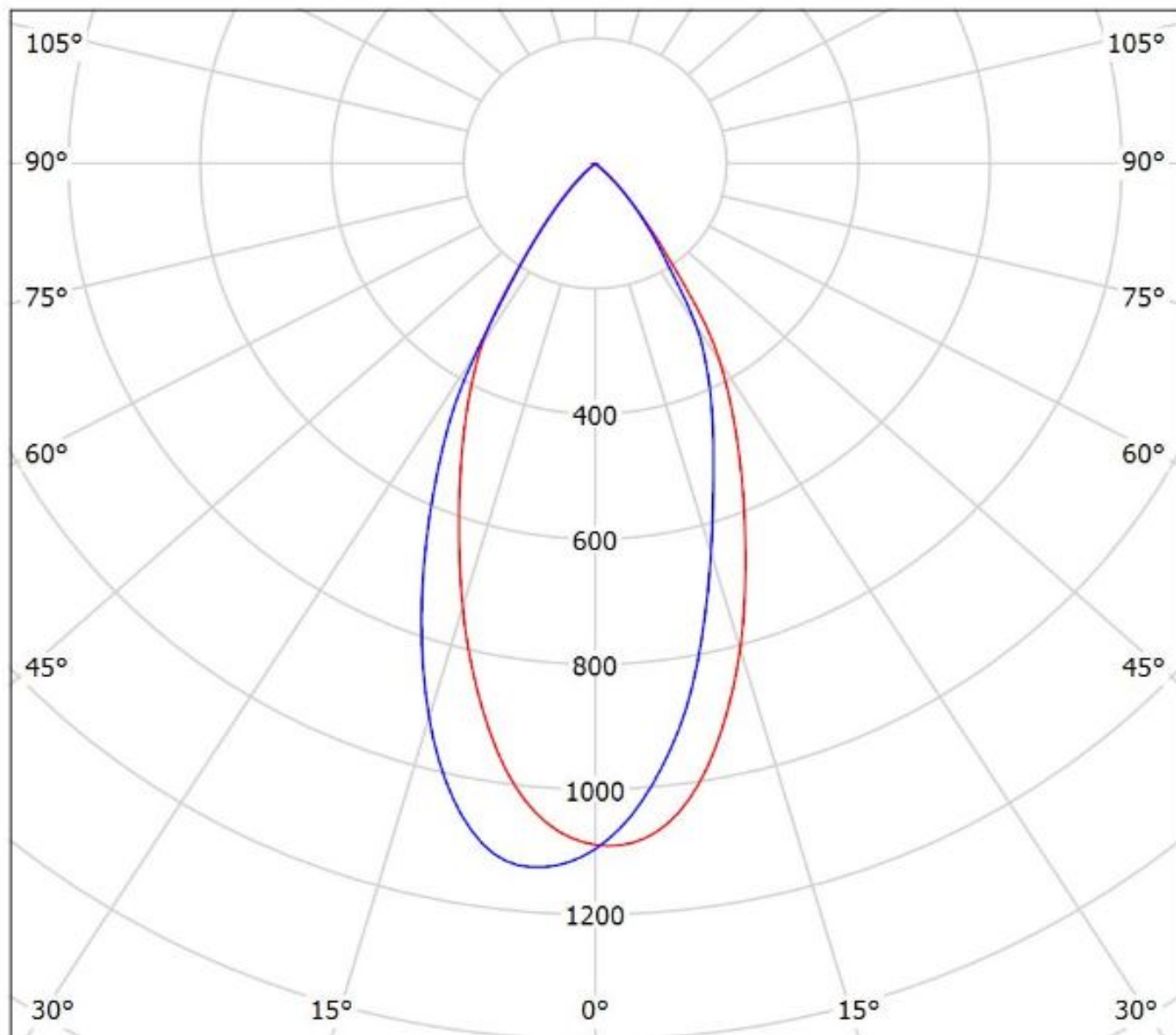

cd/klm

— C0 - C180 — C90 - C270

$\eta = 74\%$

## Ledil FC15004\_FLORENTINA-WW\_(SSL80) / LDC (Polar)

Luminaire: Ledil FC15004\_FLORENTINA-WW\_(SSL80)

Lamps: 1 x Oslon\_SSL80\_x12\_(LCW\_CQ7P.ĚC)\_826.663lm@250mA\_P=9.3033W\_I=0.25A

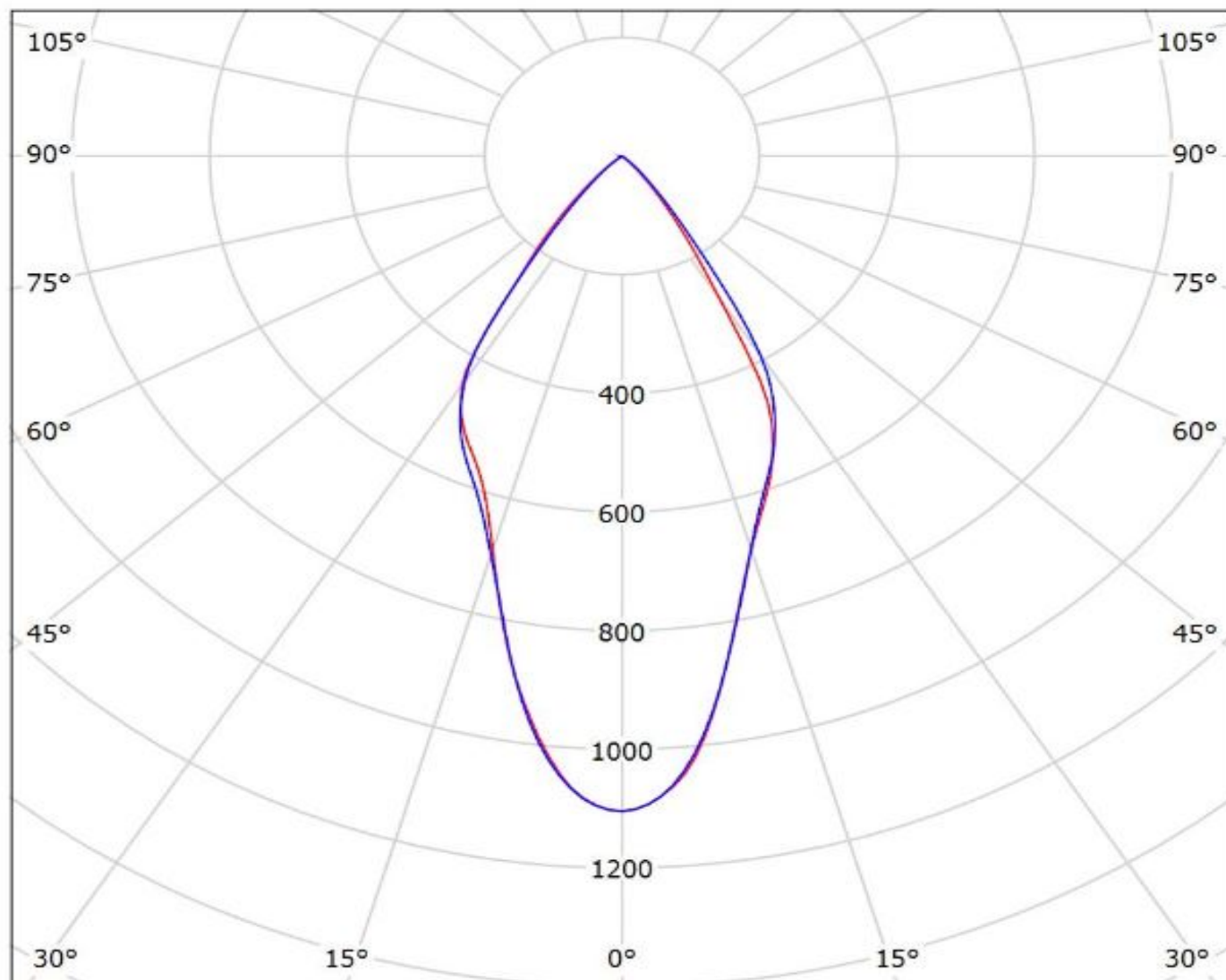

cd/klm

— C0 - C180 — C90 - C270

$\eta = 75\%$

Luminaire: Ledil FC15004\_FLORENTINA-WW\_(SQ-EC)

Lamps: 1 x OSLOM\_SQUARE-EC\_x12\_1046.45lm@250mA\_P=8.3193W\_I=0.25A

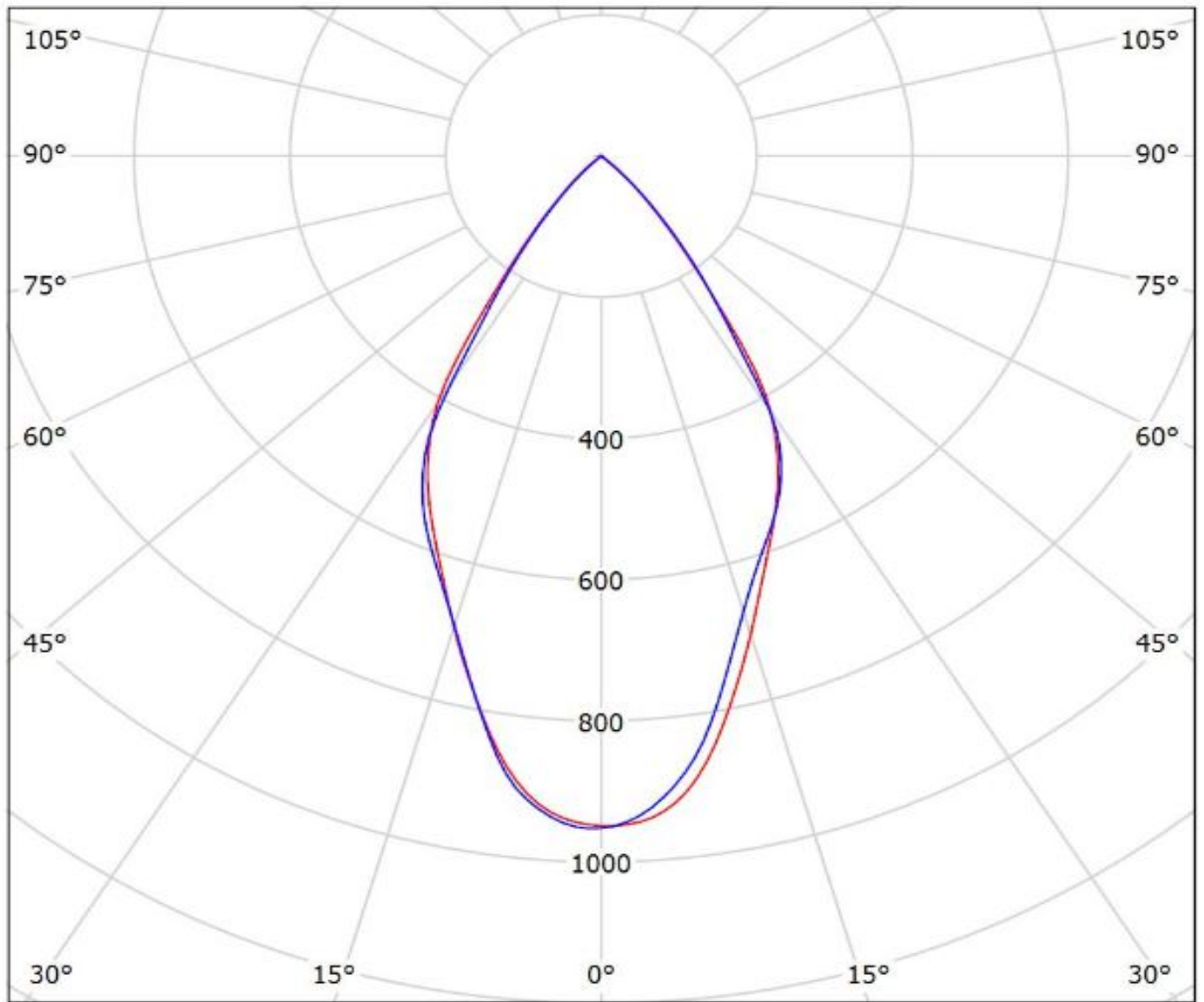

cd/klm

— C0 - C180

— C90 - C270

$\eta = 76\%$

Luminaire: Ledil FC15004-FLORENTINA-WW\_(SSL150)  
Lamps: 1 x Oslon\_SSL150\_995.439lm@250mA\_P=8.4375W\_I=0.25A

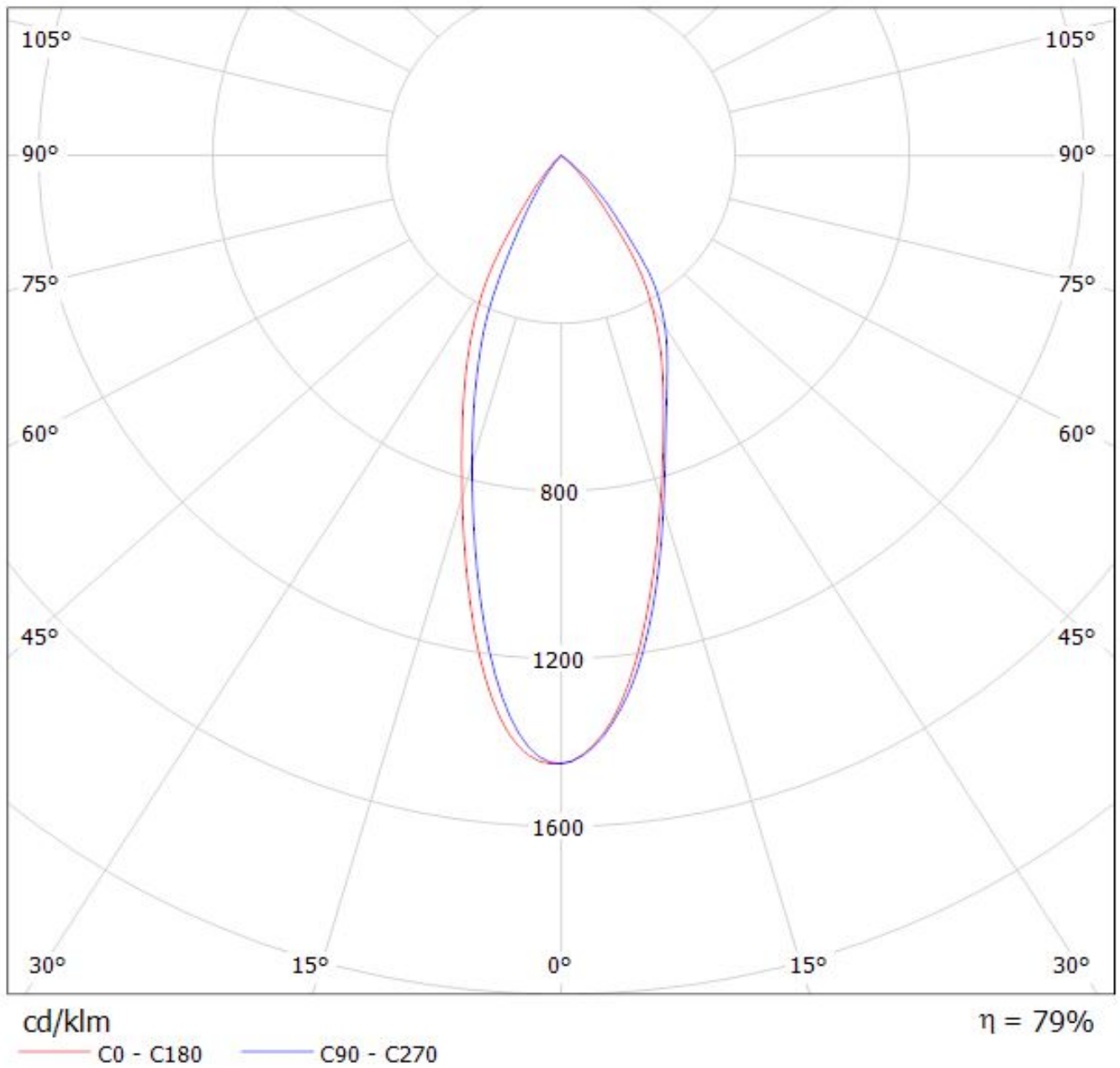

Luminaire: Ledil FC15004\_FLORENTINA-WW\_(LH351B)

Lamps: 1 x Samsung\_LH351B\_x12\_1310.26@250mA\_P=8.4105W\_I=0.25A

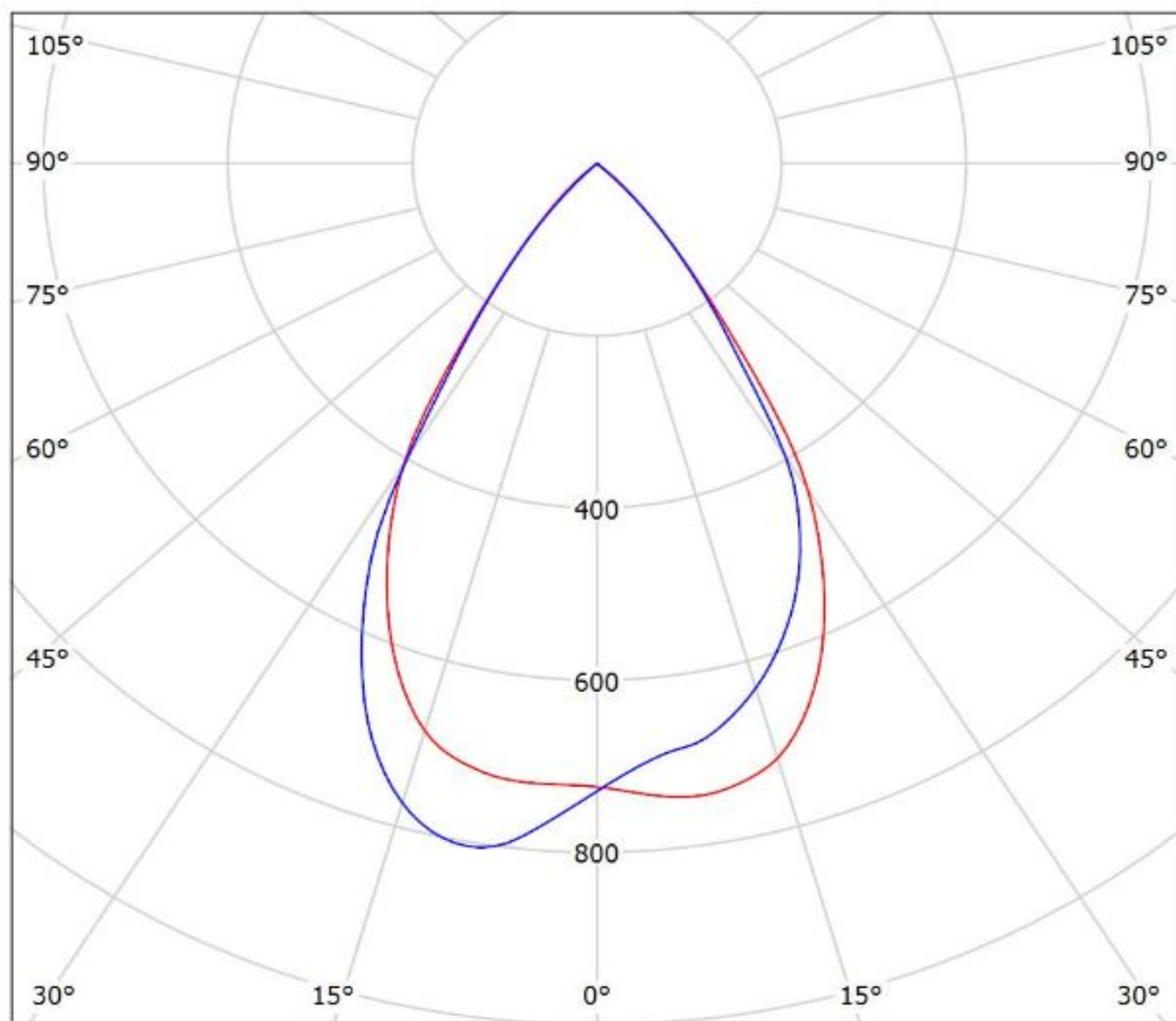

cd/klm

— C0 - C180 — C90 - C270

$\eta = 76\%$

Luminaire: Ledil FC15004\_FLORENTINA-WW\_(TL1L4)  
Lamps: 1 x Toshiba\_TL1L4\_1140.96lm@250mA\_P=8.3597W\_I=0.25A

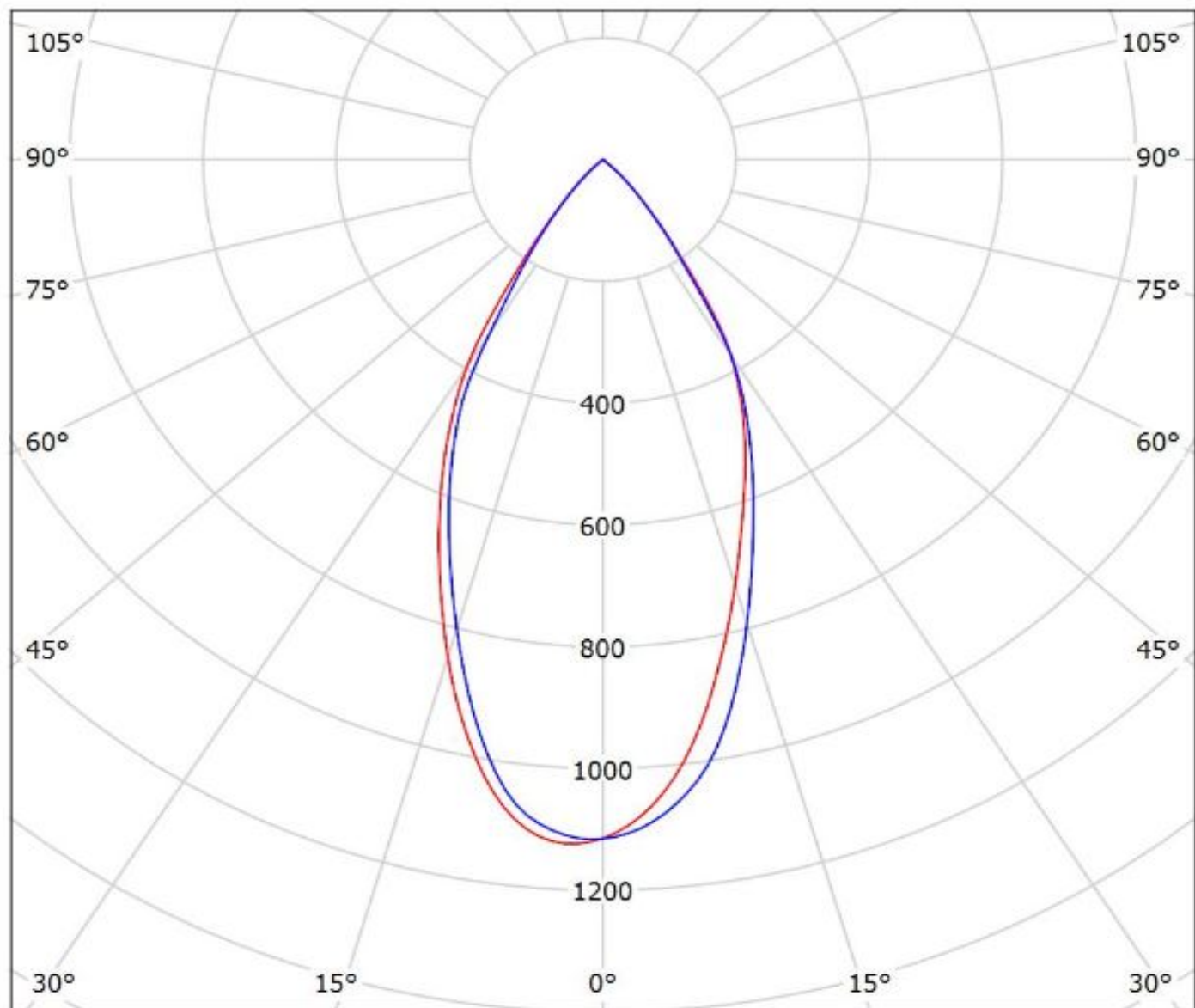

cd/klm  
— C0 - C180 — C90 - C270

$\eta = 77\%$

**NOTE: The typical divergence will be changed by different color, chip size and chip position tolerance. The typical total divergence is the full angle measured where the luminous intensity is half of the peak value.**