

SPECIFICATION

- Part No. : **PCS.06.A Havok**
- Product Name : Havok - Low Profile LTE/Cellular 4G/3G/2G SMD Dielectric Antenna
- Features : SMD Dielectric Antenna
GSM / CDMA / DCS / PCS / WCDMA /
UMTS /HSDPA / GPRS / EDGE
698~960MHz/1710~2690MHz High Efficiency Multi-Band
SMD antenna
Low profile 42*10*3mm
RoHs Compliant

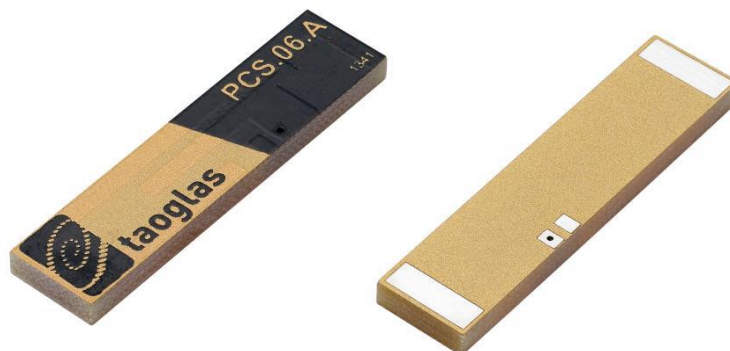

1. Introduction

The Havok PCS.06.A is a low profile SMT LTE/cellular 4G/3G/2G embedded antenna designed for direct SMT mount on a device PCB. It provides high efficiency in a very small factor 42*10*3mm. If tuning is required it can be tuned for the device environment, while there is no need for new tooling. Its rectangular shape and very small size makes it very easy to integrate – packaged in tape and reel, it can be mounted via pick and place to reflow solder directly on the edge of the PCB board. This antenna is recommended to be used with longer ground-plane lengths of 120mm or more to attain its highest rated efficiency, note the return loss and efficiency graphs on page 22.

The antenna is suitable for lower cost LTE/cellular applications, especially for telematics and automotive sector. Contact Taoglas local regional sales office for quick and professional support from our senior engineering team on integration and matching of the antenna to your device.

2. Specification Table

ELECTRICAL							
Frequency (MHz)	698~803	824~894	880~960	1710~1880	1850~1990	1920~2170	2500~2690
Peak Gain (dBi)*	-0.21	0.77	0.61	3.05	2.92	3.17	3.72
Average Gain (dBi)*	-2.52	-1.91	-2.16	-1.87	-1.85	-1.79	-2.30
Efficiency (%)*	45%	64.38	60.99	65.02	65.36	66.19	58.99
Return Loss (dB)*	<-10 typ. <-7 at the band edge		<-10 typ. <-7 at the band edge			<-10 typ. <-6 at the band edge	
Polarization	Linear						
Impedance	50Ω						
Maximum Input Power	5W						
MECHANICAL							
Antenna Dimensions	42mm x 10mm x 3mm						
Material	FR4						
Weight	2.50g						
Soldering Type	SMT through Reflow						
ENVIRONMENTAL							
Operation Temperature	-40°C ~ +85°C						
Storage Temperature	-40°C ~ +85°C						

* all measurements were done on 123*45mm EVB board with 100mm length ground plane.

LTE BANDS			
Band Number	LTE / LTE-Advanced / WCDMA / HSPA / HSPA+ / TD-SCDMA		
	Uplink	Downlink	Covered
1	UL: 1920 to 1980	DL: 2110 to 2170	✓
2	UL: 1850 to 1910	DL: 1930 to 1990	✓
3	UL: 1710 to 1785	DL: 1805 to 1880	✓
4	UL: 1710 to 1755	DL: 2110 to 2155	✓
5	UL: 824 to 849	DL: 869 to 894	✓
7	UL: 2500 to 2570	DL: 2620 to 2690	✓
8	UL: 880 to 915	DL: 925 to 960	✓
9	UL: 1749.9 to 1784.9	DL: 1844.9 to 1879.9	✓
11	UL: 1427.9 to 1447.9	DL: 1475.9 to 1495.9	✗
12	UL: 699 to 716	DL: 729 to 746	✓
13	UL: 777 to 787	DL: 746 to 756	✓
14	UL: 788 to 798	DL: 758 to 768	✓
17	UL: 704 to 716	DL: 734 to 746 (LTE only)	✓
18	UL: 815 to 830	DL: 860 to 875 (LET only)	✓
19	UL: 830 to 845	DL: 875 to 890	✓
20	UL: 832 to 862	DL: 791 to 821	✓
21	UL: 1447.9 to 1462.9	DL: 1495.9 to 1510.9	✗
22	UL: 3410 to 3490	DL: 3510 to 3590	✗
23	UL: 2000 to 2020	DL: 2180 to 2200 (LTE only)	✓
24	UL: 1625.5 to 1660.5	DL: 1525 to 1559 (LTE only)	✓
25	UL: 1850 to 1915	DL: 1930 to 1995	✓
26	UL: 814 to 849	DL: 859 to 894	✓
27	UL: 807 to 824	DL: 852 to 869 (LTE only)	✓
28	UL: 703 to 748	DL: 758 to 803 (LTE only)	✓
29	UL: -	DL: 717 to 728 (LTE only)	✓
30	UL: 2305 to 2315	DL: 2350 to 2360 (LTE only)	✓
31	UL: 452.5 to 457.5	DL: 462.5 to 467.5 (LTE only)	✗
32	UL: -	DL: 1452 - 1496	✗
35		1850 to 1910	✓
38		2570 to 2620	✓
39		1880 to 1920	✓
40		2300 to 2400	✓
41		2496 to 2690	✓
42		3400 to 3600	✗
43		3600 to 3800	✗

*Covered bands represent an efficiency greater than 20%

3. Antenna Characteristics

3.1. Return Loss

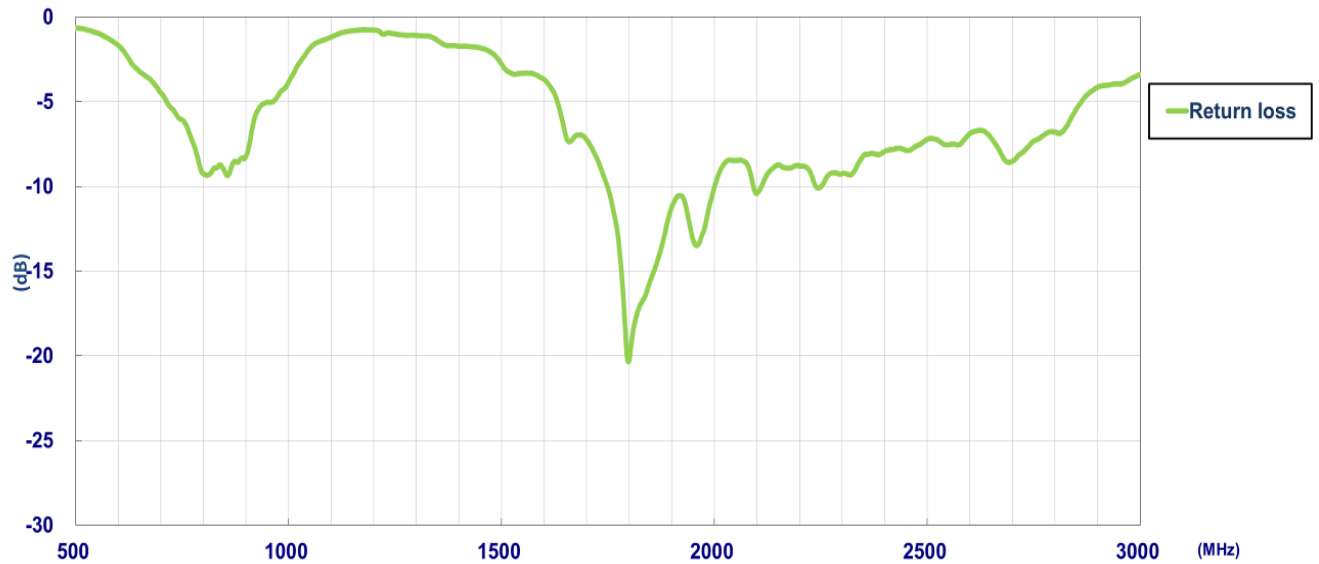

3.2. Efficiency

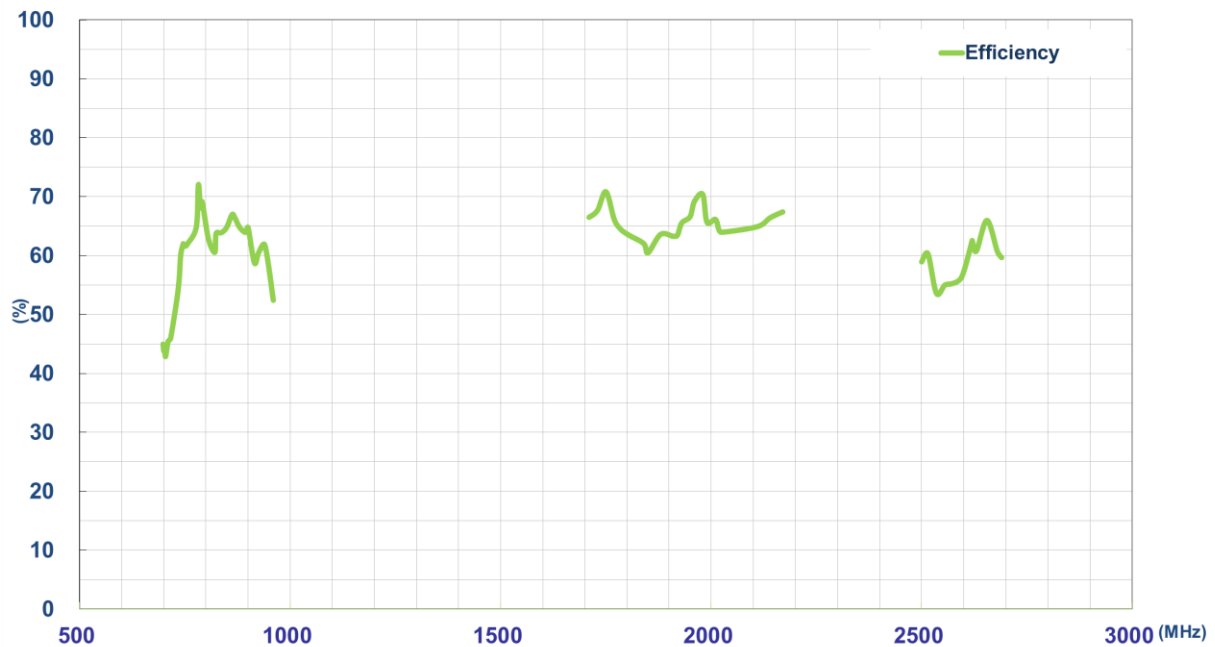

3.3. Peak Gain

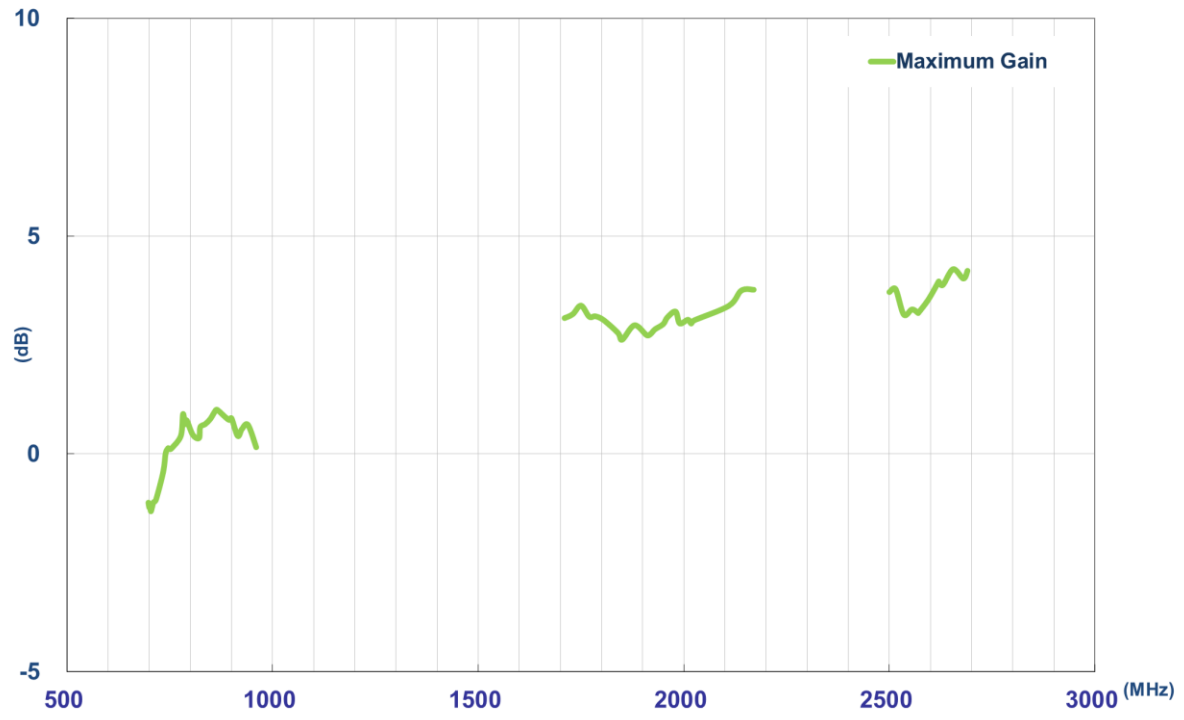

3.4. Average Gain

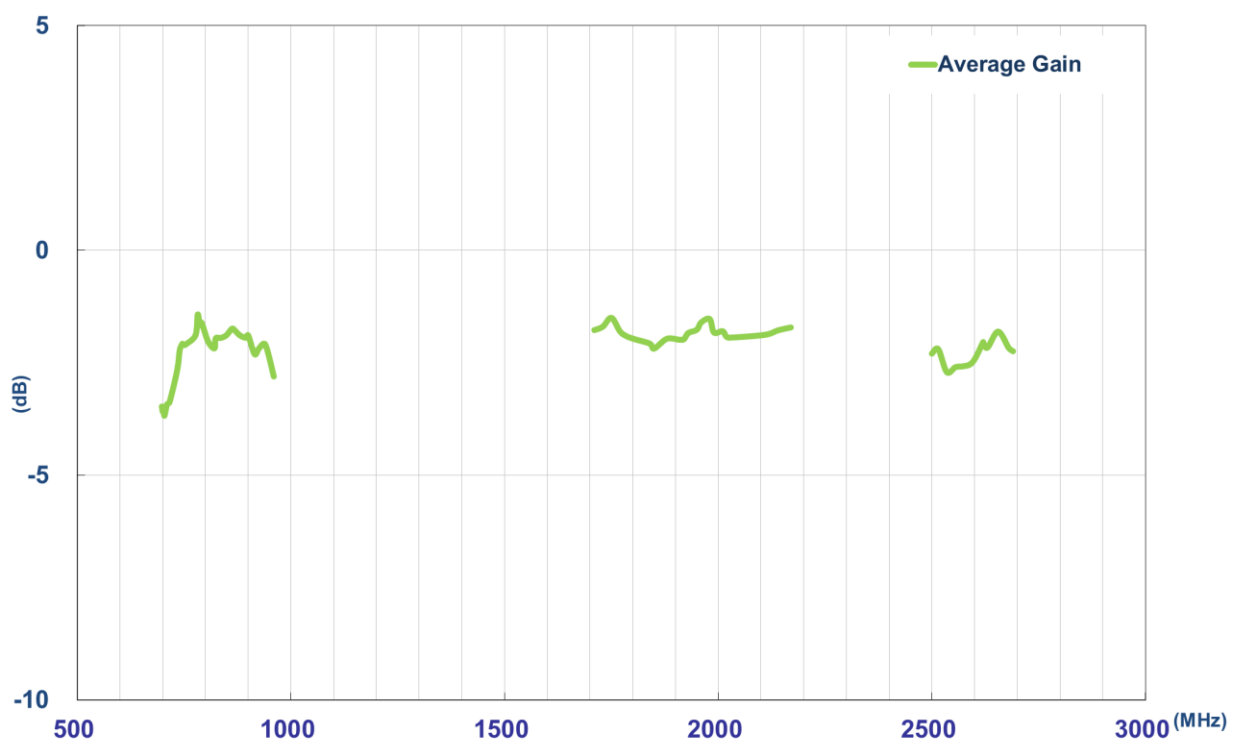

4. Radiation Patterns

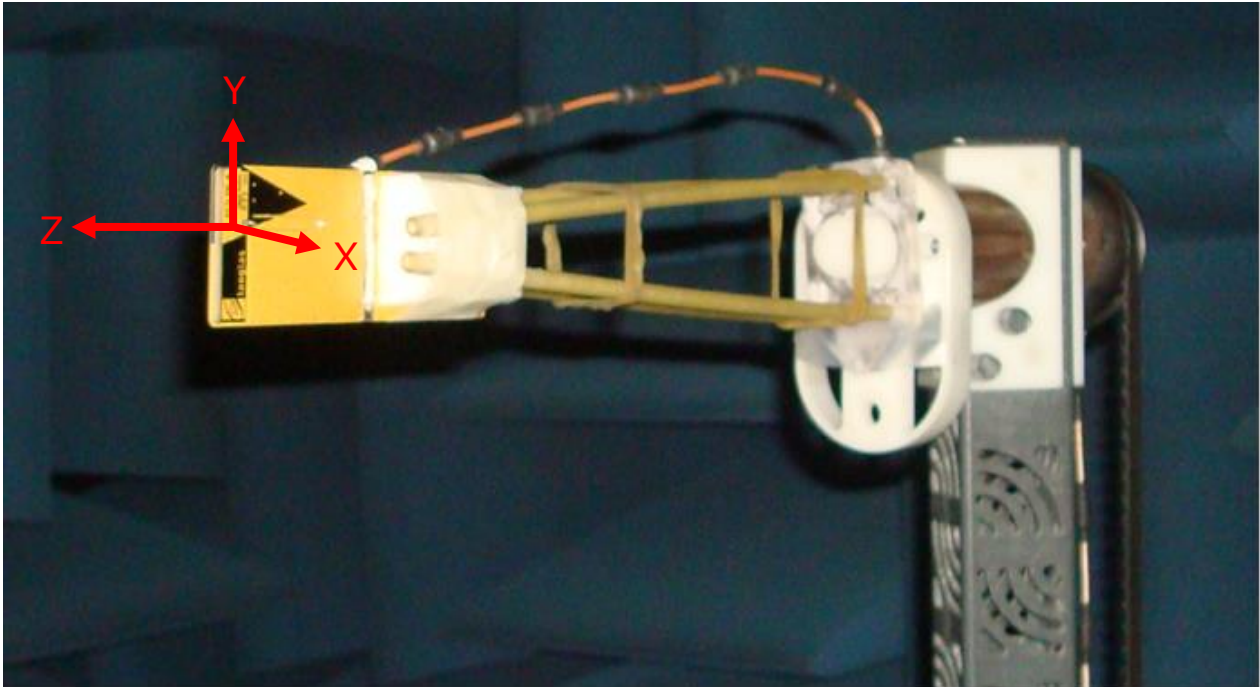

4.1. XY Plane

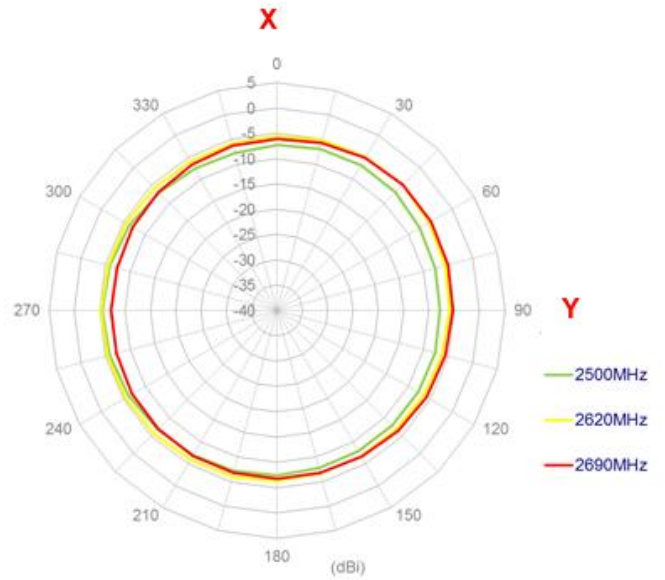
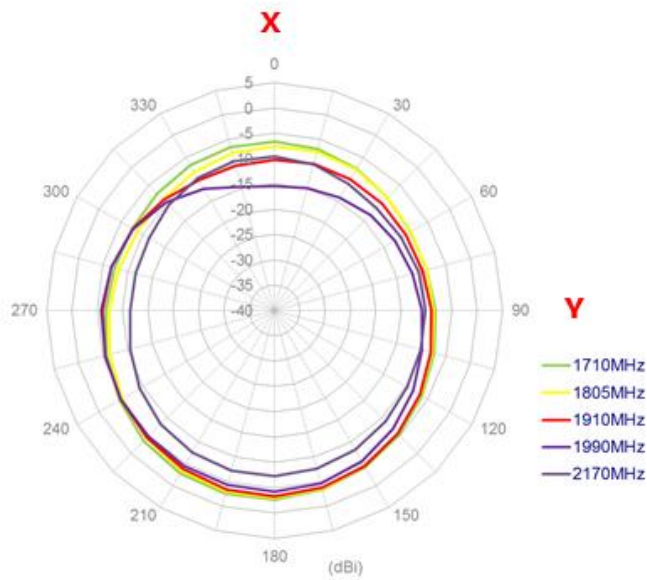
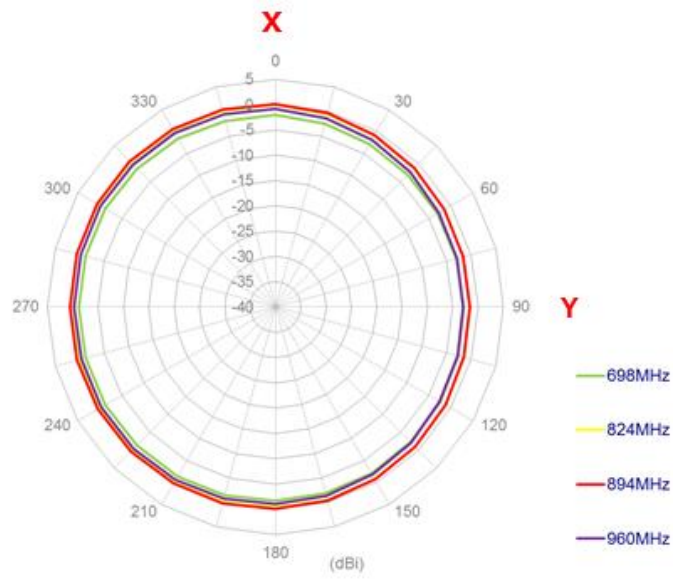

4.2. XZ Plane

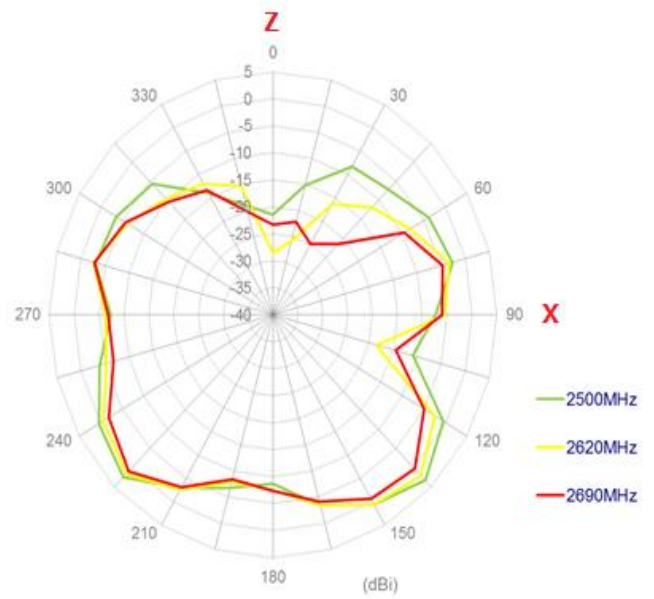
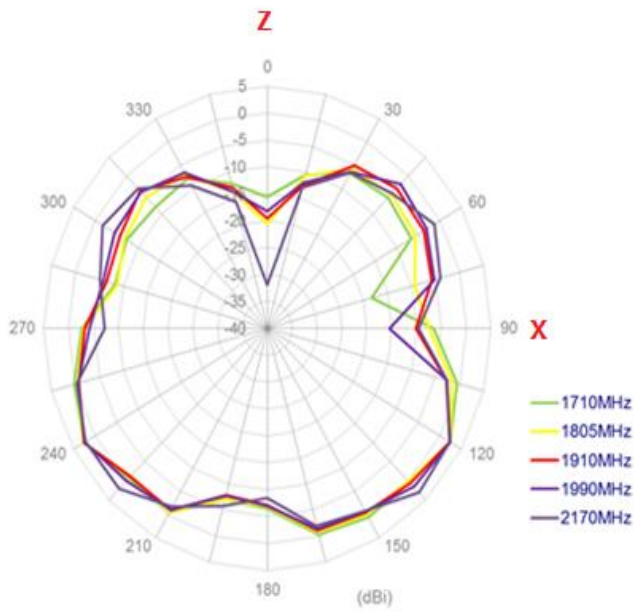
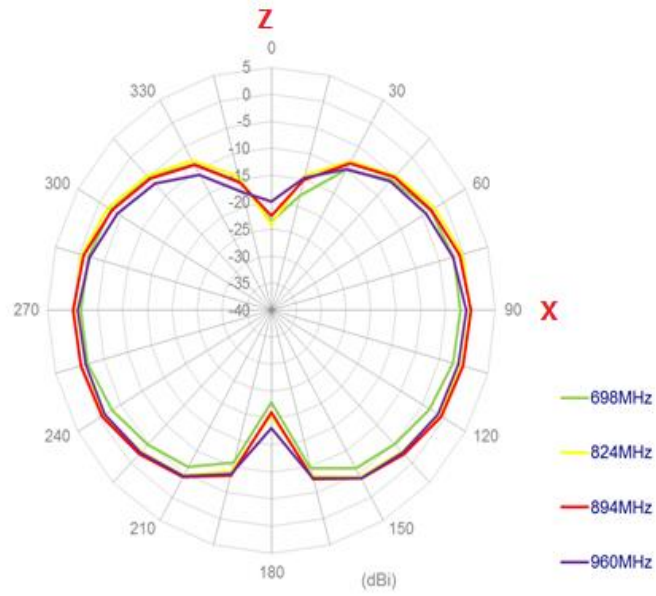

4.3. YZ Plane

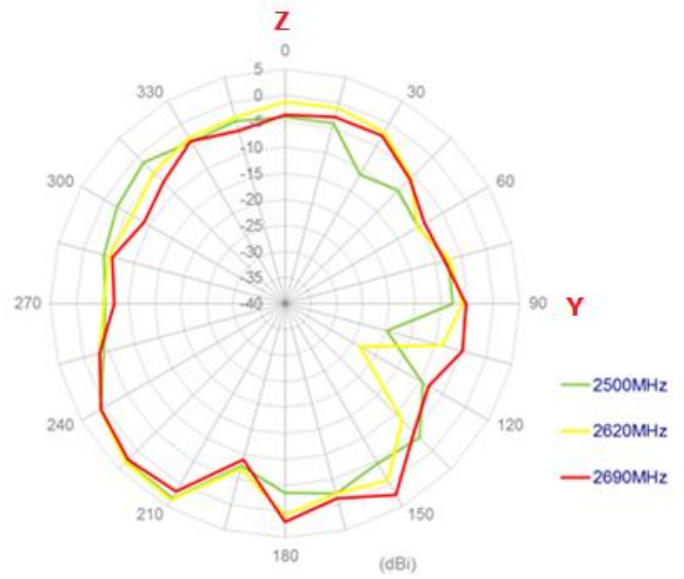
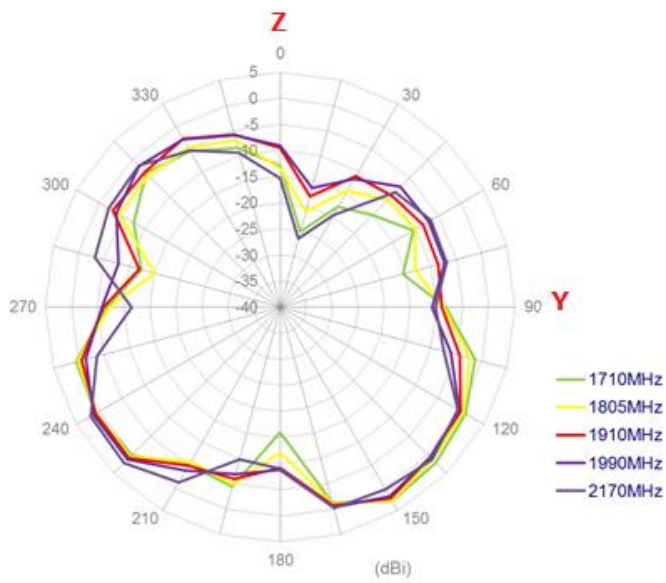
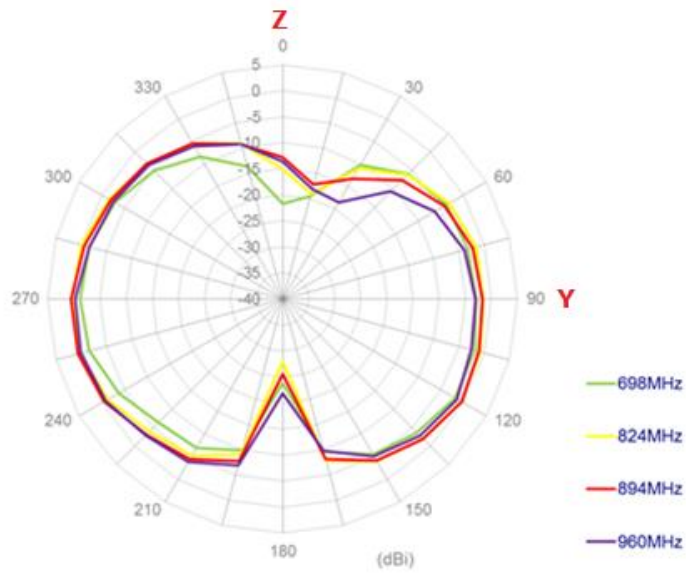

5. Matching Circuits

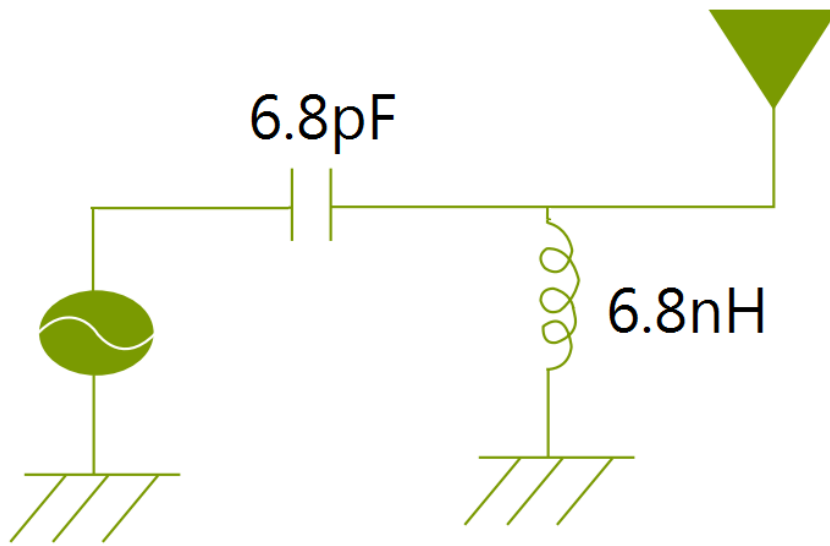

6. Drawing

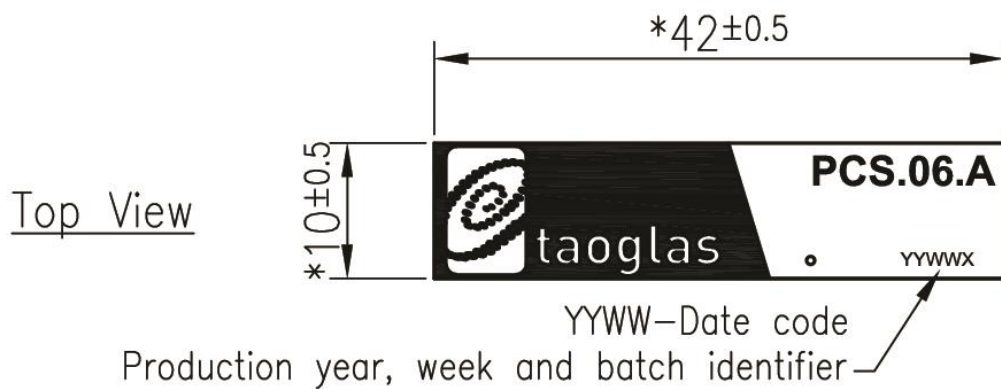

6.1. PCS.06.A Antenna

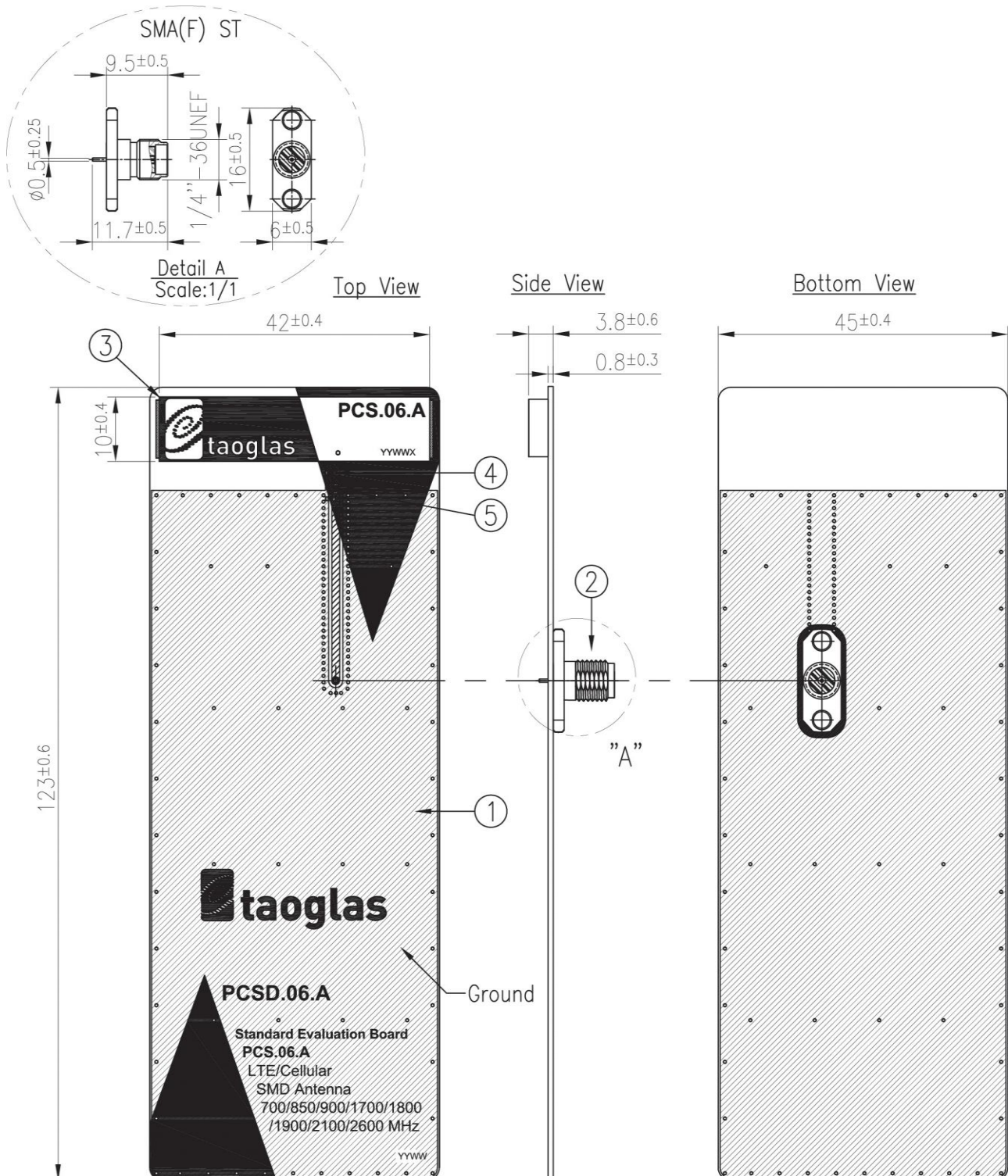

6.2. PCS.06.A Antenna with Evaluation Board



Note:



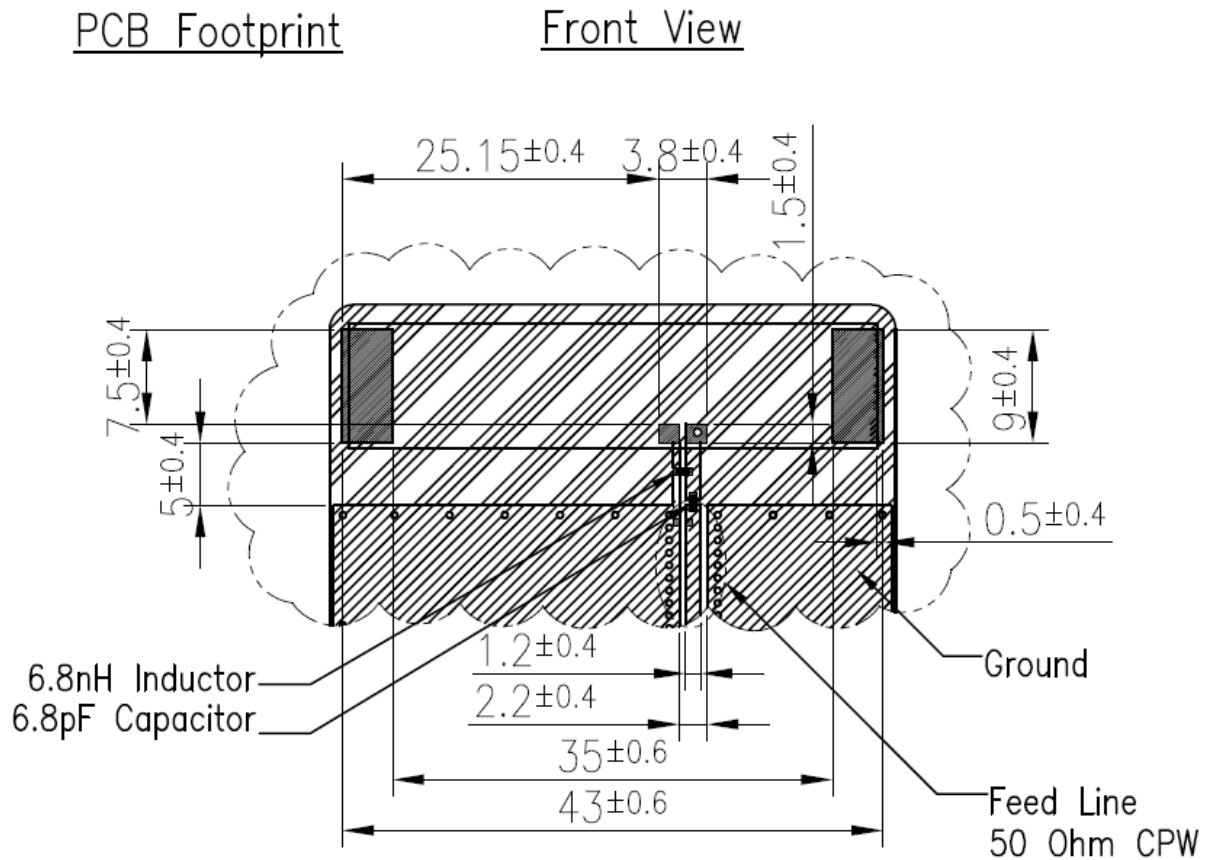

1. Week Batch Code
Example: 2013 Week 10=1310
2. Slodered area 
3. Copper area 
4. Logo & Text Ink Printing : Black
5. Ground Clearance Area 

	Name	Material	Finish	QTY
1	PCSD.06.A EVB PCB	Composite 0.8t	Au Plated	1
2	SMA(F) ST PCB	Brass	Au Plated	1
3	PCS.06.A PCB Antenna	High Temperature Composite 3t	Au Plated	1
4	6.8nH Inductor (0402)	Ceramic	N/A	1
5	6.8pF Capacitor (0402)	Ceramic	N/A	1

7. Antenna Footprint

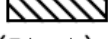

Notes:



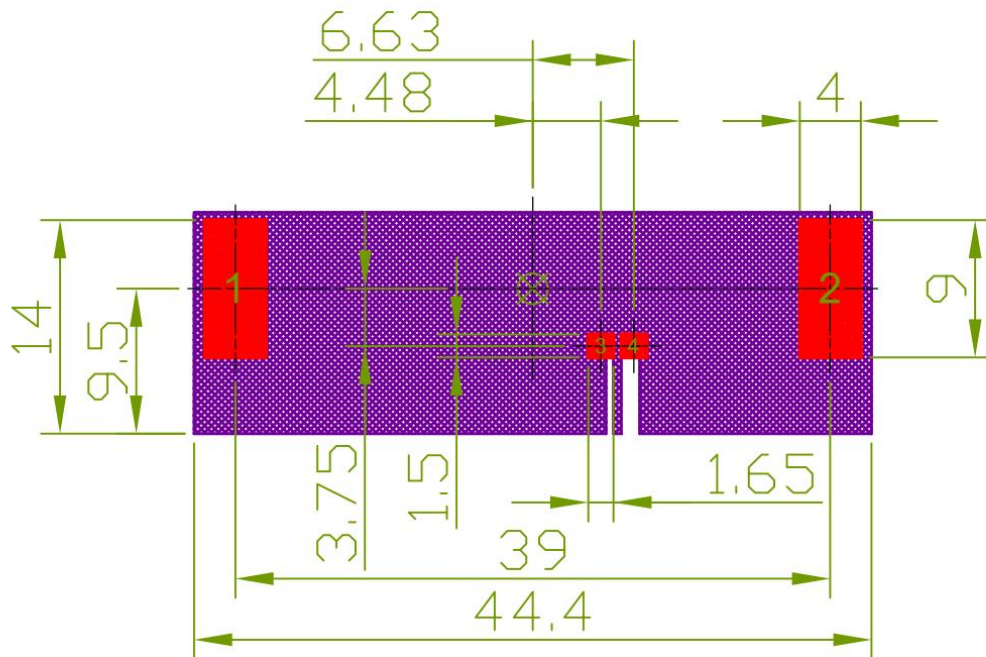

- Week Batch Code
Example: 2013 Week 10=1310
- Soldered area 
- Copper area 
- Ground Clearance Area 
- Tin Plated 
- Silkscreen (Black) 
- Soldermask (Gold) 
- Matching – Value Changes According To Ground And Layout.

7.1. Top Copper

Pads 1 and 2 are the same size, Pads 3 and 4 are the same size, Pad 4 should be connected to a 50 ohm transmission line.



NOTE:



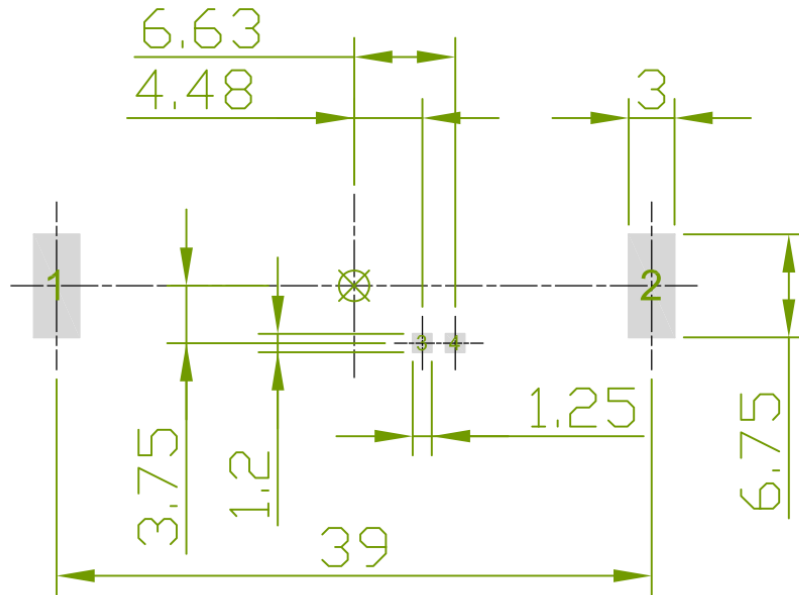

- | | | |
|------------------------|---|--|
| 1. Tin Plated area |  | 6. Ground keepout should extend through any inner PCB layers and any sides around the antenna till the board edge to minimize coupling from RF feed to ground, except the side facing system ground. |
| 2. Solder Mask area |  | 7. Any vias in pads should be either filled or tented to prevent solder from wicking away from the pad during reflow. |
| 3. Copper area |  | 8. The dimension tolerances should follow standard PCB manufacturing guidelines |
| 4. Paste area |  | 9. " * " Critical Dimensions. |
| 5. Keepout Region area |  | |

7.2. Top Solder Paste

Pads 1 and 2 are the same size, Pads 3 and 4 are the same size.



NOTE:

- | | | |
|------------------------|---|--|
| 1. Tin Plated area |  | 6. Ground keepout should extend through any inner PCB layers and any sides around the antenna till the board edge to minimize coupling from RF feed to ground, except the side facing system ground. |
| 2. Solder Mask area |  | 7. Any vias in pads should be either filled or tented to prevent solder from wicking away from the pad during reflow. |
| 3. Copper area |  | 8. The dimension tolerances should follow standard PCB manufacturing guidelines |
| 4. Paste area |  | 9. " * " Critical Dimensions. |
| 5. Keepout Region area |  | |

7.4. Composite Diagram

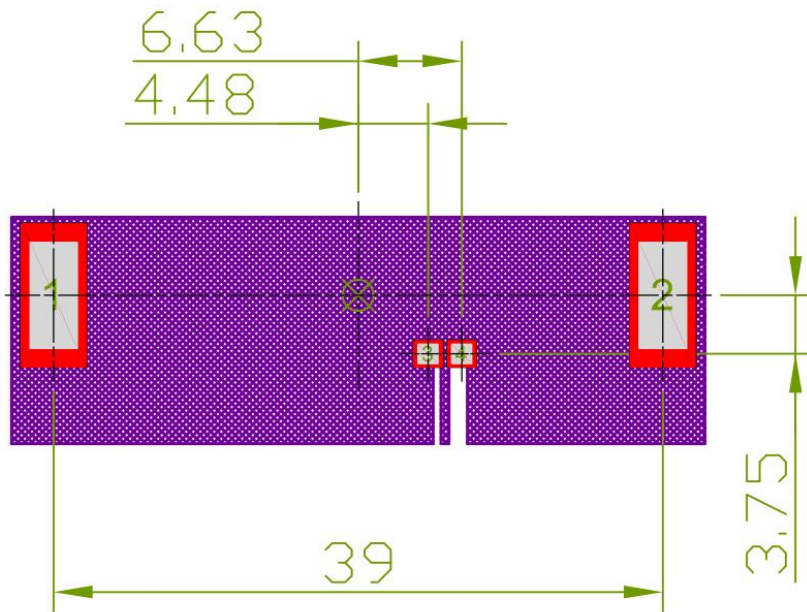

NOTE:

- 1. Tin Plated area
- 2. Solder Mask area
- 3. Copper area
- 4. Paste area
- 5. Keepout Region area
- 6. Ground keepout should extend through any inner PCB layers and any sides around the antenna till the board edge to minimize coupling from RF feed to ground, except the side facing system ground.
- 7. Any vias in pads should be either filled or tented to prevent solder from wicking away from the pad during reflow.
- 8. The dimension tolerances should follow standard PCB manufacturing guidelines
- 9. " * " Critical Dimensions.

8. Packaging

1000 pc PCS.06.A per reel
 Dimensions - Ø330*60mm
 Weight - 3230g

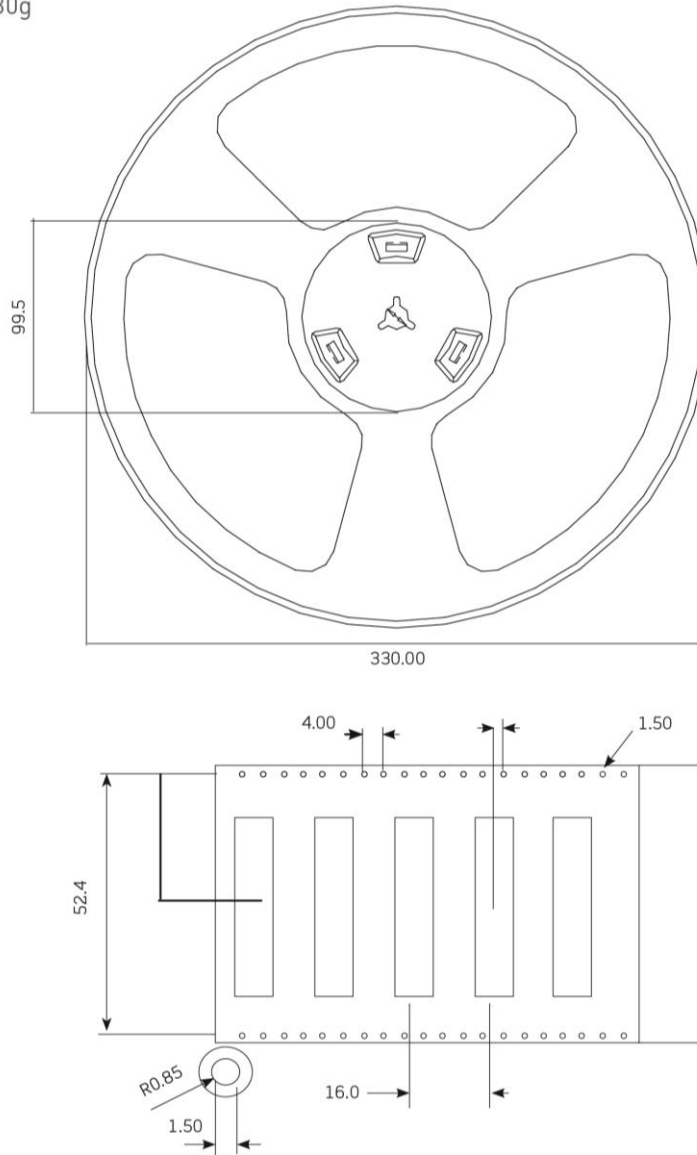

1000 pcs PCS.06.A reel
Dimensions - 330*330*60mm
Weight -3230g

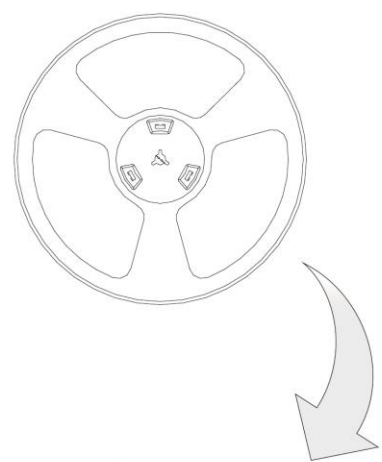

1000 pcs PCS.06.A / 1 Reel in small box
Dimensions - 340*340*90mm
Weight -3.5Kg

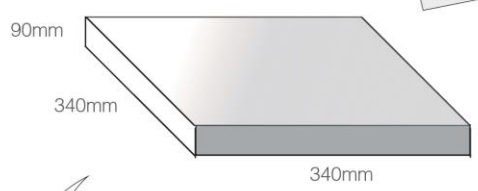

3 reels, 3000 pcs in one carton
Carton Dimensions - 370*360*275mm
Weight -11.3Kg

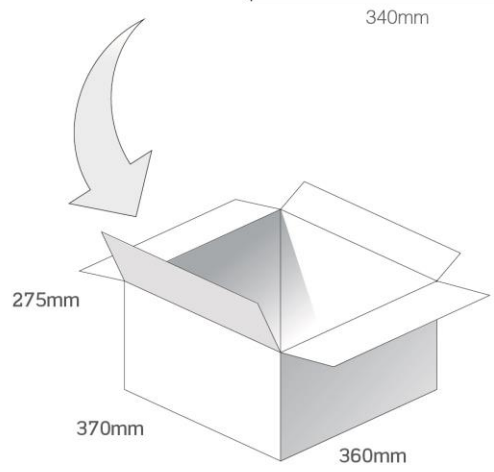

Pallet Dimensions 1200*1000*1320mm
24 Cartons per Pallet
6 Cartons per layer
4 Layers

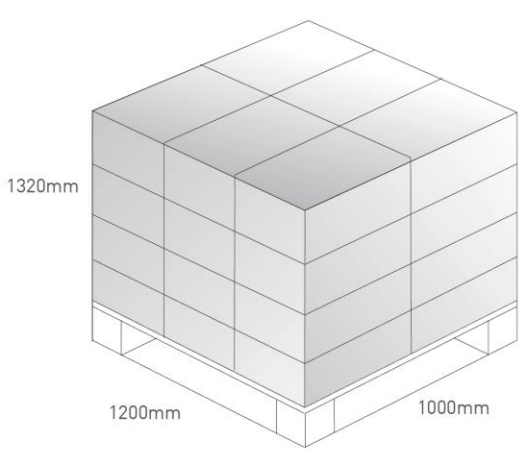

9. Application Note

Investigations of PCS.06.A antenna performance on different lengths of ground plane were conducted, the return loss is shown as below.

9.1. Return Loss

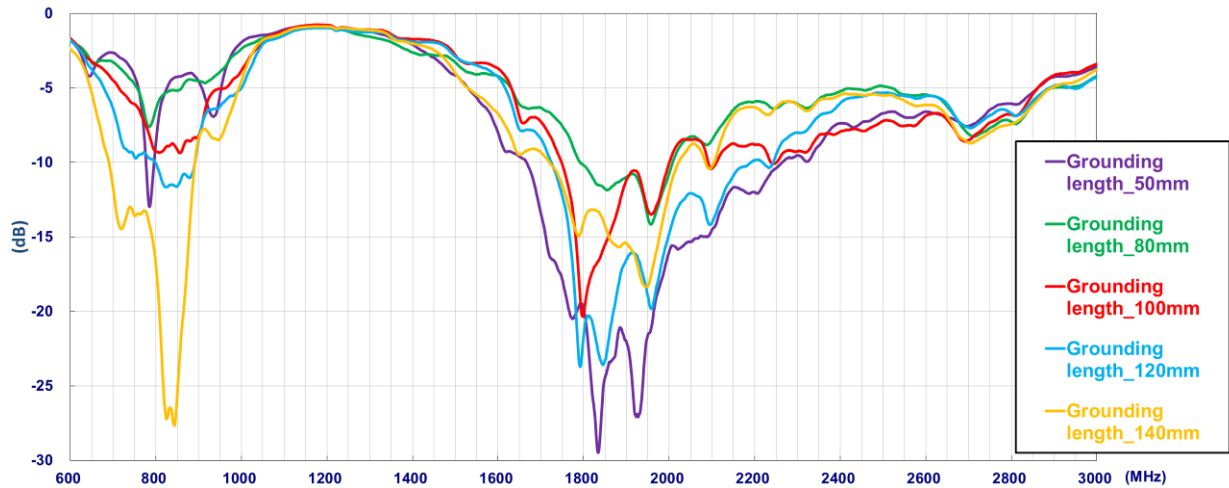

9.2. Efficiency

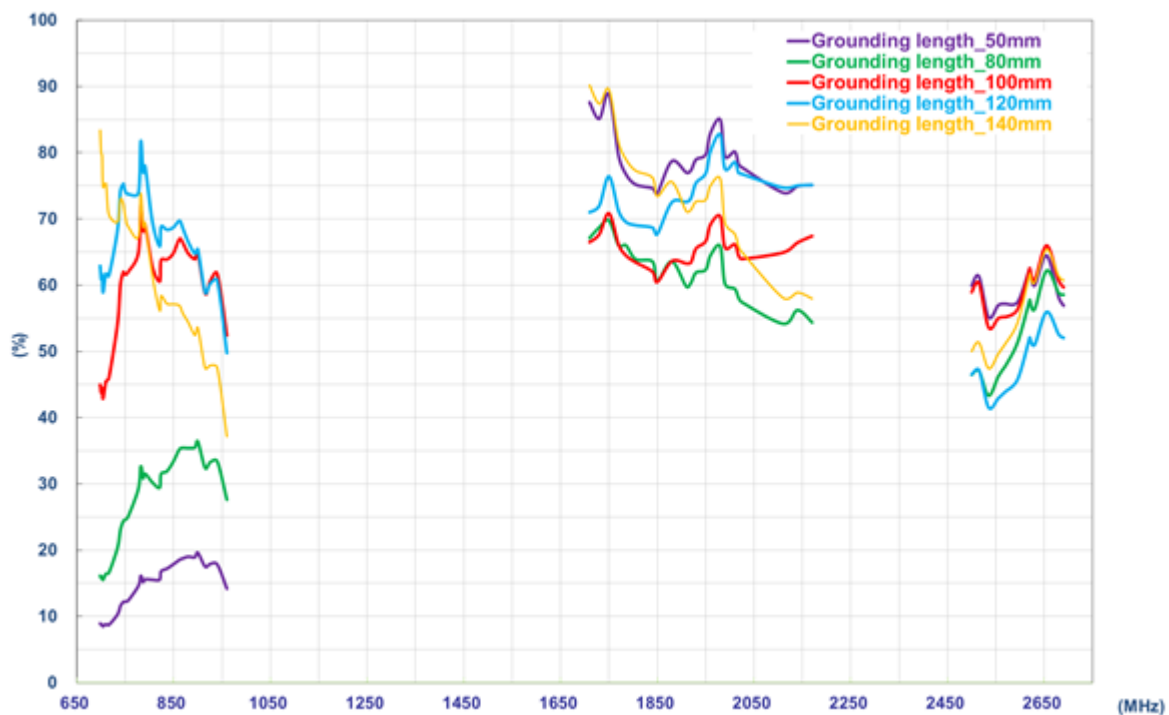

9.3. Peak Gain

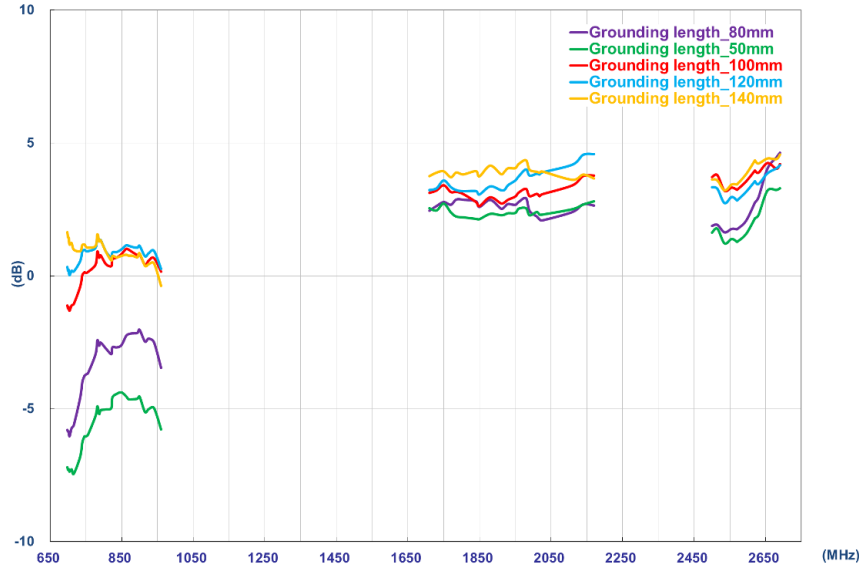

9.4. Average Gain

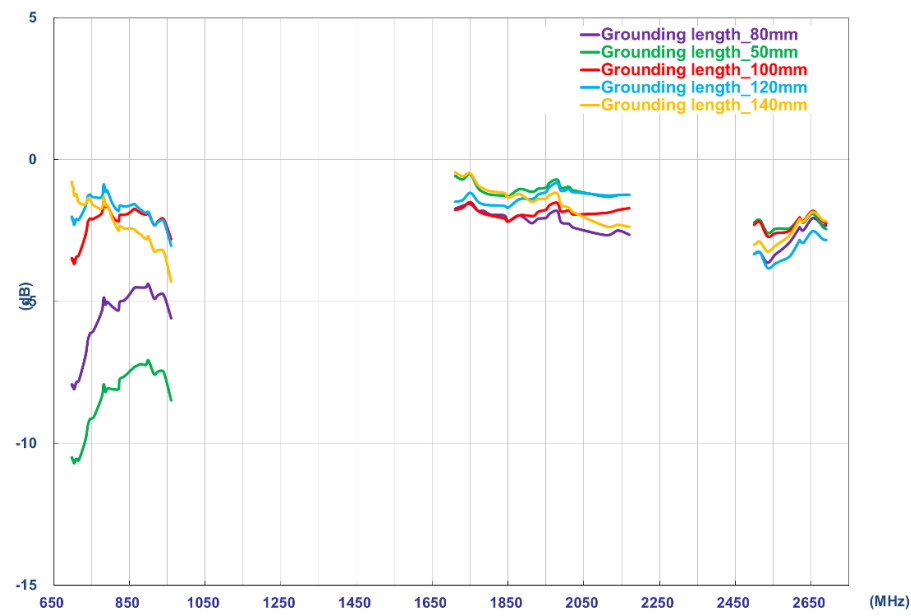

Taoglas makes no warranties based on the accuracy or completeness of the contents of this document and reserves the right to make changes to specifications and product descriptions at any time without notice. Taoglas reserves all rights to this document and the information contained herein.

Reproduction, use or disclosure to third parties without express permission is strictly prohibited.

Copyright © Taoglas Ltd.